

LEGEE 7

VACUUM-MOP 4 IN 1 ROBOT

FastBrush + Talent Clean + LEGEE SLAM

User Manual



iENA

Winner of Silver Medal at iENA
Germany Exhibition of inventions

◎ Important Safety Precautions

Please read all instructions before using.

The device can be used by children aged from 8 and above and persons with reduced physical, sensory or mental capabilities or lack of experience and knowledge if they have been given supervision or instruction concerning use of the device in a safe way and understand the hazards involved. Children shall not play with the device. Cleaning and user maintenance shall not be made by children without supervision.

Warning:

Do not expose LEGEE or its accessories' electronics parts. Should the product become damaged or need replacing at any time, all service or repairs must be carried out by an authorized service agent. Please ensure electrical input voltage is compatible with the charging station.

- Follow all instructions and warnings.
- After reading this manual, please keep it in an easily accessible location.
- Please clean the cliff sensors and side brush before use.
- Place the cleaning cloth under the device flatly before use.
- Only fill the water tank with water or diluted LEGEE detergent, other detergents are not allowed.
- Avoid using the device on greasy surface.
- Clear electrical cords, body parts and curtains away when using the device.
- Keep the device and accessories away from children.
- Keep the device in dry and cool place, away from direct sunlight, naked flames, heat, humidity, water and any other liquids.
- Do not store the device near oil, combustible spray or flammable materials.
- Product operating temperatures: 0°C ~40°C (32°F ~104°F)
- Product storage temperatures: -10°C ~50°C (14°F ~122°F)

◎ Safety Warnings

- Connect the power adapter to a power source that matches the specifications. The power adapter is designed for connection to hazardous electrical voltages. Do not attempt to repair the adapter. Replace the whole unit if it is damaged or exposed to high moisture. Consult local HOBOT dealer for help and maintenance.
- Make sure the device, power adapter and charging station are not trapped under heavy objects.

- Allow adequate ventilation around the device, power adapter and charging station. Do not cover them with objects.
- Do not use the device, power adapter and charging station in a strong magnetic field, humid or high heat environment.
- Please use the original power adapter, battery and charging station that came with the device. Use any third-party components may result in damage, malfunction and/or danger.
- This device contains batteries that are not replaceable.
- Battery can explode, catch fire, and/or cause burns if disassembled, crushed, cut, punctured, short-circuited, incinerated, recharged (disposable cells), or exposed to water, fire, or temperatures above 60°C (140°F).
- If the device is not in use for a long period of time, store it in a dry and safe location. The battery will need to be charged every 3 months to maintain battery life.
- Never operate this device if the cord or power adapter is damaged. Ensure the power cord is not stretched or exposed to sharp object or edges.
- Do not use the device if any part or any accessory is damaged or defective.
- Before using the device, remove any fragile objects from the floor e.g. glass pieces or any other objects that could block or damage the device.
- Do not leave any fragile objects on the side of the tables, cabinets etc. where the device could bump into and cause them to fall.
- Switch off the power and disconnect the power plug before dismantling, assembling or cleaning the device, power adapter and charging station.
- Do not clean the unit by spraying it or immersing it in water. The device is not waterproof.
- Any service other than regular cleaning should be only performed by an authorized service representative.
- Contact your local waste management authority to follow local disposal regulations and never dispose the device and rechargeable batteries with normal household waste.

©Copyright & Trademarks

Copyright © 2020 by HOBOT® Technology Inc. All rights reserved.

No part of this publication may be reproduced, transmitted, transcribed, stored in a retrieval system or translated into any language or computer language, in any form or by any means, electronic, mechanical, magnetic, optical, chemical, manual or otherwise, without the prior written permission of this company.

All other logos, products, or company names mentioned in this manual may be the registered trademarks or copyrights of their respective companies, and are used for informational purposes only.

©Disclaimer

HOBOT Technology Inc. makes no claims or warranties, either expressed or implied, with respect to the contents hereof and specifically disclaims any warranties, tradability or suitability for any particular purpose. Furthermore, HOBOT Technology Inc. reserves the right to revise this publication and to make changes from time to time in the contents hereof without obligation of this company to provide notification of such revisions or changes. The user should follow the instructions provided in this user manual, but is ultimately responsible for assessing placement and safety when using this cleaning tool.

©Laser Safety

The laser distance sensor of this product meets the standards for Class I Laser Products in IEC 60825-1:2014 and will not generate hazardous laser radiation.

©Limited Warranty

If there are defects in your LEGEE due to faulty materials, poor workmanship, or malfunction within the warranty period from the date of purchase or delivery, please immediately contact a local retailer or local authorized dealer for repairs or replacement. This limited warranty does not cover:

- Normal wear and tear, including parts that might wear out over time (e.g. side brush, cleaning cloth, caterpillar belt, spray nozzle and filter, etc.)
- Reduction in battery runtime due to battery age or use, as the life of the battery and number of times the device is used.
- Transit, delivery or accidental damage or misuse and abuse that is not in accordance with the instructions.
- Faults or damage caused by:
 - Negligent use, misuse, abuse or careless operation of the device.
 - Use of the device which is not in accordance with this manual.
 - Use of anything other than normal domestic household purposes in the country in which it was purchased.
 - Use of parts not assembled or installed in accordance with this instruction.
 - Use of any unauthorized parts and accessories. Please contact a local retailer or local authorized dealer for spares and accessories.
 - Faulty assembly or installation.
 - Repairs or alterations carried out by parties other than HOBOT authorized dealer.

◎Product Features

Exclusive Patent License: FastBrush 4-Stage Cleaning

FastBrush 4-stage cleaning allows LEGEE to complete vacuum, dry mopping, water spray and wet mopping in one take.

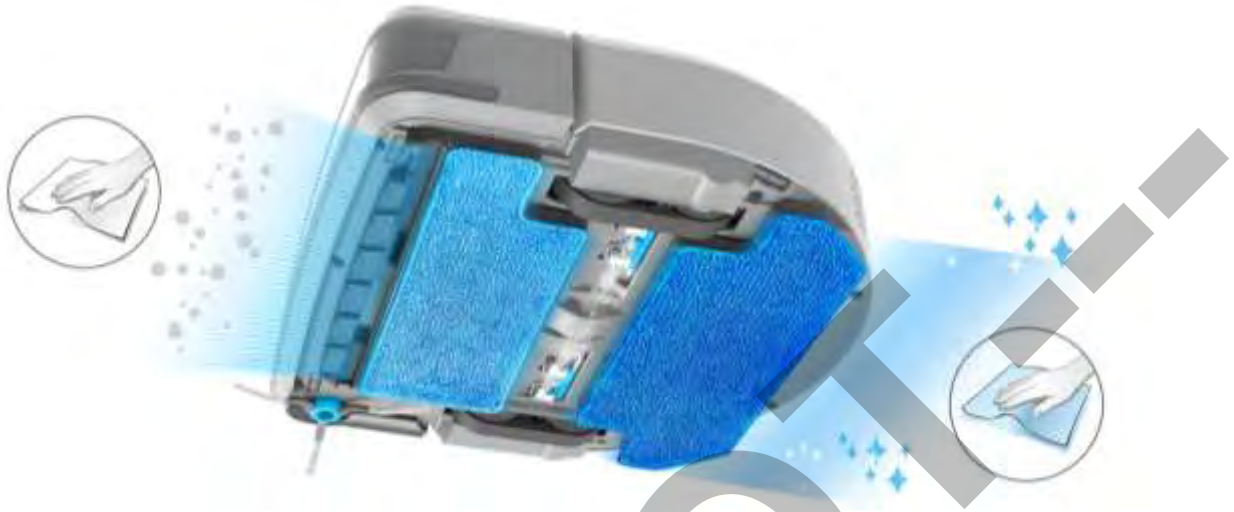

LEGEE has the powerful 2700Pa vacuum power to pick up small particles such as fine dusts and hair; and the reciprocating moving mechanism to imitate the human behavior by applying the maximum 900 times/min mopping speed with 1800g mopping force against the floor to remove the stubborn dust and stain. Followed by the quad smart water sprayer that is equipped with temperature sensor that evenly sprays just enough water to dissolve the stains but not leave the water residue behind. The rear cleaning cloth which also shares the same movement with the front cleaning cloth finally finishes cleaning by absorbing the dissolved stains and polishing the floor.



LEGEE SLAM Navigation



LEGEE SLAM is the abbreviation of the unique navigation system that integrates Lidar, Encoder, Gyro, E-compass and Position Estimation. The advanced LDS sensor collects the high accuracy terrain information for LEGEE to optimize the cleaning process. LEGEE will clean the floor in 4.4×4.4 meter² sequence and optimize the recharge & resume time to complete the task efficiently.



There are 7 Talent Clean modes: Standard, Strong, ECO, Stain Remover, Dry, Pet and Polish; 1 customized mode for you to serve any special needs. To Achieve the best cleaning result, you can assign different Talent modes in accordance to the room condition.

Mode	Introduction
 Stain Remover	HOBOT exclusive patent. Specialized to clean the stubborn stains we often left behind on the floor. LEGEE will first divide the area to 1.5×1.5 m ² and spray generous amount of water to dissolve the stains, then go back to mop and absorb the dissolved stains, the floor will be world-class clean!
 Pet	Cleaning pets' hair haven't been easier! Under pet mode, the vacuum power is increased to collect light hairs. Also, the increased water spray volume and higher mopping frequency can remove pawprints or stains on the floor.
 Polish	LEGEE will clean the floor by increasing water spray volume and mopping frequency while lowering moving speed to remove old dirt and water marks on the floor, your floor will soon be restored to bright and shine!

©About LEGEE 7

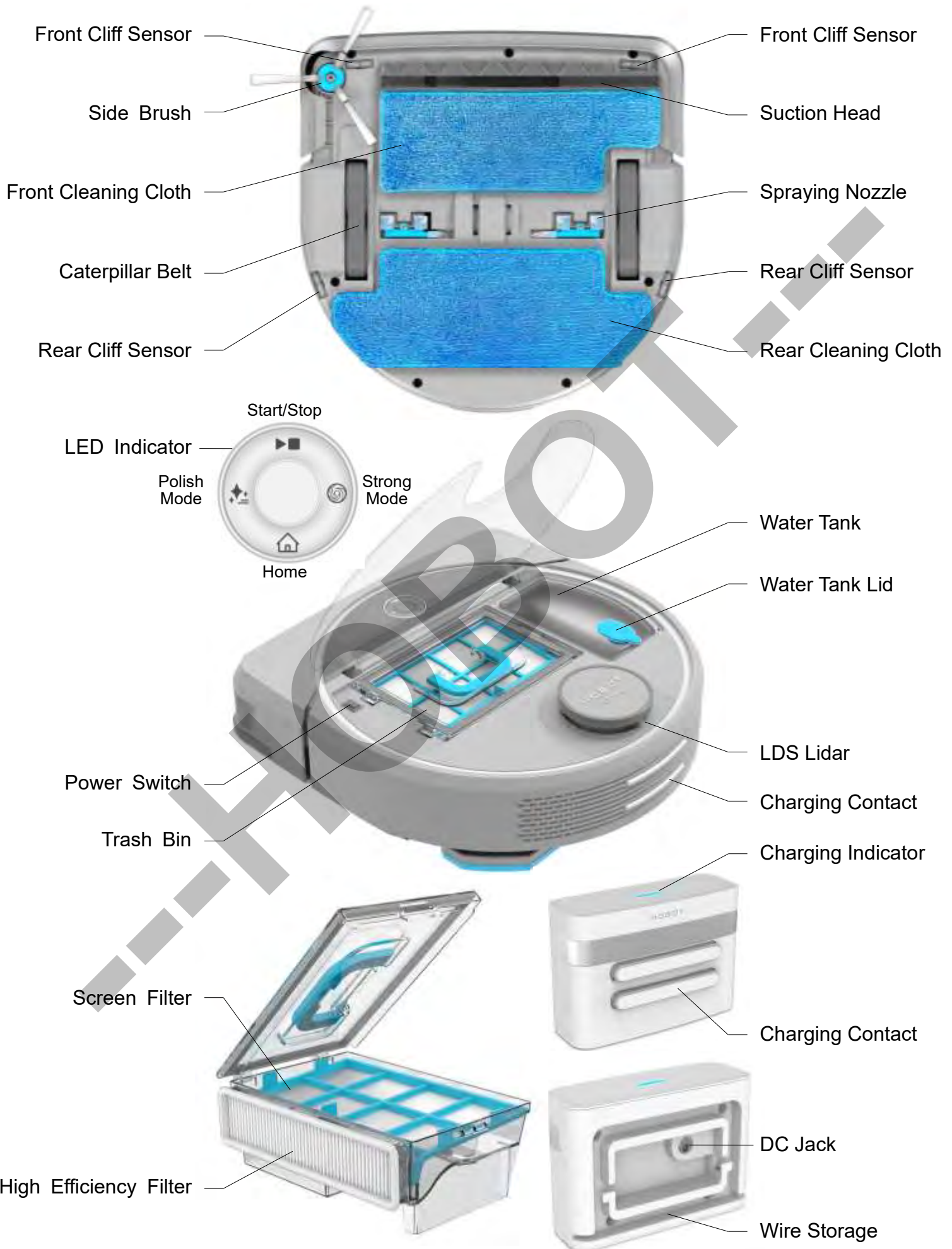

◎Getting Ready

1. Install Charging Station and Waterproof Mat

- Step 1. Place the charging station against a wall on hard surface flooring to prevent sliding when charging.
- Step 2. Clear the objects at least 1.5 meter in front and 1.5 meter to the right and left of the charging station.
- Step 3. Place the waterproof mat right against the wall, under the charging station.



2. Charging your LEGEE

- Step 1. Connect the power adapter into the charging station.
- Step 2. Place the round end of the robot against the metal contacts on the station. Before the first time of use, fully charge the battery for at least 6 hours until green light is ON.

3. Attach / Change Cleaning Cloth

Attach the cleaning cloth to the mopping pad flatly. (as indicated in the illustration)

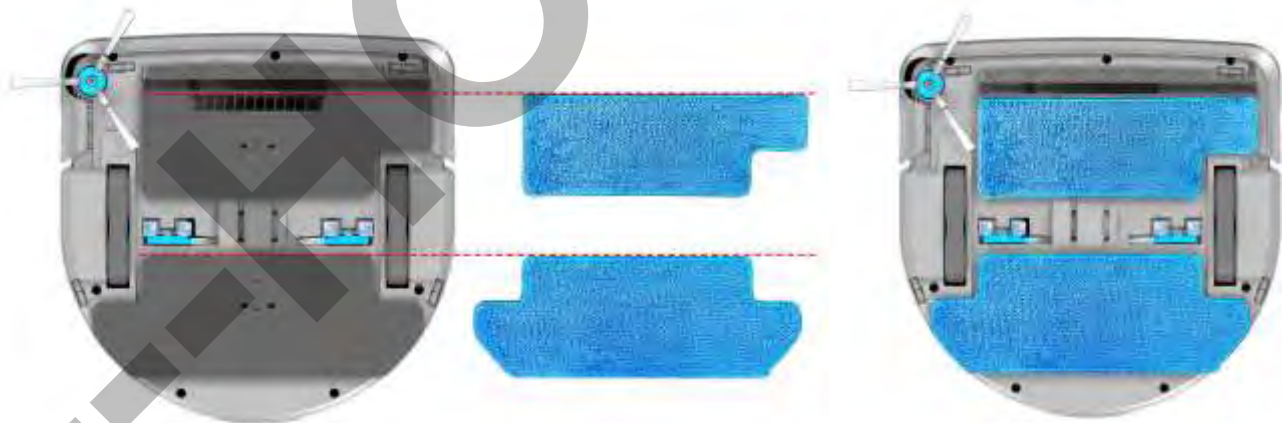

4. Install Side Brush

Press the side brush to install until hearing the click sound.



5. Fill Water/Detergent

Fill water or LEGEE detergent to the water tank by using the supplied bottle and seal the water tank with the plug after filling.

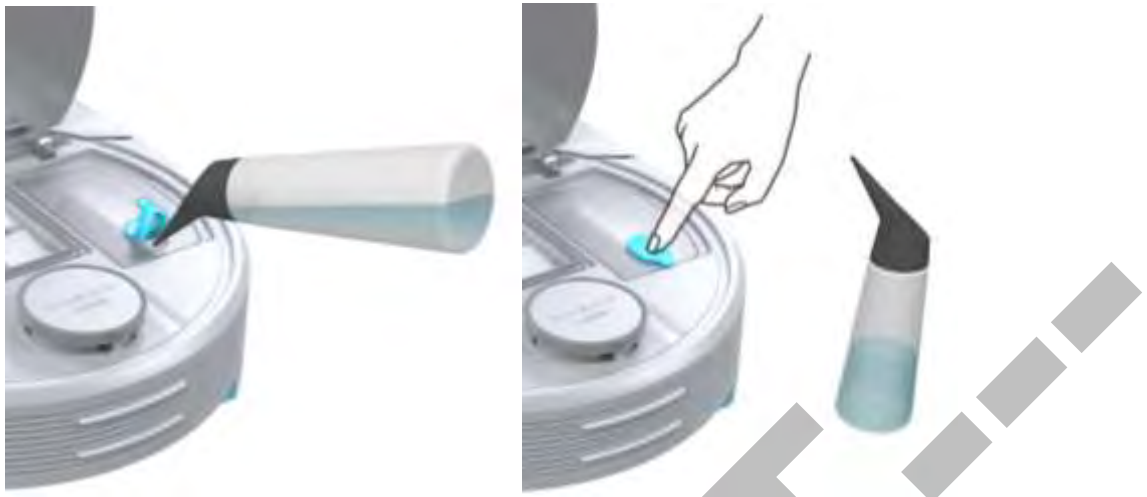

6. Start/Stop Cleaning

Step 1. Start cleaning: Lift open the cover and press down the power switch, then close the cover and press  on LEGEE or App.

Step 2. Pause cleaning: Press  on LEGEE or App

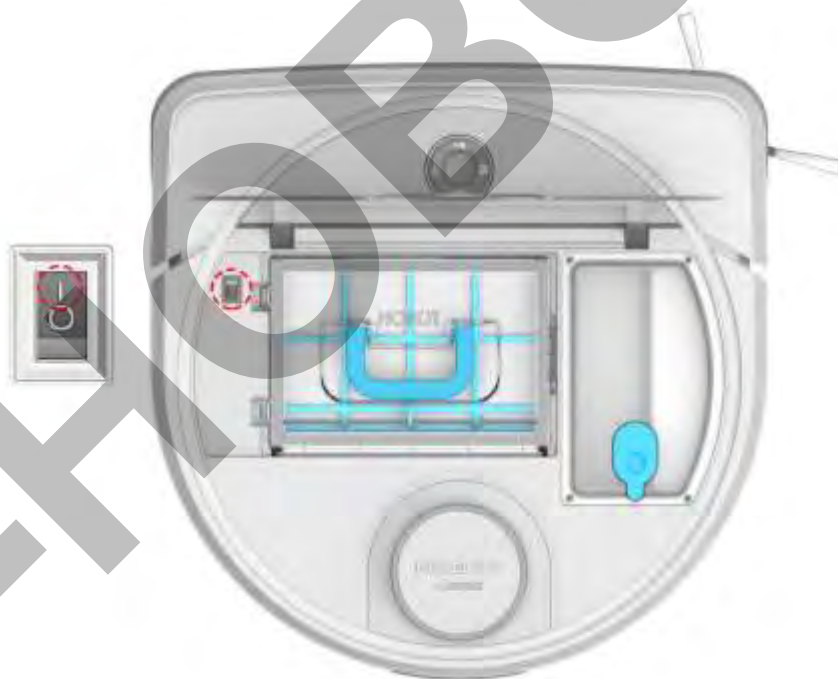

7. Take off the damp cleaning cloth

Please take off the damp cleaning cloth after cleaning to avoid odor after long contacting.

App Instructions

LEGEE 7 can be dynamically controlled by HOBOT LEGEE App through Wi-Fi.



1. Download and Install HOBOT LEGEE App

* **Please read and agree to our Terms of Service.**

- LEGEE supports 2.4G and 5G Wi-Fi connection.
- Please turn on the Bluetooth function on your smartphone.
- Please only turn on the power of the LEGEE you want to connect.
- Please make sure LEGEE and the smartphone are both under the same Wi-Fi network with consistent Wi-Fi coverage.
- Please turn on Wi-Fi function on your smartphone and connect.

2. HOBOT Account

HOBOT account will only store LEGEE's device initial name, while all the data in the schedule queue, cleaning diary, memorized maps and all customized setting are stored in LEGEE and will never be accessed via HOBOT account. When you log in to your HOBOT account in another smartphone, HOBOT account will help you to link to the devices (except LEGEE-688) that associate to your HOBOT account and retrieve the data stored in your LEGEE for you.

3. Start Cleaning with HOBOT LEGEE App

Step 1. Lift open the cover and press down the power switch.

Step 2. Tap any Talent Clean mode.

Step 3. Tap  to proceed.

Step 4. Tap  to start cleaning.

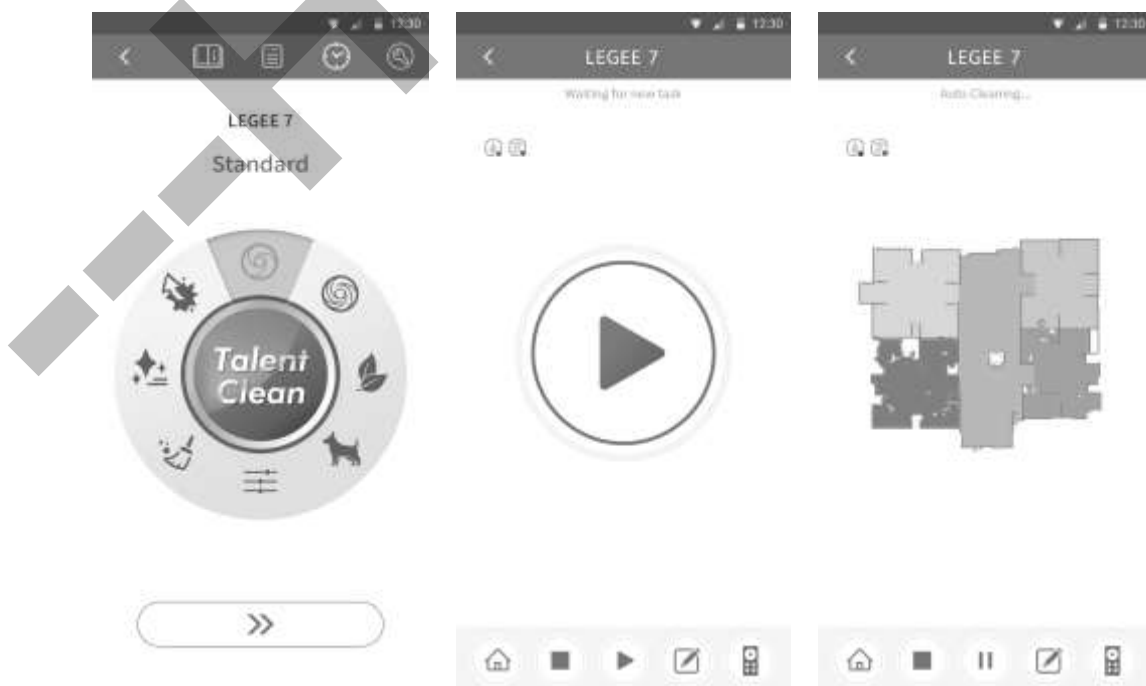

⊙ Cleaning & Maintenance

1. Clean the Cliff Laser Sensors

Use a clean, dry soft cloth or to clean the cliff sensors. (as indicated in the illustration)

Care Frequency: Before each use or follow App's reminder.

2. Empty the Trash Bin

Take out the trash bin by lifting the top handle. Open the trash bin and remove the filters to dump the dust.

Care Frequency: After each use or follow App's reminder.

3. Clean the Screen Filter

- Gently shake off the fine dust from the screen filter.
- Please rinse the screen filter if needed, please leave it dry before reinstall.

Care Frequency: After each use.

4. Clean the High Efficiency Filter

- Gently shake off the fine dust from the high efficiency filter.
- Please rinse the high efficiency filter if needed, please leave it dry before reinstall.
- Please replace high efficiency filter if it is too dirty.

Care Frequency: After each use.

Please contact a local retailer or local authorized dealer for additional consumable spare parts.

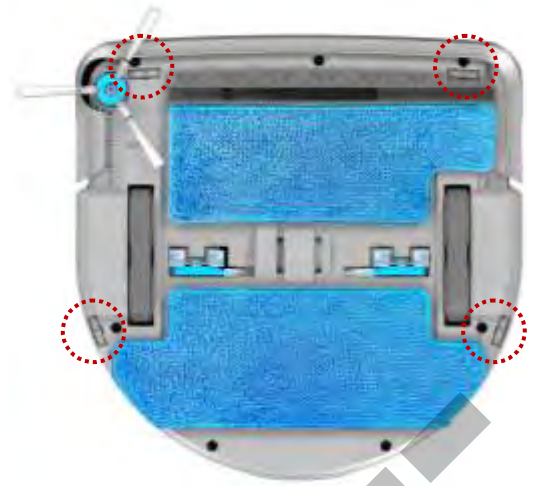

5. Clean the Side Brush

Step 1. Pull off the side brush, then gently rub the side brush with warm water to clean the dirt off and restore it to its original shape.

Step 2. Reinstall the side brush.

Care Frequency: After each use.

Please contact a local retailer or local authorized dealer for additional consumable spare parts.

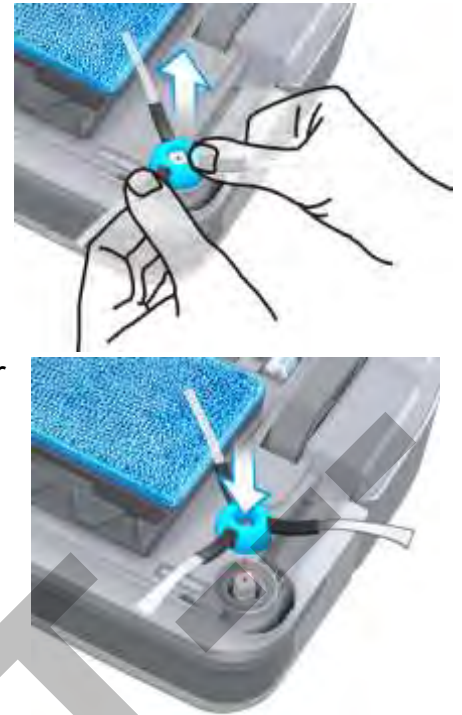

6. Cleaning Cloth Care Instructions

Wash with detergent to remove odor and lay flat to dry.

- Washing under 40°C (104°F).
- Do not bleach.
- Do not tumble-dry.
- Do not iron.
- Do not dry clean.

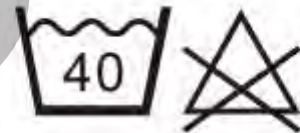

Care Frequency: After each use.

Please contact a local retailer or local authorized dealer for additional consumable spare parts.

7. Adjust the Bumper

Step 1. Press the right side of the bumper and then pull the left side of the bumper out to detach it from LEGEE.

Step 2. Wipe clean the bumper and restore it to the original position.

Care Frequency: When LEGEE is moving abnormal.

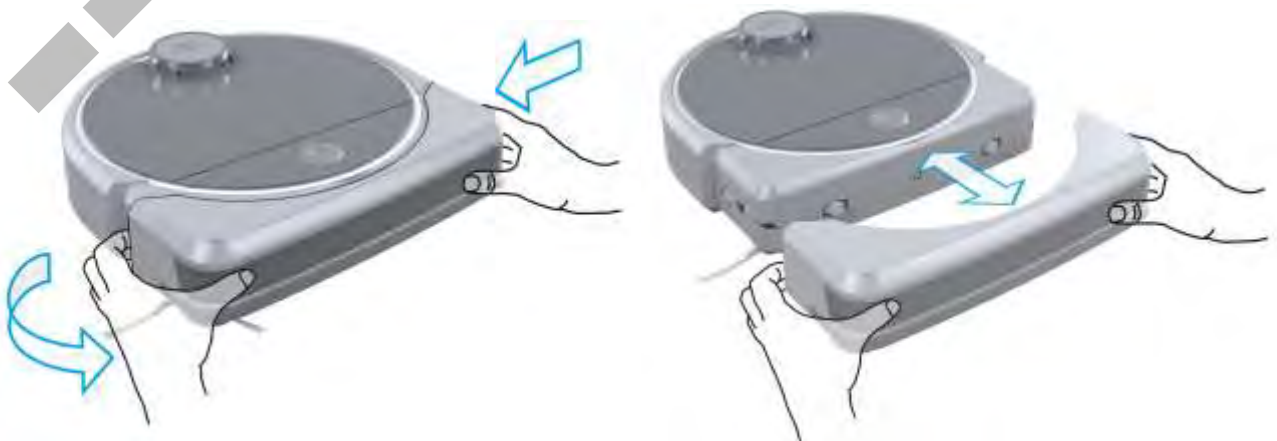

8. Unclog the Spraying Nozzle

Use the push pin to poke the center of the spraying nozzle to remove water residue.

Care Frequency: When nozzle is clogged and cannot spray water.

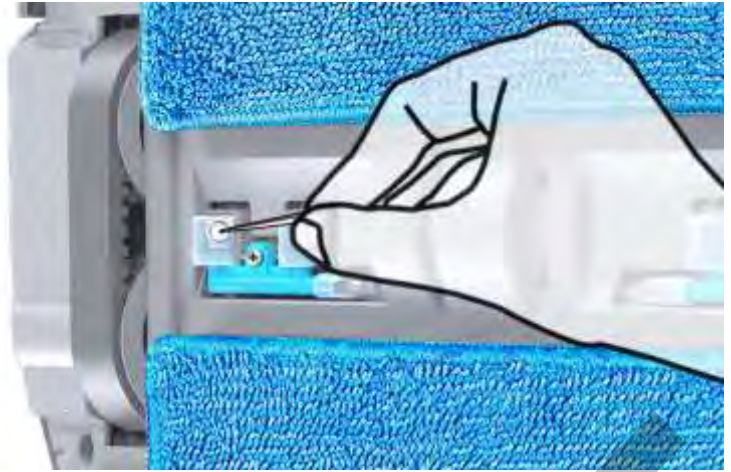

9. Replace the Spraying Nozzle

Use a small screwdriver to remove the screw and nozzle. Replace with new nozzle and screw it back.

Care Frequency: When nozzle is clogged and cannot spray water.
Please contact a local retailer or local authorized dealer for additional consumable spare parts.

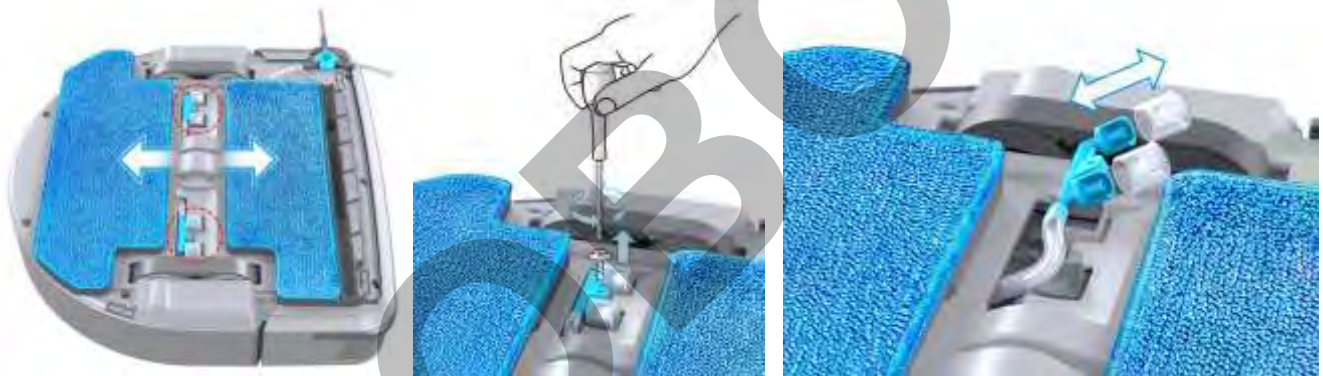

©LED Indication

Situation	LED Indication
Dry mopping	White light on
Wet mopping	Blue light on
Spraying water	White and blue light flashing
Low battery	Orange light flashing
Searching for charging station	Orange and blue light flashing
Battery charging	Orange light on
Battery fully charged	Green light on
Warning	Light is off with voice prompt
Connecting	White light flashing

© Frequently Asked Questions (FAQ)

Case	Solution
1. Can't be switched on	Check if the battery has been charged.
2. LEGEE cannot return to the charging station	Check if the adapter has been properly connected to the charging station and it has been plugged into the power socket. Clear the objects around the charging station.
3. Poor contact with charge contacts	Please switch off the power and remove the power source from the charging station. Clean all charging contacts by using a clean cloth with rubbing alcohol to remove oxide.
4. Avoid charging interruption	It is advised to keep LEGEE switched on when charging, LEGEE will be able to return to the charging station automatically in case LEGEE is slightly moved.
5. The power consumption is very low when LEGEE is standing by, letting LEGEE stay connected to the charging station can help to maintain the battery's best performance.	
6. The cleaning result is less satisfying	Switch off power, then clean or change the side brush, the trash bin, high efficiency filter and the cleaning cloth.
7. Works/moves abnormally	Switch off power, clean the side brush then clean cliff sensors. Also check if the bumper is properly installed.
8. The side brush does not spin	Switch off power, then check if the side brush is jammed. Clean the side brush and then reinstall it.
9. LEGEE does not spray water	Test the spraying nozzles, if clogged, please clean or replace them.
10. Testing spray nozzles	Press  on the App will make LEGEE to spray once.
11. How to make LEGEE to clean more efficiently	Please clear the clutter, rugs, power cords, draperies before cleaning.
12. Unable to link to App/LEGEE when connecting	Please restart LEGEE and App. a) Weak Wi-Fi signal, please make sure LEGEE and the smartphone are both in the same area with consistent Wi-Fi coverage. b) Please update HOBOT LEGEE App and try again. c) Wrong password.
13. Unable to link to App/LEGEE	Please restart LEGEE and App. a) Weak Wi-Fi signal, please make sure LEGEE and the smartphone are both under consistent Wi-Fi coverage. b) Please update HOBOT LEGEE App and try again. c) If LEGEE has been moved to a different wireless network, please re-pair LEGEE with the App before use.
14. LEGEE does not clean as scheduled	LEGEE must be switched on and not under low battery status or under Do not Disturb mode to proceed scheduled cleaning.

If any problems occur and this manual cannot provide the solution you need, please contact a local retailer or local authorized dealer.

◎ Specifications

Model No.	LEGEE 7
WiFi	802.11a/b/g/n/bt
Battery	Li-ion 4500 mAh
Device size (L×W×H)	340×339×100 mm (13.4×13.3×3.9 in)
Charging Station	
Input voltage	100-240 VAC, 50-60 Hz
Power consumption	19V/1.05A, 19.95W

◎ Product and Accessories

LEGEE 7	Charging station
AC adapter	User manual
Water bottle	Side brushes
Microfiber cleaning cloth	High efficiency filter
Spray nozzles pack	Waterproof mat



HOBOT Technology Inc.
www.hobot.com.tw