

Description

Relieving, 1-7/8" Wide

W&H Item #

2803

Printing may distort actual profile measurement. Print in "Actual Size", outer border should measure 8" x 10-1/2"

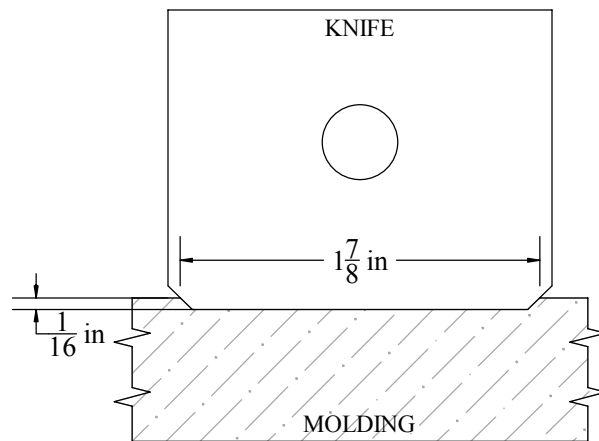
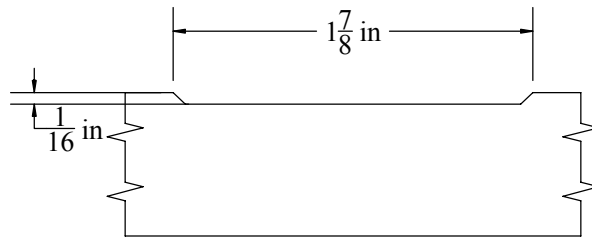

**WILLIAMS & HUSSEY  
MACHINE CO**  
105 State Route 101A, Unit 4  
Amherst, NH 03031

800-258-1380 or 603-732-0219  
Fax 603-732-4048  
[www.williamsnhussey.com](http://www.williamsnhussey.com)  
[customerservice@williamsnhussey.com](mailto:customerservice@williamsnhussey.com)

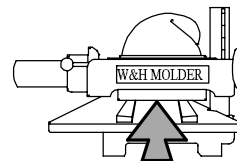

**KNIFE ORIENTATION  
SHOWN FROM  
THE INFEEED SIDE  
OF MOLDER**