

Description	CASING, 2-3/4" Wide Center Profile	W&H Item #	2310-CP
-------------	---------------------------------------	------------	---------

Printing may distort actual profile measurement. Print in "Actual Size", outer border should measure 8" x 10-1/2"

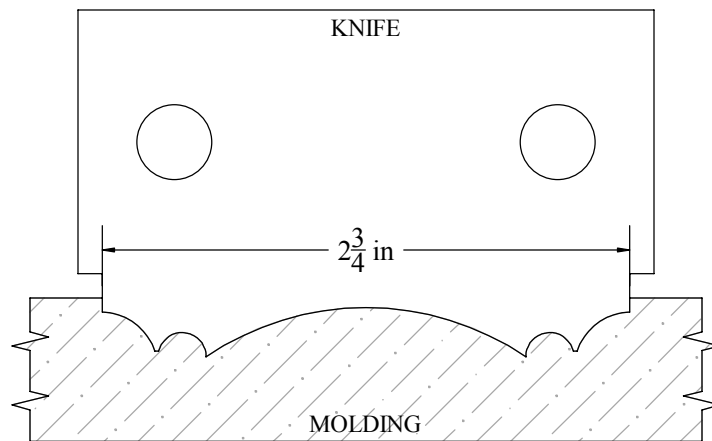
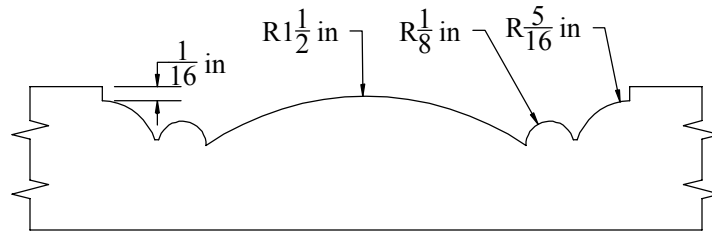

End Profile / Center Profile Advantage!

W&H End Profile (EP) and Center Profile (CP) knives are designed to cut stock on various width boards, eliminating knife line marks



**WILLIAMS & HUSSEY
MACHINE CO**
105 State Route 101A, Unit 4
Amherst, NH 03031

800-258-1380 or 603-732-0219
Fax 603-732-4048
www.williamsnhussey.com
customerservice@williamsnhussey.com

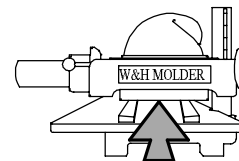

**KNIFE ORIENTATION
SHOWN FROM
THE INFEED
SIDE
OF MOLDER**