

Description

CASING, 5/8" x 2-1/4"

W&H Item #

2303

Printing may distort actual profile measurement. Print in "Actual Size", outer border should measure 8" x 10-1/2"

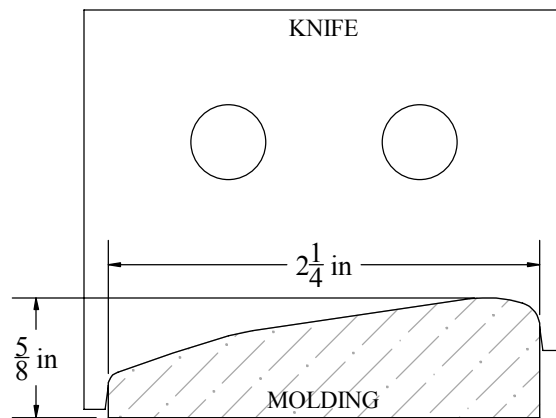
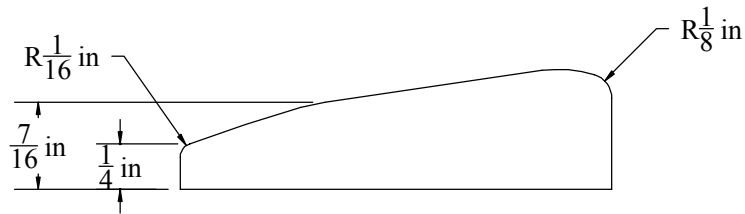

WILLIAMS & HUSSEY  
MACHINE CO  
105 State Route 101A, Unit 4  
Amherst, NH 03031

800-258-1380 or 603-732-0219  
Fax 603-732-4048  
www.williamsnhussey.com  
customerservice@williamsnhussey.com

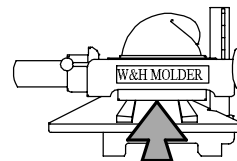

KNIFE ORIENTATION  
SHOWN FROM  
THE INFEEED SIDE  
OF MOLDER