

Description

CASING, 11/16" x 2-1/2"

W&H Item #

2283

Printing may distort actual profile measurement. Print in "Actual Size", outer border should measure 8" x 10-1/2"

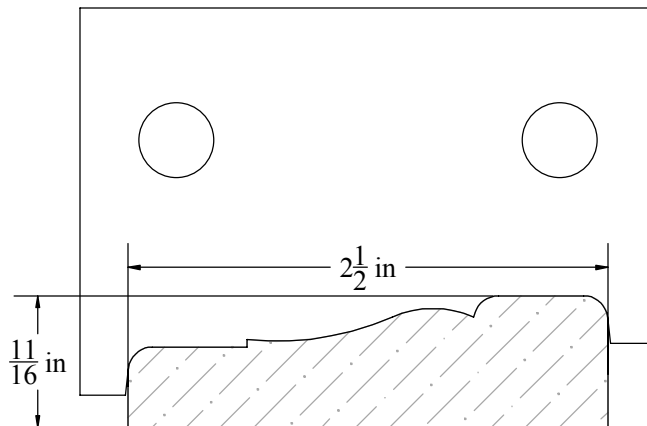
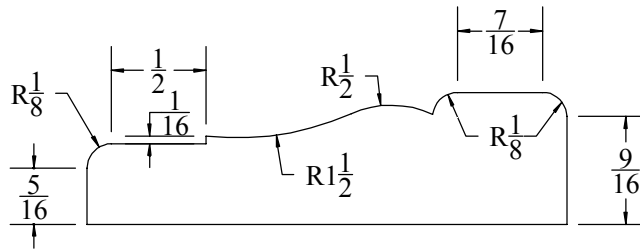

WILLIAMS & HUSSEY
MACHINE CO
105 State Route 101A, Unit 4
Amherst, NH 03031

800-258-1380 or 603-732-0219
Fax 603-732-4048
www.williamsnhussey.com
customerservice@williamsnhussey.com

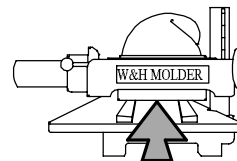

KNIFE ORIENTATION
SHOWN FROM
THE INFEEED SIDE
OF MOLDER