

Description

CROWN, Top, 7/8" x 4-3/4"

W&H Item #

2072-T

Printing may distort actual profile measurement. Print in "Actual Size", outer border should measure 8" x 10-1/2"

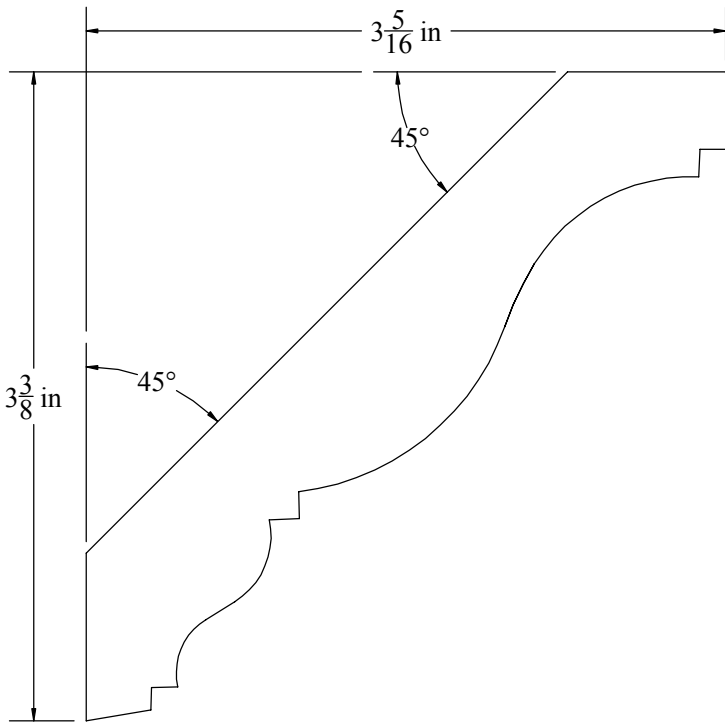

When using both W&H Top & Bottom profile knives, cut the bottom (angle) profile first. The opposite applies if using a table saw for the back angle cuts. Cut the top profile on the molder and then cut the angles on a table saw.

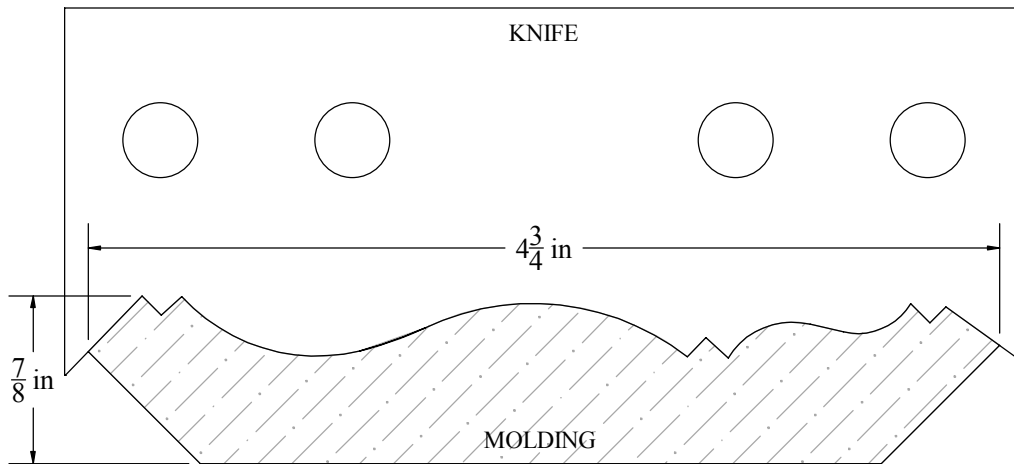
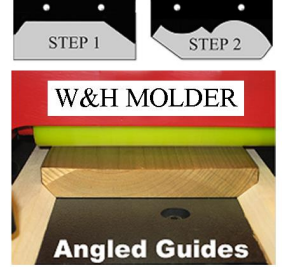

**WILLIAMS & HUSSEY
MACHINE CO**
105 State Route 101A, Unit 4
Amherst, NH 03031

800-258-1380 or 603-732-0219
Fax 603-732-4048
www.williamsnhussey.com
customerservice@williamsnhussey.com

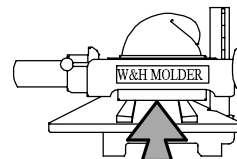

**KNIFE ORIENTATION
SHOWN FROM
THE INFEEED SIDE
OF MOLDER**