

Email: [support@turboant.com](mailto:support@turboant.com)  
Website: [www.turboant.com](http://www.turboant.com)  
Made in China





# Folding Electric Scooter

## X7 Max

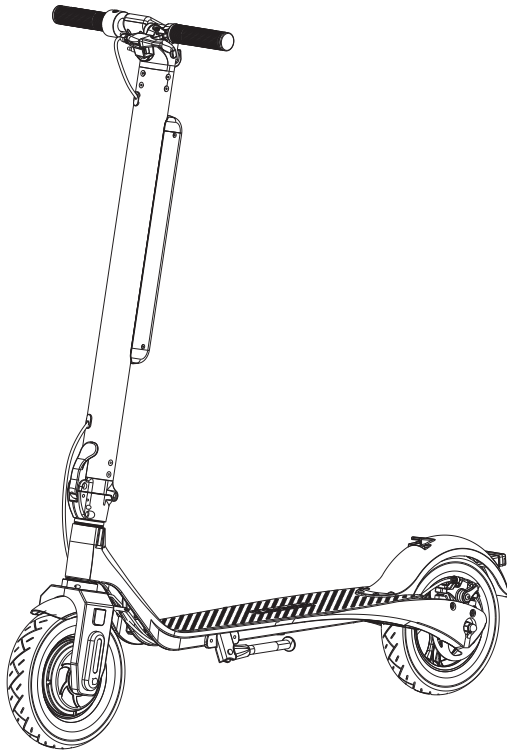

User Manual

Thank you for purchasing this product. To avoid injury to the user and others, be sure to observe the following safety instructions and guidelines. Keep this information for future reference.

## Introduction



Featuring 10" tubed pneumatic tires, this scooter gives you a smooth riding experience. Its powerful 350 watt motor and 36 V battery enable a speed of up to 20 mph with a range of up to 32 miles. The reinforced frame reliably supports a body weight of up to 275 lb.





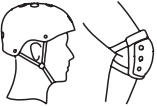

## Important Safety Instructions and Guidelines

### Safety Checks

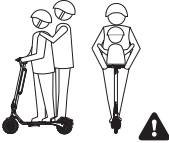
- Ensure the wiring and cables around the handlebar are not twisted, and that the throttle is on the right side while riding the electric scooter.
- Make sure that no parts are damaged or have been modified.
- Make sure that the stem has been secured properly.
- Make sure that Hall cable (black) and brake cable (red) under the brake lever are connected correctly and the brakes operate properly.
- Make sure that the tires are fully inflated.
- Make sure the battery is fully charged (the indicator light turns green).
- Test whether the scooter can be turned on/off.
- Make sure that the front and rear lights function properly in the dark.
- Children under 14 years old should be supervised by an adult.

### Safety Guidelines

	<p><b>WARNING! RISK OF BATTERY EXPLOSION!</b> Do not use the battery if it is damaged or has been modified. Do not expose to heat exceeding 95 °F (35 °C). Only use the original charging adapter.</p>
	<p>Wear protective gear such as a helmet.</p>
	<p>Do not ride the scooter in wet conditions.</p>

	<p>The scooter is only suitable for riding by a single person.</p>
	<p>Do not ride under the influence of drugs or alcohol.</p>
	<p>The maximum load is 275 lb (125 kg).</p>
	<p>Do not use a cell phone or listen to music when riding the e-scooter.</p>
	<p>Check your local traffic regulations whether riding an e-scooter in traffic is legal or not in your area.</p>
	<p>Turn on the lights in the dark.</p>

## Package Contents

- 1 × Folding Electric Scooter
- 1 × Charging Adapter
- 1 × M5 Hexagon Wrench
- 1 × User Manual
- 2 × Keys (including 1 spare key)

## Technical Specifications

Product Information	Unfolded Size	45.3 x 16.5 x 49.2 in (1150 x 420 x 1250 mm)
	Folded Size	45.3 x 16.5 x 20.1 in (1150 x 420 x 510 mm)
	Ground Clearance	5.3 in (135 mm)
	Product Weight	34.2 lb (15.5 kg)
	Adapter Input Voltage	100-240 V AC, 50/60 Hz
Drive System	Motor	36 V, 350 W
	Tire (Front & Rear)	10-inch, tubed pneumatic tires
	Max Speed	20 mph (32 km/h)
	Range	20-32 miles (32-51 km)
	Max Climbing Capability	15%
	Load	44-275 lb (20-125 kg)
Functions	Foldable Stem	Yes
	Battery Pack	Detachable
	Brake System	Electric brake and rear disk brake
	Speed	3 settings (linear adjustment)
	Illumination	LED headlight + taillight (1 W)
	Warning Function	Bell
	IP Rating	IPX4
Operating Conditions	Operating Temperature	32 to 113 °F (0 to 45 °C)
	Storage Temperature	-4 to 104 °F (-20 to 40 °C)
Charger	Input	100-240 V AC, 50/60 Hz
	Output	42.3 V ± 0.3 V DC, 2 A

### Notes

1. Max speed values stated in the user manual depend on the road conditions and the load. Values stated on the rating label are related to average conditions.
2. Mileage is tested under the following conditions: the scooter is driven with the second speed level, 41.8 V full power battery, a load of 165 lb (75 kg), temperature of 77 °F (25 °C), humidity of 70%, gentle breeze, tire pressure of 32 psi (220 kPa) in hot weather and 34.8 psi (240 kPa) in cold seasons. and flat, dry road conditions. Actual results may vary. If the load exceeds 275 lb (125 kg), the mileage and speed may be decreased, which can affect the riding experience.

3. Please ride safely within the maximum speed limit set by local traffic officials. Everyone should strictly abide by all traffic rules and regulations.

## Battery Specifications

Type	Li-ion
Charging Time	Approx. 6 hours
Voltage	36 V
Capacity	10 Ah, 360 Wh
Operating Temperature	32 to 113 °F (0 to 45 °C)
Charging Temperature	32 to 113 °F (0 to 45 °C)
Max Charging Voltage/Current	42 V, 2 A
Storage Temperature	-4 to 104 °F (-20 to 40 °C)
Storage Time	3 months (after a full charge)

## Product Overview

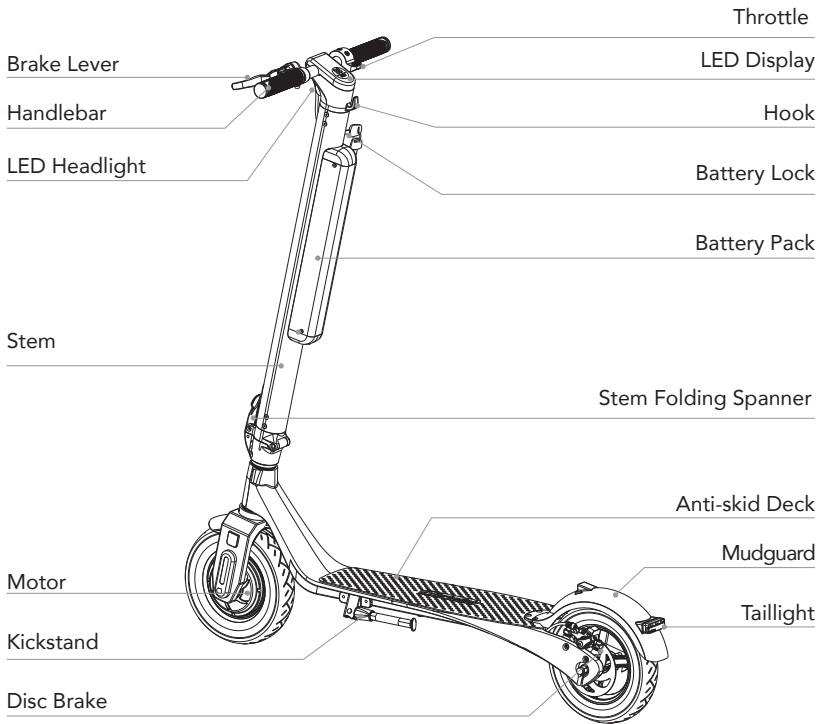

## Controls Overview

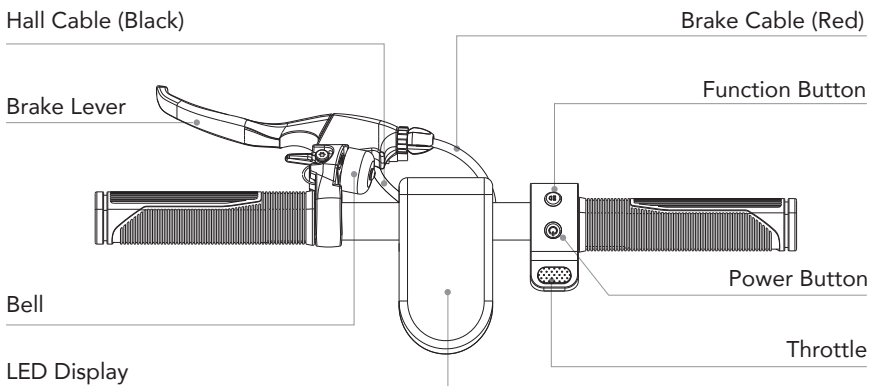

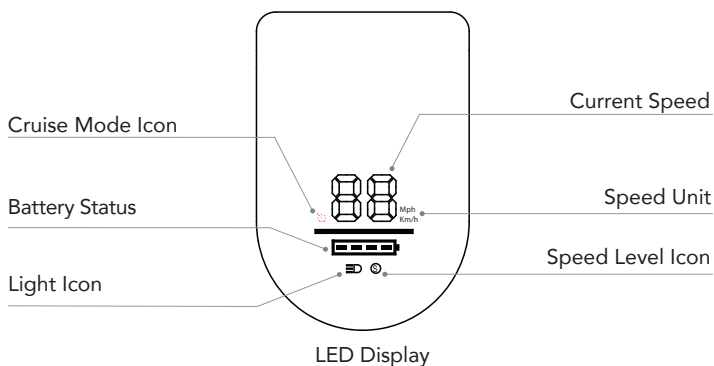

**Note:** If there is no operation within 10 minutes, the scooter will automatically turn off with a "beep" sound.

## Controls Description

Control	Operation	
Power On/Off	Press and hold on the power button for 1 second or longer to turn on/off the scooter.	
Throttle	Press down the throttle to accelerate.	
Brake	Squeeze the brake lever to stop the scooter. When the brake lever is fully depressed, the scooter will come to a complete stop. After that, it will have to be manually started (see the General Troubleshooting and Solution Guide section).	
Speed Mode	Short press the function button twice to adjust the speed mode.	Eco Mode: scooter speed up to 6 mph, "S" icon in white
		Comfort Mode: scooter speed up to 9 mph, "S" icon in orange
		Sport Mode: scooter speed up to 20 mph, "S" icon in red
Headlight	Short press the function button to turn the headlight and taillight on/off.	
Cruise Mode	Maintain a constant speed that you desire (must be at least 3.7 mph or 6 km/h to activate cruise mode). Then, hold the throttle in the same position for six seconds to enable cruise control. Exit cruise mode by using either the throttle or brake lever.	



# Operating Instructions

## Assembly

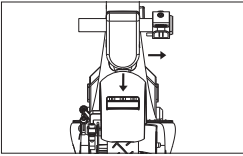
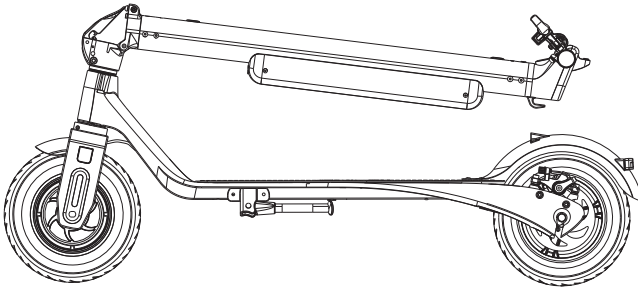

1. Press down the mudguard and slide the stem out of the mudguard hook.



2. Lift the stem up completely and then lift up the stem folding spanner to secure the stem.

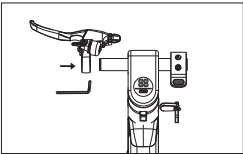

3. Install the brake lever in place on the left side of the LED display with the provided tool.

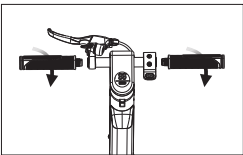

4. Install both handlebars by turning inwards.

## Stem Folding

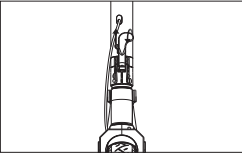
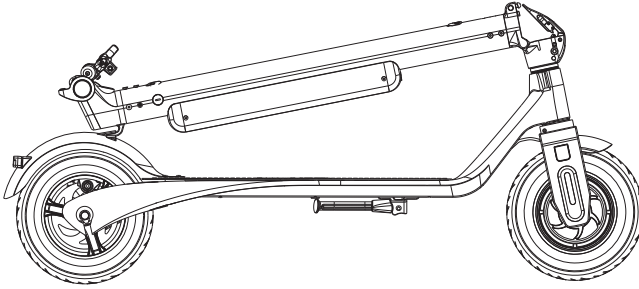

1. Pull up the safety lock while pressing down the folding spanner.

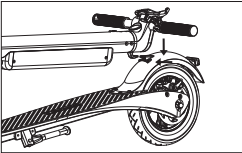

2. Lower down the stem, press down the mudguard, and slide the stem into the mudguard lock.

## Battery Removal

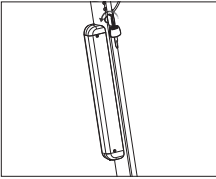

1. Insert the key into the key hole on the right side of the stem and rotate the key anti-clockwise.

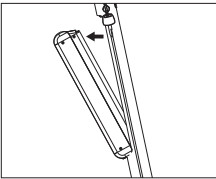

2. Hold the upper part of the battery pack and pull it out while holding the key in the anti-clockwise position.

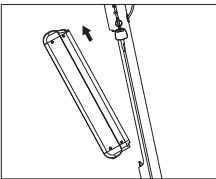

3. Lift up the battery pack and remove it off the stem.

## Battery Installation

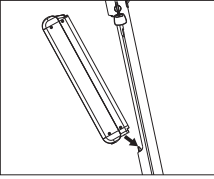

1. Align the groove at the bottom of the battery pack with the raised part on the stem.

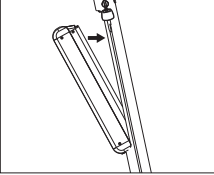

2. Push the upper part of the battery pack into the stem until you hear a "click" sound. Then pull out the key.

## Battery Maintenance

1. Only use the original battery pack. Misuse of other models or brands can cause safety issues.
2. Only use the original power adapter to avoid potential damage, electric shock, or fire.
3. Mishandling of used batteries can cause tremendous harm to the environment. To protect the natural environment, please follow local regulations to properly dispose of used batteries.
4. Do not place the battery in an environment where the ambient temperature is higher than 104 °F (40 °C) or lower than -4 °F (-20 °C) (e.g., do not leave the scooter or the battery pack in a car under direct sunlight for an extended time).
5. Do not leave the battery pack near a heat source, such as a stove, and do not throw the battery pack into fire. Doing so may result in overheating, explosion, or fire.
6. After every use, fully charge the battery to prolong its lifespan.
7. If the scooter is expected to be left unused for more than 30 days, please fully charge the battery and place it in a dry and cool place. Keep in mind to recharge the battery every 30 days to protect it from potential damage, which is beyond the coverage of our limited warranty. Always charge before exhausting the battery to prolong the battery's lifespan.
8. The battery pack performs better within the normal temperature range of 32 to 113 °F (0 to 45 °C), and performs worse when below 32 °F (0 °C). For instance, when the temperature is below -4 °F (-20 °C), the actual mileage will only be half or less than listed. When the temperature rises, the mileage will restore. Note: A fully charged TurboAnt Electric Scooter will last for 120-180 days.
9. The built-in intelligent chip will keep a log of its charging and discharging records. The damage caused by prolonged periods without charging is irreversible and is beyond the coverage of our limited warranty. Once the damage is done, the battery cannot be recharged.

## Riding the Scooter

1. Wear protective gear such as a helmet.
2. Press and hold on the power button for 1 second or longer to turn on the scooter.
3. Place one foot on the middle of the deck and use the other foot to build up some momentum.
4. Gently press down the throttle to accelerate.
5. Squeeze the brake lever to brake.

# Battery Charging

## Charging the Installed Battery

1. Remove the charging port cover at the bottom of the stem. Make sure the charging port is dry and free of dust.
2. Connect the charging adapter.
3. The battery is fully charged when the indicator light of the charging adapter turns from red to green.
4. Close the charging port cover after charging the battery.

\*The scooter cannot be turned on if it is connected to the charging cable, even if the cable is unpowered. When turning on the scooter, please completely remove the cable.

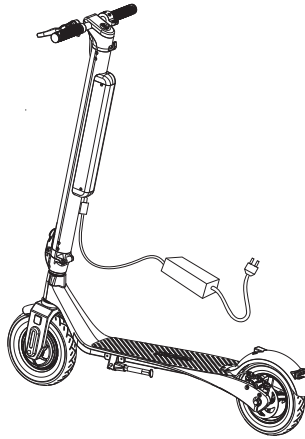

## Charging the Removed Battery

1. Remove the battery (→Battery Removal).
2. Open the charging port cover at the bottom of the battery. Make sure the charging port is dry and free of dust.
3. Connect the charging adapter.
4. The battery is fully charged when the indicator light of the charging adapter turns from red to green.
5. Close the charging port cover after charging the battery.

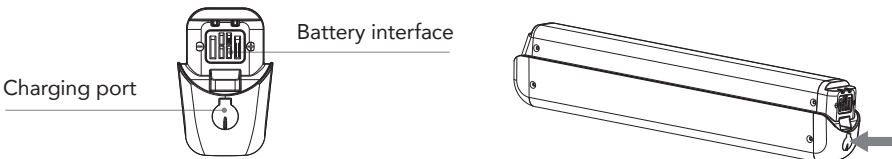

**⚠** Only use the original charging adapter to charge the scooter.

## Maintenance

1. Make sure the scooter is turned off and the power adapter is disconnected.
2. Wipe clean the scooter with a damp cloth. Never use lubricating oil on the body and do not immerse it in water.

## Storage

1. Fully charge the scooter before storing, and charge it at least once a month to prevent premature decay of the battery capacity.
2. Do not charge the battery if the temperature is below 32 °F (0 °C).
3. Keep the scooter in a dry, ventilated, and cool area away from direct sunlight, rain, and high humidity, and cover the scooter to protect it from dust.
4. The kickstand is designed to provide structural support, so avoid standing on the scooter while the kickstand is down, as this can cause the kickstand to crack or break.

## General Troubleshooting and Solution Guide

Problem	Cause	Solution
The scooter will not turn on.	The battery has run out.	Recharge the battery.
The battery will not charge.	The charging adapter is not connected to an AC power source, or the charging adapter is damaged.	<ol style="list-style-type: none"><li>1. Connect the adapter to an AC power source. If the indicator light turns on, the adapter is in good working condition. Then, connect the adapter to the charging port on the stem or the battery (the battery can be detached for flexible charging).</li><li>2. If the indicator light does not turn on, the adapter has broken down. Replace the adapter.</li></ol>
	The charging adapter is not properly connected to the charging port on the stem or the battery.	Check whether the connector of the charging cable is fully inserted into the charging port on the stem or battery. If it is not fully connected, please unplug the cable and re-connect the cable to the charging port.

	The battery power is full or the battery has failed.	<p>After confirming that the charging adapter is functioning, connect the charging adapter to the AC power source and the charging port on the stem.</p> <ol style="list-style-type: none"> <li>1. If the indicator light turns red, then charging is normal and the battery is in good working condition.</li> <li>2. If the indicator light turns green, then the battery is full or has reached its end of life. In case of failure, replace the battery.</li> </ol>
Cruise control cannot be activated.	The current speed is below the minimum speed required for cruise control.	Cruise control can only be activated when travelling at speeds greater than 3.7 mph (6 km/h). Increase speed to enable cruise control.
	A constant speed is not maintained.	Keep a constant speed. Then, hold the throttle in the same position for 6 seconds to enable cruise control.
The stem is loose.	The screws on the stem folding spanner are loose.	Tighten the screws on the stem folding spanner.
The scooter cannot accelerate.	The scooter is set at "non-zero" start and has not been manually started.	Use your foot to give the scooter an initial momentum. When the scooter's speed reaches 1.9 mph (3 km/h), the scooter can be accelerated.
	The throttle is not released.	The throttle is equipped with an electric lock, so it needs to be completely pressed down in order to accelerate the scooter.
The scooter can only accelerate to 6 mph.	The scooter is in the Eco Mode and the speed limit of this mode is 6 mph.	Short press the function button twice to switch to the Comfort Mode or Sport Mode to get a higher speed.
<p>Normal tire pressure is between 30-32 psi (207-220 kPa) in hot weather and 34-36 psi (234-248 kPa) in cold seasons. It is necessary to periodically check the scooter to make sure all parts are in good condition, including the throttle, remaining power, tire pressure, and more.</p>		
The tire has an air leak.	The tubed pneumatic tires may have an air leak if they have been stored for a long period. This is normal, as most air tires require pumping periodically.	Pump up the tires by taking the scooter to an automobile or motorbike repair center, or any location with a proper air compressor. Standard bicycle pumps can also be used to pump up the scooter tires.



## Frequently Asked Questions (FAQs)

### 1. What is the optimum tire pressure when riding this scooter?

The recommended tire pressure is between 30-32 psi (207-220 kPa) in hot weather and 34-36 psi (234-248 kPa) in cold seasons. Please pump up the tires to this pressure.

### 2. The headlight cannot be turned on. How can I solve this problem?

If the headlight won't turn on, please verify that the scooter is turned on. When the scooter is turned on, short press the function button to see whether the headlight functions. Also, check to ensure that the lamp holder is not clogged with dust. If the lamp holder is not clogged with dust, and the headlight still will not turn on, it may need to be replaced. Please contact our customer support center for help.

### 3. What should I do if the scooter's stem is swaying while riding the scooter?

Immediately stop riding the scooter. Verify that the screws that connect to the folding spanner and other screws on the stem are well tightened. If not, tighten the screws using the hexagonal wrench. Periodically tightening the screws on the scooter may be necessary.

### 4. What should I do if the brakes are not functioning properly?

a. Turn on the scooter. Don't stand on the deck. Tilt the scooter to lift the front wheel and manually rotate the wheel. Then, press down the throttle to accelerate, and the front wheel should start to rotate. Next, hold the brake lever. If the front wheel stops rotating, the EBS (Electronic Braking System) is functioning properly. If the front wheel does not stop rotating, the Electronic Braking System may be faulty. Please contact our customer support center for help.  
b. Turn off the scooter, tilt the scooter, and manually rotate the rear wheel. Then, hold the brake lever. If the rear wheel stops rotating and there is no grinding noise, the disc brake is functioning properly. If there is a grinding noise on the brake, the disc brake may be faulty. Please contact our customer support center for help.

### 5. Can I replace the tires on my own if I have a flat tire?

If you have a flat tire, please contact our customer support center for help and repair. It is not easy to replace on your own, and faulty installation may damage other parts of the scooter, which can nullify our limited warranty. Seek help via our customer support center or take the scooter to an automobile or motorbike repair center and ask the professionals for assistance.

### 6. Why does the battery life decrease over time?

The lithium-ion battery capacity will naturally degrade after 500 charge/discharge cycles. The battery performs better when within the normal temperature range of 32 to 95 °F (0 to 35 °C) and performs worse when below 32 °F (0 °C). For instance, when the temperature is below -4 °F (-20 °C), the actual mileage will only be half or less than listed.

### 7. Why has my motor suddenly stopped working?

The reason may be that the controller has malfunctioned, and needs to be replaced. Please contact our customer support center for help and repair.

### 8. When I press down the throttle, why doesn't the motor function properly?

It could be that there is a Hall wire malfunction with the Electronic Braking System. Please check to see if the wire terminals of the brake lever and the panel are loose, and whether the brake lever has been damaged.

### 9. Why can't my mileage reach 32 miles?

The max listed mileage is 32 miles, which is measured under the following conditions: the scooter is ridden with the second speed level, 41.8 V full power battery, a load of 165 lb (75 kg), temperature of 77 °F (25 °C), humidity of 70%, gentle wind, tire pressure of 34.8 psi (240 kPa), and flat, dry road conditions. Actual mileage may depend on a variety of factors including battery status, tire pressure, load, temperature, wind speed, road conditions, riding habits, and more. Please note that the tire is a type of tubed pneumatic tire, so fully inflating the tires can help extend your mileage.

## Environmental Protection

Waste electrical products should not be disposed of with household waste. Please recycle where facilities exist. Check with your local authority or retailer for recycling advice.





深圳市德瓴科技有限公司

料号	BBTA001ABGL		
品名	TurboAnt_X7 Max滑板车 说明书		
材质	120g铜版纸		
工艺	单黑+骑马订+封面过哑膜		
尺寸	148*210 mm		
公差	±1 mm		

注：此页不印刷