

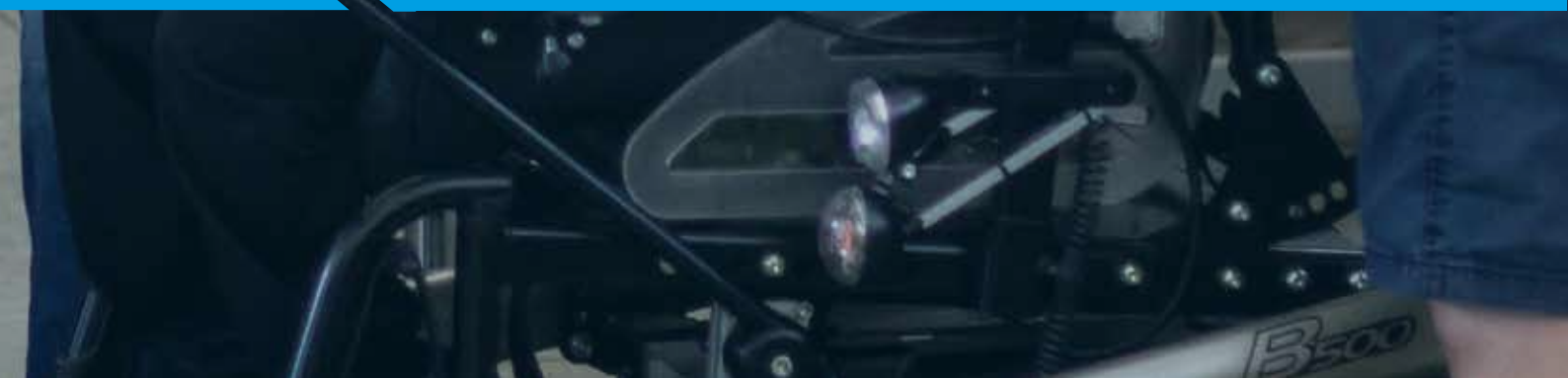

# Products

2019





## Rehadapt Engineering GmbH & Co. KG

📖 Heinrich-Hertz-Str. 104  
34123 Kassel, Germany

☎ Tel.: +49 561 220 717 0  
📠 Fax: +49 561 220 717 99

✉ officeteam@rehadapt.com

## Rehadapt North America

📖 7619 A1A South  
St. Augustine, FL 32080

☎ Tel.: +1 904.687.0130  
📠 Fax: +1 904.342.6278

✉ officeteam.na@rehadapt.com

## Visit us!



/user/rehadapt



/rehadaptengineering



/company/rehadapt-engineering



/rehadapt



/rehadaptengineering



/rehadaptengineering



www.rehadapt.com

## The Rehadapt team

Many hands and brains are needed to create our solutions. Our team consists of many individuals from different backgrounds who each bring a unique treasure of experiences, a broad variety of skills, their very own creativity and their personal mindset. And we all share one passion: to help people reduce social barriers.





## Simple, intuitive and reliable!

That's what mounting solutions should be like. Our customers's daily challenges are complex enough. This is a well known fact to clients, carers and technology providers. That's why we do everything we can to build solutions that make life simpler for all parties involved. Enhancing and expanding our modular system of mounting components leads to clever mounting solutions for each stage of a day.

In everyday life with different caregivers in varying situations these mounts need to work reliably - and they do!

This is achieved through our unique service concept, more than a decade of experience in product design, a versatile system of components, high quality standards in manufacturing and a holistic view on each and every individual challenge!

So it is our pleasure to present this new catalog. We worked hard to improve our products and to invent new ones to bring back as much quality of life as possible to our customers.

*Your Rehadapt team!*



# Catalog content



## Unimpeded communication

Let our users tell their stories on pages 6, 20, 32 and 41

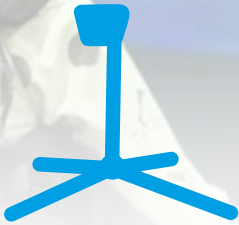
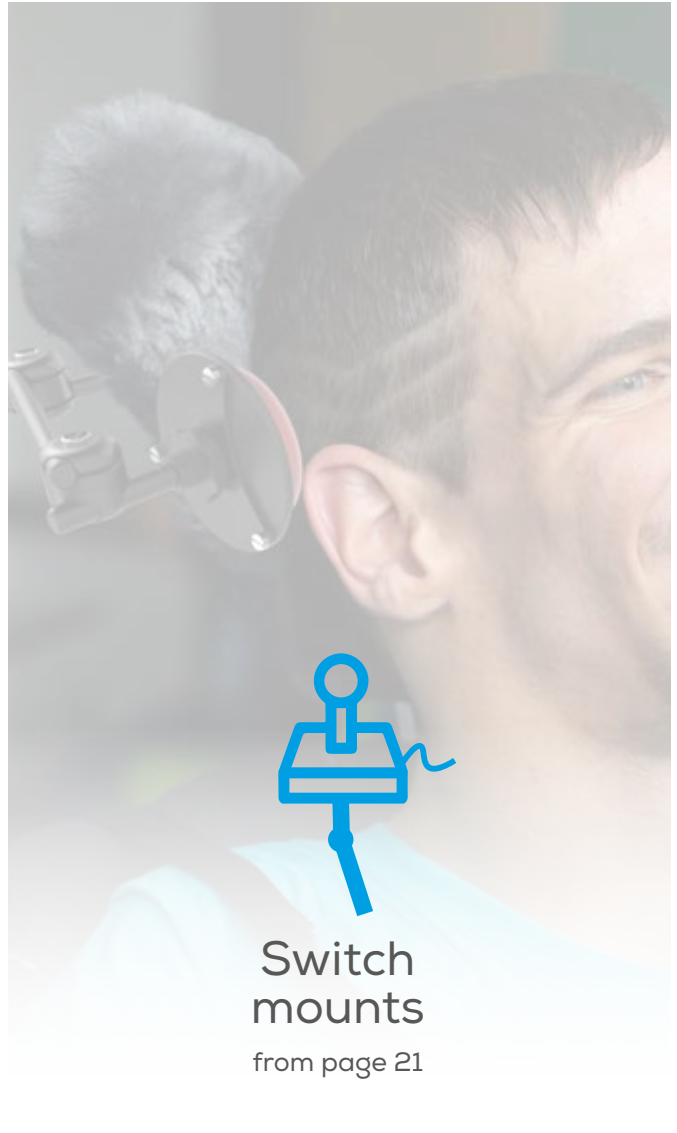

Table  
mounts

from page 17



Switch  
mounts

from page 21

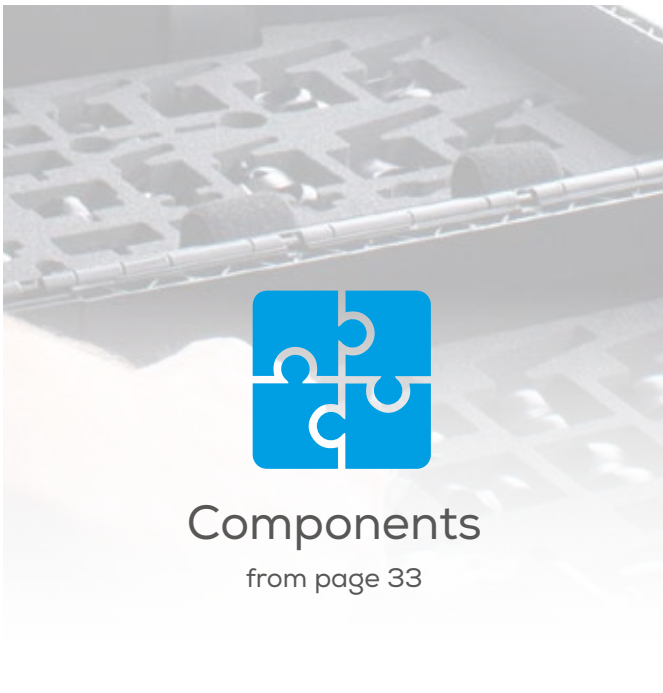

Components

from page 33

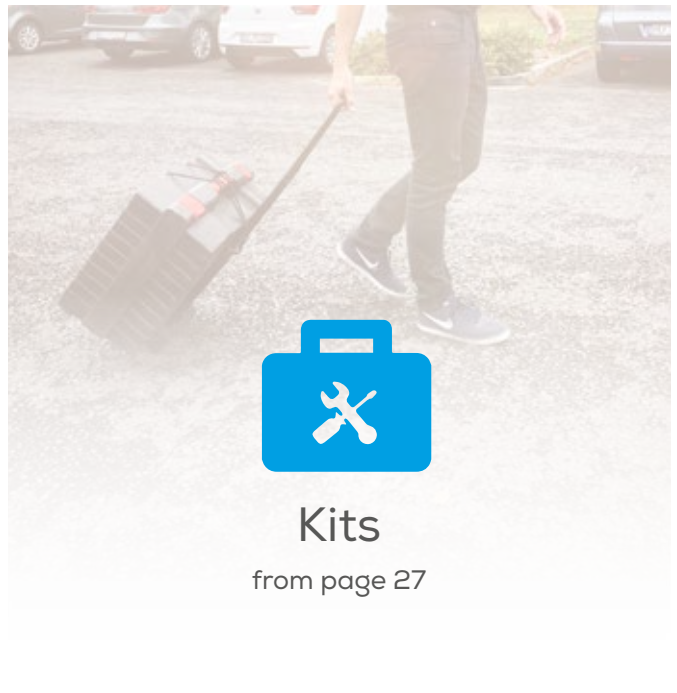

Kits

from page 27

## Solutions for specific situations

from page 25

# Unimpeded communication

Rehadapt tries to support dedicated programs to help individuals with special communication needs as often as possible.

In the course of celebrating Saltillo Corporation's jubilee – a manufacturer of communication devices in the AAC field for 20 years now – Rehadapt was honored to present an individual mounting solution for the jubilee winner Alex new communication device – customized and perfectly adapted through our unique Virtual Mounting Solution (VMS) service.

„At school we are excited to use the mount because no matter which classroom he is in the NovaChat can be in the right position for his visual and accessibility needs. It fits close to the chair so he can move around tight classrooms and he can even pull his chair up to the classroom tables.“

*Jesus Alejandro Reyes Sanchez (Alex)  
with his teacher Lisa Peterson*

Alex



Sara

Sara Holjević is 8 years old, lives in Karlovac and has cerebral palsy. She can not walk or talk but communicate. Using a speech generating device mounted by Rehadapt Sara greatly improves communication with the environment, can clearly express her feelings, needs and desires, to learn, to answer questions and play games. This fall she is moving into the first grade of school and we believe that our mounting solution is a great help in learning and mastering the program, and the successful establishment of communication in the new environment

*Sara Holjević with her parents*

# WHEELCHAIR MOUNTS

There is a plethora of wheelchairs being used, with many significant differences. We get your device securely mounted on any of them! A huge range of base clamps ensure solid fixation to any manual or powered wheelchair: clamping onto the frame, on the arm- or footrest, or underneath the seat. Our system is easy to use and quick to adjust even without tools.



## M3D

## L3D

Three-tube solutions for most common situations

Double tubes for more rigidity at higher load

Short mounting length ideal for children's wheelchairs

Folding mount for easy exiting and parking

For extra offset without using additional joints

One- to three-tube-solutions for lightweight devices

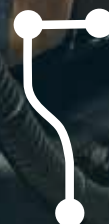

Standard

Eye Control

Short

Fold down

Curved

Standard

# Monty 3D

Monty 3D - the quasi-standard of all mounts - is the popular choice for most wheelchair solutions. It consists of aircraft-grade aluminum tubes with outstanding mechanical properties that are perfectly round. That precision translates into maximum clamping force. Rehadapt's signature tube joints allow for full 360° adjustment in all dimensions - equipped with Allen key screws or QuickShift levers.

For the user's transition in and out of the wheelchair, the mount can easily be swiveled into three positions: operation, transfer and parking. Our universal device socket (UDS) includes our quick release system which allows for the safe device attachment within seconds. With a small footprint on the device, yet great sturdiness!

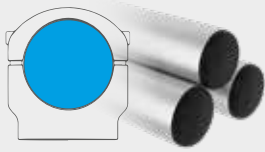

highest precision for maximum clamping force

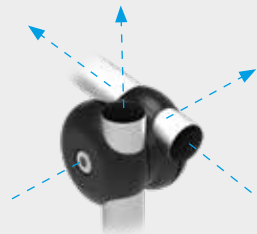

full 360° adjustments in all directions



quick release dovetail socket with small footprint

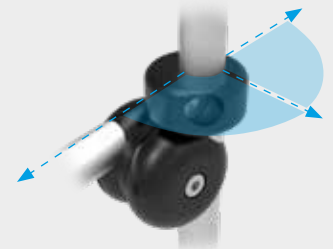

easy swiveling into different positions

# Standard

Standard mount composed of three tubes with multiple options. Suitable for devices up to 3,2 kg (7 lbs).



**"Monty-3D"**  
Wheelchair mount with universal device socket (UDS) for communication devices and notebooks. Fully 3D-adjustable joints. 3 pre-defined positions: operating, transfer and parking. A quick removal of the mount from the wheelchair is possible by easily pulling upwards, no unlocking required (may be user operable).

11.1016

without UDS:

11.1000

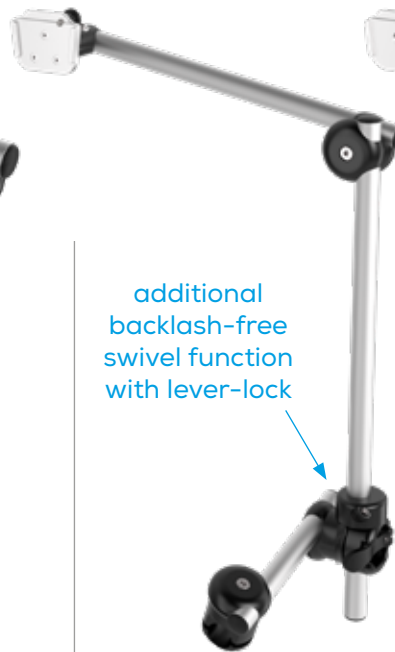

additional backlash-free swivel function with lever-lock

**"Monty-3D S"**  
With indexing slot and lever-locked.

11.2016

without UDS:

11.2000



additional QuickShift lever

**"Monty-3D QS"**  
With additional QuickShift levers.

11.2516

without UDS:

11.2500





# EyeControl

EyeControl mounts include longer tubes to allow for the positioning of your communication aid precisely where you need it. Available in two versions for devices lighter or heavier than 3,2 kg (7 lbs).



"Monty-3D EyeControl"  
Includes a UDS with two levers for separated fixation of the ball joint and the tube. This way the weight of the device remains supported during repositioning. That makes it easier to adjust heavy devices.

11.2616



"Monty-3D EyeControl HD"  
Heavy-duty wheelchair mount for devices over 3,2 kg (7lbs). This mount has a double-tube foundation with an anti-sagging protection, as well as a backlash-free swivel unit.

11.2916

Suitable accessory:  
"Easy-Off Kit" (s. page 47)

## "HD"

The additional tube works as a supporting strut for more rigidity with higher loads. Perfect solution designed for eye tracking and other devices heavier than 3.2 kg (7 lbs).



# Fold down

Fold-down wheelchair mount, backlash-free. Exiting/parking of device is possible by folding upwards and then to the side.



"Monty-3D K L"  
For left side mounting. Specify frame clamp upon order.

11.3116



"Monty-3D K R"  
For right side mounting. Specify frame clamp upon order.

11.3016 no UDS: 11.3000

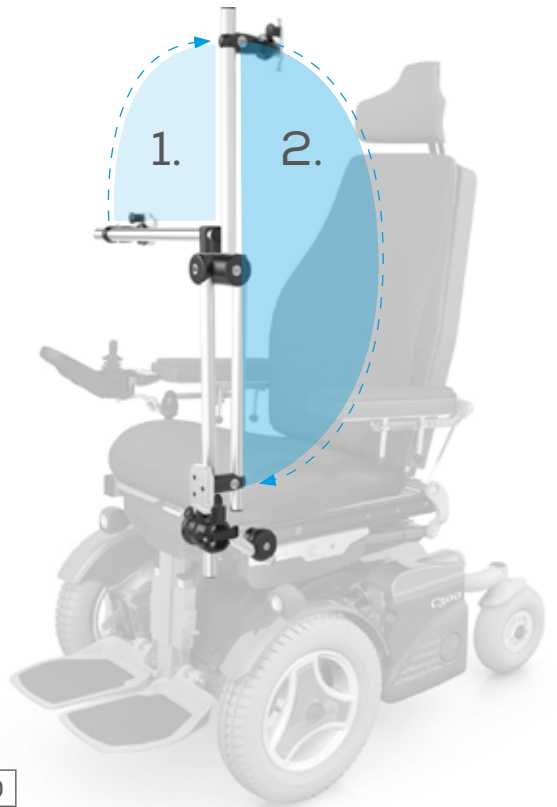

# Short

Small yet very sturdy two-tube wheelchair mounts. Suitable when a short mount is sufficient. Ideal for sports or kid's wheelchairs and very practical for transport as the complete mount can be easily removed from the chair, with only the frame clamp remaining. Backlash-free swivel function between operating, exiting and parking position.



"Monty 2R S"  
with indexing latch

11.4000



"Monty 2R QS"  
with indexing slot and QuickShift lever

11.4500



"Monty 2R DC"  
with dual clamp

11.4600

# Curved

Curved tubes in three sizes to get extra offset from the mount attachment point without additional joints. Recommended when the need for an offset is rigidly defined (e.g. when using a traytable or when device position has to be far from the body as with some eyetrackers). Optional QuickShift joints and double-lamp device sockets.

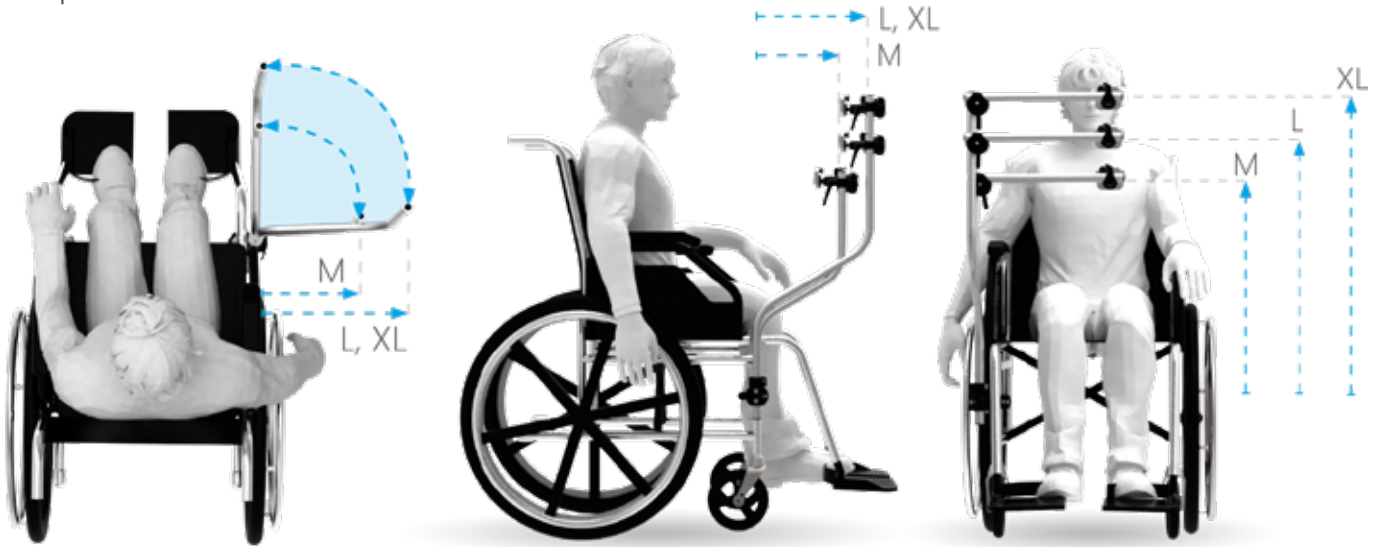

"Monty-3D Curved M"  
228 mm x 660 mm (9" x 26")

11.4700

"Monty-3D Curved M QS"  
with additional QuickShift lever  
and indexing slot

11.4701



"Monty-3D Curved L"  
304 mm x 762 mm (12" x 30")

11.4710

"Monty-3D Curved L QS"  
with additional  
QuickShift lever

11.4711



"Monty-3D Curved XL"  
304 mm x 863 mm (12" x 34")

11.4720

"Monty-3D Curved XL QS"  
with additional  
QuickShift lever

11.4721

# Light 3D

The L3D line offers a lean and sleek design while still providing the core values of Rehadapt mounts, i.e. unlimited 3D adjustability and ultra strong aluminium tubes.

By default Light 3D mounts economically end with a joint to chuck a pin from the device cradle („SLS” for “Spigot Link System”). The quick release socket can

also be used for more comfort („UDS” for “Universal Device Socket”).

You can combine holders for all devices that weigh under 1.35 kg (3 lbs): iPads, tablets or smartphones, dedicated communication aids or accessibility tools like switches, joysticks or mice. You name it - we hold it!

## Three clamps to choose from...

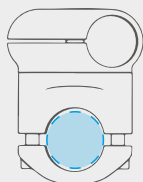

### Base clamp

Our baseclamps are unmatched in their clamping force, as they are custom-fitted and permanently attached to a specific wheelchair part.

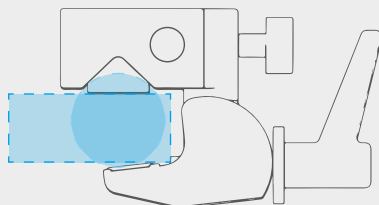

### SuperClamp

Great versatility: it clamps both on boards and tubes so it fits tables, armrests, bed rails or countless other things. We improved the original design to have a powerful link to the rest of the mount.

for quick, temporary and variable attachments



### MiniClamp

As quick to attach and detach, but much more compact is our new MiniClamp. It works well for round or oval tubes of typical wheelchair frame diameters. That makes it ideal for switches!

## Two attachment systems to choose from...



### SLS

a joint in which you insert the pin from the device cradle



### UDS

Rehadapt’s comfortable quick release system



L3D wheelchair mounts are composed of one, two or three tubes and are either equipped with either a joint with Allen key screw (AK) or a QuickShift joint with lever (QS). All of the mounts are equipped with our base clamp. All 3-tube mounts have a swivel-joint to easily swing the mount from operating into transfer or parking position.

	SLS		UDS	
	Allen screw	QuickShift	Allen screw	QuickShift
1 tube	L3D-WC 1AK 14.3001	L3D-WC 1QS 14.3051	L3D-WC 1AK-U 14.3101	L3D-WC 1QS-U 14.3151
2 tubes	L3D-WC 2AK 14.3002	L3D-WC 2QS 14.3052	L3D-WC 2AK-U 14.3102	L3D-WC 2QS-U 14.3152
3 tubes	L3D-WC 3AK 14.3003	L3D-WC 3QS 14.3053	L3D-WC 3AK-U 14.3103	L3D-WC 3QS-U 14.3153

# FLOOR STANDS

Our floorstands provide a great mount even if there is nothing to mount to. Lying in a nursery bed, sitting on a recliner or even on a bean bag? We will still hold your device in an ergonomic and stable position!



## Classic

Versatile and strong with many options to choose from.

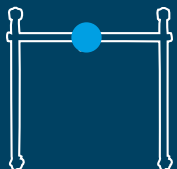

## Pentalock

Smaller footprint through rolling star base.



## Mini

Smallest footprint. Ideal for lightweight devices.



# Floorstand Classic



## “Eco”

**Plain and economic** - The Eco floorstands offer basic functionality at affordable prices. Both the column and the base are fixed but the flexible arm allows a precise positioning.

## “Tele”

**Height adjustable** - The Tele floorstands allow for mounting devices in elevated positions (e.g. for usage in hospital beds). The column includes a gas-spring to help you move the device upwards and can be extended up to 70 cm (27”).

“EcoLock”

17.1055

“TeleLock”

17.1050

“TeleLock QP”

17.1052

with QuickPack option

“EcoFloat”

17.1055

“TeleFloat”

17.1050

“TeleFloat QP”

17.1052

with QuickPack option

## Adjust with your fingertips

After the initial adjustment, the FloatArm keeps the device weight in balance at any position. Simply pull or push the device to the desired spot – no control lever or screw needed.



## Casters

The wheels roll on both hard floors and carpets. They can also be locked in place.



## Accessories



### "FS Laptop Tray"

Multi-purpose tray to hold laptops, papers, books etc. Is attached to the floorstand column. Size: 43 cm x 32 cm / 17" x 12.5".

17.2001

### "Transport bag for FS QuickPack"

Rolling transportation bag for the floorstand QuickPack models. Made from sturdy ballistic nylon. Features heavy-duty handles and zippers.

02.0003



Height adjustable through gas-spring-supported telescopic column

Base with variable width

## "Vario"

**Width and height adjustable** - Besides adjustability in height, the Vario floorstands offer a base with a variable width. This allows passing through narrow doors. Furthermore, the column can be centered or placed on a side.

Our classic floorstands are available in many variants. This way you will find the perfect solution for any specific situation.

Chose the type of the **base**  
Chose the type of the **arm**

### "VarioLock"

17.1061

### "VarioLock QP"

17.1063

with QuickPack option

### "VarioFloat"

17.1061

### "VarioFloat QP"

17.1063

with QuickPack option

## "Lock"

with Monty 3D arm  
with QuickShift levers.

## "Float"

with free floating articulated arm.

## QuickPack option

The optional QuickPack feature allows you to fold down the stands in no time. The handy transportation bag included allows you to conveniently travel with the equipment for usage in different locations.

**You will be amazed how lightweight a Rehadapt floorstand is - given the size and sturdiness of the products: 9 kg (20 lbs)!**



# Floorstand Pentalock



"FS-Pentalock Tele"  
on a gas-spring loaded column.

17.1100

without counterweight:

17.1101\*

"FS-Pentalock Eco"  
on a non-telescopic column optimized for nursing beds.

17.1100

without counterweight:

17.1103\*

Telescopic floorstand on five-star base with casters to position communication aids over beds, sofas or wheelchairs with a small footprint. Includes a "Lock" articulated arm with a double-clamp and QuickShift joints.



\*Pentalock floorstands always require a counterweight for safe operations! Variants without included weights are meant to save shipping costs and come with instructions how to add a locally obtained weight.

# Floorstand Mini



"FS-L3D"  
Elegant floorstand ideal for lightweight devices (max 1 kg / 2,2 lbs). Features a gooseneck for easy adjustments. UDS included.

17.1400

"FS-L3D-HD"  
Elegant floorstand ideal for lightweight devices (max 1,5 kg / 3,3 lbs). Features L3D tubes and QuickShift levers. UDS included.

17.1410



Can roll over two wheels when being tilted.



Very flat base: only 11 mm / 35 mm height!

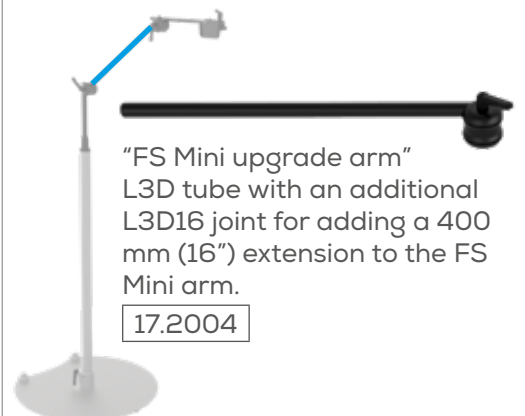

"FS Mini upgrade arm"  
L3D tube with an additional L3D16 joint for adding a 400 mm (16") extension to the FS Mini arm.

17.2004



# TABLE MOUNTS

Our tablemount product range ensures very sturdy mounting for all types of devices. Whether you want to place the device on top of something - even on uneven surfaces - or whether you want to clamp it onto a piece of furniture, Rehadapt has the right solution for you!

---

## Tablestands

Self-standing tablemounts that hold devices on a tripod, in a kickstand or on an x-frame which automatically brings the mount into an upright position on uneven surfaces.

## Tableclamps

Tableclamps are securely clamped onto a given table or armrest. This saves space on the surface. Optionally they can be mounted on walls.



# Tablestands



## "TS-FT"

Folding tablestand for tablets. The hard hinged joint allows a multitude of angles. Holds tablets with and without protective case (width: 10 mm and 25 mm).

12.1660

Folds open and wraps around 9,7" tablets for easier transportation.

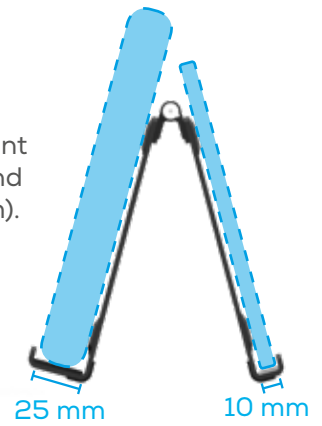

## "TS-GO"

Easily foldable tablestand that ensures the secure positioning of devices. Ideal for transitions between different sites. Each TS Go comes with a transportation bag that fits perfectly.

12.1652



## "TS-GO Bag"

The TS-GO Bag fits the folded TS-GO perfectly to ensure an even easier and safer transportation.

02.0007



## "TS-XL"

Tabletop mounting system. Universal device socket included (UDS-22-DC). Device height: 5 - 500 mm (3/16" - 19 11/16").

12.1602

X-formed frame with self-leveling mechanism.



## "TS-DC"

Tablestand mount with a straight, vertical tube and universal device socket (UDS-22-DC). Features vibration- and slip-proof rubber feet. Height: 5 - 250 mm (3/16" - 9 13/16").

12.1653



"TS-UC"

Tablestand designed for flat surfaces. It prevents skidding or sliding. Holds the communication device upright, flat or at any tilt angle.

12.1650



Mounting in two directions for steep and flat device positions



Folds flat for easy transportation

## Tableclamps

### OneHand

Keeps devices floating for easy repositioning. Device can be moved 90° vertically and 360° horizontally.

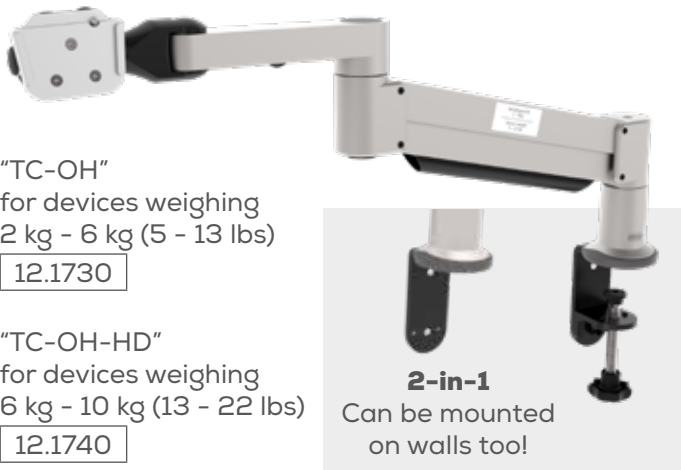

"TC-OH"  
for devices weighing  
2 kg - 6 kg (5 - 13 lbs)

12.1730

"TC-OH-HD"  
for devices weighing  
6 kg - 10 kg (13 - 22 lbs)

12.1740



**2-in-1**  
Can be mounted  
on walls too!

### Fleximounts

Goosenecks for maximum flexibility. Includes an universal device socket (UDS) or a spigot link system (SLS).



"TC-FM"

UDS	12.1721
SLS	12.1722

### M3D

Durable Monty 3D tablemount systems with a Superclamp for heavy weight devices. Includes joints with QuickShift levers and an universal device socket with double clamp (UDS-22-DC).

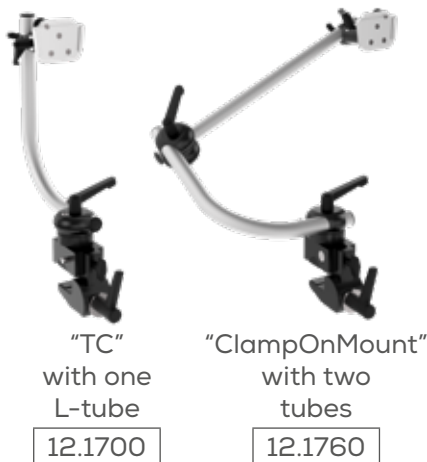

"TC"  
with one  
L-tube

12.1700

"ClampOnMount"  
with two  
tubes

12.1760



"ClampOnMount  
Dual-SC"  
with two  
Superclamps

12.1770

"ClampOnMount  
Dual-CC"  
with two  
C-clamps

12.1771

# L3D

Light 3D tablemounts with one, two or three tubes each equipped with either joints with Allen key screws (AK) or a QuickShift levers (QS).

Available with either the universal device socket (UDS) and spigot link system (SLS). Combine with any SLS/UDS cradle or device adapter. All equipped with the SuperClamp.



	SLS		UDS	
	Allen screw	QuickShift	Allen screw	QuickShift
1 tube	L3D-TC 1AK 14.4001	L3D-TC 1QS 14.4051	L3D-TC 1AK-U 14.4101	L3D-TC 1QS-U 14.4151
2 tubes	L3D-TC 2AK 14.4002	L3D-TC 2QS 14.4052	L3D-TC 2AK-U 14.4102	L3D-TC 2QS-U 14.4152
3 tubes	L3D-TC 3AK 14.4003	L3D-TC 3QS 14.4053	L3D-TC 3AK-U 14.4103	L3D-TC 3QS-U 14.4153

## Anne

Anne Sophie is happy with her Light 3D mount from Rehadapt. She told us it's not just practical but it's the only mount which is also looking cool.



Anne Sophie happy with her new L3D mount from Rehadapt

# SWITCH & CONTROL MOUNTS

Our switch and control mounts are made of L3D components and therefore ideally small and lightweight to carry any imaginable switch. Especially control mounts (e.g. Omni Control or Meyra attachments) near headrests are a challenge to mount because wheelchairs often do not offer good mounting positions in this area. But with Rehadapt's sleek and sturdy L3D system there is always a way!

---



# Switch mount bundles

Light 3D table mount that uses our multipurpose SuperClamp. Includes two tubes and two joints with levers for the following switches (adapter included - switch not included). We have adapters for every need! If not listed here, feel free to contact us.



L3D-TC 2QS for the AbleNet Buddy Button or Specs		14.1016
L3D-TC 2QS for the AbleNet BigRed		14.1015
L3D-TC 2QS for the WobbleSwitch		14.1004
L3D-TC 2QS for the Mini-Joystick		14.1011
L3D-TC 2QS for the AbleNet JellyBean		14.1014
L3D-TC 2QS for the Proximity Switch		14.1010
L3D-TC 2QS for the PikoButton		14.1013

# MagicArm

Includes a SuperClamp and an arm articulated with balljoints and a locking knurled knob. The versatile clamp can be attached to both straight and round surfaces (thickness/diameter 13 - 55 mm).

15.1000



# Control mount bundles

## iAdapter



for the iAdapter.  
Includes three tubes, two joints with levers, one swivel unit and a SuperClamp

14.1054

for the iAdapter.  
Includes a wheelchair clamp to be stated upon order.

14.1053

## IntegraMouse

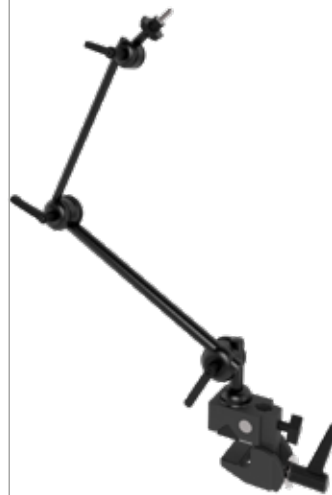

for the Integramouse & Keo.  
Includes two tubes with levers and a SuperClamp

14.1017

## IntegraMouse Plus



for Integramouse Plus.  
Includes joints with lever(s) and a SuperClamp

L3D-TC 1QS (1 tube)	14.1036
L3D-TC 2QS (2 tubes)	14.1035
L3D-TC 3QS (3 tubes)	14.1034

# MiniClamp

As quick to attach & detach, but less bulky than the SuperClamp we present to you our MiniClamp. It is ideal for round or oval tubes of typical wheelchair frame diameters. That makes it perfect for switches!

Small universal tube clamp for 13 to 35mm tubes (½" to 1 ⅜") with rubberized clutches. Quick toolless fixation with a clamping lever. Optimal for lightweight items such as switches.



UNC thread to attach desired button plate.

01.1008



Includes a QuickShift joint to attach SLS switch adapters or L3D10 tubes.

14.1174



Complete switch mount with two L3D10 tubes and two QuickShift joints to combine with any SLS switch adapter plate. Adapter not included.

14.5052

## MiniClamp switch mount bundle

Universal mount kit for quick positioning of switches. Includes our versatile MiniClamp, three QuickShift joints, two 10mm (⅜") diameter tubes totaling 400mm in length.

**This bundle includes the three most popular switch mount adapters (for the Buddy Button, the Specs, the Jelly Bean, the BIGmack etc).**

14.5552



## Control mounts

L3D switch mounts to position controls like switches, joysticks or proximity sensors on wheelchair headrests or similar. State the desired frame clamp upon order (default: 16mm (⅝") round).



for one switch

with Allen screws	14.1000
with QuickShift levers	14.1050



for two switches

with Allen screws	14.2000
with QuickShift levers	14.2050

# Solutions for SPECIFIC SITUATIONS

We offer a wide product lineup of mounting solutions for any situation. Our versatile M3D and L3D systems let us combine a wide range of components to achieve the best possible solution even in contexts.

## Bed mounts

Innovative mounts  
for all kinds of beds.

## Car mounts

Swift adjustment and fixation  
on the headrest poles.

## Wall mounts

Wall mounting plates with sev-  
eral options for the M3D system.





# Bed mounts

Innovative QuickShift mounts held by the weight of the mattress. By its unique and simple attachment method, the bedmount works for all beds. Simply slide it under the mattress and you got it mounted! With universal device socket (UDS) or for the spigot link system (SLS).



"L3D Bed mount UDS"  
with rigid tube & gooseneck

UDS 14.8002



"L3D Bed mount SLS"  
with rigid tube & gooseneck.

SLS 14.8003



"L3D Bed mount SLS HD"  
with rigid tubes

SLS 14.8053

# Car mounts



"L3D Car seat mount"

Light 3D mount for attaching a light-weight device to the rear of a car seat. Fixation on the headrest poles. Swift adjustment of joints through QuickShift levers. L3D UDS included.

14.1070





Parking for  
your mounts!

# Wall mounts

Wall mounting plate with base for mounting Monty 3D tubes.  
Fixation screws and dowels not included.



"M3D Wall mount  
Base Perpendicular"  
for mounting tubes  
perpendicularly to the wall.

11.1051



"M3D Wall mount  
Base Parallel"  
mounting tubes parallel to the wall.  
Tube clamps with a QuickShift lever.

11.1052



"M3D Storage Wall mount"  
This wallmount unit consists of a  
wall mounting plate with base and  
a sturdy M3D tube. The mounting  
bracket allows Monty 3D wheel-  
chair mounts to be removed from  
the wheelchair and packed away  
on the wall when their usage on  
the wheelchair is not needed.

11.5001



"M3D Wall mount"  
Wall mount that includes two tubes (one of them L-shaped), an universal joint  
and an universal device socket (UDS). Includes slipout safeguards on all tubes  
and QuickShift levers on all joints. Must be mounted on stable walls. Fixation  
screws and dowels not included.

11.5000

# KITS, TOOLS & TRAININGS



A vertical promotional banner for Rehadapt. At the top, the 'Rehadapt' logo is displayed in a stylized font. Below the logo is a photograph of a woman sitting in a wheelchair, smiling. The text 'What is a good mount service? without a great service?' is written in white and blue. Below this, a blue banner contains the text 'Let us design a bespoke solution for your specific needs - free of charge!'. At the bottom, the 'i:vms' logo is shown, with the tagline 'what you need is what we do'. The website address 'www.rehadapt.com/vms' is printed at the very bottom.

# Service Kit

We want to make working with our products as simple as possible – however, even after thorough planning, installing a mount could involve a number of issues, from your customer having a new wheelchair, to changing their mind about the position of the device.

In order for you to successfully complete the installation without having to order new parts and wait for the delivery, we have developed a handy bag that contains the most important materials and tools needed for small ad hoc changes, spontaneous maintenance or other unexpected requirements.

With our M3D Service Kit, consultants delivering devices with a M3D wheelchair mount will be prepared for a number of situations, saving time and money, and immediately providing a user-friendly solution to common problems.

The service kit is also useful when you visit a facility with several clients and find older mounts in poor shape. The tools and replacement parts contained in the kit will allow you to perform maintenance and leave your clients with mounts as good as new.

Everything neatly packed in a sturdy and stylish bag that is easy to transport.



- ✓ Maintenance kit
- ✓ Replacement parts
- ✓ Small and light transportation bag



"M3D Service Kit"  
Small lightweight bag for the quick replacement of components of the M3D line. The kit includes tubes, frame clamps, joints and consumables, as well as measuring and adjustment tools.

19.9100

# Assessment Kit

Rich assortment of mounting elements to cover full range of Assistive Technology mounting needs. Allows for assessing positioning needs & practical handling of AAC equipment, but also building custom mounts to fit almost any wheelchair. The kit enables coping with tricky wheelchairs, double tube mounts for enhanced ruggedness, or unusual mount lengths. Includes a number of generic adapters, comes with a folding carry cart.

## „The key to turn technology into Assistive Technology“

Positioning has always been key to turn technology into Assistive Technology. Finding the right spot for devices, displays or access tools is an important part of every evaluation. The needs of assessment teams on that quest were guiding the development of the Rehadapt Assessment Kits.

The results are truly spectacular:

- ✓ Composed of field-tested assortments of items for real life scenarios
- ✓ Held ready in highly durable, mobile, and easy to maintain cases
- ✓ With helpful documentation, supporting beginners & advanced users
- ✓ Heavily subsidized to make these essential tools truly affordable

The Rehadapt Assessment Kit come with individual order codes that allow for life-long discounts when parts of the Kit need to be re-stocked.



- ✓ Comprehensive documentation
- ✓ M3D/L3D parts for general and specialized wheelchair attachments



### “Assessment Kit”

Full kit to assess mounting of any device or switch to wheelchairs, including sophisticated and Heavy duty setups. Selection holds all relevant items of Rehadapt portfolio. Cart included.

19.9013

# Trainings

To position a communication device sounds as challenging to you as climbing the Mount Everest? That is what we want to change!

"How to mount an eyetracker to a powered wheelchair full of special controls and mechanical features?" "What is the best location for a mount to clamp?" "How can I add a second switchmount without wasting space for other wheelchair equipment?"

## Together we will find a way!

While we try to simplify the work of our partners with our VMS service and our new service kit, achieving the perfect mount can still be challenging. The best way to become an expert is through hands-on experience. That is why Rehadapt started organizing regular training events - the Rehadapt Mounting Days.

In these hands-on workshops we elaborate together to find the quickest and most expedient mounting solution. With a wide range of wheelchair types you will learn real-world situations as you find in the field. The course will allow you to broaden your knowledge and adding efficiency, economy and quality in providing mounting solutions.

If you are interested and want to know when the next Rehadapt Mounting Days will start just give us a call!

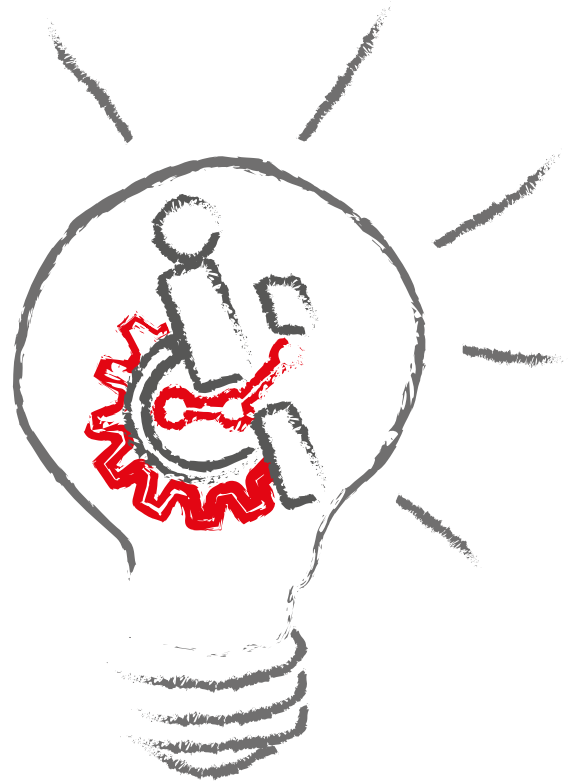

## Rehadapt's Hands-on-Workshops



# Tools



"Service Kit -  
Quick release lever"  
Replacement kit for the swivel joint  
S with a toughened steel lever.

11.1260

In the past, there were certain instances where the fastener of the swivel joint, due to heavy weight broke. Drilling deeper into the enclosure, now allows us to flush mount the lever so that it is shielded from other heavy weights. The former lever, which was produced with a zinc die casting, is now replaced by a steeled lever. In fact, with this new material the risk of breaking the lever when crashing into a doorframe or due to heavy weight, gets minimized.

We hope that by improving our products, helps you and also your customers to find the best solutions. We have made it our priority to make sure that our products will not fail even under extraordinary weight. In connection with that is our goal, to make communication aids usable in all different circumstances.



"Screw kit for UDS DC"  
Replacement kit for the dual clamp levers of the  
UDS 22 DC

16.1051BS

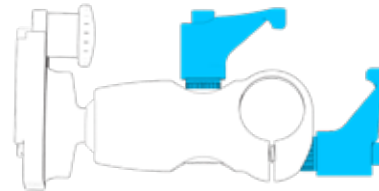

Replacement kit to exchange a lever with an Allen screw. For a fix adjustment of the ball joint or the tube clamp.

# Allen wrench



"T-Handle - Allen wrench  
5mm"  
T-handle Allen wrench  
metric system (5 mm).

01.0027



"Allen wrench 5 mm long"  
Allen wrench 5mm. With  
long shaft.

01.0008



"Allen wrench 5mm"  
Allen wrench 5mm. With  
short shaft.

01.0014

Adam, his family, teachers and therapists are so excited about his new communication device from Tobii Dynavox and the mounting arm from Rehadapt Engineering that will mean he can always have it with him wherever goes. Thank you to the teams at both of these remarkable companies that made this possible.

Inclusive Solutions , South Africa



Adam

Adam with his teachers and therapists



Julia

One of the users of our mounts, 10 year old Julia Nickel, became a celebrity after a video showcasing her and other Assistive Technology users gathered more than 1.5 million (!) views on Youtube. When she met us at Rehadapt's booth at Rehacare, we serviced her mount. In the following panel discussion she gave insights into Alternative and Augmentative Communication to a general audience.

We are glad you stopped by, Julia!

Julia Nickel with Rehadapt Engineer Marco Miftari

## Boston Children's Hospital

"We've LOVED having the flexibility of the Rehadapt rolling floor mount at bedside for our inpatient AAC service. The ability to use systems such as the Tobii i12 device pictured here (in a black case) in multiple positions at bedside with a very fast, easy and reliable position adjustment that conforms to the child's varied positions in bed has been great!"

John Costello, MA, CCC-SLP  
Director of the Augmentative Communication Program at Boston Children's Hospital  
with Uli Ehlert, CEO Rehadapt Engineering





# COMPONENTS

A wide range of components and adapters make Rehadapt products extremely versatile. No matter what Rehadapt product you own: our M3D, L3D or MagicArm systems are expandable and even combinable to give you freedom to mount any device.



**ADAPTERS**

from page 38



**SOCKETS**

from page 45



**TUBES**

from page 46



**JOINTS**

from page 48



**BASES**

from page 50

Benefits of the  
M3D system

**M3D**

from page 34

Benefits of the  
L3D system

**L3D**

from page 36

# "M3D" Monty 3D Productline

We offer a wide range of mounting possibilities for any kind of device onto any kind of wheelchair. Our system is easy to use and quick to adjust even without tools.



Vast range of wheelchair clamps



Quick coupler with magnetic guided connection



Special tubes: S-curved, L-curved and double strut

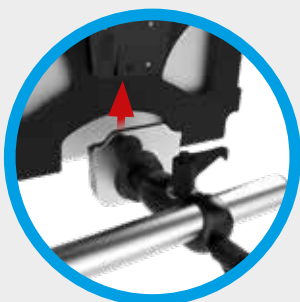

Universal Device Socket (UDS)

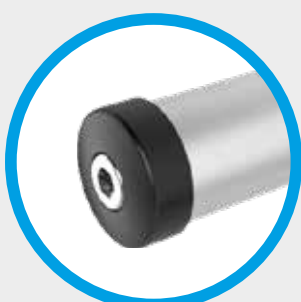

Ø 22,2 mm tubes with slipout safe guard option

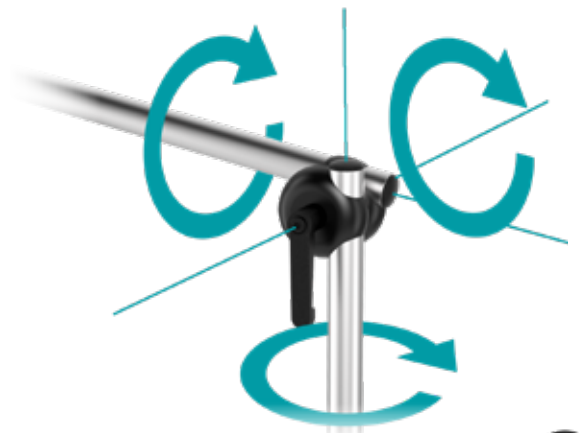

## Tube connectors



M3D-Uni



M3D-Uni QS



M3D-Folding Joint

## Swivel units



M3D Swivel Unit



M3D Swivel Unit S



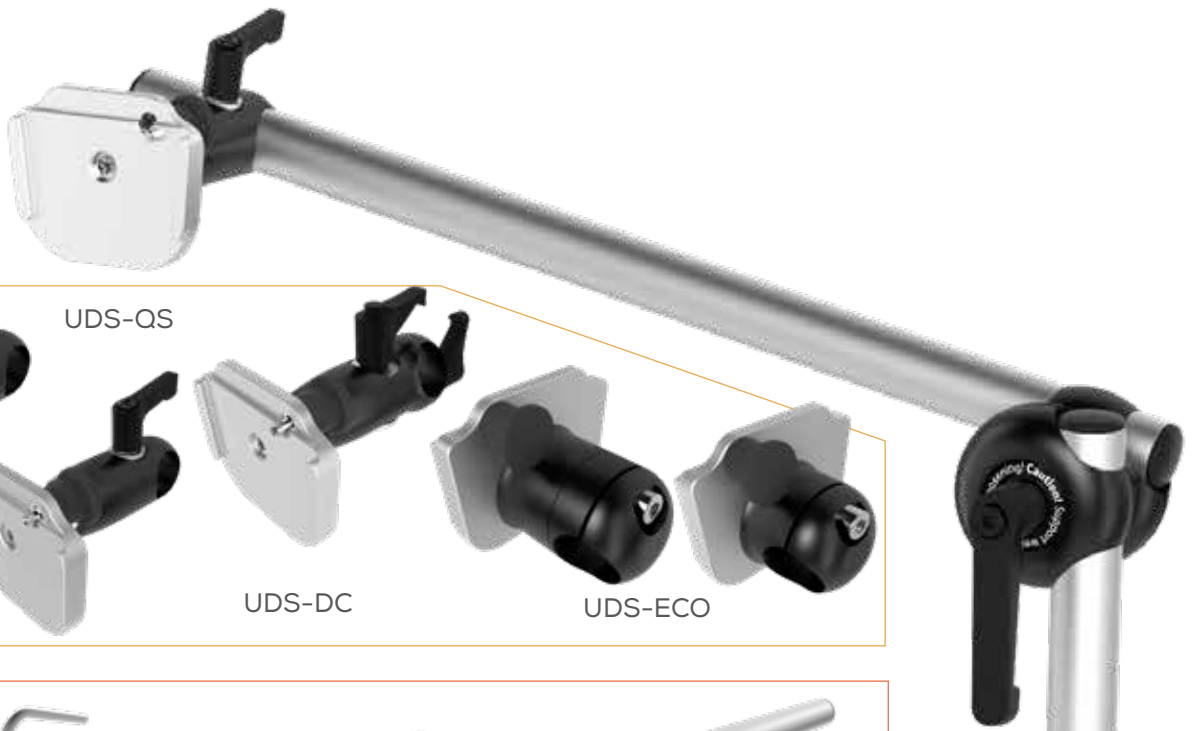

**Sockets**

UDS      UDS-QS      UDS-DC      UDS-ECO

**Tubes**

M3D S-Tubes      M3D Tubekit      M3D Tubes

M3D-HD Tubekit

Ø (7/8") 22,2 mm 200 mm (8")  
 300 mm (12")  
 400 mm (16")  
 500 mm (20")  
 600 mm (24")

**Bases**

M3D-RKL-E30      M3D-RKL-E30-70      M3D-RKL-Permobil      M3D-RKL-T-Nut 16

M3D-RKL-25-45      Sleeves 14-23

M3D-RKL-T      M3D-RKL-Unitrack



You name it - we



all iPad models



all Microsoft Surface models

**Tubes**

Ø (3/8") 10 mm	Ø (5/8") 16 mm
and (5/8") 16 mm	
(4") 100 mm	
(6") 150 mm	
(8") 200 mm	Ø (5/8") 16 mm
(10") 250 mm	(14") 350mm
(12") 300 mm	(16") 400mm

**Adapters**

**Bases** All Rehadapt frameclamps are

Sleeves  
14 - 23



Baseclamp

**Joints**

L3D 16/16	L3D 16/16 QS
L3D 16/10	L3D 16/10 QS
L3D 10/10	L3D 10/10 QS

with screw or QuickShift lever

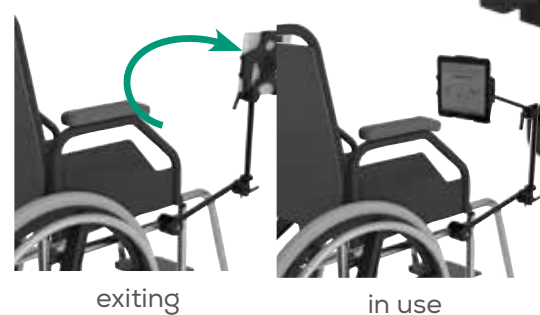

hold it! See a few examples below.



iDevices  
with Otterboxes



Samsung  
Galaxy



Universal  
Tablet  
holder



Switches e.g. Buddy  
& Specs or Jelly  
Bean

compatible to our L3D system!



MiniClamp

Superclamp



Superclamps fit to round and angular  
structures!

# "L3D" Light 3D Productline

The L3D line offers lean and sleek design while still providing the core values of Rehadapt mounts, e.g. unlimited 3D-adjustability of the joints and light and ultra strong aluminium tubes.

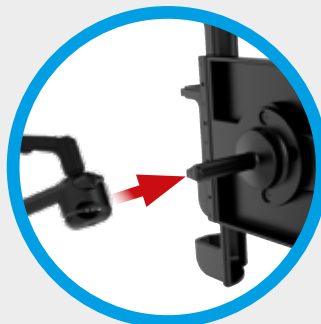

Spigot Link  
System (SLS)



Ø 10 and 16 mm  
tubes





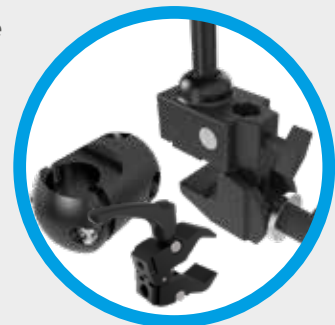



Adapter for any device  
< 1,35 kg





Superclamps, mini-  
clamps, baseclamps

# ADAPTERS

Rehadapt offers a wide range of adapters to fit onto any kind of communication device - no matter if it's a laptop, a smartphone or just a symbol book or pointing board. You can even combine different connection systems to integrate your existing mount within the Rehadapt ecosystem.

Device types					
 Communication devices	 Switches & controls	 Smartphones	 Tablets	 Laptops	 System bridges

Connection types		
 UDS	 SLS	 MA

Adapters are permanently fixed to the device. So you can:

- quickly hook them in and out of the universal device socket (UDS)
- insert them into the spigot link system (SLS)
- screw them onto the MagicArm (MA)

## for communication devices



Plan B mountable  
Clipboard

UDS	16.1201
-----	---------



Plan B mountable  
Bookstand

UDS	16.1202
-----	---------



for the  
AMD iAdapter

UDS	16.1141
SLS	14.1503



for the  
Beamz

UDS	16.1162
-----	---------

When the speech generating device is not available:  
**"Plan B"**  
mountable clipboard & bookstand to position the printed fallback communication tools.



for the Accent  
800 / 1000

UDS	16.1150
-----	---------



for the  
Wego

UDS	16.1139
-----	---------



for the Spok /  
LW SL40

UDS	16.1129
SLS	14.1502



for the LW SL35/38

UDS	16.1115
-----	---------



for the  
FRS ComLink

UDS	16.1127
-----	---------



for the Maestro, V,  
Vmax, M3 or M3max

UDS	16.1132
-----	---------



for the  
Nova Chat

UDS 16.1144



for the  
Nova Chat 8.2

UDS 16.1194



for the  
Allora

UDS 16.1116



for the  
Allora 2

UDS 16.1151



for the  
GoTalk 4+ / 9+ / 20+

UDS 16.1221



for the  
GoTalk 4+ / 9+ / 20+

SLS 14.1555  
MA 15.1007



for the GoTalk  
Express32

UDS 16.1134  
MA 15.1022



for the  
Alea CAM30NT

UDS 16.1145



for the  
Tellus Mobi

UDS 16.1121



for the  
Tellus Mobi 2

UDS 16.1138



for the  
Tellus 4

UDS 16.1137



for the  
Tellus 5

UDS 16.1187



for the Tobii  
C8, C12, C15

UDS 16.1124



for the  
AMDi iAdapter

UDS 16.1184



for the  
TDV T10

UDS 16.1183



for the  
TDV T15

UDS 16.1185



for the  
TS-DV Maestro

UDS 12.1800

## Kickstand option

Adapter plates to hook the devices easily in and out of Rehadapt's universal device socket **with integrated kickstand**. When detached from the mount you can easily use these adapters as tablestands for your device.



for the  
FL4SH

UDS 16.1131  
MS 15.1020



for the  
Grid Pad

UDS 16.1177



for the  
Zingui

UDS 16.1135



for the  
Zingui 2

UDS 16.1206

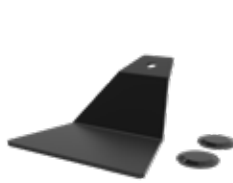

for the Pilot 2

UDS 12.1612



for the Tobii M8

SLS 14.1525



for the Tobii P10

UDS 16.1126



for the TDV I-Series

UDS 16.1168



for the Tech/Talk AMDi

UDS 16.1146



for the AbleNet Connect

UDS 16.1173



for the SuperTalker (with Velcro)

MA 15.1015



for the SuperTalker (with screws)

MA 15.1014



for the LC EyeGaze

UDS 16.1159



for the LC EyeGaze Edge

UDS 16.1197



for the LC Eyegaze Edge Talker

- 16.1021

## Adapter add-ons: brackets for Eyegaze cameras

Device adapter for eye control cameras. Applicable to tobii PCEye Mini, tobii PCEye Go, tobii PCEye Explore, ALEA Cam NT30, MyGaze, MyGaze Power, EyeTech TM5 mini and Irisbond Duo eyetracking camera.

Compatible with all of Rehadapt's tablet or notebook cradles, both with UDS or SLS interface. Also version for VESA hole pattern available.



EyeGaze bracket

UDS / SLS 16.1193



EyeGaze bracket

VESA 16.1213



Irisbond Duo

UDS / SLS 16.1207

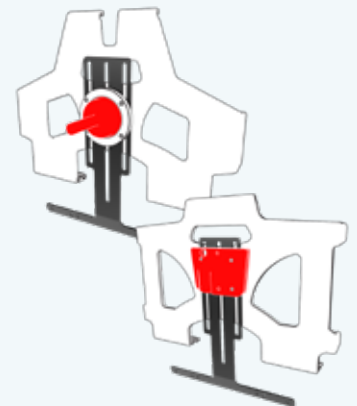



# for switches & controls



Rod Ø 10 x 50 mm  
(3/8" x 2") with 1/4"  
threading

SLS	14.9511
-----	---------



for the  
PikoButton

SLS	14.1582
-----	---------



for parts with thread  
1/4" UNC

SLS	14.1563
MA	15.1004



for holes  
with Ø6 - 8 mm  
(1/4" - 1/3")

SLS	14.1587
-----	---------



for the  
Lib Switch

SLS	14.1509
MA	15.1021



for the James,  
AMDi PartnerPlus / 4,  
Wobble

SLS	14.1583
-----	---------



headless screw for the  
MagicArm

MA	01.0012
----	---------



L3D16 tube connector for  
MagicArm adapters

MA	15.1018
----	---------



for the Unlimited  
Crystal Clear

MA	15.1010
----	---------



for the AbleNet  
Buddy Button,  
Specs & Candy Corn

SLS	14.1508
MA	15.1006



for the AbleNet  
Jelly Bean

SLS	14.1506
MA	15.1003



for the AbleNet  
Big Red

SLS	14.1507
MA	15.1002

## With 3D joint

These adapters include a 3D joint for mounting onto 10 mm (3/8")  
Rehadapt's L3D system



for the  
AbleNet Mini Joystick

SLS	14.1584
-----	---------



for proximity sensor

SLS	14.1585
-----	---------



for the AbleNet  
pneumatic switch

SLS	14.1586
-----	---------



for the  
Abilia Control Omni

SLS	14.1504
-----	---------

## Simon

Kennedy Films has announced that the London Screenwriters' Festival has presented Simon Fitzmaurice, writer and director of My Name is Emily, with a lifetime achievement award.

We are glad to see our Rehadapt mount helping people to excel oneself. It is our dedication to create great products with passion to help people to live their passions as well.

*Lifetime achievement award for  
Simon Fitzmaurice*



# for smartphones



Due to the relative light weight of smartphones, our smartphone holders include the spigot link system (SLS) and are mainly used with L3D mounts.

<b>Apple iPhone</b> 	iPhone 4, 4s	14.1501
	iPhone 5, 5s	14.1515
	iPhone 6/7, 6/7s	14.1537 (in use with Defender Case 14.1572)
	iPhone 6/7 Plus, 6/7s Plus	14.1568 (in use with Defender Case 14.1567)

<b>Universal</b> 	for small smartphones	width: 49 - 63 mm (2" - 2 1/2") thickness: 9 - 13 mm (3/8" - 1/2")	14.1541
	for medium smartphones	width: 62 - 77 mm (2 1/2" - 3") thickness: 9 - 13 mm (3/8" - 1/2")	14.1542
		width: 62 - 77 mm (2 1/2" - 3") thickness: 14 mm (1/2")	14.1601
	for large smartphones	width: 75 - 89 mm (3" - 3 1/2") thickness: 9 - 13 mm (3/8" - 1/2")	14.1543
		width: 60 - 80 mm (2 1/2" - 3 1/8") thickness: 14 mm (1/2")	14.1602

# for tablets

	System: Otterbox:	UDS		SLS		MA		order OtterBox only
		without	with	without	with	without	with	
<b>Apple iPad</b> 	iPad 1	16.1130		14.1548				
	iPad 2	16.1133	16.1158	14.1500	14.1524	15.1024	15.1029	01.7010
	iPad 3	16.1133	16.1158	14.1500	14.1524	15.1024	15.1029	01.7010
	iPad 4	16.1133	16.1158	14.1500	14.1524	15.1024	15.1029	01.7010
	iPad 5	16.1157	16.1160	14.1514	14.1526	15.1026		01.7098
	iPad 6	16.1157	16.1160	14.1514	14.1526	15.1026		01.7098
	iPad Air 1	16.1157	16.1160	14.1514	14.1526	15.1026		01.7018
	iPad Air 2	16.1171	16.1181	14.1545	14.1559	15.1028		01.7038
	iPad Mini 1	16.1167	16.1174	14.1519	14.1551	15.1025		01.7011
	iPad Mini 2	16.1167	16.1174	14.1519	14.1551	15.1025		
	iPad Mini 3	16.1167	16.1174	14.1519	14.1551	15.1025		01.7039
	iPad Mini 4	16.1198	16.1222	14.1581		15.1030		01.7019
	iPad Pro 9,7"	16.1171		14.1545	14.1526			01.7085
	iPad Pro 10,5"	16.1214	16.1215	14.1603	14.1604			01.7100
	iPad Pro 12,9"	16.1188	16.1196	14.1565	14.1570			01.7087

		UDS	SLS
<b>Samsung Galaxy</b> 	Note Pro 12	16.1175	14.1554
	Tab 3 (7")		14.1550
	Tab 3 (8")		14.1556
	Tab 3 (10,1")		14.1553
	Tab 4 (7")		14.1552
	Tab 4 (10,1")		14.1544
	Tab A (9,7")	16.1186	14.1560
<b>Dell</b>	Venue 11 Pro	16.1166	14.1539
<b>Microsoft</b> 	Surface 3	16.1178	14.1565
	Surface 3 Pro	16.1165	14.1538
	Surface 4 Pro / Surface Pro 2017	16.1189*	14.1566#
<b>universal</b> 	Tab Tite Mini (for 7" tablets)	16.1195	14.1571
	Tab Tite (for 10" tablets)	16.1180	14.1549

\*for use with a Survivor case choose 16.1203 #for use with a Survivor case choose 14.1589

## Universal Tablet Holder

Highly adjustable tablet holder for mounting any tablet from 7" to 13", with and without protective case, with a maximum thickness of 36 mm (1 1/2"). UDS 16.1220

With its ingenious design, the Universal Tablet Holder keeps a firm hold on your tablet. The five holding points secure the device with minimal contact so that all connections are freely accessible and the view of the display remains unimpaired.

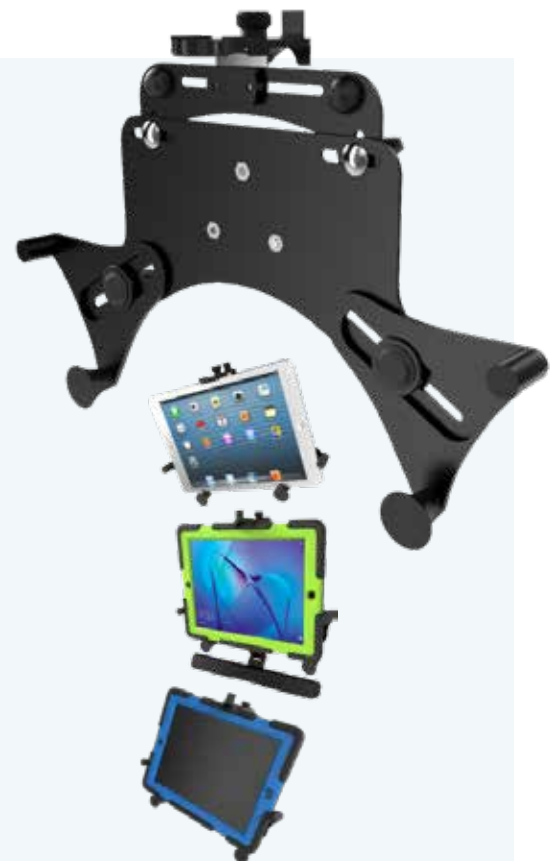
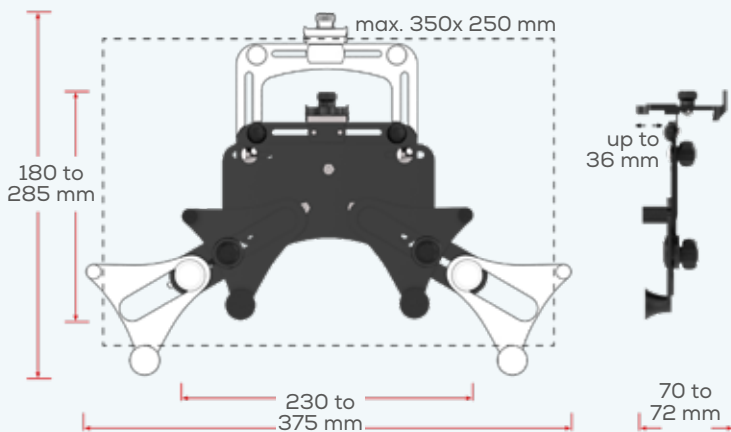

Can be combined with eye-tracker adapters. Fits tablets with and without protective cases (up to a maximum thickness of 36 mm).

# for laptops



for the Dell Latitude 10  
(with Survivor case)

UDS	16.1149
-----	---------



for the Dell Latitude 10  
ST2

UDS	16.1154
-----	---------



for the  
Dell XPS 12

UDS	16.1152
-----	---------



for the  
Dell XPS 18

UDS	16.1153
-----	---------



Laptop tray  
430 mm x 315 mm

UDS	16.1163
SLS	14.1535



for mounting notebooks  
from 10" - 14"

UDS	16.1136
-----	---------



for mounting notebooks  
from 15" - 17"

UDS	16.1140
-----	---------

# system bridges

## AMPS hole pattern

The AMPS hole pattern is an industry standard configuration. It consists of four holes located in a rectangular pattern spaced at 30.17 mm by 46.05 mm. It is common for the AMPS pattern to consist of multiple holes to allow vertical or horizontal implementation. For hand-held and tablet-sized devices, many cradles, brackets and protective cases (e.g. LifeProof) use the AMPS system.



UDS	16.1169
-----	---------



SLS	14.1546
-----	---------



MA	15.1027
----	---------

## Velcro fastener

The famous hook-and-loop Velcro fastener consists of two components: a lineal fabric strip with tiny hooks that could "mate" with another fabric strip with smaller loops, attaching temporarily, until pulled apart. Perfect for attaching devices to our mounting system when no screws can be used.



116 mm x 135 mm

UDS	16.1148
SLS	14.1512



110 mm x 50 mm

SLS	14.1558
-----	---------

## VESA hole pattern

The VESA standard has typically square hole patterns for flat panel displays.



75 mm x 75 mm

UDS	16.1117
-----	---------



100 mm x 100 mm

UDS	16.1123
-----	---------

## Adhesive tape

Permanent fixation with strong adhesive tape. Perfect for attaching devices to our mounting system when no screws can be used.



116 mm x 135 mm

UDS	16.1147
SLS	14.1511

# SOCKETS

"The mother of all sockets" - our universal device socket (UDS) includes our quick release mechanism which allows for the safe device attachment within seconds. The footprint on the device is minimal, yet great sturdiness is achieved!



Choose the (degrees of) freedom you need!

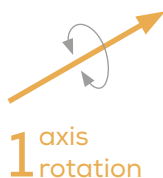

## UDS Eco

The most economic & compact version of Rehadapt's quick release system: sitting directly on the tube. Allows for the rotation around the tube axis. Fastened with a bolt.

16.1004

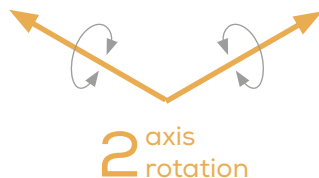

## UDS Eco Plus

Excellent compromise between economic yet flexible use of Rehadapt's quick release system. Allows for the rotation around the tube axis and the twisting of the screen. Fastened with a bolt.

16.1005

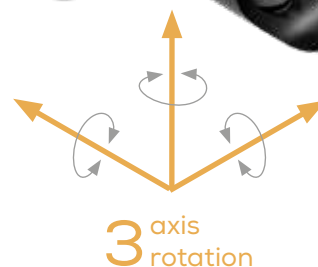

## UDS 22

Rehadapt's signature quick release system with ball-joint.



"UDS 22"  
Fixation with a bolt.

16.1000

## System bridges

Combine your existing mounting elements with Rehadapt's ecosystem.



### VESA

Adapter for mounting devices on VESA 75 or 100 fittings. Enables 3rd party monitor holders to carry Rehadapt devices. Allen wrench included.

16.1010



### Daessy

Adapter piece to mount devices with Daessy adapters. UDS not included.

16.1020



### L3D

Universal Device Socket (UDS) with Spigot Link to use UDS-adapted devices on Rehadapt's Light 3D line.

14.1516



"UDS 22 QS"  
Quick fixation with a lever.

16.1050



"UDS 22 DC"

Two levers for separated fixation of the ball-joint and tube-clamp. So the weight of the device remains supported during repositioning.

16.1051







# TUBES

Rehadapt offers tubes with different diameters and shapes for the M3D and L3D lines of products. All tubes are made of aircraft-grade aluminum. That makes them extremely sturdy while maintaining a light weight and ensuring an accurate surface. Their perfectly round precision manufacturing translates into maximum force fit at any clamp.

M3D22	L3D16	L3D10
Ø 22,25 mm (7/8")	Ø 16 mm (5/8")	Ø 10 mm (3/8")

## straight



Length	M3D22		L3D16	L3D10
	100 mm (4") 			14.9500
150 mm (6") 			14.9501	14.9513
200 mm (8") 	01.5005	01.5505*	14.9502	14.9514
250 mm (10") 			14.9503	14.9515
300 mm (12") 	01.5010	01.5510*	14.9504	14.9516
350 mm (14") 			14.9505	14.9517
400 mm (16") 	01.5020	01.5520*	14.9506	
500 mm (20") 	01.5030	01.5530*		
600 mm (24") 	01.5031			

\*slip-out-safeguards included



### Slip-out-safeguard-kit

Prevents the tube from slipping out unintentionally.

Two slip-out safeguards with screws for Ø 22,25 mm (7/8") tubes (thickness: 2,3 mm). Allen wrench not included. 01.5500



### Standard end-plugs

Replacement end-plugs.

for M3D22 tubes  
01.5999

for L3D16 tubes  
01.5998



# curved



## S-Tubes

S-curved tubes with a diameter of 22,25 mm (7/8") for extra clearance and offset without the need of additional joints.

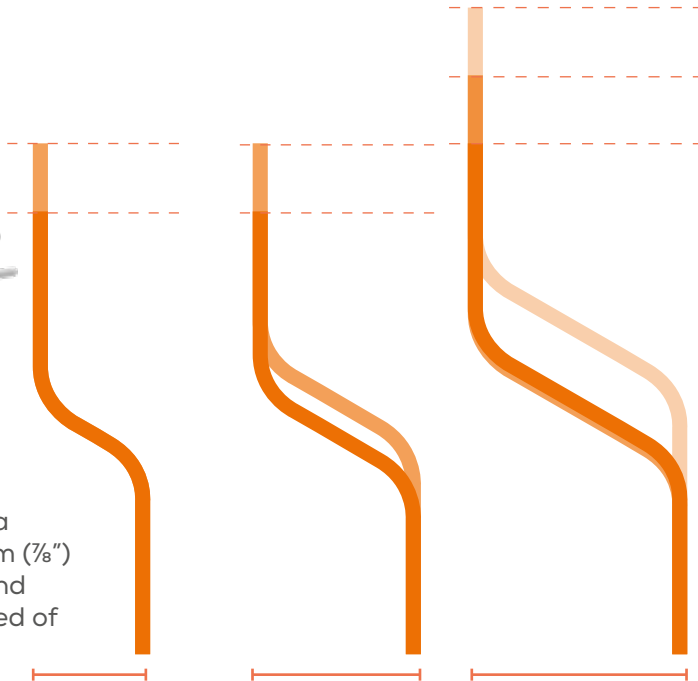

Length	152 mm (6") offset	228 mm (9") offset	304 mm (12") offset
660 mm (26")	01.5650	01.5660	
762 mm (30")	01.5662	01.5664	01.5670
863 mm (34")			01.5680
965 mm (38")			01.5690

## L-Tube

L-curved tubes with a diameter of 22,25 mm (7/8") for an angled positioning without the need of additional joints.

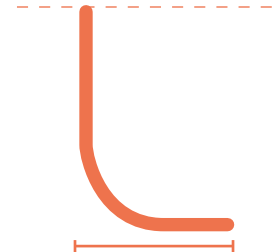

Height: 275mm (11").  
Offset: 190mm (7,5").

12.5403

# kits



## M3D tube-kit

Standard set of M3D22 tubes. Includes three tubes with lengths of 200 mm (8"), 400 mm (16") and 500 mm (20").

11.1400



## M3D HD upgrade-kit

Upgrade kit to equip any M3D mount with a double M3D22 tube. Significantly reduces vibration, allows for heavy devices on long mounts.

11.1403



## Easy-off-kit

Allows the quick removal of the entire mount directly at the wheelchair frame. Only suitable for double tube mounts.

11.1510

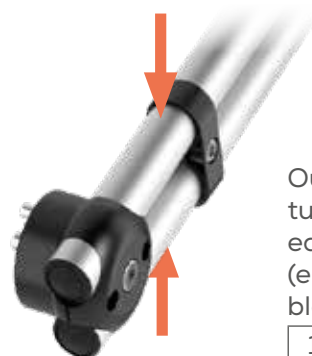





Our easy-off-kit holds the two tubes at the exact distance to easily fit them into the base (e.g. M3D-1-Base Special Double Tube).

11.1105

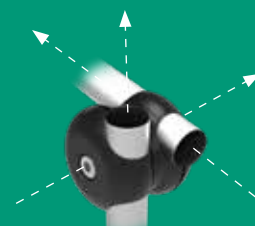
# JOINTS

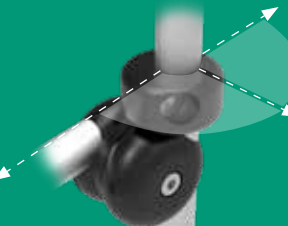
The connection of the tubes are critical in many ways. The flexibility of the joints define the versatility of the entire mount, and the force the connection points can take define the overall sturdiness.

 <p><b>3D joints</b> full 360° adjustment in all dimensions</p>	 <p><b>Folding joints</b> move a device easily up and then to the side</p>	 <p><b>Swivel joints</b> swing your mounts be- tween different positions</p>	 <p><b>Fixed joints</b> connect tubes at a fixed angle</p>
--	---	--	---

Rehadapt's signature joints combine maximum strength and flexibility with very intuitive operation. They can connect all three types of Rehadapt tubes. All joints are available with different options like with Allen screws, QuickShift levers or with an extra screw for locking the tube while still allowing movement.

## 3D joints

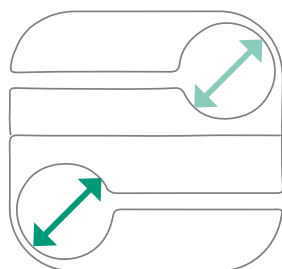

Tube diameter from/to



		screw	screw & lock	lever	lever & lock
		Adjusting the joint with an Allen bolt	Additional Allen bolt to lock the tube's movement	Adjustable without tools	Additional Allen bolt to lock the tube's movement
<b>M3D22</b>	<b>M3D22</b>	11.1300		11.1350	11.1355
	<b>L3D16</b>	14.1203		14.1253	
	<b>L3D10</b>	14.1204		14.1264	
<b>L3D16</b>	<b>L3D16</b>	14.1200	14.1257	14.1250	14.1254
	<b>L3D10</b>	14.1201	14.1258	14.1251*	14.1255
<b>L3D10</b>	<b>L3D10</b>	14.1202	14.1259	14.1252	14.1256

\*variant with a smaller lever for a smaller footprint (14.1271)

## Folding joints



### Fold down unit LEFT

Fold down unit to move the device easily up and then to the side of the wheelchair. For left side mounting.

M3D22 11.1321



### Fold down unit RIGHT

Fold down unit to move the device easily up and then to the side of the wheelchair. For right side mounting.

M3D22 11.1320



# Swivel joints

Our swivel joints let you easily swing the mount between predefined positions. Just open the QuickLock lever and lift the mount upwards. Due to the adjustable clamping force of the lever this can even be performed by the user himself.

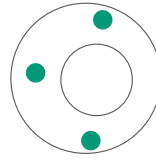
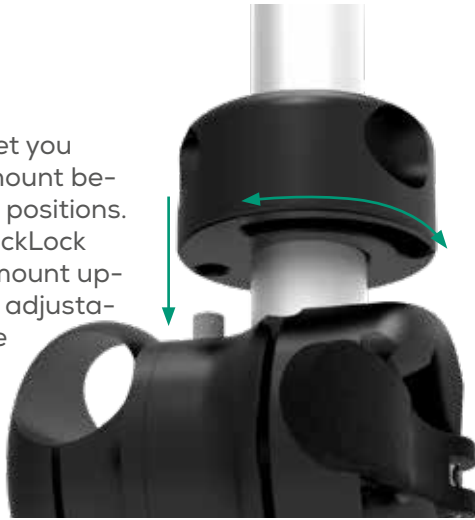

## Indexing "latch"

Swing the mount to predefined positions by latching the pin into one of the three holes.



## Indexing "slot"

Swing the mount to predefined positions by latching the pin into the parking position and slide smoothly between operating and exiting position.



**M3D22 to M3D22** joint.  
With indexing latch.

M3D22 11.1200



**M3D22 to M3D22** joint.  
With indexing slot  
and QuickLock lever.

M3D22 11.1220



**M3D22 to L3D16** joint.  
With indexing slot  
and QuickShift lever.

L3D16 14.1222



**L3D16 to L3D16** joint.  
With indexing slot  
and QuickShift lever.

L3D16 14.1220



Indexing latch  
for M3D22 tubes

M3D22 11.1250



Indexing slot  
for M3D22 tubes

M3D22 11.1251



Indexing slot  
for L3D16 tubes

L3D16 14.1225

# Fixed joints



**180°**  
longitudinal

Connector for  
extending tubes

M3D22 11.1522



**90°**  
orthogonal

Connects tubes  
orthogonally

M3D22 11.1390



**65°**  
acute-angled

Connects tubes  
at a 65° angle

M3D22 11.1330



**0°**  
parallel

Connects tubes parallelly  
(for double-tube HD systems)

M3D22 11.1500

# BASES

Each base consists of two or three parts. There is always a frameclamp and a tube socket. Optionally you can add extensions in-between: offset spacers, a 90° angle or a coupler.

**Frameclamps**  
Base-half clamping directly on the wheelchair frame

**Extensions** (OPTIONAL)  
Choose between offset spacers, 90° angle or coupler

**Tubesockets**  
Base-half clamping the first tube of your mounting system

**Preconfigured**  
complete bases ready to use on standard situations

## Frameclamps

Rehadapt offers the highest precision for clamping on a plethora of wheelchair frames with different profiles, diameters and sizes.

**Round clamps**  
Frameclamps for wheelchair frames with a round profile.

**Round & semi-open**  
Applicable when the frame tube is partially obstructed (e.g. overlying seat).

### "M3D RKL"

Rehadapt standard frameclamp for use in most common situations. Extendable with different sleeves to fit especially small or oval-shaped tube profiles.



Ø 25 mm	11.1125
Ø 26 mm	11.1126
Ø 28 mm	11.1128
Ø 29 mm	11.1129
Ø 30 mm	11.1130
Ø 32 mm	11.1132
Ø 34 mm	11.1134

Ø 35 mm	11.1135
Ø 36 mm	11.1136
Ø 38 mm	11.1138
Ø 40 mm	11.1140
Ø 42 mm	11.1142
Ø 45 mm	11.1145

### "M3D RKL-T"

Rehadapt semi-opened clamp for use in situations where the tube is not fully accessible.

**Not compatible with sleeves.**



Ø 16 mm	11.1416
Ø 19 mm	11.1419
Ø 20 mm	11.1420
Ø 21 mm	11.1421
Ø 22 mm	11.1422
Ø 23 mm	11.1423
Ø 24 mm	11.1424

Ø 25 mm	11.1425
Ø 26 mm	11.1426
Ø 27 mm	11.1427
Ø 28 mm	11.1428
Ø 29 mm	11.1429
Ø 30 mm	11.1430
Ø 32 mm	11.1432

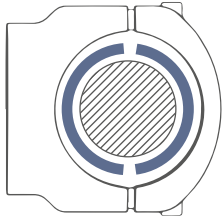

## Sleeves

Sleeves to support different diameters of frame tubing.  
**Only for round frameclamps.**

Sleeves for tubes smaller than 25 mm (use with 11.1125)

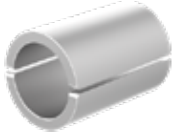

Ø 25 mm to 19 mm	01.2519
Ø 25 mm to 20 mm	01.2520
Ø 25 mm to 21 mm	01.2521
Ø 25 mm to 22 mm	01.2522
Ø 25 mm to 23 mm	01.2523



Sleeves for the oval frame tubes of the Sunrise Medical wheelchair (use with 11.1136)

Ø 36 mm to 33 x 26,5 mm 01.3633



Sleeves for the oval frame tubes of the Rifton Pacer wheelchair (use with 11.1145)

Ø 45 mm to 44,5 x 22,25 mm 01.3634



Sleeves for the oval frame tubes of the R82 wheelchairs (e.g. Multiframe) (use with 11.1140)

Ø 40 mm to 40 x 21 mm 01.4021

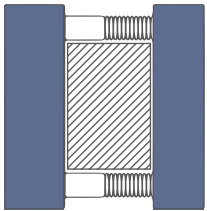

## Rectangular clamps

Frameclamp for rectangular wheelchair frame elements with different thicknesses.



"RKL E30"

for up to 30 mm 11.1065



"RKL E30-70"

for 30 to 70 mm 11.1060

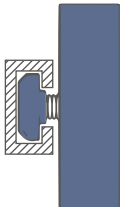

## T-Nut rails

Frameclamps with T-nuts for C-profile railings. Commonly suitable for powered wheelchairs.



"M3D T-Nut 16/6,5"  
Max. 16 mm ( $\frac{5}{8}$ ") x 6.5 mm ( $\frac{1}{4}$ "). Suitable for the powered wheelchairs from "Quantum" and "Invacare".

11.1069



"M3D Permobil UniTrack"  
for Permobil UniTrack rail / double T-nut system.

11.1068



"M3D T-Nut 10,5x4"  
max. 10,5 mm x 4 mm. Suitable for the "Quickie" powered wheelchair from "SunriseMedical".

11.1077



"M3D Item P5"  
for wheelchairs with a profile 5 railing. Suitable for some powered wheelchairs from "SKS Rehab".

11.1072



"M3D T-Nut 23/7"  
max. 23mm x 7 mm ( $\frac{15}{16}$ " x  $\frac{1}{4}$ "). Suitable for the powered wheelchair line "Balder" from "ETAC".

11.1066

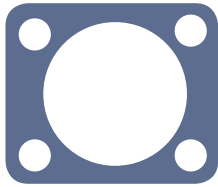

## with threaded holes

Frameclamps with threaded holes of different diameters.



### "RKL-M8-Mini"

Special frameclamp with M8 bolts to be mounted under the tie-down brackets of wheelchairs with 8 mm threaded holes.

11.1075



### "M3D RKL-M8"

Frameclamp with holes for wheelchairs with M8 threaded holes.

11.1070



### "M3D RKL-M6"

Frameclamp with holes for wheelchairs with M6 threaded holes.

11.1073



### "M3D RAD-Per Uni"

Frameclamp for the following "Permobil" chairs & seats with M6 threaded holes.

11.1062

Hexior  
Canto  
Corpus  
Corpus Jr  
Vertical  
Stander  
KB  
Lowrider  
Chairman HD  
Street  
Miniflex  
Koala  
Playman  
Robo

## Other frameclamp solutions

At Rehadapt we try to provide clamps for every possible wheelchair frame. If you can't find any fitting for your needs feel free to contact us,



for the "Madita-Fun" wheelchair from "Schuchmann".

11.1079



for the Ergotron column 51mm (2").

11.1061

with M3D22 tubemount

11.1101



for the „Kimba Neo“ stroller from „OttoBock“.

11.1071



mounting adapter to secure with bolts on any flat surface.

11.1074

## Tubesockets

for M3D22 tubes

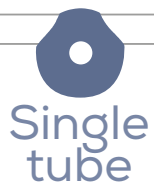

"M3D 1-Base Special"  
Mount-side half  
clamping a  
M3D22 tube

11.1102

"M3D Base Special  
Rotation Lock"  
With rotation  
lock element\*

11.1080

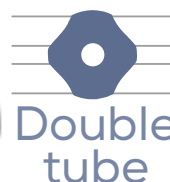

"M3D 1-Base  
Special Double Tube"  
Mount-side half clamping  
a M3D22 double-tube

11.1105

"M3D Base Special  
Rotation Lock HD"  
With rotation  
lock element\*

11.1081

\*rotation lock elements to prevent the mount from sagging when carrying heavy loads or when the mount is on the left side of the wheelchair.

## halves of M3D swivel units



"M3D 2-Swivel-Joint-S Special"

11.1222

"M3D 2-Swivel-Joint-S Special + Index"

11.1223

"M3D 2-RotLock Swivel-Joint-S Special"

11.1082

	11.1222	11.1223	11.1082
QuickLock lever	✓	✓	✓
indexing slot	-	✓	✓
rotation lock	-	-	✓

## for L3D16 tubes



Mount-side half clamping a L3D16 tube

"L3D16-Base Special" (with Allen screw)	14.1101
"L3D16-Base Special QS" (with QuickShift lever)	14.1155



"L3D swivel unit S special" Mount half of a L3D16 swivel unit with QuickShift lever

14.1221

## for L3D10 tubes



"L3D10-Base Special" Mount-side half clamping a L3D10 tube

14.1119

## Extensions

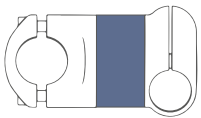

"M3D Offset Link 1" Offset spacer 25 mm (1")

11.1525



### Combinable

The offset spacers can be daisy chained if more distance is needed.

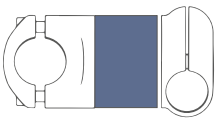

"M3D Offset Link 1 1/2" Offset spacer 38 mm (1 1/2")

11.1538

"M3D Base Adapter 90°"

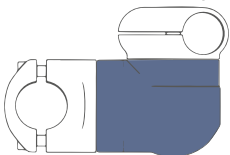

Perpendicular connector secured with Allen screws.

11.1590

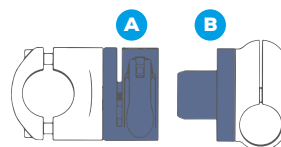

"M3D Base Coupler"

Coupler with a quick release mechanism. Connection guided by a magnet. Adds a 38 mm offset (1 1/2").

complete	11.1550
<b>A</b> inner part	11.1551
<b>B</b> outer part	11.1552

# Preconfigurations

## Standard bases

Frameclamps and tubesockets for the most common applications.



M3D22 base for frames with a round profile with a diameter of 25 mm (1")

M3D22 11.1100



L3D16 base for frames with a round profile with a diameter of 25 mm (1")

L3D16 14.1125



L3D10 base for frames with a round profile with a diameter of 25 mm (1")

L3D10 14.1103



L3D10 base for rectangular wheelchair frames (thickness up to 16 mm).

L3D10 14.1116



L3D10 base for round tubes with different diameters

10 - 10,5 mm ( $\frac{7}{16}$ "	14.1111
11 - 11,5 mm ( $\frac{7}{16}$ "	14.1115
12 - 13 mm ( $\frac{1}{2}$ "	14.1110
14 mm ( $\frac{9}{16}$ "	14.1114
15 mm ( $\frac{9}{16}$ "	14.1112
16 mm ( $\frac{5}{8}$ "	14.1113

## Swivel kits for secondary wheelchairs

Swivel joint units to prepare a secondary wheelchair for an existing M3D mount. Includes our standard frameclamp "RKL" with a diameter of 25 mm.



Simple swivel base with a M3D22 tubesocket

M3D22 11.1150



Swivel base with a M3D22 tubesocket and a QuickLock lever.

M3D22 11.1152



Swivel base with a M3D22 tubesocket, QuickLock lever and an indexing slot.

M3D22 11.1153

# SuperClamps

Our SuperClamps mount on both rectangular and round structures (e.g. boards or tubes with a diameter/thickness of 13 mm to 55 mm).

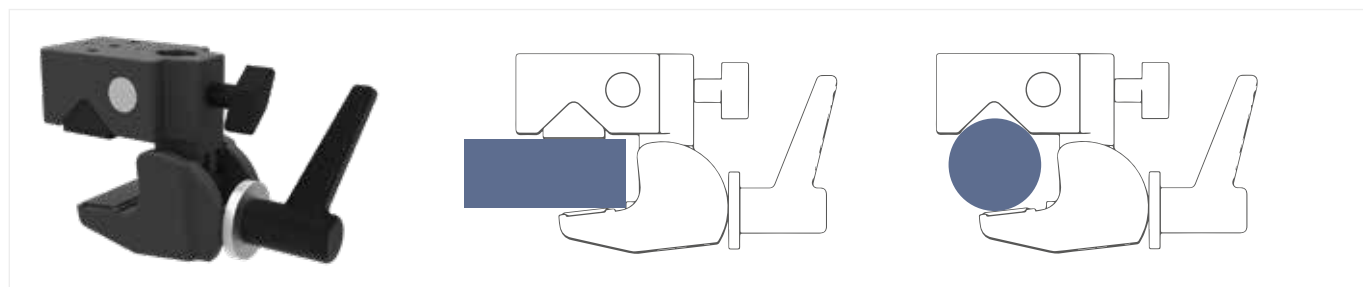

With a L3D16 pin to connect further L3D mount components

L3D16	14.1118
-------	---------



With a joint for 360° positioning freedom

L3D16 to L3D16	14.1170
L3D16 to L3D10	14.1172



With a QuickShift joint for a toolless 360° positioning freedom

L3D16 to L3D16	14.1171
L3D16 to L3D10	14.1173



With a fixed vertical fitting for L3D16 tubes

L3D16	14.1117
-------	---------



With a QuickShift. M3D22 tube connector

M3D22	12.1000
-------	---------

# MiniClamps

Small universal tube clamps for 13 mm to 35 mm tubes ( $\frac{1}{2}$ " to  $1\frac{3}{8}$ ") with rubberized clutches. Quick toolless fixation through clamping lever.



with UNC thread

L3D10	01.1008
-------	---------



with a L3D10 joint and QuickShift lever

L3D10	14.1174
-------	---------

# MagicArm clamp

Clamping for mounting the MagicArm on round wheelchair frames  $\varnothing$  25 mm (1"). Can be used with sleeves on frames from 15 mm to 24 mm ( $\frac{9}{16}$ " to  $\frac{15}{16}$ ").



with a QuickShift lever

MA	15.1012
----	---------

# What is a good **mount** without a great **service**?



**Our unique service:** we analyze your specific needs to provide you with the best mounting solution - **for free!**

## The way to your individual Virtual Mounting Solution:

- 1. Ask for it!**  
Send us pictures of your wheelchair and basic information about the chair and your device
- 2. We engineer**  
Our experienced engineers will design a custom mounting solution within just three business days
- 3. After 3 days we get back to you**  
We send you a proposal with the visualized solution photoshopped into your picture
- 4. And we deliver after 5 days!**  
We ship your pre-assembled individual solution within five business days after order

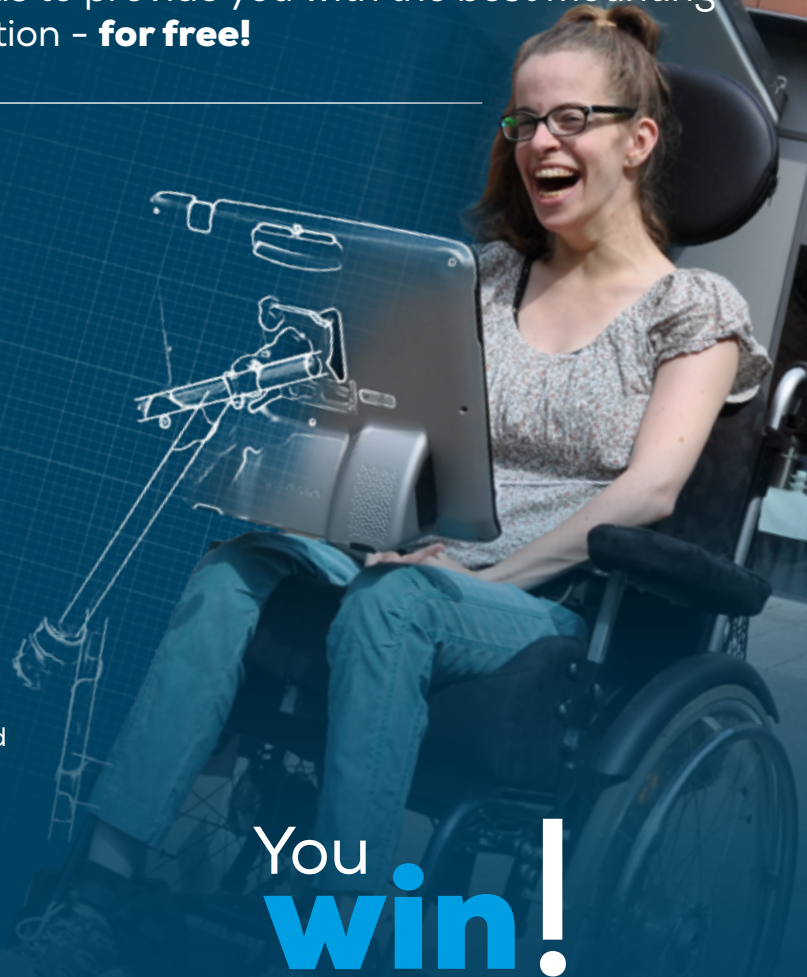

### ✓ Fast

only 3 business days and you can see a visual proposal in detailed superimposed images

### ✓ Economical

no meetings, no travelling efforts, no wait times required

### ✓ Simple

we provide illustrated assembly instructions and an easy-to-handle order ID

## Start right now!



### Online form

Just fill out online form on [www.rehadapt.com/vms](http://www.rehadapt.com/vms)



### Email

Write an email to [vms@rehadapt.com](mailto:vms@rehadapt.com)



### PDF

Download the worksheet on [www.rehadapt.com/vms-worksheet](http://www.rehadapt.com/vms-worksheet)