

Colour Command Centre™

Instruction Manual

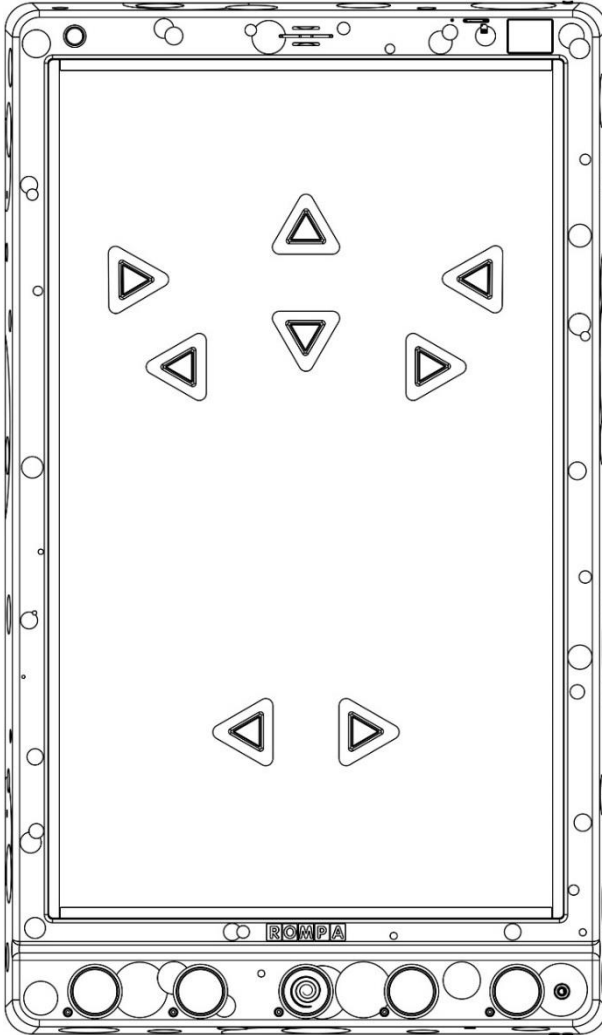

Contents

3	Panel Overview
5	Colour
5	Description
5	Technical Specification
6	Dimension
6	Contents
7	Compatible Rompa® Products
8	Operation
8	Modes
9	Touch Screen
12	Illuminated Push Buttons
14	External Switches
14	Microphone Input
15	Patterns
16	Rompa® Wireless Operation
17	Installation
23	Safety
24	Care and Maintenance
25	Troubleshooting

Panel Overview (Front)

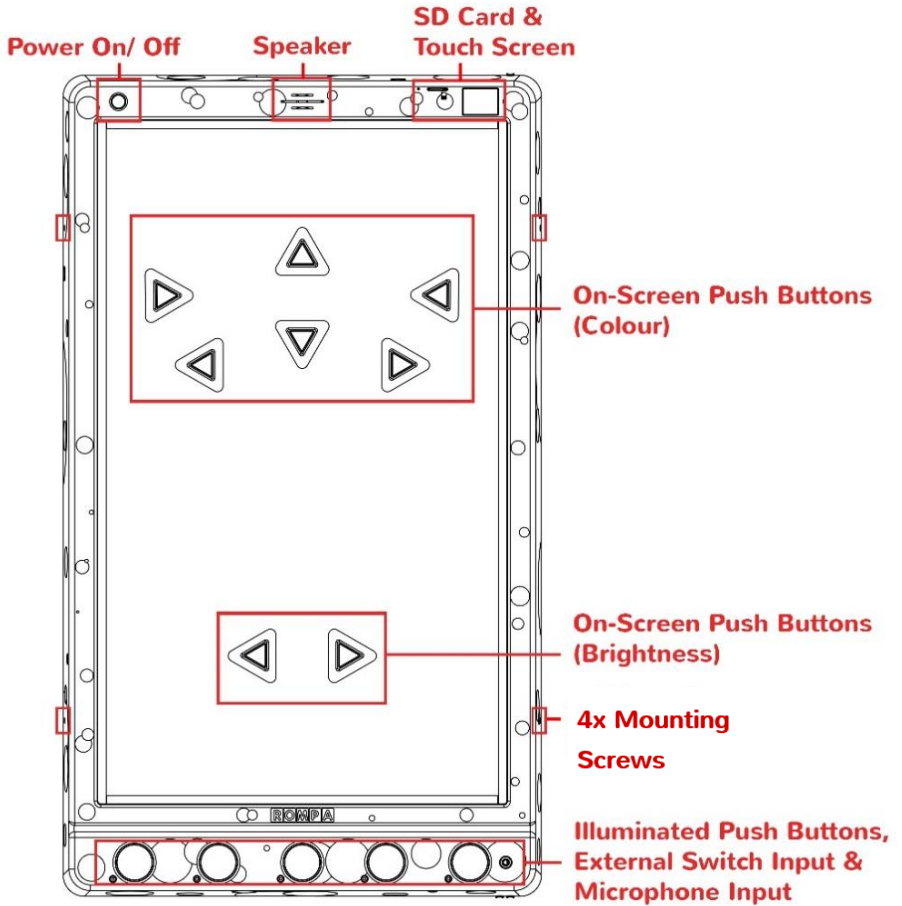

Panel Overview (Back)

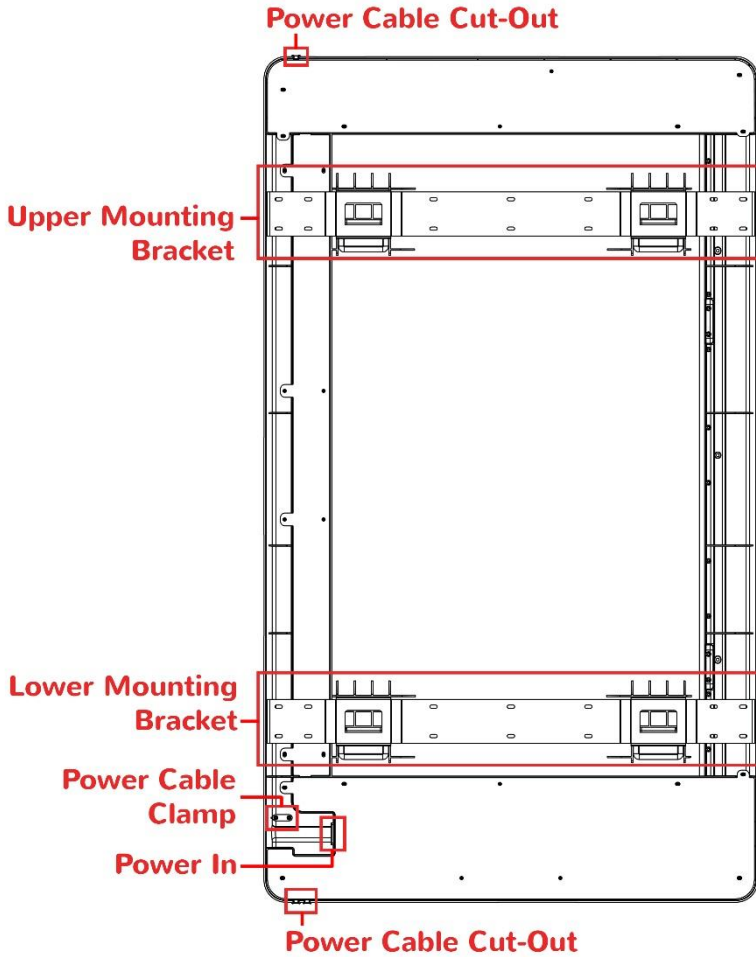

Colour

The Panel is available in 4 colours:
Black, White, Cream and Blue

Description

Rompa®'s largest interactive wireless controller. Rewarding and responsive; empowering and engaging. Navigate through a spectrum of colours, patterns and levels of brightness on the Colour Command Centre™. Be amazed as the room transforms as Rompa® wireless products change colour to match. Change the colour and brightness of the large Colour Command Centre™ display whilst Rompa® products change to match. Unique, in that this is both a Rompa® wireless controller and a Wireless Controllable product.

Technical Specification

Weight:	13.5kg
Input:	100-240V 50/60Hz
Output:	5V DC 10A
Material:	ABS (Phthalate-Free)

Dimensions

(All dimensions in mm)

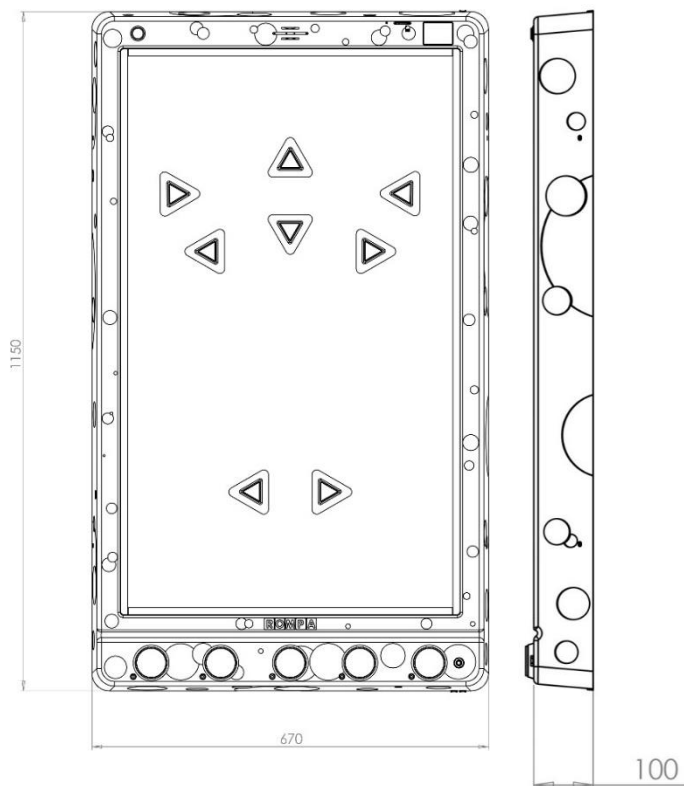

Contents

- 1x Colour Command Centre™
- 2x Wall Mounting Bracket
- 4x M4 Screws (screwed on sides)
- 1x UK Mains Lead
- 1x US Mains Lead
- 1x EU Mains Lead

Compatible Rompa® Products

Controllers

- 20848 Sensory Magic®
- 21098 Sensory Magic Portable®
- 19847 Deluxe 8 Colour Wirefree Controller
- 21006 8 Colour Wirefree Switch
- 19939 WiFi Interactive Mat Switch Set
- 18870 Talking Cube
- 20402 Mini Talking Cube
- 21917 WiFi Microphone
- 22871 Colour Command Centre™
- 21918 WiFi Override Transmitter
- 21728 Rompa® WiFi App Control Box
- 22716 Rompa® WiFi Colour Control Bumpas – set of 8

Receivers

- 22869 Multifinity Panel™
- 22871 Colour Command Centre™
- 22872 Fireworks Extravaganza™
- 22870 Sound to Sight Showtime™
- 22874 Double Bubble Bonanza
- 22873 Colour Catch Combo™
- 22875 Hip Hop Activity Box™
- 19771 Midi Bubble Tube
- 19772-5 Maxi Bubble Tube
- 19777-80 Aquatic Bubble Tube
- 19776 Giant Maxi Bubble Tube
- 19767-770 Ball-Bubble Tube
- 19210 Light Source
- 21452 Two Port Light Source
- 20287 Wi Fi Starry Sky Panel
- 20878 Wi Fi LED Spotlight
- 20845 Wi Fi Mood Lighting
- 21002 Wi Fi Strip Light System

Operation

Modes

The mode dictates how the panel behaves. The Colour Command Centre™ has 2 modes which can be selected and an additional mode when one or two microphones are plugged into the ¼"/6.35mm microphone input:

Mode 1: Interactive

The panel does not change current pattern or colour unless told to do so via the illuminated push buttons.

Mode 2: Relax (Passive)

The panel scrolls through patterns and colours. The panel changes state after 1 minute of inactivity. The panel can be used as normal in this mode.

Microphone Mode: Sound Colour Change

This mode cannot be accessed via the touch screen. To access this mode plug a microphone into the ¼"/6.35mm microphone input. The panel will automatically change to microphone mode once a microphone has been detected. The mode and brightness of the panel cannot be adjusted via the touchscreen whilst a microphone is plugged in.

Panel acts as mode 1 however every time the microphone detects a distinct sound the panel and therefore other Rompa® wireless products change colour too.

Touch Screen

The touch screen is intended for the supervisor of the session not the primary user of the panel. The touch screen allows you to control in detail how the panel behaves as well as view statistics of panel usage.

Upon booting the panel up it will revert to its default settings:

Mode 1: Interactive

Volume: 2

Touch Screen Brightness: 100%

Panel Brightness: 100%

Sound Effects: On

WiFi: On

Lock: Off

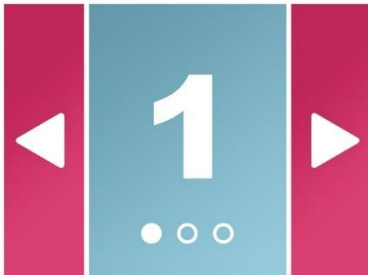

Mode

Press the light blue mode button to cycle through the modes of the panel.

Press the red forward or back buttons to cycle through the other menu options.



Media*

Press the 'play/ pause' button to play or pause music. Press the 'skip forward' to play the next track or 'skip back' to play the previous.

Press the Red forward or back buttons to cycle through the other menu options.

*This functionality may only be available when an SD card has been inserted.



Volume

Pressing the '+' will increase the volume and pressing '-' will reduce the volume.

Press the red forward or back buttons to cycle through the other menu options.



Sound Effects

Pressing the light green sound effect button will cycle the sound effects on or off. Sound effect refers to the sounds made when the user activates the illuminated push buttons.

Press the red forward or back buttons to cycle through the other menu options.



Touch Screen Brightness

Pressing the yellow screen brightness button will cycle the panel through 6 levels of brightness to 100%.

Press the red forward or back buttons to cycle through the other menu options.

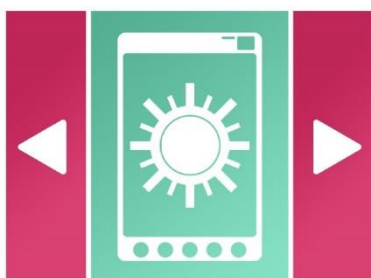

Panel Brightness

Pressing the turquoise screen brightness button will cycle the touch screen through 3 levels of brightness to 100%.

Press the red forward or back buttons to cycle through the other menu options.



Lock

Pressing the red lock button will lock and unlock the illuminated push buttons. When locked the push buttons will dim and be unresponsive.

Press the red forward or back buttons to cycle through the other menu options.



Wireless

Pressing the purple wireless button will cycle the panel wireless on or off. With wireless turned on the panel will respond to other Rompa® compatible wireless products. With wireless turned off it will ignore Rompa® compatible wireless products.

Press the red forward or back buttons to cycle through the other menu options.



Stats

Pressing the blue stats button will open the stats screen.

From the stats screen you can see in real time the amount of button presses that have been made on the panel and the duration the panel has been used for.

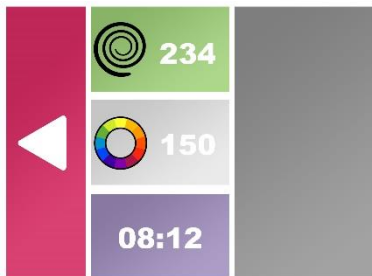

To return to the main menu, press the red back button.

Press the red forward or back buttons to cycle through the other menu options.

Illuminated Push Buttons

The Colour Command Centre™ has 5 illuminated push buttons built into the chassis and 8 illuminated push buttons built into the screen.

Chassis buttons when pressed will flash and a unique sound effect will be triggered. On-screen buttons when pressed will not flash but will trigger a unique sound effect. Sound effects can be turned off via the touch screen. All illuminated buttons can be locked via the touch screen if required. The brightness of the illuminated buttons is reduced and the buttons are unresponsive when locked.



Red

Turn the panel Red via the 'Red' illuminated push button or an external switch plugged into the 'Red' input jack.



Green

Turn the panel Green via the 'Green' illuminated push button or an external switch plugged into the 'Green' input jack.



Pattern

The panel has 6 patterns which can be selected via the 'Pattern' illuminated push button or an external switch plugged into the 'Pattern' input jack.



Blue

Turn the panel Blue via the 'Blue' illuminated push button or an external switch plugged into the 'Blue' input jack.



Yellow

Turn the panel Yellow via the 'Yellow' illuminated push button or an external switch plugged into the 'Yellow' input jack.



Red Hue Up

Increase the red hue of the panel via the 'Red Hue Up' illuminated on-screen push button.



Red Hue Down

Decrease the red hue of the panel via the 'Red Hue Down' illuminated on-screen push button.



Green Hue Up

Increase the Green hue of the panel via the 'Green Hue Up' illuminated on-screen push button.



Green Hue Down

Decrease the Green hue of the panel via the 'Green Hue Down' illuminated on-screen push button.



Blue Hue Up

Increase the Blue hue of the panel via the 'Blue Hue Up' illuminated on-screen push button.



Blue Hue Down

Decrease the blue hue of the panel via the 'Blue Hue Down' illuminated on-screen push button.



Brightness Down

Decrease the brightness of the panel via the 'Brightness Down' illuminated on-screen push button.



Brightness Up

Increase the brightness of the panel via the 'Brightness Up' illuminated on-screen push button.

External Switches

The panel has 5 external switch inputs each located underneath their associated illuminated push button. To connect the external switch simply plug into the ¼"/6.35mm jack and remove when finished (external switches without a ¼"/6.35mm jack may need an adapter fitting).

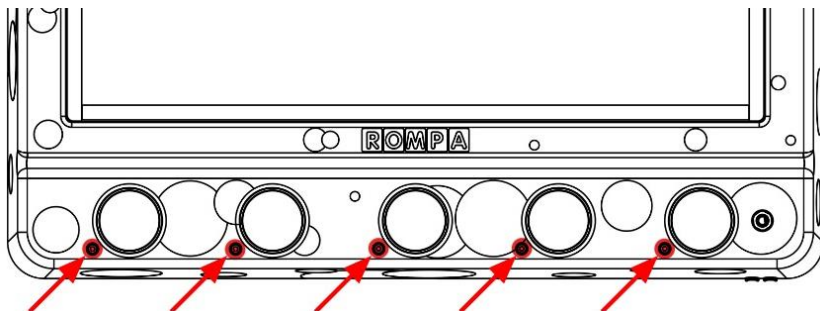

Microphone Input

The panel has 1 microphone input. To use a microphone with the panel simply plug a microphone into the ¼"/6.35mm jack located in the bottom right of the panel. When the microphone is inserted the panel will automatically detect its presence and turn to 'Microphone Mode'. The panel also acts as a karaoke and sounds spoken through the microphone can be heard through the integrated speaker. Simply remove the microphone from the panel when finished and the panel will automatically revert back to its previous mode.

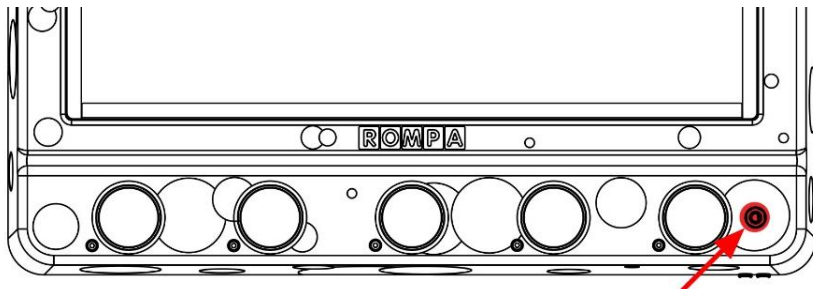

Patterns

The panel has 6 patterns which can be selected via the 'Pattern' illuminated push button or an external switch plugged into the 'pattern' input jack:

- 1 **No Pattern**
All LEDs are illuminated with no change.

- 2 **Slow Fade**
All LEDs will fade in and out.

- 3 **Sparkling**
Random pixels fade in and out to create a magical sparkling effect.

- 4 **Fill**
Panel gradually fills with LEDs in column order. Once filled the panel gradually extinguishes the LEDs in reverse order to repeat.

- 5 **Looping**
Columns of LEDs travel up and down the panel in alternating directions.

- 6 **Wipe**
A band of LEDs starting at the top of the panel travel down to the bottom of the panel. The band of LEDs extinguish at the bottom of the panel and the pattern then repeats.

Rompa® Wireless Operation

The Colour Command Centre™ is compatible with a range of Rompa® wireless products (see Compatible Rompa® Products):

8 Colour Wirefree Controller Simple and Deluxe

Pressing the colour buttons turns the panel the corresponding colour selected. The panel will remain this colour unless a new colour is selected via the panel or a Rompa® wireless controller or the panel is in a passive mode where it continue cycling through colours and patterns after 60 seconds.

Pressing the central 'function button' acts as pressing the pattern button on the panel. Pressing the function button multiple times allows the user to cycle through all 6 of the panel's patterns.

Other Wireless Products

Selecting a colour turns the panel the corresponding colour selected. The panel will remain this colour unless a new colour is selected via the panel or a Rompa® wireless controller or the panel is in a passive mode where it continue cycling through colours and patterns after 60 seconds.

Installation

Installing Wall Mount Brackets & Panel

Ensure that, after installation, the mains plug and/or power switch for the Panel is easily accessible to facilitate removal of power.

Due to the size of the product it is recommended that it is installed by two people.

Recommended Tools

- Drill
- Spirit Level
- Pencil
- Tape Measure
- Appropriate Fixings (E.g. Wall Plugs, etc)

(All dimensions in mm)

MAX screws in total per bracket: 14

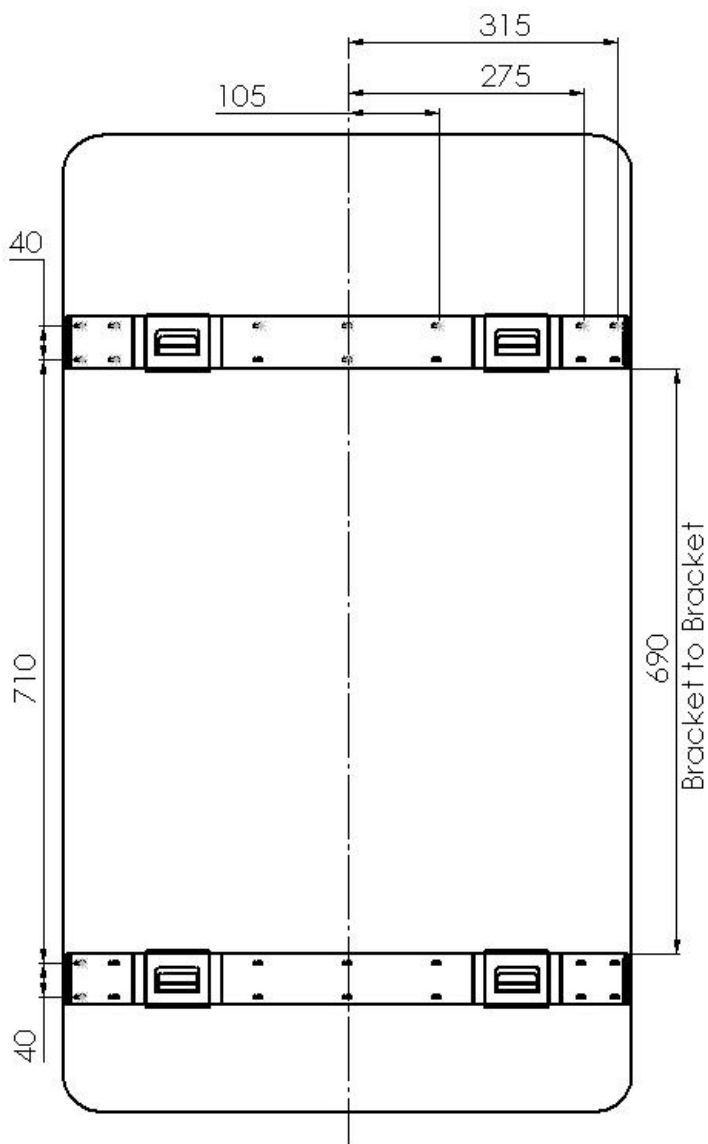

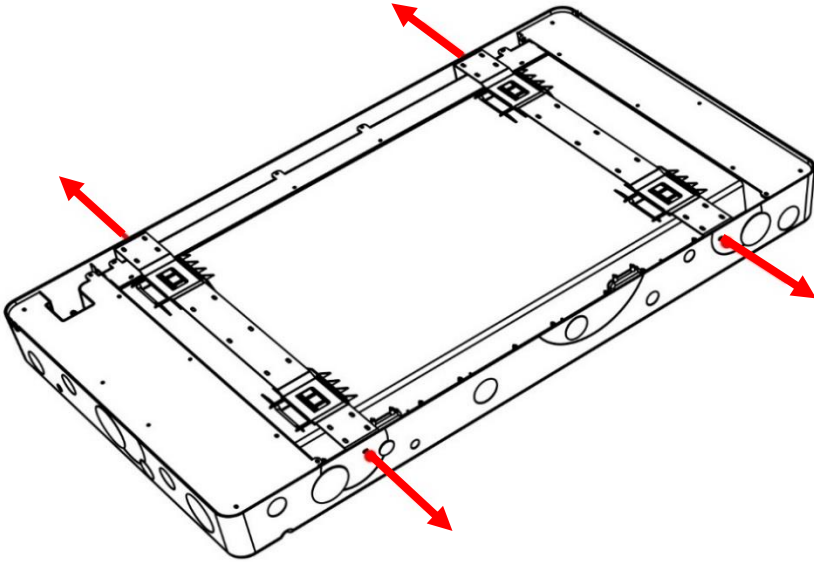

1. Unscrew the 4x M4 screws which secure the 2x brackets to the panels. The brackets are secured to avoid any damage during transit.

Be sure to place the 4x M4 screws in a safe place as they will be required later.

2. Remove the brackets from the panel by sliding the bracket down and then lift them out of panel.

Place the brackets safely to one side as they will be required later.

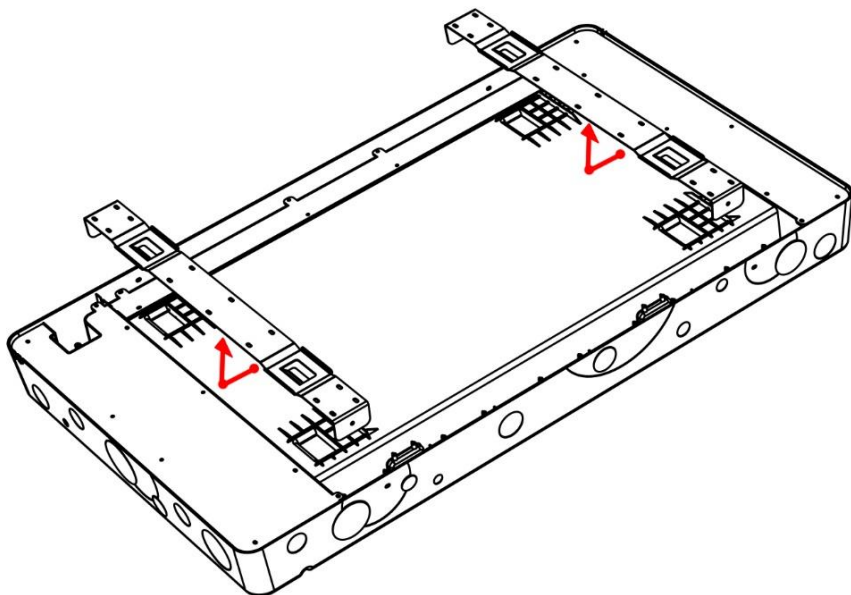

3. Hold the panel where you would like it to be mounted ensuring it is level. Whilst in position mark where the centre of the bracket mounting holes are on the wall. Do this for all 4x bracket mounting holes.

Place the panel safely to the side.

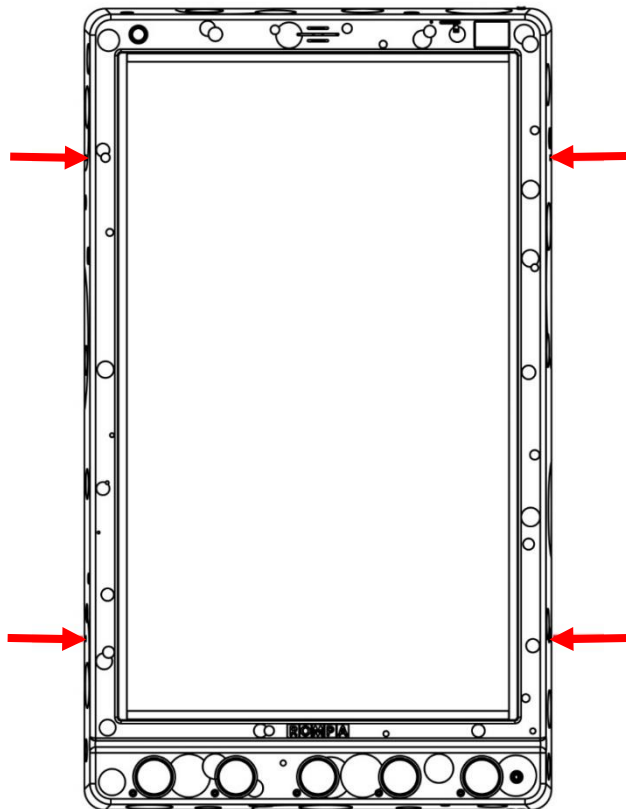

4. Secure both brackets to the wall* ensuring the centre of the bracket mounting holes line up with the marks just made to ensure the bracket is level when mounting it to the wall. The top bracket mounting holes should line up with the top 2x marks and the bottom bracket mounting holes should line up with the bottom 2x marks.

*Fasteners are not supplied and must be purchased separately. Please ensure the correct fasteners are used dependant on the construction of wall in question.

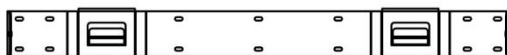
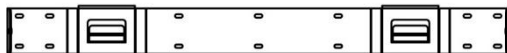

5. Clean the wall and brackets of any dust and debris which may have been created whilst mounting the brackets.

Place the panel on the brackets. To do this have the panel slightly higher than its final resting position. When you feel the panel has slotted into the bracket gradually lower the panel into position.

Reinstall the 4x M4 screws into the mounting bracket holes.

Safety

Installation

- Panel must be installed indoors in a dry environment. Do not install the panel where it may be subject to excessive heat or moisture as this may damage the product or reduce the product's lifespan.
- Ensure any packaging is disposed of correctly. Plastic bags can be a suffocation risk.
- Ensure the panel is mounted by suitably competent or qualified people. Improper mounting could result in injury. Care should be taken to the type of wall you are mounting the panel to and the appropriate fixings which should be used.
- Consider the height at which you are mounting the panel. The age of the primary user and whether they should be seated or standing should dictate the height at which the panel is mounted.

Operation

- **Panel must always be used under supervision.**
- Do not strike the panel. The panel is built robustly but intentional misuse will shorten the product's lifespan.
- Do not open or attempt to repair the panel yourself as this may cause injury and invalidate the warranty.
- Disconnect any cables when installing or moving the product. Pulling of the cables can cause premature wear or damage to the product and/ or accessories.
- If the product generates abnormal sounds, a burning smell or smoke disconnect immediately and contact Rompa® customer services.
- Do not press and hold the panel push buttons for durations of longer than a minute. Over time this may reduce the life expectancy of the product.

Care and Maintenance

To prolong its product life, please read the following instructions when installing and operating this panel:

- When installing please ensure to keep the layer of protective film screen until the whole panel is fully mounted and is ready for use.
- Ensure no sharp tools or objects are near to the screen.
- Rompa® recommends to use a soft microfibre cloth for cleaning and dusting. It optimises the finish and will prevent scratches onto the screen.
- Slightly dampening the cloth or use of isopropyl alcohol is recommended for more stubborn stains. Ensure the panel does not become wet.
- Particular care should be taken around apertures in the chassis and any electronics (touch screen, power button, illuminated push buttons, external switch jacks and microphone input jack).
- Avoid food or drinks near this panel.
- Do not attempt to physically damage the product including the electronics, screen and buttons.
- Ensure loose wires are out of sight.

At the end of the product's life please dispose of the product ethically:

- Product can be taken to local recycling centre. Visit [RecycleNow.com](https://www.recycle-now.com) to find your local recycling centre.
- Some councils offer a household recycling collection service. Contact your local authority for more details.

Troubleshooting

No Sound	Ensure volume is on and turned up to a sufficient level via the touch screen.
	Turn the panel off and wait 10 seconds. Turn the panel back on. This will reset the panel settings and revert the sound to volume 2 and Sound Effects set to on.
	If troubleshooting does not solve the issue please contact Rompa® Customer Services +44 (0) 1246 211 777
Frozen or Unresponsive	Turn the panel off and wait 10 seconds. Turn the panel back on. This will reset the panel and revert the 1 st mode shown on Touch Screen.
	If troubleshooting does not solve the issue please contact Rompa® Customer Services +44 (0) 1246 211 777
Push Button(s) Unresponsive	Ensure panel buttons are not locked via the touch screen.
	Turn the panel off and wait 10 seconds. Turn the panel back on. This will reset the panel settings and revert the panel buttons to unlock.
	If troubleshooting does not solve the issue please contact Rompa® Customer Services +44 (0) 1246 211 777
External Switch Unresponsive	Ensure the switch inlet is clear of any dust or debris.
	Ensure the switch is fully inserted into the inlet.
	Ensure panel buttons are not locked via the touch screen.
	Turn the panel off and wait 10 seconds. Turn the panel back on. This will reset the panel settings and revert the panel buttons to unlock.
	If troubleshooting does not solve the issue please contact Rompa® Customer Services +44 (0) 1246 211 777
No Power	Ensure the mains is off before checking the power cable is fully inserted into the panel and then turn the mains back on.
	Check the power lead's fuse.
	If troubleshooting does not solve the issue please contact Rompa® Customer Services +44 (0) 1246 211 777

For further copies of this manual, please visit www.Rompa.com to access the instruction booklet.