

Tobii Dynavox Speech Case

User's Manual

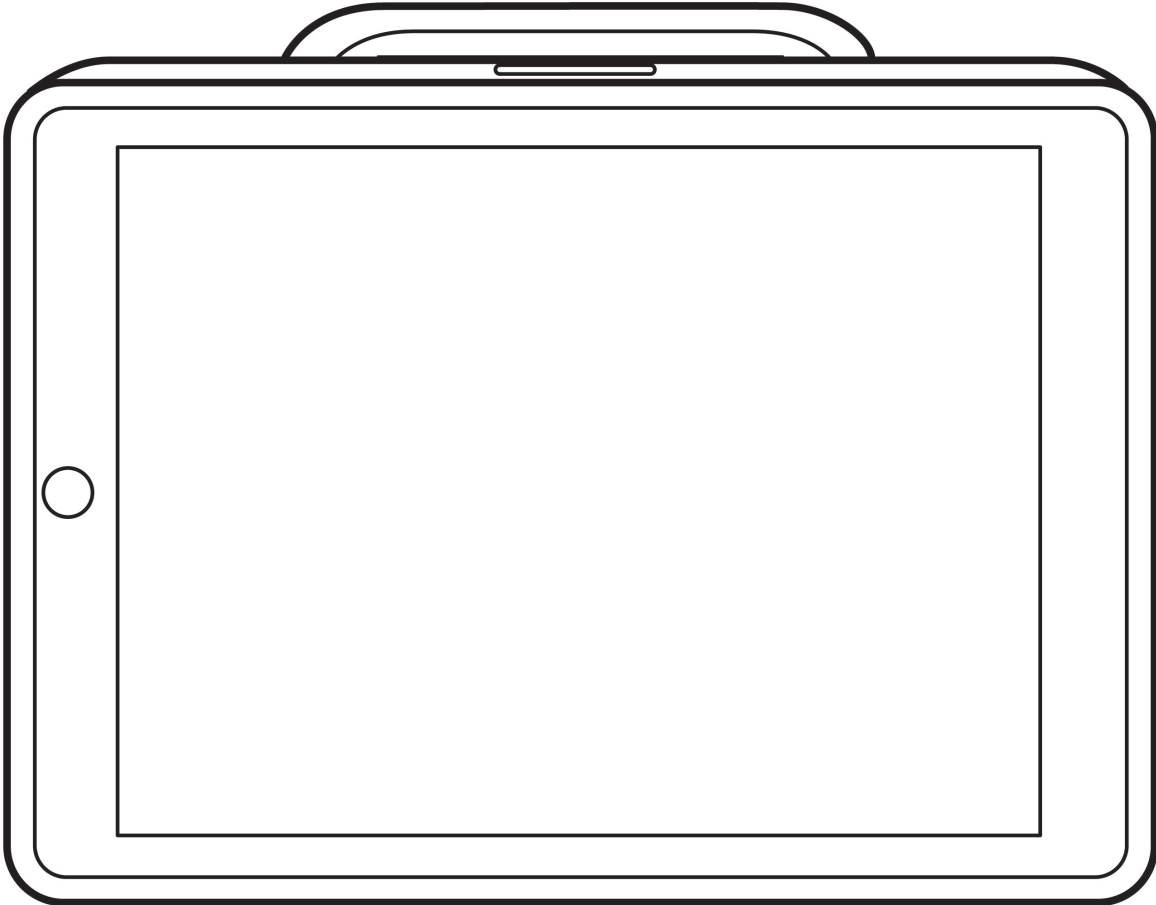

User's manual Tobii Dynavox Speech Case

Version 1.0.2

07/2020

All rights reserved.

Copyright © Tobii AB (publ)

No part of this document may be reproduced, stored in a retrieval system, or transmitted in any form, by any means (electronic, photocopying, recording, or otherwise) without the prior written permission of the publisher.

Copyright protection claimed includes all forms and matters of copyrightable material and information allowed by statutory or judicial law or hereafter granted, including without limitation, material generated from the software programs which are displayed on the screen such as screen displays, menus, etc.

The information contained in this document is proprietary to Tobii Dynavox. Any reproduction in part or whole without prior written authorization by Tobii Dynavox is prohibited.

Products that are referred to in this document may be either trademarks and/or registered trademarks of the respective owners. The publisher and the author make no claim to these trademarks.

While every precaution has been taken in the preparation of this document, the publisher and the author assume no responsibility for errors or omissions, or for damages resulting from the use of information contained in this document or from the use of programs and source code that may accompany it. In no event shall the publisher and the author be liable for any loss of profit or any other commercial damage caused or alleged to have been caused directly or indirectly by this document.

Content subject to change without notice.

Please check Tobii Dynavox web site

www.TobiiDynavox.com for updated versions of this document.

Contact Information:

Tobii Dynavox AB
Karlsrovägen 2D
182 53 Danderyd
Sweden

+46 8 663 69 90

Tobii Dynavox LLC
2100 Wharton Street, Suite 400
Pittsburgh, PA 15203
USA

+1-800-344-1778

- Speech Case Device Identifier: 7340074601738



Table of Contents

1	Introduction	5
1.1	Explanation of Admonitions	5
1.2	Symbols and Markings	5
1.3	Intended Use	6
1.4	Package Contents	6
2	Safety	7
2.1	Avoiding Hearing Damage	7
2.2	Power Supply and Batteries	7
2.3	Temperature	8
2.4	Mounting	8
2.5	Emergency	8
2.6	Electricity	9
2.7	Child Safety	9
2.8	Magnetic Field	9
2.9	Third Party	9
3	Overview of the Speech Case	10
3.1	Key Features	10
3.2	Product Layout	11
3.2.1	Ports and Device Buttons	11
3.3	Access Method Selector	12
3.4	Pre-installed Firmware	13
4	Batteries in the Speech Case	14
4.1	Batteries	14
4.2	Charging the Speech Case	14
4.2.1	Charging Indicator Light (Power LED) Behavior	14
5	Using the Speech Case	15
5.1	Selecting the Correct Access Method Selector Position for the User	15
5.2	Starting the Device	15
5.3	Install the iPad® and Pair through Bluetooth®	16
5.4	Unpair the Bluetooth® Connection	16
5.5	Battery Status and Power Saving	16
5.6	Adjusting the Volume	17
5.7	Adjusting the Sound	17
5.8	Switches	17
6	Product Care	18
6.1	Temperature & Humidity	18
6.1.1	General Use - Operating Temperature	18
6.1.2	Transportation and Storage	18
6.1.3	Charging	18
6.2	Cleaning of the Speech Case Device	18
6.3	Placement	18
6.4	Transporting the Speech Case	18
6.5	Disposing of the Speech Case Device	19
6.6	Disposing of the Batteries	19
Appendix A	Support, Warranty, Training Resources	20
A1	Customer Support	20

A2	Warranty	20
A3	Training Resources	20
Appendix B	Compliance Information	21
B1	FCC Statement	21
	B1.1 For Part 15B Equipment	21
	B1.2 For Portable Devices	21
B2	Industry Canada Statement	21
B3	CE Statement	22
B4	Directives and Standards	22
Appendix C	Technical Specifications	23
C1	Speech Case	23
C2	Power Adapter	23
Appendix D	Approved Accessories	24

1 Introduction

Thank you for purchasing a Speech Case from Tobii Dynavox!

To ensure the optimal performance of this product, please take the time to read this manual carefully.

The Speech Case is a Tobii Dynavox speech accessory intended for use with a 10.2" iPad® (7th generation) as an augmentative communication aid and for computer access for those with speech, language, physical, and cognitive disabilities.

1.1 Explanation of Admonitions

In this manual we use five (5) levels of admonitions as follows:



The Note symbol is used for notifying the user of something important or of something that needs special attention.



The Caution symbol is used to inform of something that could cause harm to, or malfunction of, the equipment.



The Warning symbol is used to inform of something in which there is a conceivable risk of harm to the user if the Warning is ignored.









The High Volume symbol is used to inform of something that can cause damage to hearing.







The High Temperature symbol is used to inform of surface temperature conditions that may cause injury or discomfort.

1.2 Symbols and Markings

This section provides information about the symbols that are used on the Speech Case, its accessories, or packaging.

Symbol or Markings	Description
	Safety Class II double insulated equipment.
	Dispose of in accordance with your country's requirements.
	CE is the abbreviation of the European Communities and this mark tells customs officials in the European Union that the product complies with one or more of the EC Directives.
	This mark is a certification mark employed on electronic products manufactured or sold in the United States which certifies that the electromagnetic interference from the device is under limits approved by the Federal Communications Commission.
	Follow Instructions for Use
	Australian Electrical Equipment Safety System Regulatory Compliance Mark.

Symbol or Markings	Description
	Reduction of Hazardous Substances directive compliant.
+	Volume up.
-	Volume down.
	Manufacturer.
	Reference number.
	Serial Number.

1.3 Intended Use

When used with an appropriately configured iPad, the Tobii Dynavox Speech Case is a speech generating device (SGD) for people who have challenges in their ability to speak due to injury, disability or illness. The Tobii Dynavox Speech Case pairs with the iPad through Bluetooth® to work as an audio output device and switch hub.



CONTRAINDICATION: The Speech Case device does not sustain or support life.

In case of failure of the Speech Case, the user may not be able to communicate using it.



Intended use is primarily an indoor environment.

1.4 Package Contents



It is recommended to keep the original packaging materials for the Speech Case.

If device needs to be returned to Tobii Dynavox for Warranty-related issues or repair, it is beneficial that the original packaging or equivalent is used for shipping. Most shipping carriers require at least 2 inches of packing material around the device.

Note: Due to Joint Commission regulations, any shipping materials including boxes sent to Tobii Dynavox must be discarded.

The items below are included in the Speech Case package:

- 1 Speech Case
- 1 Dual-port USB charger
- 1 USB-to-USB-C power cable
- 1 Carrying strap
- 1 User's Manual Document (printed)
- 1 Getting Start Guide (printed)
- 1 Warranty Document

2 Safety

The Speech Case device has been tested and approved as compliant to all the Specifications and Standards listed in *Appendix B Compliance Information, page 21* of this manual and in the *Appendix C Technical Specifications, page 23*. Nevertheless, in order to ensure safe operation of your Speech Case, there are a few safety warnings to bear in mind:



No modification of this equipment is allowed.



The user may never attempt to change the battery. Altering of the battery may cause risk of explosion.



The Speech Case is not to be used as a life supporting device, and it shall not be relied on in case of loss of function due to power loss or other causes.



There could be a choking hazard risk if small parts detach from the Speech Case device.



The strap and charging cable could present strangulation hazards to young children. Never leave small children unattended with the strap or charging cable.



The Speech Case device shall not be exposed to or used in rain or weather conditions outside the Technical Specification of the Speech Case device.



Young children or people with cognitive disabilities should not have access to, or use, the Speech Case device without parental or guardian supervision.



The Speech Case device shall be used with care when moving around.

2.1 Avoiding Hearing Damage



Permanent hearing loss may occur if earphones, headphones or speakers are used at high volume. To prevent this, the volume should be set to a safe level. You can become desensitized over time to high sound levels which may then sound acceptable yet still could be damaging your hearing. If you experience symptoms such as ringing in your ears, please lower the volume or stop using the earphones/headphones. The louder the volume, the less time is required before your hearing could be affected.

Hearing experts suggest the following measures to protect your hearing:

- Limit the amount of time you use earphones or headphones at high volume.
- Avoid turning up the volume to block out noisy surroundings.
- Turn the volume down if you cannot hear people speaking near you.

To establish a safe volume level:

- Set your volume control at a low setting.
- Slowly increase the sound until you can hear it comfortably and clearly, without distortion.

2.2 Power Supply and Batteries



The power source shall conform to the requirement of the Safety Extra Low Voltage (SELV) standard, and supply power with rated voltage which conforms to Limited power Source requirement according to IEC60950-1.



The Speech Case device contains a rechargeable battery. All rechargeable batteries degrade over time. Thus the possible usage times for the Speech Case after a full charge can become shorter over time than when the device was new.



The Speech Case device uses a Li-ion Polymer battery.

If you are in a hot environment, be aware that it can affect the ability to charge the battery. The internal temperature has to be between 0 °C/32 °F and 45 °C/113 °F for the battery to charge. If the internal battery temperature raises above 45 °C/113 °F, the battery will not charge at all.

Move the Speech Case device to a cooler environment to let the battery charge properly.



Avoid exposing the Speech Case device to fire or to temperatures above 60 °C/140 °F. These conditions may cause the battery to malfunction, generate heat, ignite or explode. Be aware that it is possible, in a worst case scenario, for temperatures to reach greater than those stated above in, for example, the trunk of a car on a hot day. So, storing the Speech Case device, in a hot car trunk could conceivably lead to a malfunction.



Only charge the Speech Case battery in an ambient temperature of 0 °C/32 °F to 45 °C/113 °F.



Use only the supplied power adapter to charge the Speech Case device. Using unauthorized power adapters may severely damage the Speech Case device.



For safe operation of the Speech Case device, use only the charger and accessories approved by Tobii Dynavox.



Do not open, or modify, the casing of the Speech Case device or of the power supply, since you may be exposed to potentially hazardous electrical voltage. The device contains no serviceable parts. If the Speech Case device or its accessories are mechanically damaged, **do not use them**.



If the battery is not charged or the Speech Case is not connected to the power supply, the Speech Case device will shut down.



If the Power Supply Cord is damaged, it needs to be replaced by Service Personnel only. Do not use the Power Supply Cord until replaced.



Disconnect the AC power plug of the Power adapter from the wall socket when not charging the device and disconnect the power cable from the device.



Special regulations apply to shipping devices containing Li-ion Polymer batteries. If dropped, crushed, or short-circuited, these batteries can release dangerous amounts of heat, may ignite, and may be dangerous in fires.

Please reference IATA regulations when shipping lithium metal or lithium ion batteries or cells: http://www.iata.org/whatwedo/cargo/dangerous_goods/Pages/lithium_batteries.aspx



The Power adapter shall not be used without an adult or caregiver supervision.

2.3 Temperature



Due to use in direct sunshine or in any other hot environment, the Speech Case device may have hot surfaces.

2.4 Mounting



The Speech Case should be mounted according to MANUFACTURER instructions of approved mounts. Tobii Dynavox or its agents are not liable for damage or injuries to a person or its property due to a Speech Case falling from a mounted configuration. The mounting of a Speech Case is done entirely at the user's own risk.

2.5 Emergency



Do not rely on the Speech Case device for emergency calls. We recommend having multiple ways to communicate in emergency situations.

2.6 Electricity



Do not open the casing of the Speech Case device, since you may be exposed to potentially hazardous electrical voltage. The device contains no user serviceable parts.

2.7 Child Safety



The Speech Case is an advanced computer systems and electronic device. As such they are composed of numerous separate, assembled parts. In the hands of a child certain of these parts have the possibility of being separated from the device, possibly constituting a choking hazard or another danger to the child.

Young children should not have access to, or the use of, the device without parental or guardian supervision.

2.8 Magnetic Field



The Speech Case device contains magnets. Magnetic fields may interfere with pacemakers, defibrillators, or other medical devices. As a general rule, maintain a minimum distance of 6 inches (15 centimeters) between any item with magnets and your heart device.

If you suspect that the Speech Case device is interfering with your pacemaker or any other medical device, stop using the Speech Case device and consult your physician for specific information about that affected medical device.

2.9 Third Party



Any use of the Speech Case outside the intended use and together with any third party software or hardware that changes the intended use is a risk and nothing that Tobii Dynavox can take any responsibility for.

3 Overview of the Speech Case

3.1 Key Features

The Speech Case has several built-in features.

- 2 × internal speakers
- 2 × switch ports
- 1 × power/access method selector
- 1 × Bluetooth® radio
- 1 × charging port

3.2 Product Layout

3.2.1 Ports and Device Buttons

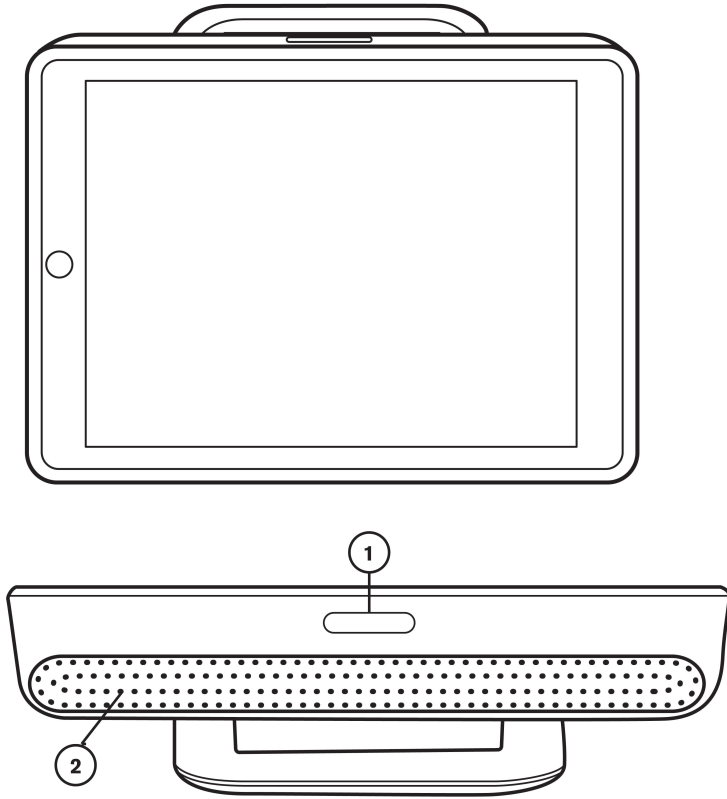

Figure 3.1 Front and Top View

Position	Description
1	Volume rocker switch
2	Speakers

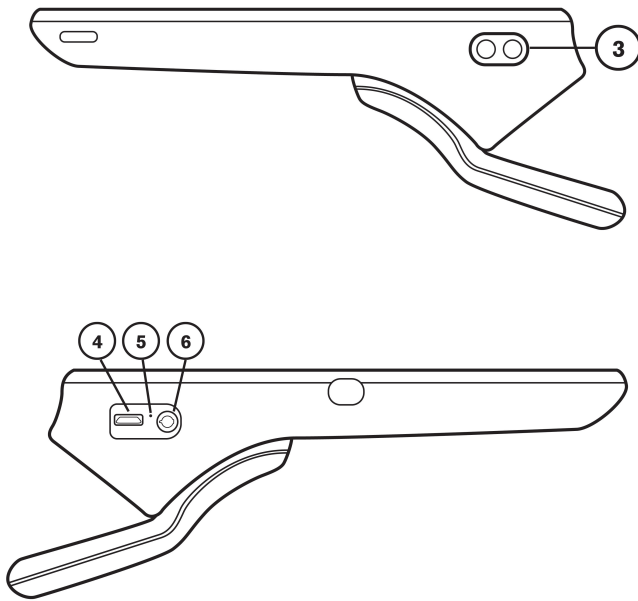

Figure 3.2 Side Views

Position	Description
3	Switch ports (2)
4	Charging port
5	Charging indicator light (Power LED)
6	Access method selector



Never force a connector into a port. If the connector and port do not join with reasonable ease, they probably do not match. Make sure that the connector matches the port and that you have positioned the connector correctly in relation to the port.

3.3 Access Method Selector

The Access method selector has three (3) different positions:

Position	Description
S	<p>iOS Scanning mode — for use with the iOS native switch scanning access method. Choose this mode if you would like to use iOS scanning to navigate all apps and folders.</p> <p>Set to S for iOS scanning.</p> <ul style="list-style-type: none"> ● Access all apps and files using scanning. ● Not compatible with certain Snap Core First scanning features. ● Configure scanning options in iOS Accessibility Settings. ● To use iOS scanning in Snap, set the access method in Snap to Touch.
0	<p>Shipping mode — turns off the Bluetooth® radio.</p>
T	<p>Touch mode — to use touch to navigate apps and to use any Tobii Dynavox access method (including scanning) within Tobii Dynavox apps.</p> <p>Set to T for Snap Scanning and other Tobii Dynavox access methods.</p> <ul style="list-style-type: none"> ● Best for users new to scanning. ● Customize with Snap scanning features such as Group Scanning, Auditory Cues, and Hold Time. ● Scanning is limited to Snap and other Tobii Dynavox accessible apps. Items outside of Tobii Dynavox accessible apps cannot be scanned. ● Most efficient scanning in Snap and other accessible apps.

3.4 Pre-installed Firmware

The Speech Case is delivered with all required firmware installed and ready to use.

4 Batteries in the Speech Case

4.1 Batteries

The Speech Case has one built-in battery. If the Speech Case battery is not charged sufficiently, the Speech Case will shut down automatically.



When the Speech Case shuts down due to loss of battery charge, the Bluetooth® pairing is lost. When the Speech Case is powered on again, re-establish Bluetooth® pairing as described in section 5.3 *Install the iPad® and Pair through Bluetooth®*.

4.2 Charging the Speech Case

1. Connect the Power cable to the charging port on the Speech Case and to the Power adapter.
2. Connect the Power adapter to an electrical outlet.
3. Charge the Speech Case until the battery is fully charged.
4. After the Speech Case is fully charged, disconnect the charger from both the device and the electrical outlet.



You **can't** overcharge the battery. It is fine to charge the battery overnight.

You **can** use the Speech Case while the battery is charging.



Because of internal chemical reactions, battery performance may deteriorate over time. In addition, failure to keep the conditions of use (charge, discharge, ambient temperature, etc.) within specified ranges may shorten the battery life expectancy, or damage your Speech Case device. If the battery cannot maintain a charge for long periods of time, even when it is charged correctly, it may need to be replaced.

The battery may need to be replaced every 12 to 18 months with typical use. Don't try to replace the battery yourself. The battery is internal and is not intended for service or replacement by the user or anyone other than a Tobii Dynavox technician.

For battery storage and charging temperatures, see 2.2 *Power Supply and Batteries*, page 7.

4.2.1 Charging Indicator Light (Power LED) Behavior

The Charging indicator light (Power LED) (Position 5 in *Figure 3.2 Side Views*) will shine when the power adapter is plugged in and the battery is charging:

- Steady light on — Charging
- Flashing light — Battery fault (unit may need to be serviced)
- Light off — Unit is fully charged

5 Using the Speech Case

5.1 Selecting the Correct Access Method Selector Position for the User

How will the user select the items on the device?		
Touch Screen	Switch Scanning	
	iOS Scanning	Snap Scanning
<ul style="list-style-type: none"> • Select directly with Touch on the Touch Screen • Select with Tobii Dynavox Touch Access Methods: Touch, Touch Enter and Touch Exit • Select with switches and Tobii Dynavox Scanning 	<ul style="list-style-type: none"> • Access all apps and files using scanning. • Not compatible with certain Snap Core First scanning features. • Configure scanning options in iOS Accessibility Settings. • To use iOS scanning in Snap, set the access method in Snap to Touch. 	<ul style="list-style-type: none"> • Best for users new to scanning. • Customize with Snap scanning features such as Group Scanning, Auditory Cues, and Hold Time. • Scanning is limited to Snap and other accessible apps. Items outside of accessible apps cannot be scanned. • Most efficient scanning in Snap and other accessible apps.
Set to "T"	Set to "S"	Set to "T"

5.2 Starting the Device

The Speech Case has four modes:

- **Touch mode** — to use touch to navigate apps and folders and to use any Tobii Dynavox access method (including scanning) within Tobii Dynavox apps.
- **iOS scanning mode** — for use with the iOS native switch scanning access method. Choose this mode if you would like to use iOS scanning to navigate all apps and folders.
- **Shipping mode** — turns off the Bluetooth® radio.
- **Firmware upgrade mode** — use only if the user is directed to update the Speech Case firmware.

To start the Speech Case in Touch (T) mode



If you have paired this Speech Case with this iPad previously, see [5.4 Unpair the Bluetooth® Connection, page 16](#).

When the Access Method Selector is moved from Off to Touch (T), the unit will say "Power On" and after a few seconds, one (1) click will be heard.

1. Ensure that nothing is connected to the switch ports on the Speech Case.
2. Make sure the Access Method Selector is in position **T**.
3. Follow the instructions in [5.3 Install the iPad® and Pair through Bluetooth®, page 16](#)

To start the Speech Case in iOS scanning (S) mode



If you have paired this Speech Case with this iPad previously, see [5.4 Unpair the Bluetooth® Connection, page 16](#).

When the Access Method Selector is moved from Off to Scan (S), the unit will say "Power On" and after a few seconds, two (2) clicks will be heard.

1. Ensure that nothing is connected to the switch ports on the Speech Case.
2. Make sure the Access Method Selector is in position **S**.
3. Follow the instructions in [5.3 Install the iPad® and Pair through Bluetooth®, page 16](#)

To put the Speech Case in Shipping mode (Device will be turned OFF)



If you have paired this Speech Case with this iPad previously, see [5.4 Unpair the Bluetooth® Connection](#), page 16.

1. Ensure that nothing is connected to the switch ports on the Speech Case.
2. Make sure the Access Method Selector is in position **O**.

To put the Speech Case in Firmware Upgrade mode

1. Press and hold the **Volume +** button while moving the **Access Method Selector** from **O** to either **T** (touch) or **S** (scan) mode.



The Speech Case is designed to remain powered on in either Touch (T) mode or iOS scanning (S) mode.

5.3 Install the iPad® and Pair through Bluetooth®

1. Follow the steps in the Tobii Dynavox Speech Case Getting Started Guide to properly install the iPad.
2. On your iPad device, go to **Settings > Bluetooth** and turn on Bluetooth®. Stay on this screen until you complete the remaining steps to pair your Speech Case.
3. Make sure that the Speech Case is in the **S** or **T** mode as described in [5.2 Starting the Device](#).
4. Select the Speech Case in the My Devices or Other Devices list of the iPad's Bluetooth® menu. The Speech Case is now paired and ready to use.



The Speech Case Bluetooth® ID ends with the same last 5 digits as the Speech Case case serial number. The word "Touch" or "Scan" in the Bluetooth® ID indicates the current mode of the device. The Speech Case serial number may be found on the label on the inside of the stand.

5.4 Unpair the Bluetooth® Connection

If you have paired this Speech Case with this iPad previously, you must first "forget" the Speech Case in the Bluetooth® device list.

1. Go to **Settings > Bluetooth**.
2. Find the Speech Case in the list.
3. Select the "i" icon next to it.
4. Select **"Forget this Device."**
5. Confirm by selecting **"Forget Device."**

5.5 Battery Status and Power Saving

The Speech Case battery status is monitored through your paired iPad®. Follow the steps below to show the Batteries widget on your Today screen.

Add the Battery Status widget

1. On your iPad, swipe right over the Home screen to get to the Today screen.
2. Scroll to the bottom and tap **Edit**.
3. Locate **Batteries** in the list of widgets and tap **+** to add it to your Today screen.
4. Select **Done**.

You can now swipe right over the Home screen at any point to get to the Today screen and view the battery status of the Speech Case (the Speech Case must be paired).

The widget also shows the iPad's charge



The Speech Case battery displays in 10% status increments. When the battery reaches 10%, the Speech Case should be connected to a power source, otherwise it will power off soon.

The Power saving settings in the Speech Case are preset to optimize the battery run-time. The Speech Case is designed to remain powered on.

5.6 Adjusting the Volume

To adjust the volume, use the Volume Up and Down rocker (Position 1 in *Figure 3.1 Front and Top View*) on the top of the Speech Case.



Volume adjustments can be done in the Snap software or iOS software on the iPad.

5.7 Adjusting the Sound

You can configure the speakers using the **iOS Settings > Music > EQ**.



The Speech Case includes a hole to allow use of the iPad internal microphone for audio input. In some circumstances, the case can cause interference with audio input. To achieve the best audio input quality, try temporarily removing the iPad from the case or using an external microphone plugged into the iPad lightning port.

5.8 Switches

When the Speech Case is in touch mode, switches send the following for Tobii Dynavox scanning:

- Switch 1 — Space key
- Switch 2 — Enter key



When the Speech Case is in touch mode, set the Access Method in your Tobii Dynavox apps to Scanning, and set the Switch 1 to Space key and Switch 2 to Enter key.

When the Speech Case is in iOS scanning mode, switches send the following by default:

- Switch 1 — Move to next item
- Switch 2 — Select



When the Speech Case is in iOS scanning mode and paired to the iPad by Bluetooth®, iOS Switch Control is turned on automatically and 2 Switches are created for 2-Switch Step Scan (if no iOS Switches already exist). Set the Access Method in your Tobii Dynavox apps to Touch. For Autoscan, change the switches in iOS Switches to only 1 switch, with the Action “Select.”

For other switch options, consult your iOS user’s manual Switch Control section or your Tobii Dynavox app user’s manual.

6 Product Care

6.1 Temperature & Humidity

6.1.1 General Use - Operating Temperature

The Speech Case is best kept in dry conditions at room temperature. The recommended range for temperature and the humidity value for the device is as follows:

- Ambient temperature: 0°C to 35°C (32°F to 95°F)
- Relative humidity: 10% to 90% (no condensation on the device)

6.1.2 Transportation and Storage

For transportation and storage the recommended range for temperature and the humidity value for the device is as follows:

- Temperature: -30°C to 70°C (-22°F to 158°F)
- Humidity: 10% to 95% (no condensation on the device)
- Atmospheric Pressure: 70 kPa to 106 kPa (375 mmHg to 795 mmHg)

The Speech Case is not waterproof or water resistant. The device should not be kept in excessively humid, damp or otherwise wet conditions. Do not submerge the device in water or in any other liquid. Be careful not to allow liquids to be spilled upon the device, especially in the connector areas.

6.1.3 Charging

For charging, the recommended range for temperature and the humidity value for the device is as follows:

- Temperature: 10°C to 45°C (50°F to 113°F)
- Relative humidity: 5% to 90% (no condensation on the device)

6.2 Cleaning of the Speech Case Device

1. Before cleaning, fully shut down your device.
2. Unplug your device.
3. Remove all cables.
4. Wipe over all external surfaces using hospital grade cleaning wipes or equivalent disinfectant wipe for infection control.
5. Allow the device to dry naturally.
6. Any accessories included must also be disinfected in the same way.
7. If streaky residue remains from cleaning, buff screen with a soft dry cloth.
8. Dispose of used cleaning materials properly.



Do not use spray products directly on to the device as these may saturate the device and allow unwanted moisture into the unit.

6.3 Placement

Only use the recommended mounts specified by the your local reseller or sales representative and make sure that they are mounted and fastened correctly according to the instructions. Do not place the device on unstable and/or uneven surfaces.

6.4 Transporting the Speech Case

Disconnect all the cables from the Speech Case while carrying the device.



It is recommended to keep the original packaging materials for the Speech Case.

If device needs to be returned to Tobii Dynavox for Warranty-related issues or repair, it is beneficial that the original packaging or equivalent is used for shipping. Most shipping carriers require at least 2 inches of packing material around the device.

Note: Due to Joint Commission regulations, any shipping materials including boxes sent to Tobii Dynavox must be discarded.

6.5 Disposing of the Speech Case Device

Do not dispose of the Speech Case device in general household or office waste. Follow your local regulations for the disposal of electrical and electronic equipment.

6.6 Disposing of the Batteries

Do not dispose of the batteries in general household or office waste. Follow your local regulations for the disposal of batteries.

Appendix A Support, Warranty, Training Resources

A1 Customer Support

For support, please contact your local representative or Support at Tobii Dynavox. In order to receive assistance as quickly as possible, make sure you have access to your Speech Case device and, if possible, an Internet connection. You should also be able to supply the serial number of the device, which you find on the back of the device.

For further product information and other support resources, please visit the Tobii Dynavox website www.tobiidynavox.com.

A2 Warranty

Please read the Manufacturer's Warranty paper included in the package.



Tobii Dynavox does not warrant that the Software on the Speech Case will meet Your requirements, that the operation of the Software will be uninterrupted or error-free, or that all Software errors will be corrected.



Tobii Dynavox does not warrant that the Speech Case will meet Customer requirements, that the operation of the Speech Case will be uninterrupted, or that the Speech Case is free from bugs or other defects. Customer acknowledges that the Speech Case will not function for all individuals and in all light conditions.

Please read this User's Manual carefully before using the device. The warranty is only valid if the device is used according to the User's Manual. Disassembling the Speech Case device will void the warranty.



It is recommended to keep the original packaging materials for the Speech Case.

If device needs to be returned to Tobii Dynavox for Warranty-related issues or repair, it is beneficial that the original packaging or equivalent is used for shipping. Most shipping carriers require at least 2 inches of packing material around the device.

Note: Due to Joint Commission regulations, any shipping materials including boxes sent to Tobii Dynavox must be discarded.

A3 Training Resources

Tobii Dynavox offer a range of training resources for the Speech Case products and related communication products. You can find them on www.tobiidynavox.com

Appendix B Compliance Information



The Speech Case is CE-marked, indicating compliance with the essential health and safety requirements set out in European Directives.

B1 FCC Statement

This device contains FCC ID: 5123A-BGTWT32AE and complies with Part 15 of the FCC Rules. Operation is subject to the following two conditions: (1) this device may not cause harmful interference and (2) this device must accept any interference received, including interference that may cause undesired operation.



Modifications not expressly approved by Tobii Dynavox could void the user's authority to operate the equipment under FCC rules.

B1.1 For Part 15B Equipment

This equipment has been tested and found to comply with the limits for a Class B digital device, pursuant to part 15 of the FCC rules. These limits are designed to provide reasonable protection against harmful interference in a residential installation. This equipment generates, uses and can radiate radio frequency energy and, if not installed and used in accordance with the instructions, may cause harmful interference to radio communications.

However, there is no guarantee that interference will not occur in a particular installation. If this equipment does cause harmful interference to radio or television reception, which can be determined by turning the equipment off and on, the user is encouraged to try to correct the interference by one or more of the following measures:

- Reorient or relocate the receiving antenna.
- Increase the separation between the equipment and receiver.
- Connect the equipment into an outlet on a circuit different from that to which the receiver is connected.
- Consult the dealer or an experienced radio/TV technician for help.

B1.2 For Portable Devices

FCC RF Radiation Exposure Statement:

1. This Transmitter must not be co-located or operating in conjunction with any other antenna or transmitter.
2. This equipment complies with FCC RF radiation exposure limits set forth for an uncontrolled environment. This device was tested for typical hand held operations with the device contacted directly to the human body to the sides of the device. To maintain compliance with FCC RF exposure compliance requirements, avoid direct contact to the transmitting antenna during transmitting.

B2 Industry Canada Statement

Caution

- (i) The device for operation in the band 5150-5250 MHz is only for indoor use to reduce the potential for harmful interference to co-channel mobile satellite systems;
- (ii) The maximum antenna gain permitted for devices in the bands 5250-5350 MHz and 5470-5725 MHz shall be such that the equipment still complies with the e.i.r.p. limit;
- (iii) The maximum antenna gain permitted for devices in the band 5725-5850 MHz shall be such that the equipment still complies with the e.i.r.p. limits specified for point-to-point and non-point-to-point operation as appropriate; and
- (iv) Users should also be advised that high-power radars are allocated as primary users (i.e. priority users) of the bands 5250-5350 MHz and 5650-5850 MHz and that these radars could cause interference and/or damage to LE-LAN devices.

Avertissement

- (i) les dispositifs fonctionnant dans la bande 5150-5250 MHz sont réservés uniquement pour une utilisation à l'intérieur afin de réduire les risques de brouillage préjudiciable aux systèmes de satellites mobiles utilisant les mêmes canaux;
- (ii) le gain maximal d'antenne permis pour les dispositifs utilisant les bandes de 5250 à 5350 MHz et de 5470 à 5725 MHz doit être conforme à la limite de la p.i.r.e.;

(iii) le gain maximal d'antenne permis (pour les dispositifs utilisant la bande de 5725 à 5850 MHz) doit être conforme à la limite de la p.i.r.e. spécifiée pour l'exploitation point à point et l'exploitation non point à point, selon le cas;
(iv) De plus, les utilisateurs devraient aussi être avisés que les utilisateurs de radars de haute puissance sont désignés utilisateurs principaux (c.-à-d., qu'ils ont la priorité) pour les bandes 5250-5350 MHz et 5650-5850 MHz et que ces radars pourraient causer du brouillage et/ou des dommages aux dispositifs LANEL.

This device contains IC ID: 5132A-BGTWT32AE and has been tested to the safety requirements for exposure to radio waves (SAR) in RSS-102 to the General Public (Uncontrolled Environment) limits (1.6W/Kg). The highest SAR value for the Speech Case device is 0.3 W/kg. This device can be operated safely with a minimum distance 0 cm between the equipment and the user's body.

Ce dispositif contient IC ID: 5132A-BGTWT32AE a été testé aux exigences de sécurité pour l'exposition aux ondes radio (SAR) dans le CNR-102 à le grand public (environnement non contrôlé) des limites (1.6W/Kg). La valeur maximale mesurée de SAR pour le Speech Case dispositif est: 0.3 W/kg. Ce dispositif peut être exploité en toute sécurité avec un 0cm distance minimale entre le matériel et les corps de l'utilisateur.

This Class B digital apparatus complies with Canadian ICES-003.

Cet appareil numérique de la classe B est conforme à la norme NMB—003 du Canada.

This device complies with Industry Canada license-exempt RSS standard(s). Operation is subject to the following two conditions: (1) this device may not cause interference, and (2) this device must accept any interference, including interference that may cause undesired operation of the device.

Le présent appareil est conforme aux CNR d'Industrie Canada applicables aux appareils radio exempts de licence. L'exploitation est autorisée aux deux conditions suivantes: (1) l'appareil ne doit pas produire de brouillage, et (2) l'utilisateur de l'appareil doit accepter tout brouillage radioélectrique subi, même si le brouillage est susceptible d'en compromettre le fonctionnement.

B3 CE Statement

This equipment complies with the requirements relating to electromagnetic compatibility, the essential protection requirement of Electromagnetic Compatibility (EMC) Directive 2014/30/EU on the approximation of the laws of the Member States relating to electromagnetic compatibility and Radio Equipment Directive (RED) 2014/53/EU to meet the regulation of the radio equipment and telecommunications terminal equipment.

B4 Directives and Standards

The Speech Case complies with the following directives:

- Low voltage Directive 2014/35/EU
- Electromagnetic Compatibility (EMC) Directive 2014/30/EU
- Radio Equipment Directive (RED) 2014/53/EU
- RoHS2 Directive 2011/65/EU
- WEEE Directive 2012/19/EU
- Reach Directive 2006/121/EC, 1907/2006/EC Annex 17
- Batteries Directive 2013/56/EU

The device has been tested to comply with EN 62368-1, ISO 14971:2007 and EN ISO 14971:2012 and other relevant standards for the intended markets.

Appendix C Technical Specifications

C1 Speech Case

Standard	Speech Case
Type	Speech accessory for 10.2" iPad (7th generation)
Model	Speech Case
Dimensions (WxHxD)	273 × 196 × 52 mm 10.7 × 7.7 × 2.0 inches
Weight	624 g 1 lb 6 oz
Speakers	2 × 31 mm × 9 mm, 4.0 ohms, 5 W
Connectors	2 × 3.5 mm Switch Jack Ports 1 × USB-C
Buttons	1 × Volume Up 1 × Volume Down 1 × 3 Position Selector
Bluetooth®	Bluetooth® 3.0
Battery Run Time	~ 8 hours. normal usage
Battery Technology	Li-ion Polymer rechargeable battery
Battery Capacity	15.54 Wh
Battery Charge Time	~ 4 hours
Power Supply	5.0 VDC 4.8A AC adapter

C2 Power Adapter

Item	Specification
Model	SPAD92BC-20
Input voltage	100 to 240 VAC
Input current (max)	0.48 A
Input frequency	50 to 60 Hz
Output current	4.8A
Rated output voltage	5 VDC

Appendix D Approved Accessories

For information about the latest approved accessories for the Speech Case, please visit www.TobiiDynavox.com or contact your local Tobii Dynavox reseller.

Support for Your Tobii Dynavox Device

Get Help Online

See the product-specific Support page for your Tobii Dynavox device. It contains up-to-date information about issues and tips & tricks related to the product. Find our Support pages online at: www.TobiiDynavox.com/support-training

Contact Your Solution Consultant or Reseller

For questions or problems with your product, contact your Tobii Dynavox solution consultant or authorized reseller for assistance. They are most familiar with your personal setup and can best help you with tips and product training. For contact details, visit www.TobiiDynavox.com/contact