

RGK Head Office: Units 8 A/C Ring Road, Zone 2, Burntwood Business Park, Burntwood, Staffordshire, WS7 3JQ, UK
 Telephone:+44 (0) 1543 670077 - Fax:+44(0)1543 670088 - info@rgkwheelchairs.com - www.rgkwheelchairs.com
 To place order: chairorders@rgkwheelchairs.com
 To request quotation: quotes@rgkwheelchairs.com



Distributor Name: _____
 Contact Name: _____

Purchase Order No: _____
 Delivery Address: _____

 Postcode: _____
 Contact Name: _____
 Telephone: _____
 Email: _____

Notes/Comments:

FOR RGK OFFICE USE ONLY

A/C No: _____		
	Who	Date
OK to Quote:		
OK to Confirm:		
Document No:	DOC	

Net Value: £ _____
 Freight: £ _____
 Invoice Value: £ _____
 Payment Received: £ _____

- Base product
- Standard configuration
- Mandatory information
- Option with no extra cost
- Information required for option
- Option with extra cost

SBAXZ010 TIGA SUB4

XA070 Open design

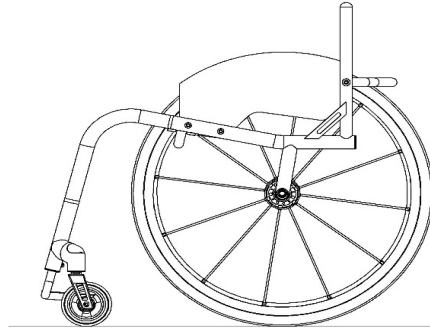

Max User Weight 110kg

- XW010 Full CAD drawing for approval
- XW011 Quick CAD drawing for approval
(Basic outline of chair within 2 working days*) *Approximate time only

KEY FRAME MEASUREMENTS

- XY010 Seat width (*Inside of sideguards*)
 - (Max - 440mm)
(Min - 250mm)
- XY020 Seat length
 - (Max - 440mm)
(Min - 250mm)
- XY030 Extra seat length (*Provides additional leg support & hand grip*)
 - (Max - 440mm total seat)
- XY050 Front frame height
 - (Max - 520mm)
(Min - 380mm)
- XY060 Rear frame height
 - (Max - 500mm)
(Min - 360mm)
- XY070 Frame length
 - (Min = XY020 + XY030 + 140mm)
(Max - 625mm)
- XY072 Castor position
 -
 - Optimise measurements
- XA020 Ergonomic seat
 - Specify length (Standard = 120mm)

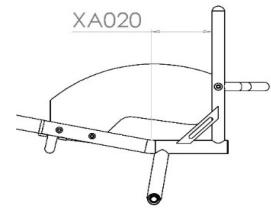
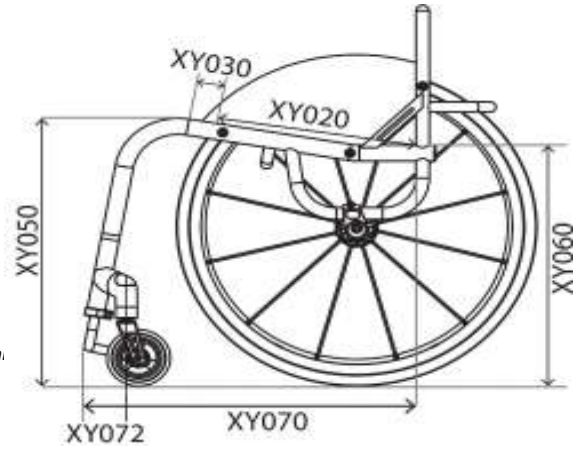
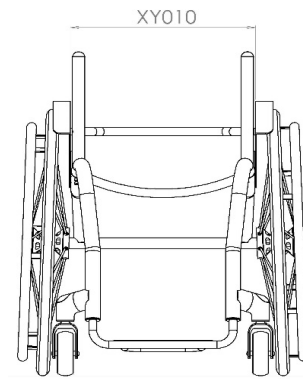

FRONT FRAME AND FOOTREST

Front Frame Options

XY080 Seat taper design

i Specify width mm

(When combined with **XY091**, dimension is inbetween the centre of the main bends)

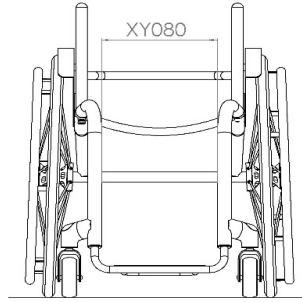

XY091 Parallel taper design

i Specify width mm

(When combined with XY080, dimensions must be smaller by 20mm)

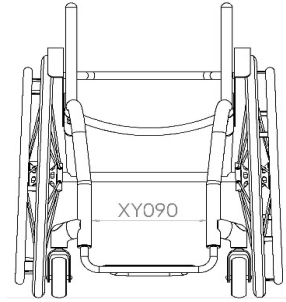

Footrest Design & Measurements (Choose One)

XY100 Round design

Castor Wheel Size	Max Height Achievable
4"	110mm

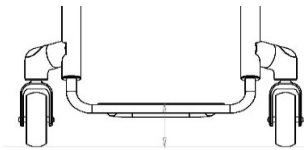

XY105 Square design

Castor Wheel Size	Max Height Achievable
4"	130mm

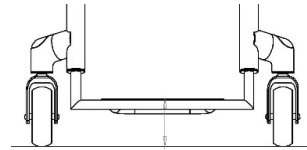

Footrest Individual Measurements

XY115 Front footrest height

! mm

XY120 Rear footrest height

i mm

(Std = 20 lower than front height)

XY125 Footrest length

i mm

Maximum length 140mm

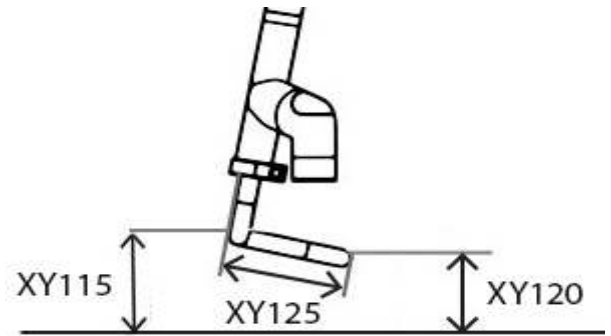

Footrest Style

XB010 Tubular aluminium footrest (Height adjustable)

Footrest Cover

XB045 Lightweight carbon fibre cover (With weight saving cut-out)

CASTOR WHEELS, FORKS & WHEEL LOCKS

Castor Wheels

- XC135 Frog legs aluminium centre 4"x1.25"
Choose colour below:



- | | |
|--|---|
| <input type="checkbox"/> Silver hub & black tyre (Std) | <input type="checkbox"/> Green hub & black tyre |
| <input type="checkbox"/> Black hub & black tyre | <input type="checkbox"/> Red hub & black tyre |
| <input type="checkbox"/> Purple hub & black tyre | <input type="checkbox"/> Blue hub & black tyre |

- SBAXC137 Frog Legs carbon composite centre 4"x1.25"
(Black hub & black urethane tyre)

Castor Forks

- XC190 Low ride castor fork
Note: Colour follows accent

Castor Pin Width

- XY330 Castor pin width
- Optimise measurements
(Minimum width for clear castor rotation and maximum wheelbase length)

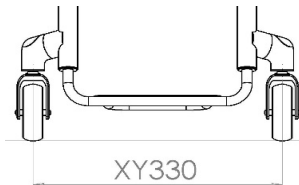

Wheel Lock Options

- | | |
|---|---|
| <input type="checkbox"/> SBAXD036 Compact scissor with lightweight fixing | <input type="checkbox"/> XD010 Omit wheel locks |
|---|---|

SIDEGUARDS

Sideguard

Carbon Fibre Options

- XE055 Screw on lightweight carbon fibre

Sideguard Measurements

- Individual above tyre (Follow tyre - max. 25mm)

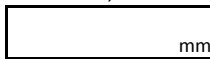

- Level with tyre (Follow tyre)

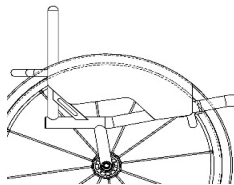

Sideguard with Fender

Carbon Fibre Options

- XE065 Screw on lightweight carbon fibre with fender

Sideguard Measurements

- 10mm above tyre (Standard)

- Individual above tyre (Min = 10mm)

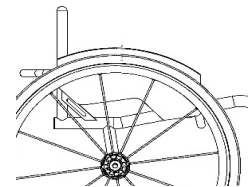
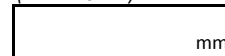

- Centre of tyre

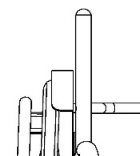

BACKREST

Backrest Height - Fixed

Backrest Design - Fixed

XY230 Backrest height fixed

Specify height

mm

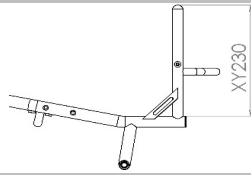

XG010 Fixed backrest (Non-folding)

Ergonomics - Rearward Positioning (Choose One)

XY360 Backrest angle

-5 -3 0 +3 +5

Individual Deg
(Max -10/+20 Deg)

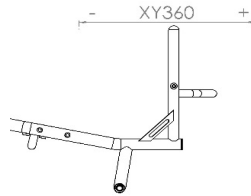

XG100 Ergonomic backrest

Vertical height

mm

Rearward position

mm

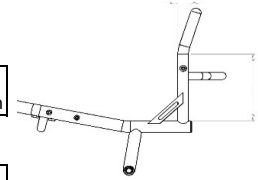

Ergonomics - Lateral Positioning (Choose One)

XG110 Inward taper (inside of backrest posts)

Specify width or per side

mm

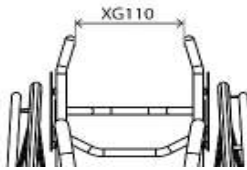

XG120 Outward flare (inside of backrest posts)

Specify width or per side

mm

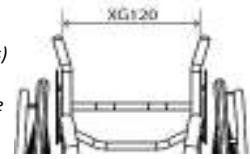

CAMBER BAR

Specify Camber Angle

Fixed Centre of Gravity

XY390 Camber angle

1 2 3

SBAXH100 Single post fixed centre of gravity (25-125mm)

mm

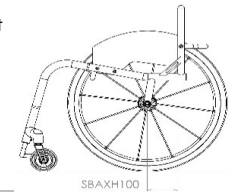

FRAME FINISH OPTIONS

Frame and Footrest

SBAXN030 Brushed frame

SBAXN050 Polished frame

Accent Colour (Choose One)

Note: Accent colour includes, forks & castor caps.

Black accent

Red accent

Purple accent

Silver accent

Blue accent

Carbon accent
(Castor caps only, black for rest)

UPHOLSTERY

Seat Upholstery

XP045 Seat sling Sub4 adjustable tension

Backrest Upholstery

XP035 Airtech Sub4 backrest strap adjustable

Backrest Upholstery Stitching Options

Silver
(Standard if not indicated)

Red

Black

Light blue

Blue

Purple

Other Upholstery

XS065 Sub4 Calf Strap

REAR WHEELS (* non certified weight options)

Wheel Size

-  XY420 24" Wheels
 XY430 25" Wheels

Wheel Gap

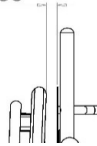
- XY460 Rear wheel gap
- 
 15
 20
 25
- 

Wheel Options

- XK075 Spinerger **BLXL** 18 blade spoke (*select colour below - Note: Black hub only*)
 SBAXK150 Spinerger **CLX** 18 carbon blade spoke
- XK226 Titanium 100mm quick release axle pins

Spinerger Colour Options:

-  Black / Black hub
 White / Black hub
 XK180 Custom spoke design (*Specify colour*)
- Red / Black hub
 Blue / Black hub
 Inside: _____
- Yellow / Black hub
 Green / Black hub
 Outside: _____
- Pink / Black hub
 Orange / Black hub
- Purple / Black hub

Custom Anodise Options

- XK201 Red hub/rims (*LX, XLX & BLXL only*)
 XK203 Blue hub/rims (*LX, XLX & BLXL only*)
- XK202 Purple hub/rims (*LX, XLX & BLXL only*)
 XK204 Custom hub/rims (*Select colour:* _____)

Handrim Position

- XY480 Narrow set handrim
 XY485 Wide set handrim
- XL090 Remove excess mounting tabs (*recommended for small wheel gaps*)

Handrim Options

- XL010 Aluminium hard anodised 6 tab (*Standard if no option selected*)
 XL040 Titanium 6 tab
- XL030 Surge LT 6 tab
 XL050 Stainless steel 6 tab
- XL020 Tetra grip 6 tab
 XL140 Ergo gripp 6 tab wide
- XL100 Para grip 6 tab

Tyre Options

- XM060 Schwalbe One (Lightest option)
- XM010 Kenda
  Grey (Std)
 Blue
 Red
- XM130 Kenda black
- XM020 Schwalbe Marathon Plus
- XM040 Shox solid airless (*24", 25" only*)
 XM050 Kenda K885 mountain bike tyre (*24", 25" only*)

Inner Tube Valve Options

- XY500 Schraeder inner tube valve (*Standard if no option selected*)
 
 XY490 Presta inner tube valve
 

* Indicates items that are not part of the certified weight of the TIGA Sub4

CUSHION (non certified weight options)**

Cushion foam options

- XP080 Cushion foam with nylon cover
(select density and size below)
-  Soft (CMS040) Medium (CMS050) Hard (9lb recon)
-  50mm 75mm 100mm

Cushion cover options

- XP090 Airlite cushion cover
(Black)
- XP100 Upholstery cushion cover upgrade to leather
-  Black (Std) Red Grey

Jay Cushion

- XP250 JAY Extreme Active fluid pad
(Price subject to change dependant on size)
- XP251 JAY Easy Visco
(Price subject to change dependant on size)

Other Jay cushion, please specify code, cost, size and description:

FRAME OPTIONS (non certified weight options)**

- XR060 Welded calf strap mounting loops
(To locate calf strap on front frame)
- Specify height from floor
- Optimise measurements



ACCESSORIES (non certified weight options)**

- XR080 Frontwheel assembly
(Only with XB010, TGAXB080, XB150)

(Office use only)

Frontwheel serial
number:

- XP120 Frame protectors neoprene zip fasten with TIGA logo (Nylon
with velcro fasten with XR060)
- XR010 Seat pouch velcro attach (Black)
- XR200 Rucksack with RGK logo (Black)
- XR020 Underseat large storage bag (Black)
- XR090 Tool kit

** indicates options that, when chosen, will not enable RGK to guarantee a Sub4kg product weight

OTHER (non certified weight options)**

Footrest

 XB200 High level footrest

Please indicate front footrest height:

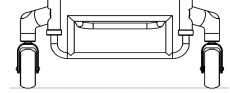
 mm

Castor wheels 3, 4, 5 and 6"

 XC150 Frog Legs aluminium centre 3"x1.4"

 XC145 Frog Legs aluminium centre 6"x1.4"
(Silver hub and black urethane tyre)

 XC140 Frog Legs aluminium centre 5"x1.4"

Wheel Lock Options

 XD020 Underseat scissor

 XD050 Push to lock

Sideguards

 XE030 Screw on aluminium, indicate size on page 4

Backrest Options

 SBAXG020 Folding backrest with 2 position snap lock and angle adjust

Push handle Options

 XG070 Screw in push handles

 XG080 Flip down push handles

Centre of Gravity

 SBAXH130 Square back adjustable centre of gravity
(25-125mm)

 SBAXH140 Round back adjustable centre of gravity
(60-125mm)

Anti-Tip Options

 XJ100 Single sport anti tip
(required to change to TIGA size axle)

Seat Upholstery

 XP040 Seat sling adjustable tension with straps

 XR050 Carbon fibre seat plate

Backrest Upholstery

 XP050 Airtech backrest strap adjustable

Backrest Upholstery Leather Options (only with XP050)

 XP070 Backrest upgrade to leather corners (**only with Airtech upholstery (XP050), N/A with flip down push handles XG080**)

 Black (Std) Red Grey

Backrest Upholstery Stitching Options (only with XP050)

<input type="checkbox"/> Silver (Standard if not indicated)	<input type="checkbox"/> Black	<input type="checkbox"/> Blue
<input type="checkbox"/> Red	<input type="checkbox"/> Light blue	<input type="checkbox"/> Purple

Backrest Upholstery Logo Options (only with XP050)

<input type="checkbox"/> Silver (Standard if not indicated)	<input type="checkbox"/> Black	<input type="checkbox"/> Blue
<input type="checkbox"/> Red	<input type="checkbox"/> Light blue	<input type="checkbox"/> Purple

Backrest Accessories (only with XP050)

 XP110 Backrest with zip pocket

 XP170 Individual backrest embroidery
(Please provide .jpeg file and positioning)

** indicates options that, when chosen, will not enable RGK to guarantee a Sub4kg product weight

NOTES

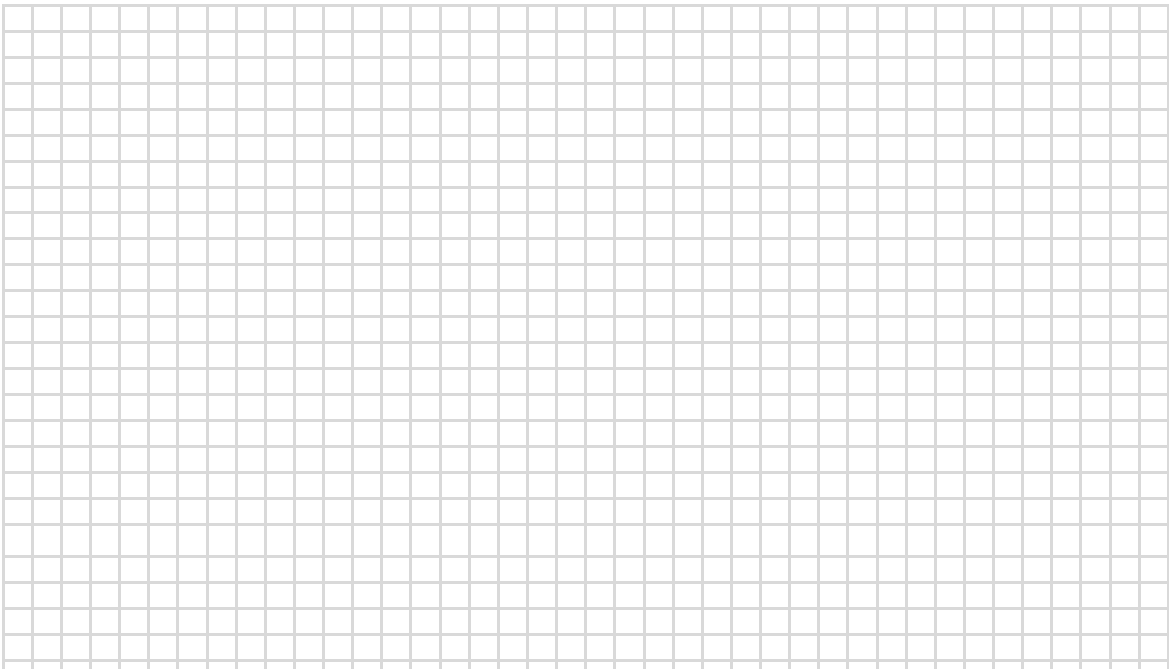

Data Privacy - Customer Order Forms

This data privacy notice tells you about the personal data we collect from you when you purchase one or more of our products. In collecting this personal data, we are acting as a data controller and, by law, we are required to provide you with information about us, about why and how we use your data, and about the rights you have over your data.

Who are we?

We are RGK Wheelchairs. Our address is Units 8a/b/c Ring Road, Zone 2, Burntwood Business Park, Burntwood, Staffordshire, WS7 3JQ UK

You can contact us by post at the above address, by email at data.enquiries@rgklife.com or by telephone on +44 (0)1543 670077 - Any enquiries about our use of your personal data should use the contact details above.

What personal data do we collect?

When you purchase products from us, we ask you for your name, address, contact telephone number, email address. Where necessary some personal details such as; height, weight, limb measurements and any disability or disease will be required. To fulfil your order (unless under contract) we will also need your bank account details.

Why do we collect this personal data?

We will use your personal data to allow the configuration and/or customisation of your purchase, process your order and to send you your goods. We will also send you an invoice and a delivery note. If we have a question about your delivery we will use your telephone number or email address to contact you.

We process special personal data (Health) for the purposes of the provision of healthcare treatment and manufacturing of your product. The Lawful basis for processing normal personal data is Legitimate Interest this enables us to complete your order, process your payment, deliver your goods and fulfil our contract with you.

What do we do with your information?

Your information is stored in our order processing system which is based within the European Union.

We use a third-party courier companies to deliver your goods and we share with them your name, address and telephone number in order to complete the delivery.

We do not use the personal data you provide to make any automated decisions that might affect you. Your data will be shared with an external dealer (if required) and internally with our Sales Team, Customer Services, Financial Services and Quality/Warranty departments to enable fulfilment of your order and provide support services.

How long do we keep your personal data for?

Your non-financial data will be stored for the period of the warranty of the particular product purchased for a maximum of five years.

Your financial data will be stored for seven years as is required by UK Law.

Your rights over your personal data

By law, you can ask us what personal data we hold about you. You can request a copy, correct it if it is inaccurate, request we erase it, and transfer a copy to another data controller.

You can also ask us to stop using your data if you believe we are not processing it lawfully.

To submit a request by email, post or telephone, please use the contact information provided in the 'Who are we?' section.

Your right to complain

If you have a complaint about our use of your information, you can contact the Information Commissioner's Office via their website at www.ico.org/concerns or write to them at:

Information Commissioner's Office
Wycliffe House
Water Lane
Wilmslow
Cheshire
SK9 5AF