

RGK Head Office: Units 8 A/C Ring Road, Zone 2, Burntwood Business Park, Burntwood, Staffordshire, WS7 3JQ, UK
 Telephone:+44 (0) 1543 670077 - Fax:+44(0)1543 670088 - info@rgkwheelchairs.com - www.rgkwheelchairs.com
 To place order: chairorders@rgkwheelchairs.com
 To request quotation: quotes@rgkwheelchairs.com



Distributor Name: _____
 Contact Name: _____

Notes/Comments:

Purchase Order No: _____
 Delivery Address: _____

 Postcode: _____
 Contact Name: _____
 Telephone: _____
 Email: _____

FOR RGK OFFICE USE ONLY

A/C No: _____		
	Who	Date
OK to Quote:		
OK to Confirm:		
Document No:	DOC	

Net Value: £ _____
 Freight: £ _____
 Invoice Value: £ _____
 Payment Received: £ _____

- Base Product
- Standard Configuration
- Mandatory Information
- Option with No extra cost
- Information Required for Option
- Option with Extra cost

FXAXZ010 TIGA FX

XA070 Open design

Max User Weight 125kg

XW010 Full CAD drawing for approval

XW011 Quick CAD drawing for approval
(Basic outline of chair within 2 working days*) *Approximate time only

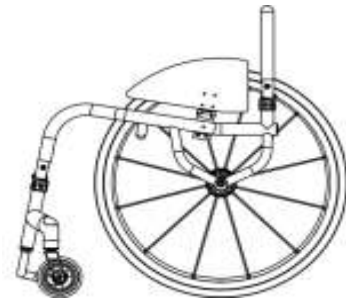

KEY FRAME MEASUREMENTS

XY010 Seat width (Inside of sideguards)

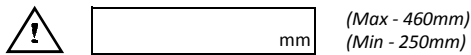

XY020 Seat length



XY030 Extra seat length (Provides additional leg support & hand grip)

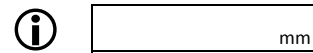

XY050 Front frame height

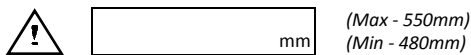

XY060 Rear frame height

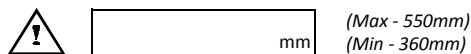

XY070 Frame length

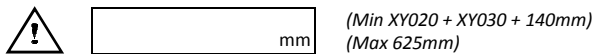

XY072 Castor position

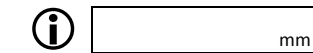

Optimise measurements

XA020 Ergonomic seat

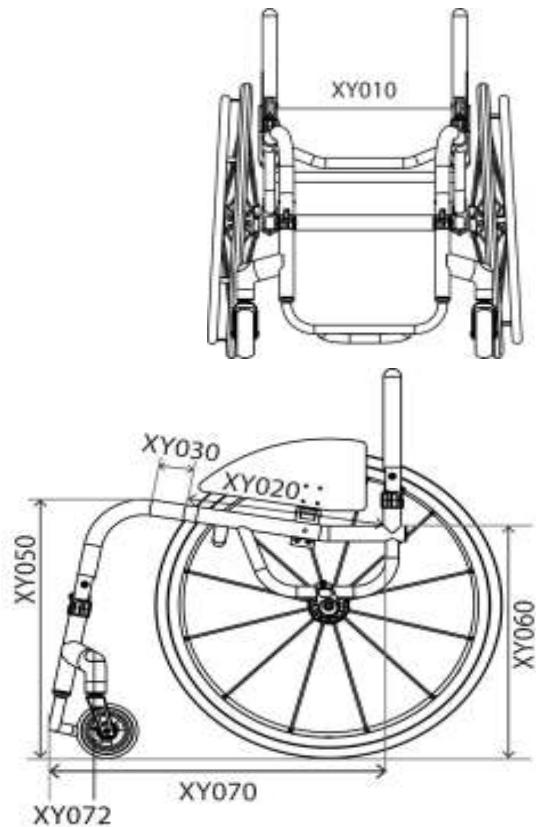
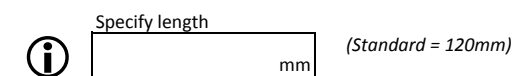

FRONT FRAME AND FOOTREST

Front Frame Options

- XY080 Seat taper design

Specify width
 mm

- Optimise measurements (XY010 - 100mm)

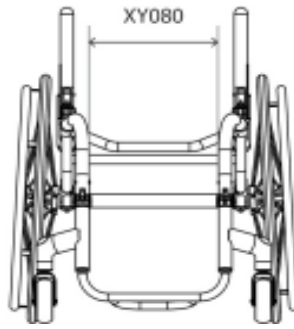

Footrest Design (Choose One)

- XY100 Round design

Castor Size	Max Height	With XB200
3"	115mm	165mm
4"	125mm	175mm
5"	135mm	185mm

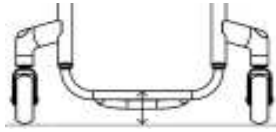

- XB200 High level footrest (Only with XB010, XB080 & XB150)

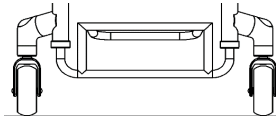

- XY105 Square design

Castor Size	Max Height	With XB200
3"	135mm	185mm
4"	145mm	195mm
5"	155mm	205mm



- XB200 High level footrest (Only with XB010, XB080 & XB150)

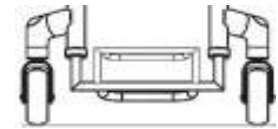

Footrest Individual Measurements

- XY115 Front footrest height

mm

- XY120 Rear footrest height

mm

(Std = 20 lower than front height)

- XY125 Footrest length

mm

(Std = 100mm)

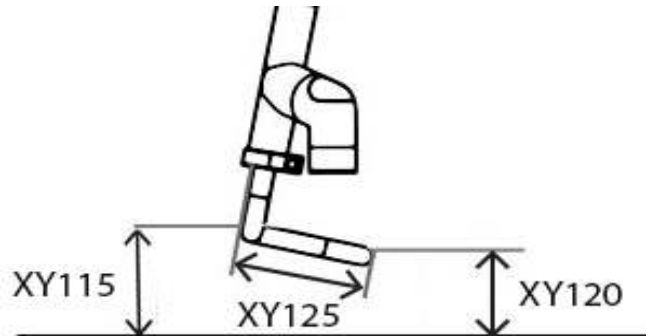

Footrest Style and Cover (Choose One)

- FXAXB110 Tubular footrest welded into frame with carbon plate
 (Supplied with spacer kit to give 20mm upward adjustment)

- XB165 Rubber grip tape (3M safety walk)

- FXAXB120 Clamp-on aluminium plate footrest
 (Angle/height adjustable)

CASTOR WHEELS, FORKS & WHEEL LOCKS

Castor Wheels

3"

- XC150 Froglegs Aluminium centre 3"x1.4"
(Silver hub and black urethane tyre)

4"

- XC060 Soft roll 4"x1.3"
(Black)
- XC110 Froglegs Aluminium centre 4"x1"
(Silver hub and black urethane tyre)
- XC137 Froglegs Carbon composite centre 4"x1.25"
(Black hub & black urethane tyre)
- XC130 Froglegs Aluminium centre 4"x1.4"
(choose colour below)

Choose one castor option only

- | | | | |
|--|--|--|---|
| <input type="checkbox"/> Silver hub & black tyre (Std) | <input type="checkbox"/> Black hub & blue tyre | <input type="checkbox"/> Purple hub & black tyre | <input type="checkbox"/> Silver hub & blue tyre |
| <input type="checkbox"/> Black hub & black tyre | <input type="checkbox"/> Red hub & black tyre | <input type="checkbox"/> Gold hub & black tyre | <input type="checkbox"/> Silver hub & red tyre |
| <input type="checkbox"/> Black hub & red tyre | <input type="checkbox"/> Blue hub & black tyre | <input type="checkbox"/> Green hub & black tyre | |

5"

- | | |
|--|---|
| <input type="checkbox"/> XC070 Soft roll 5"x1.3"
(Black) | <input type="radio"/> XC120 Froglegs Aluminium centre 5"x1"
(Silver hub and black urethane tyre) |
| <input type="radio"/> XC100 Pneumatic Aluminium centre 5"x1"
(Grey) | <input type="radio"/> XC140 Froglegs Aluminium centre 5"x1.4"
(Silver hub and black urethane tyre) |

6"

- XC145 Frog Legs aluminium centre 6"x1.4"
(Silver hub and black urethane tyre)

Castor Forks

- | | |
|--|--|
| <input type="checkbox"/> XC190 Low ride castor fork
(Std when no option selected) | <input type="radio"/> XC210 Froglegs suspension castor fork |
| <i>Note: Colour follows accent</i> | <input type="checkbox"/> Black <input type="checkbox"/> Silver |

Castor Pin Width

- XY330 Castor pin width
(XY010 plus 70mm)

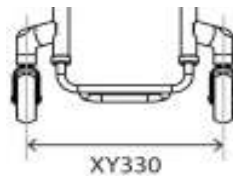

Wheel Lock Options (Choose one)

- | | |
|--|--|
| <input type="checkbox"/> XD020 Underseat Scissor | <input type="checkbox"/> XD050 Push to lock |
| <input type="radio"/> XD030 Compact scissor | <input type="radio"/> XD046 Out Front push to lock |
| <input type="radio"/> XD035 Compact scissor with lightweight fixing
(Only with fixed centre of gravity) | <input type="checkbox"/> XD010 Omit wheel locks |
| <input type="radio"/> XD045 Out Front Compact scissor | |

SIDEGUARDS AND ARMRESTS

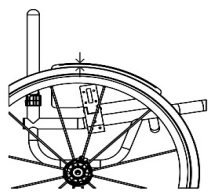
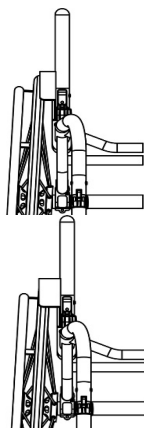
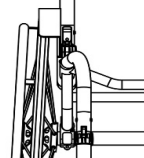
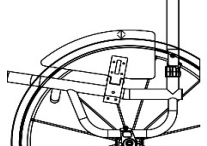
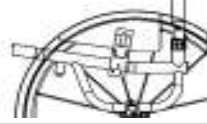
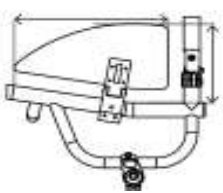
Sideguard		Sideguard with Fender		
Aluminium Options		Aluminium Options		
<input type="radio"/>	XE080 Lift out aluminium	<input type="radio"/>	XE090 Lift out aluminium with fender	
<input type="radio"/>	FXAXE130 Fold flat aluminium	<input type="radio"/>	FXAXE140 Fold flat aluminium with fender	
Carbon Fibre Options		Carbon Fibre Options		
<input type="radio"/>	XE100 Lift out carbon fibre	<input type="radio"/>	XE110 Lift out carbon fibre with fender	
<input type="radio"/>	FXAXE150 Fold flat carbon fibre	<input type="radio"/>	FXAXE160 Fold flat carbon fibre with fender	
ABS Plastic Options		Sideguard Measurements		
<input type="radio"/>	XE120 Lift out ABS plastic	Fender height		
<input type="radio"/>	FXAXE170 Fold flat ABS plastic	<input type="checkbox"/>	10mm above tyre <i>(Standard)</i>	
		<input type="checkbox"/>	Individual above tyre <i>(Min = 10mm)</i>	
		<input type="checkbox"/>	<input style="width: 100px;" type="text"/> mm	
		<input type="checkbox"/>		
Armrest Options		Fender position		
<input type="radio"/>	XF010 Lift out armrest with plastic sideguard <i>(Indicate fixed height)</i>	<input type="checkbox"/>	Centre of tyre <i>(Standard if no option selected)</i>	
<input type="radio"/>	XF020 Lift out armrest with aluminium sideguard <i>(Indicate fixed height)</i>	<input type="checkbox"/>	Outside of tyre	
				
				
Sideguard Measurements		Choose optimised or individual measurements		
Optimised measurements				
<input type="checkbox"/>	25mm above tyre <i>(Follow tyre)</i>			
<input type="checkbox"/>	Individual above tyre <i>(Follow tyre)</i>			
<input type="checkbox"/>	<input style="width: 100px;" type="text"/> mm			
<input type="checkbox"/>	Level with tyre <i>(Follow tyre)</i>			
Individual measurements				
<input type="checkbox"/>	Sideguard length			
<input type="checkbox"/>	Sideguard height			
<input type="checkbox"/>	<input style="width: 100px;" type="text"/> mm			

Choose optimised or individual measurements

Choose optimised or individual measurements

BACKREST

Backrest Height - Fixed or Adjustable (Choose One)

XY230 Fixed height backrest
(Maximum 400mm)

i Specify height
 mm



XY245 Adjustable height backrest
(Maximum height 400mm)
(+/-25mm)

i Specify height
 mm



Backrest Design - Fixed or Folding (Choose One)

FXAXG060 Folding backrest with Q Lock

Q-Lock Colour: Black Silver

Ergonomics - Rearward Positioning (Choose One)

XY360 Backrest angle

i -5 -3 0 +3 +5
 Individual Deg
 (Max -7/+7 Deg)



XG100 Ergonomic backrest

i Vertical height
 mm

i Rearward position
 mm



Ergonomics - Lateral Positioning (Choose One)

XG110 Inward taper
(inside of backrest posts)

i Specify width or per side
 mm



XG120 Outward flare
(inside of backrest posts)

i Specify width or per side
 mm

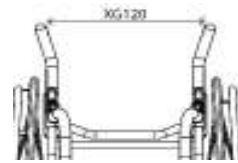

Push handle Options

XG070 Screw in push handles
(N/A with XY245)

XG080 Flip down push handles
(N/A with XY245)

XG085 Flip down push handles height adjustable
(N/A with XY245)

CAMBER BAR

Centre of gravity - Choose one

Adjustable Centre of Gravity

XH110 Square back adjustable centre of gravity
(25-150mm)
(Max seat width 500mm)

Specify measurement mm



XH110

XH120 Round back adjustable centre of gravity
(60-150mm)

Specify measurement mm



XH120

Specify Camber Angle

XY390 Camber angle

0 1 2 3 5



Fixed Centre of Gravity

FXAXH090 V-style fixed centre of gravity
(25-125mm)

Specify measurement mm

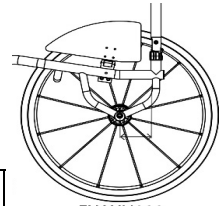

FXAXH090

Centre of gravity - Choose one

Specify Camber Angle

XY390 Camber angle

0 1 2 3 5



Camber Bar Options

XH030 Froglegs suspension camber bar

XH040 Handbike camber bar fixed

0 5
Camber angle (Handbike camber bar)

30 50
Caster height from floor for handbike fitting
(Standard 30mm if not indicated)



Camber Bar Options

XH040 Handbike camber bar fixed

0 5
Camber angle (Handbike camber bar)

30 50
Caster height from floor for handbike fitting
(Standard 30mm if not indicated)



Anti-Tip Options

XJ010 Swingaway anti tip LEFT side (Only with square back frame. Not with XH040)

XJ020 Swingaway anti tip RIGHT side (Only with square back frame. Not with XH040)

XJ100 Single sport anti tip (centre mounted)

REAR WHEELS			
Wheel Size			
<input type="checkbox"/> XY420 24" Wheels	<input type="checkbox"/> XY430 25" Wheels	<input type="checkbox"/> XY440 26" Wheels	
Wheel Gap			
<input checked="" type="checkbox"/> XY460 Rear wheel gap <div style="display: flex; align-items: center; margin-top: 5px;"> ! <div style="display: flex; gap: 10px;"> <input type="checkbox"/> 15 <input type="checkbox"/> 20 <input type="checkbox"/> 25 </div> <div style="border: 1px solid black; width: 100px; height: 20px; margin-left: 10px; display: flex; align-items: center; justify-content: center;"> mm </div> </div>			
Wheel Options (Choose one)			
<input type="checkbox"/> XK010 Fusion 16 spoke <i>(Silver Hub, black spokes)</i>	<input type="radio"/> XK320 Spinergy XLX 12 spoke, cross/radial spoked		
<input type="radio"/> XK050 Spinergy LX 12 spoke	<input type="radio"/> XK060 Spinergy SPOX 18 spoke		
<input type="radio"/> XK150 Spinergy CLX 18 carbon blade spoke	<input type="radio"/> XK070 Spinergy BLXL 18 blade spoke		
Spinergy Colour Options:			
<input type="checkbox"/> Black / Silver hub	<input type="checkbox"/> White / Black hub	<input type="radio"/> XK180 Custom spoke design <i>(Specify colour)</i> Inside: _____ Outside: _____	
<input type="checkbox"/> Red / Black hub	<input type="checkbox"/> Blue / Black hub		
<input type="checkbox"/> Yellow / Black hub	<input type="checkbox"/> Green / Black hub		
<input type="checkbox"/> Pink / Black hub	<input type="checkbox"/> Orange / Black hub		
<input type="checkbox"/> Purple / Black hub			
Custom Anodise Options			
<input type="radio"/> XK190 Black hub	<input type="radio"/> XK200 Silver hub	<input type="radio"/> XK201 Red hub/rims <i>(LX, XLX & BLXL only)</i>	
<input type="radio"/> XK202 Purple hub/rims <i>(LX, XLX & BLXL only)</i>	<input type="radio"/> XK203 Blue hub/rims <i>(LX, XLX & BLXL only)</i>	<input type="radio"/> XK204 Custom hub/rims Select colour: _____	
Handrim Position			
<input type="checkbox"/> XY480 Narrow set handrim	<input type="checkbox"/> XY485 Wide set handrim		
<input type="radio"/> XL090 Remove excess mounting tabs <i>(recommended for small wheel gaps)</i>			
Handrim Options			
<input type="checkbox"/> XL010 Aluminium hard anodised 6 tab <i>(Standard if no option selected)</i>	<input type="radio"/> XL040 Titanium 6 tab		
<input type="radio"/> XL030 Surge LT 6 tab	<input type="radio"/> XL050 Stainless steel 6 tab		
<input type="radio"/> XL020 Tetra grip 6 tab	<input type="radio"/> XL140 Ergo gripp 6 tab wide		
<input type="radio"/> XL100 Para grip 6 tab			
Tyre Options			
<input type="checkbox"/> XM010 Kenda	<input checked="" type="checkbox"/> Grey <i>(std)</i>	<input type="checkbox"/> Blue	<input type="checkbox"/> Red
<input type="radio"/> XM130 Kenda black			
<input type="radio"/> XM020 Schwalbe Marathon Plus	<input type="radio"/> XM060 Schwalbe One <i>(24", 25" only)</i>		
<input type="radio"/> XM040 Shox solid airless <i>(Black) (24", 25" only)</i>	<input type="radio"/> XM050 Kenda K885 mountain bike tyre <i>(24", 25" only)</i>		
Inner Tube Valve Options			
<input type="checkbox"/> XY500 Schraeder inner tube valve <i>(Standard if no option selected)</i>		<input type="checkbox"/> XY490 Presta inner tube valve	
Wheel Accessories			
<input type="radio"/> XK220 Titanium 130mm quick release axle pins <i>(pair)</i> <i>(N/A with XK010 & XK070)</i>	<input type="radio"/> XK300 Offroad wheel set 22" rim with handrim, MTB tyre and axle pins <i>(Replaces 24" wheel with XM010)</i>		
<input type="radio"/> XK240 Quad release axle nuts <i>(pair)</i>	<input type="radio"/> XK310 Offroad wheel set 24" rim with handrim, MTB tyre and axle pins <i>(Replaces 25" wheel with XM010)</i>		

FINISH OPTIONS

Frame & Component Finish

- | | |
|--|---|
| <input type="checkbox"/> XN010 Powder coated frame | <input type="checkbox"/> XN150 Powder coated components |
|--|---|
- | Frame | Comp. | <u>Gloss</u> | Frame | Comp. | <u>Matt</u> | Frame | Comp. | <u>Special</u> |
|--------------------------|--------------------------|------------------------|--------------------------|--------------------------|---------------------|--------------------------|--------------------------|-------------------------|
| <input type="checkbox"/> | <input type="checkbox"/> | Black gloss 103 | <input type="checkbox"/> | <input type="checkbox"/> | Black matt 105 | <input type="checkbox"/> | <input type="checkbox"/> | Chrome Mirror 300 |
| <input type="checkbox"/> | <input type="checkbox"/> | White gloss 100 | <input type="checkbox"/> | <input type="checkbox"/> | White matt 101 | <input type="checkbox"/> | <input type="checkbox"/> | Sparkle silver 170 |
| <input type="checkbox"/> | <input type="checkbox"/> | Grey gloss 132 | <input type="checkbox"/> | <input type="checkbox"/> | Grey matt 131 | <input type="checkbox"/> | <input type="checkbox"/> | Metallic black matt 104 |
| <input type="checkbox"/> | <input type="checkbox"/> | Cream gloss 135 | <input type="checkbox"/> | <input type="checkbox"/> | Light grey matt 133 | <input type="checkbox"/> | <input type="checkbox"/> | Metallic grey matt 130 |
| <input type="checkbox"/> | <input type="checkbox"/> | Red gloss 108 | <input type="checkbox"/> | <input type="checkbox"/> | Navy blue matt 152 | <input type="checkbox"/> | <input type="checkbox"/> | Black sandpaper 201 |
| <input type="checkbox"/> | <input type="checkbox"/> | Yellow gloss 120 | | | | <input type="checkbox"/> | <input type="checkbox"/> | Grey sandpaper 202 |
| <input type="checkbox"/> | <input type="checkbox"/> | Forest green gloss 143 | | | | <input type="checkbox"/> | <input type="checkbox"/> | White sandpaper 200 |
| <input type="checkbox"/> | <input type="checkbox"/> | Green gloss 107 | | | | | | |
| <input type="checkbox"/> | <input type="checkbox"/> | Dark blue gloss 151 | | | | | | |
| <input type="checkbox"/> | <input type="checkbox"/> | Royal blue gloss 154 | | | | | | |
| <input type="checkbox"/> | <input type="checkbox"/> | Blue gloss 174 | | | | | | |
| <input type="checkbox"/> | <input type="checkbox"/> | Duckegg blue gloss 141 | | | | | | |
| <input type="checkbox"/> | <input type="checkbox"/> | Pink gloss 188 | | | | | | |
| <input type="checkbox"/> | <input type="checkbox"/> | Orange gloss 180 | | | | | | |
| <input type="checkbox"/> | <input type="checkbox"/> | Purple gloss 157 | | | | | | |
- Custom
- XN200 Custom paint colour
- | | | |
|--------------------------|--------------------------|--|
| Frame | Comp. | Select colour/RAL: |
| <input type="checkbox"/> | <input type="checkbox"/> | <div style="border: 1px solid black; width: 100px; height: 40px;"></div> |
- | | |
|---|---|
| <input type="radio"/> FXAXN030 Brushed frame | <input type="radio"/> XN160 Brushed components |
| <input type="radio"/> FXAXN050 Polished frame | <input type="radio"/> XN170 Polished components |

Accent Colour (Choose One)

Note: Accent colour includes, forks & castor caps.

- | | |
|--|--|
| <input type="checkbox"/> Black accent | <input type="checkbox"/> Silver accent |
| <input type="checkbox"/> Red accent | <input type="checkbox"/> Blue accent |
| <input type="checkbox"/> Purple accent | <input type="checkbox"/> Carbon accent
(Castor caps only, black for rest) |

UPHOLSTERY

Seat Upholstery

- | | |
|--|---|
| <input type="checkbox"/> XP040 Seat sling adjustable tension with straps | <input type="radio"/> XR050 Carbon fibre seat plate |
|--|---|

Backrest Upholstery

- | | |
|---|--|
| <input checked="" type="checkbox"/> XP050 Airtech backrest strap adjustable | |
| <input type="radio"/> XP060 Backrest upgrade to full leather
(select colour) | <input type="radio"/> XP070 Backrest upgrade to leather corners
(not with flip down push handles) (select colour) |
| <input type="checkbox"/> Black (std) <input type="checkbox"/> Red | <input type="checkbox"/> Black (std) <input type="checkbox"/> Red |

Backrest Upholstery Stitching Options

- | | | |
|--|-------------------------------------|---------------------------------|
| <input type="checkbox"/> Silver
(Standard if not indicated) | <input type="checkbox"/> Black | <input type="checkbox"/> Blue |
| <input type="checkbox"/> Red | <input type="checkbox"/> Light blue | <input type="checkbox"/> Purple |

Backrest Upholstery Logo Options

- | | | |
|--|-------------------------------------|---------------------------------|
| <input type="checkbox"/> Silver
(Standard if not indicated) | <input type="checkbox"/> Black | <input type="checkbox"/> Blue |
| <input type="checkbox"/> Red | <input type="checkbox"/> Light blue | <input type="checkbox"/> Purple |

Backrest Accessories

- | | |
|--|---|
| <input type="radio"/> XP110 Backrest with zip pocket | <input type="radio"/> XP170 Individual backrest embroidery
(Please provide .jpeg file and positioning) |
|--|---|

CUSHION

Cushion foam options

- XP080 Cushion foam with nylon cover
(select density and size below)
- Soft (CMS040) Medium (CMS050) Hard (9lb recon)
- 50mm 75mm 100mm

Cushion cover options

- XP090 Air Lite cushion cover
(Black)
- XP100 Leather cushion cover
(select colour below)
- Black (std) Red

Jay Cushion

- XP250 JAY Extreme Active fluid pad
(Price subject to change dependant on size)
- XP251 JAY Easy Visco
(Price subject to change dependant on size)

Other Jay cushion, please specify code, cost, size and description:

ACCESSORIES

- XR080 Frontwheel assembly
(Only with XB010, TGAXB080, XB150)

(Office use only)

Frontwheel serial
number:

- XP120 Frame protectors neoprene zip fasten with TIGA logo (Nylon with
velcro fasten with XR060)
- XR010 Seat pouch velcro attach (Black)
- XR200 Rucksack with RGK logo (Black)
- XR100 TIGA FX carry bag
- XR090 Tool kit
- XS060 Calf strap

Data Privacy - Customer Order Forms

This data privacy notice tells you about the personal data we collect from you when you purchase one or more of our products. In collecting this personal data, we are acting as a data controller and, by law, we are required to provide you with information about us, about why and how we use your data, and about the rights you have over your data.

Who are we?

We are RGK Wheelchairs. Our address is Units 8a/b/c Ring Road, Zone 2, Burntwood Business Park, Burntwood, Staffordshire, WS7 3JQ UK

You can contact us by post at the above address, by email at data.enquiries@rgklife.com or by telephone on +44 (0)1543 670077 - Any enquiries about our use of your personal data should use the contact details above.

What personal data do we collect?

When you purchase products from us, we ask you for your name, address, contact telephone number, email address. Where necessary some personal details such as; height, weight, limb measurements and any disability or disease will be required. To fulfil your order (unless under contract) we will also need your bank account details.

Why do we collect this personal data?

We will use your personal data to allow the configuration and/or customisation of your purchase, process your order and to send you your goods. We will also send you an invoice and a delivery note. If we have a question about your delivery we will use your telephone number or email address to contact you.

We process special personal data (Health) for the purposes of the provision of healthcare treatment and manufacturing of your product. The Lawful basis for processing normal personal data is Legitimate Interest this enables us to complete your order, process your payment, deliver your goods and fulfil our contract with you.

What do we do with your information?

Your information is stored in our order processing system which is based within the European Union.

We use a third-party courier companies to deliver your goods and we share with them your name, address and telephone number in order to complete the delivery.

We do not use the personal data you provide to make any automated decisions that might affect you. Your data will be shared with an external dealer (if required) and internally with our Sales Team, Customer Services, Financial Services and Quality/Warranty departments to enable fulfilment of your order and provide support services.

How long do we keep your personal data for?

Your non-financial data will be stored for the period of the warranty of the particular product purchased for a maximum of five years.

Your financial data will be stored for seven years as is required by UK Law.

Your rights over your personal data

By law, you can ask us what personal data we hold about you. You can request a copy, correct it if it is inaccurate, request we erase it, and transfer a copy to another data controller.

You can also ask us to stop using your data if you believe we are not processing it lawfully.

To submit a request by email, post or telephone, please use the contact information provided in the 'Who are we?' section.

Your right to complain

If you have a complaint about our use of your information, you can contact the Information Commissioner's Office via their website at www.ico.org/concerns or write to them at:

Information Commissioner's Office
Wycliffe House
Water Lane
Wilmslow
Cheshire
SK9 5AF