



Seismic Anchoring Guide

The Pillar Booth ADA

The Pillar Booth ADA

Step into a Pillar Booth and pause distractions. This booth includes all you need for a private office.

- 01** Active ventilation
- 02** LED lighting
- 03** Power + Conectivity
- 04** Height Adjustable Desk
- 05** Fire Supression
- 06** Acoustic Panels
- 07** Magnetic door seal
- 08** Seismic anchors



What's included

Hardware

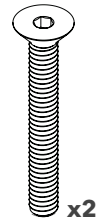

x2

A Flat Head
1/4 x 2"

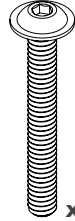

x12

B Flanged
1/4 x 2"

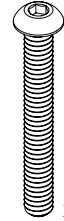

x8

C Button Head
1/4 x 2"

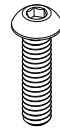

x42

D Button Head
1/4 x 1"



x10

E Flanged
1/4 x 1 1/2"



x8

F Pan Head
1/4 x 1 1/2"



x12

G Seismic
anchor screw*

Tools

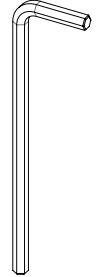

Allen wrench

Ceiling

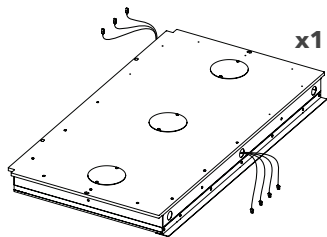

x1

Left

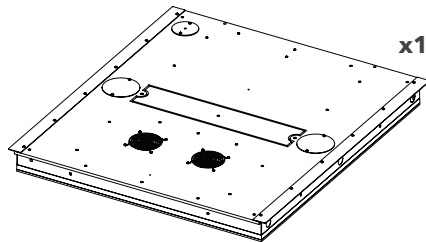

x1

Center

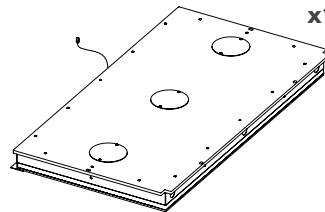

x1

Right

Base

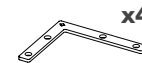

x4

Corner Bracket

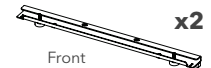

x2

Front

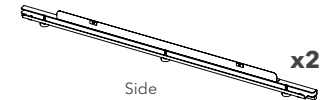

x2

Side

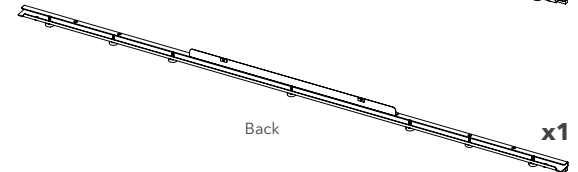

x1

Back

*Seismic anchor screws are optional for use with seismic install only (steps 27 & 28).

Walls

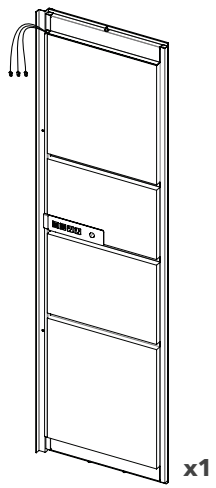

Left Back **x1**

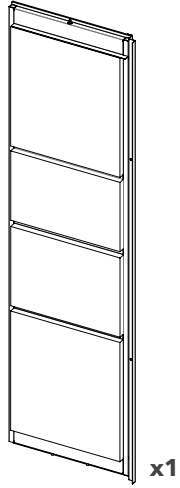

Right Back **x1**

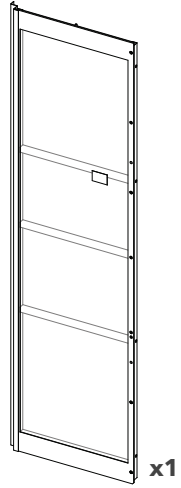

Left Front **x1**

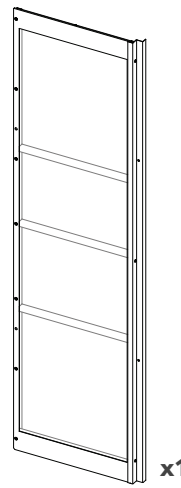

Right Front **x1**

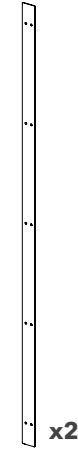

Steel Straps **x2**

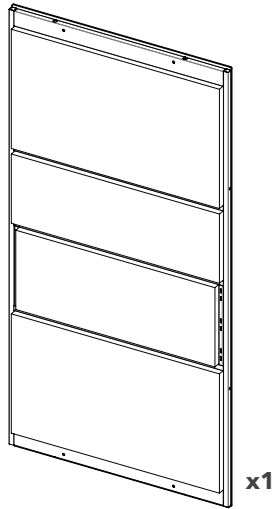

Left Side **x1**

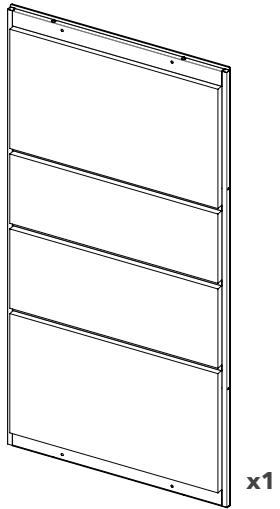

Right Side **x1**

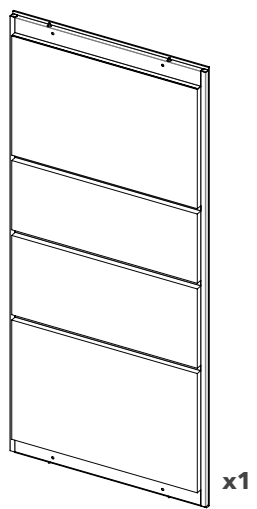

Center Back **x1**

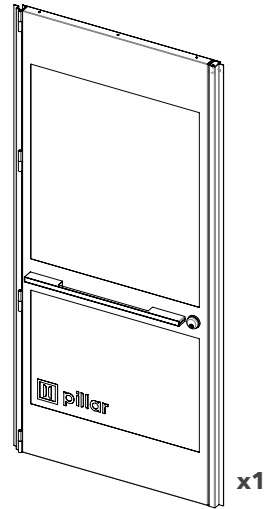

Door **x1**

Magnetic Covers

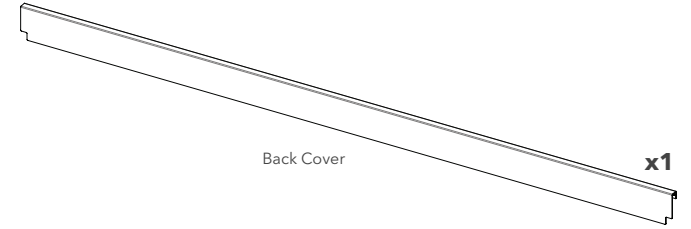

Back Cover **x1**

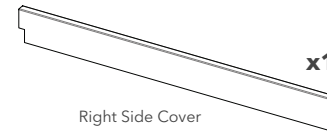

Right Side Cover **x1**

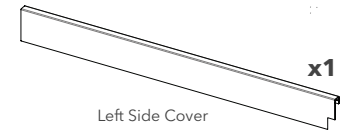

Left Side Cover **x1**

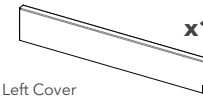

Front Left Cover **x1**

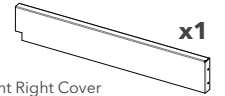

Front Right Cover **x1**

Desk

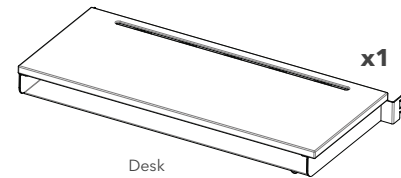

Desk **x1**

Before you start

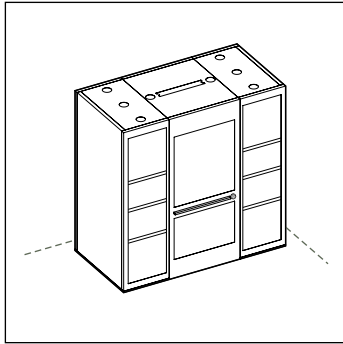

Assemble the booth in its final location, so you don't have to move it.

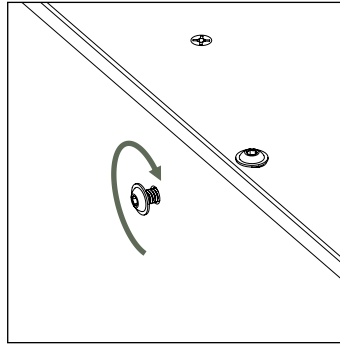

Wait until the very end to fully tighten all the bolts.

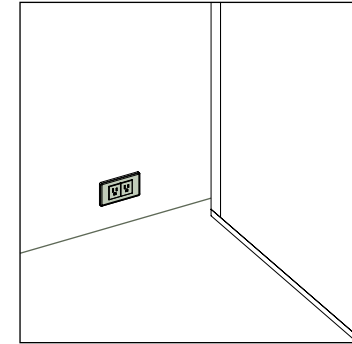

Make sure your booth is near an outlet.

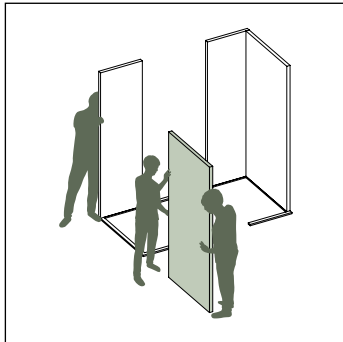

You will need 3 people to assemble the booth (able to lift ~50 lbs).

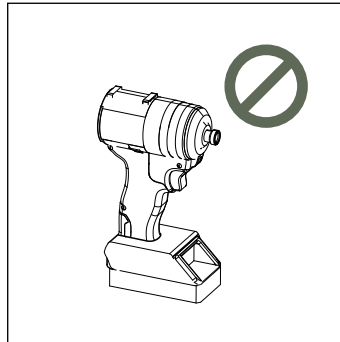

Do not use an impact driver. Over-tightening during assembly can strip the bolts or crack the polycarbonate material.

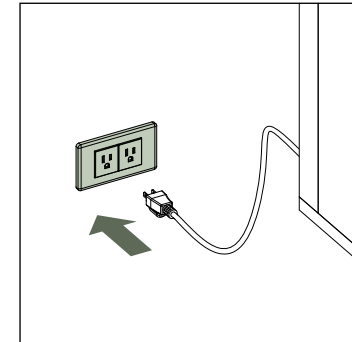

Wait until the booth is completely assembled to plug it in.

25

Remove the lower acoustic panels

Pull the panels to remove them. They are velcroed in place.

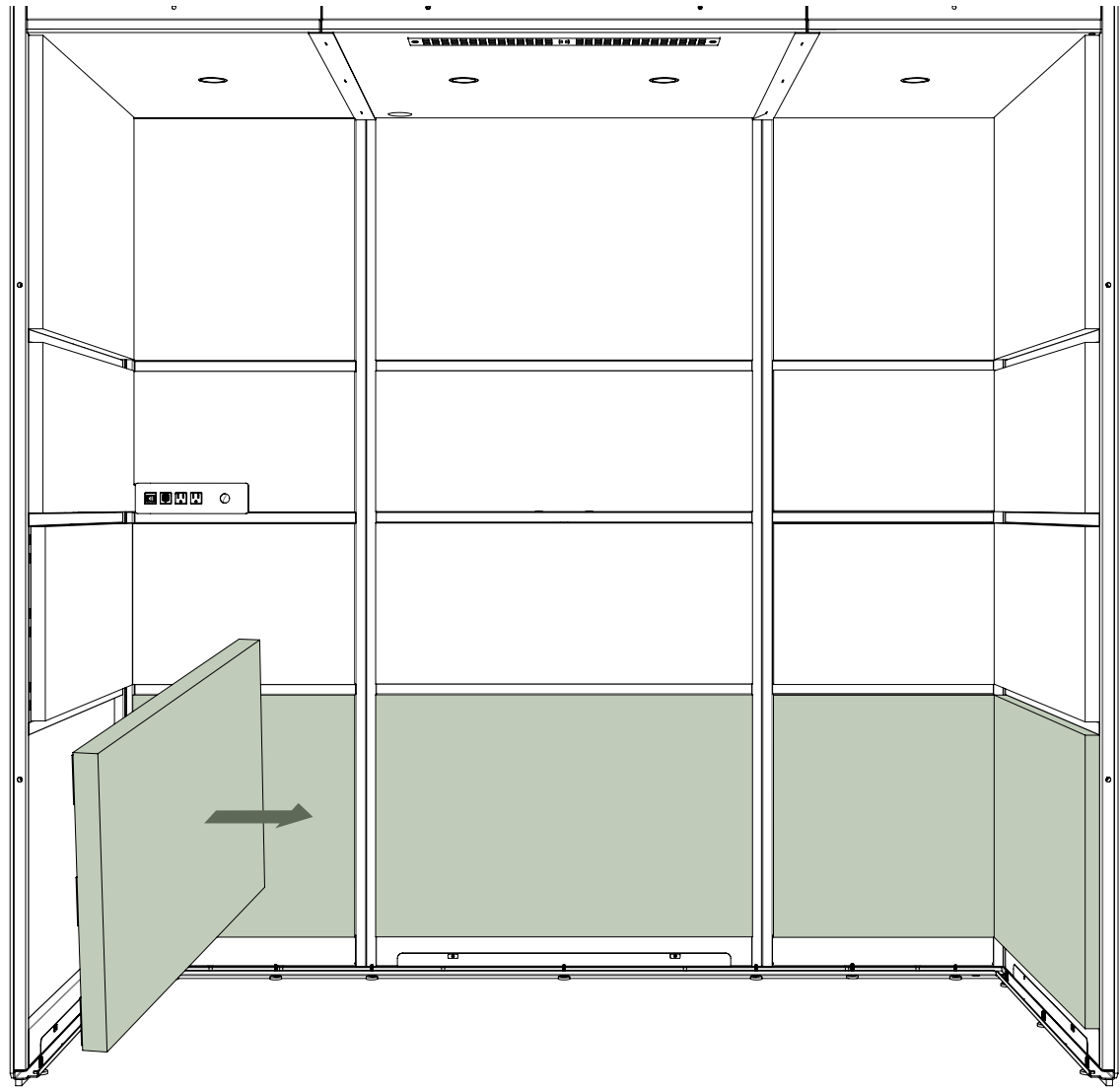

26

Re-level the booth

Check to make sure the booth is still level and that all the corners are squared.

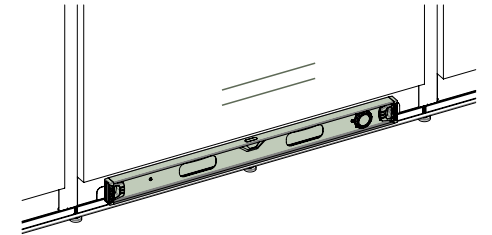
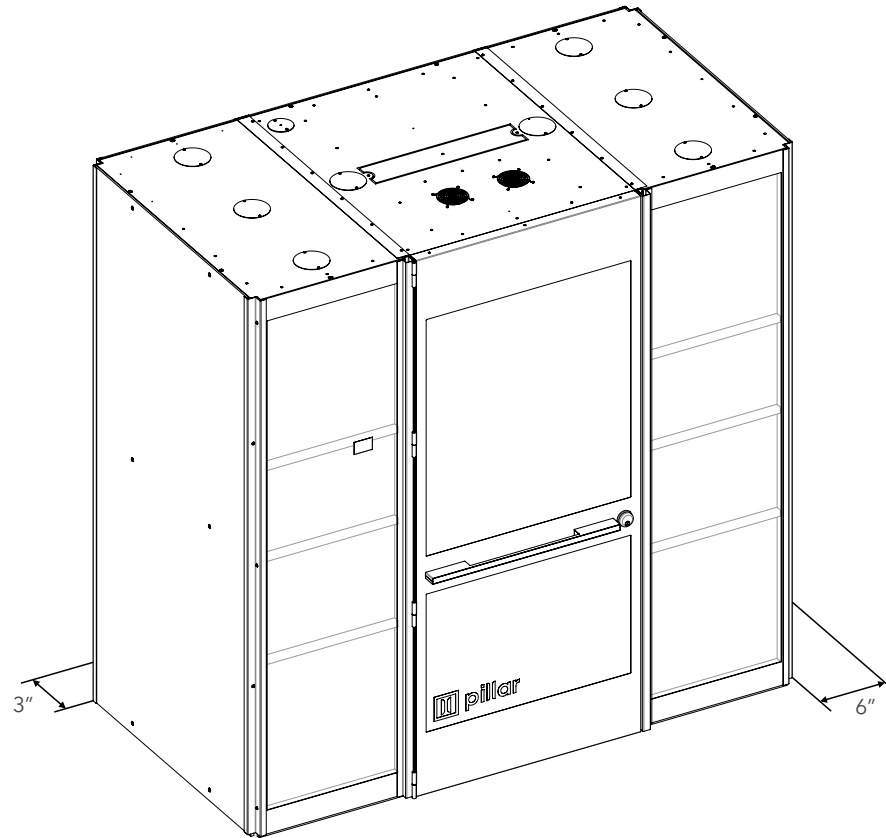

Note: Make sure the booth is leveled.

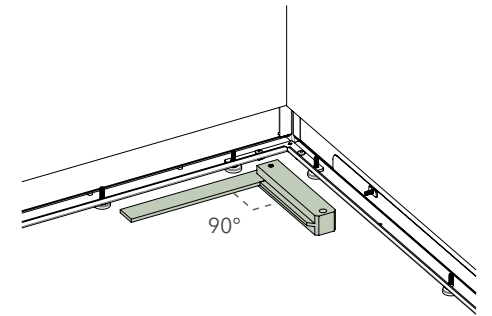

Note: Make sure all corners are squared.

27

(optional for seismic anchoring)

Anchor the booth's back and side

Securely anchor the booth's back and side to the floor using the provided seismic anchoring screws.

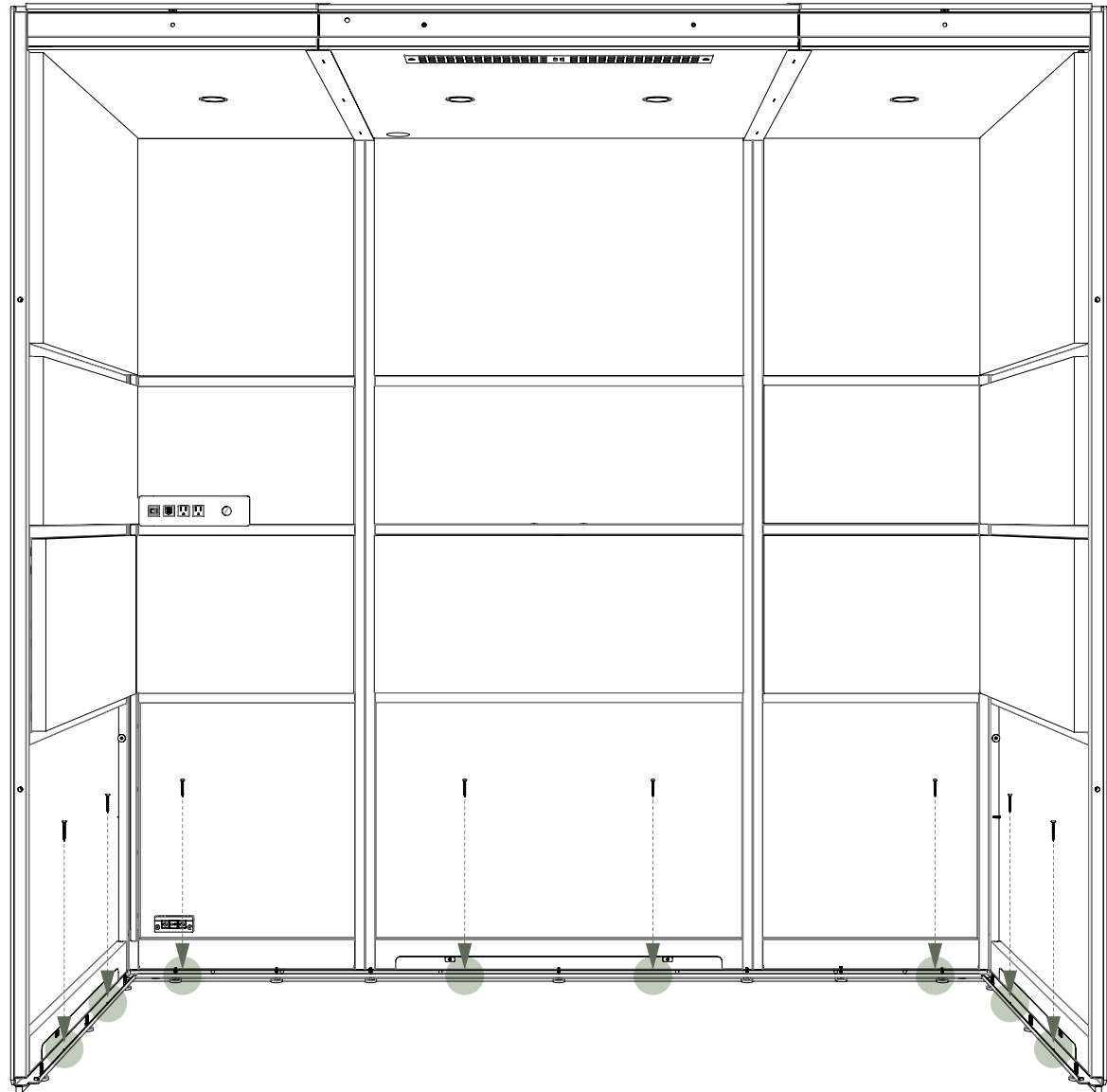

F Seismic anchor screw



x8

28

(optional for seismic anchoring)

Anchor the booth's front

Securely anchor the booth's front to the floor using the provided seismic anchoring screws.

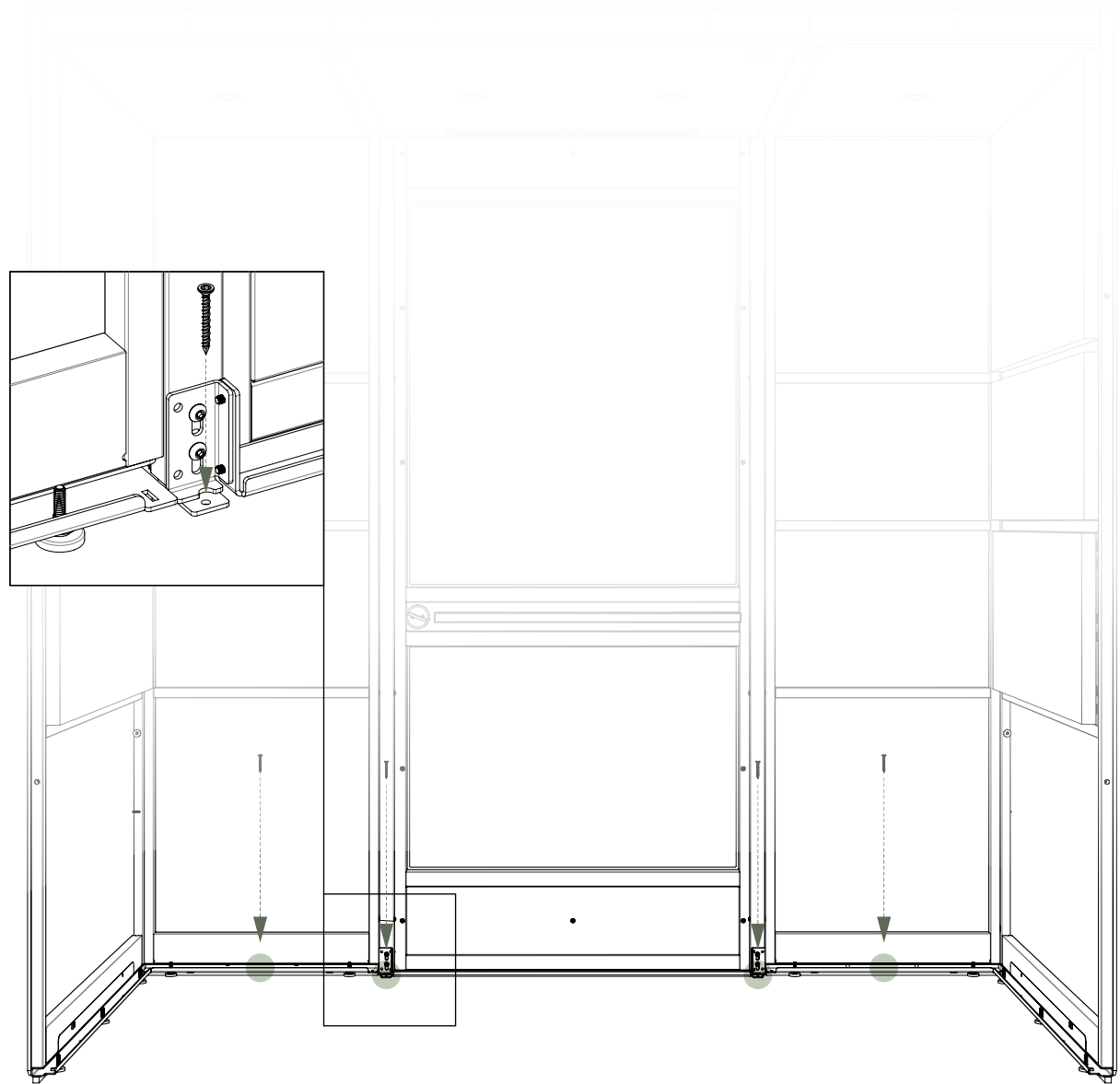

F Seismic anchor screw



x4

29

Reinstall the acoustic panels

Replace the 5 lower panels.

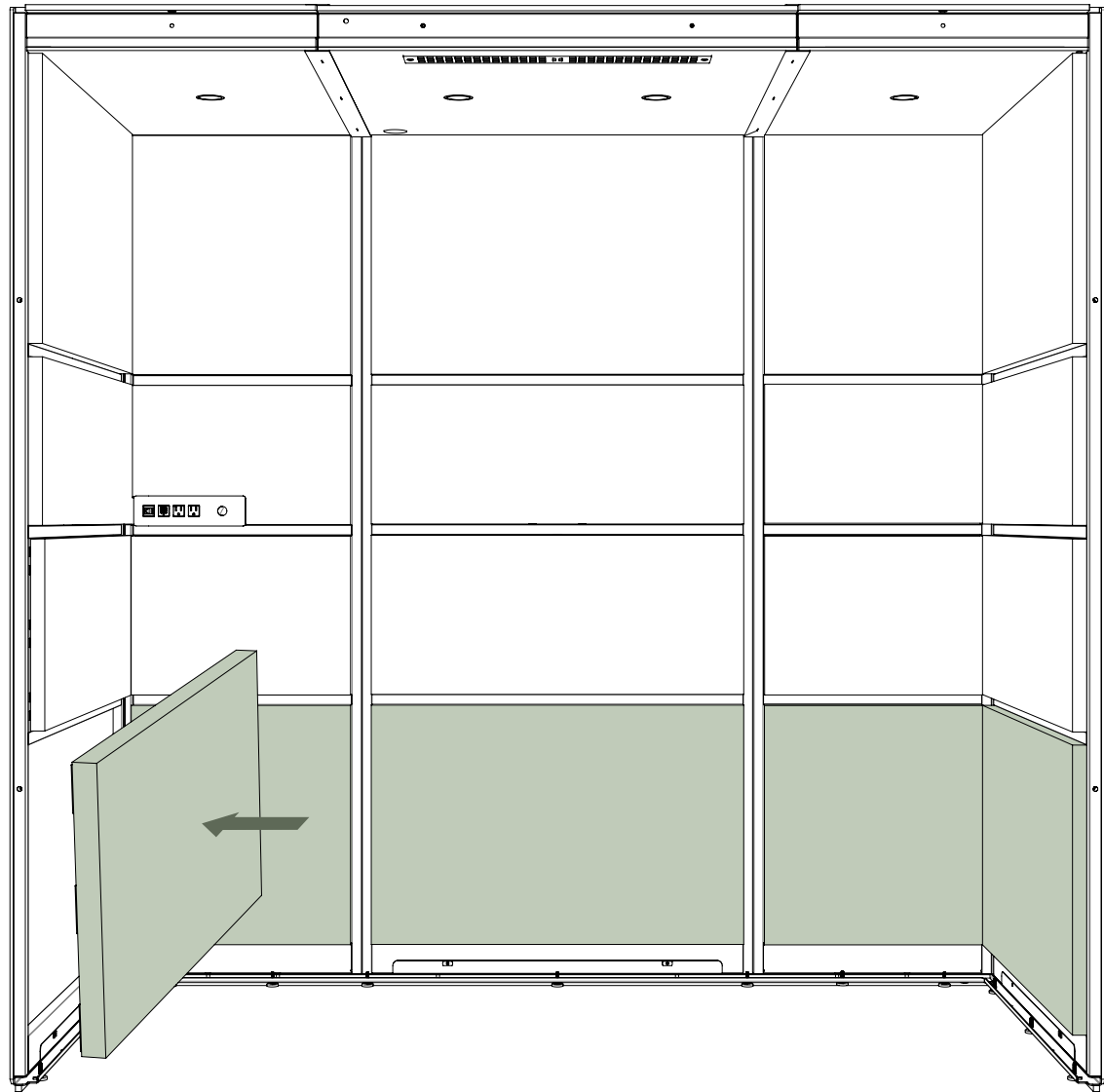



Step into a Pillar Booth
and pause distractions.

