

EAGO

EAGO Sanitary Ware Co., Ltd.

Factory Add: Shiling Development Zone, Xiaotang Town, Nanhai District, Foshan City, Guangdong, China

National Service Hotline 800-8301359



EAGO

DZ961F8 Installation Instruction

Important safe information

1. Please read this instruction and assemble the steam shower according to it.
2. The leakage protection switch must be installed. Besides, please try it to check whether it is safe enough before formal using.
3. The ground line of the product must be connected to the earth permanently.
4. To avoid being shocked by the electricity, please prepare enough plugs and fixed them near to the steam shower. Please change those old or disrepair wires in time.
5. It is strictly forbidden to use the steam shower after drink or eat some hypnotic medicine.
6. Children should be guided by parents while using.
7. Especially note: The using water temperature should not pass 60 centigrade or 140 Fahrenheit.
8. Do not use any strong chemical liquid such as Vitriol, Hydrochloric acid, Lye and so on to clean the steam shower.
9. There is a connecting screw in the Wire Connecting Box, to avoid being shocked by the electricity, please be sure to connect this screw to the ground wire which is fixed on the power board. It is better to use the same size insulated wire to connect them, and the connecting wire diameter should not less than 1.5 square millimeter cooper-core wire.
10. Warning: To avoid being shocked by the electricity, please be sure to connect the DFCI/RCD to the ground plug.
11. If the steam shower with 3KW/4.5KW/6KW steam generator, the diameters of wires which are used not less than 2.5square millimeter/ 4square millimeter/ 6square millimeter.
12. It is not allowed to use any moisture enhancing machine in the steam shower.

Installation wiring diagram

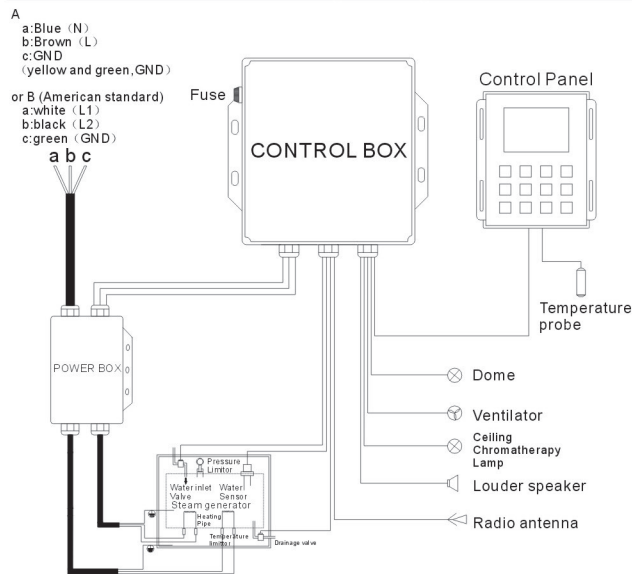

Electrical parts specification

Configuration Parameter	massage pump	steam generator	ceiling light	exhausting fan	Solenoid valves	CPU	Speaker	Note
Rating voltage		AC220-240V/50HZ	DC12V	DC12V	DC12V	AC220-240V/ 50HZ		
Rating voltage		AC240V/60HZ	DC12V	DC12V	DC12V	AC240V/60HZ		
Rating power		3000W	10W	3W	5W		10W	
Rating power		4500W	10W	3W	5W		10W	
Rating power		6000W	10W	3W	5W		10W	

CONTENTS

- 01-02 Component Directions
- 03 Technical Drawing
- 04-10 Installation steps
- 11-12 Control panel keys and function directions
- 13 Illustration for cleaning function
- 14 Maintenance service card
- 16 Troubles shooting

Parts instruction

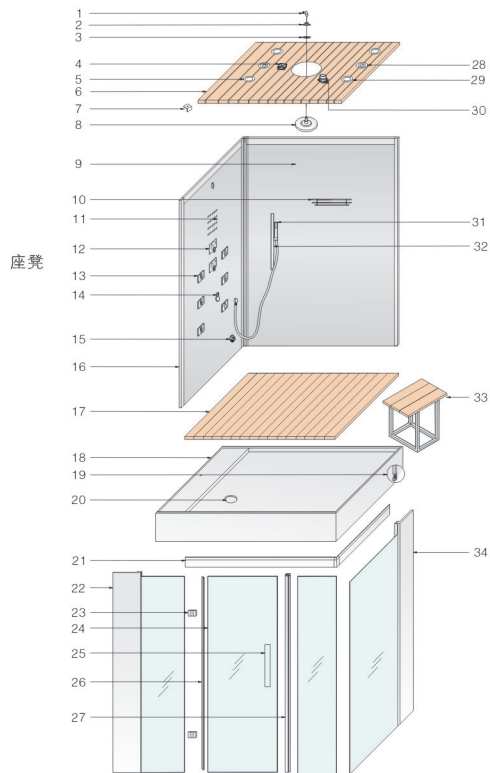







1、 4"4 copper elbow	2、 1/2" copper nuts	3、 4mm plastic seal	4、 90X90 Ventilator
			
5、 Colorful light	6、 Top cover	7、 stainless steel block	8、 Head shower
			
9、 back panel	10、 Glass shelf	11、 F8 computer control panel	12、 Square 3 ways faucet
			
13、 Squire jet	14、 cleaning cup	15、 Steam mouth	16、 Side back panel
			
17、 959 solid wood floor	18、 shower base	19、 Adjustable leg	20、 Plastic drainer
			
21、 fixed aluminum profile	22、 left fixed door	23、 Door hinge	24、 movable door
			

Parts instruction

25、H-style handle	26、Movable door	27、Water proof rubber
		
28、L008A magnetic strip (6mm)	29、Daylight lamp	30、Loud speaker
		
31、Hand shower	32、Hand shower bracket	33、Stool
		
34、Right fixed door		

Parts package

4x10mm self-locking screw:39pcs	stainless steel block:5pcs
	
4x50mm screw with cushion:4pcs	4x16mm self-locking screw:6pcs
	
2.5mm Hexangular Wrench:1pcs	3mm Hexangular Wrench:1pcs
	
4m Hexangular Wrench:1pcs	Binding strip:10pcs
	

Technical drawing for water and electricity

Size: 1500X900X2265mm(left side)

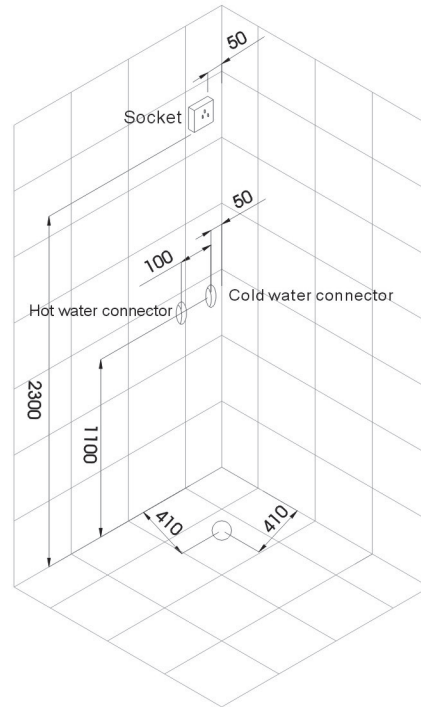
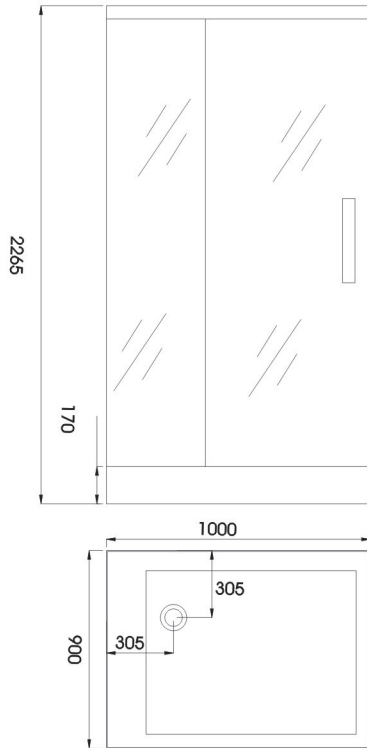

Installation instruction 1

Install the shower base

1. Take the shower base out from the carton and put it on the floor carefully.
2. Put the level ruler on the shower base to check whether the shower base is level. If not, please use a Wrench to adjust the adjusting legs to make the shower base become level. Illustrated in the drawing A.

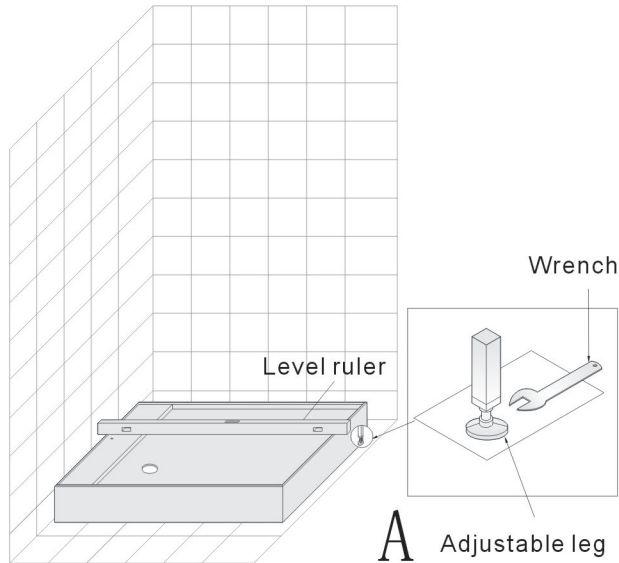

Installation instruction 2

Install the back panels

1. Take the No.1 panel out of the carton and put it on the shower base carefully. Please be sure to make one person to stand beside to hold it on safely.
2. Take the No.2 panel out and put it beside of the No.1 panel carefully. Insert the No.2 panel to the aluminum profile of No.1 panel. Then make one person hold on the No.1 and the No.2 panels, the other person uses a Philip Screwdriver to fix them with 4x10mm self-locking screws. Illustrated in the drawing B.

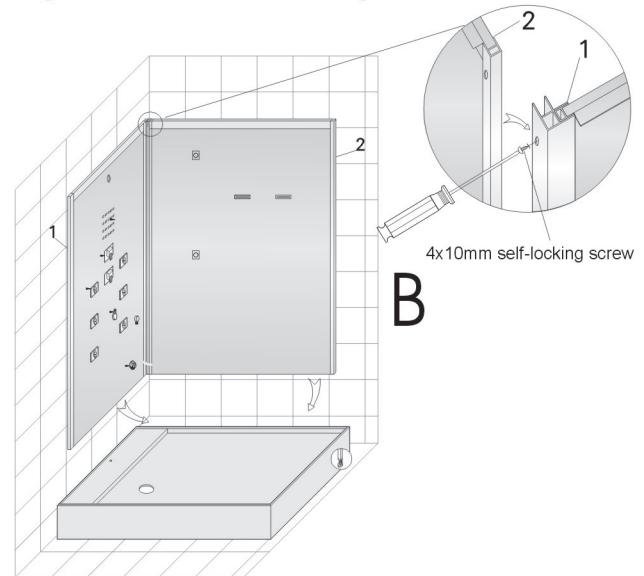

Installation instruction 3

Install front fixed glass doors

1. Install the bottom rubber to the No.3 fixed door, illustrated in the drawing A, then insert the No.3 fixed door to the aluminum profile of No.1 side panel. Use a Phillip Screwdriver to fix them well with 4x10mm self-locking screws. Illustrated in the drawing B.
2. Use the same way to install the No.5 side clear panel, and fix it to the No.2 back panel. Illustrated in the drawing C.
3. Install the bottom rubber to the No.4 fixed door, illustrated in the drawing A, then cover the Corner Water Proof Rubber to the No.5 side clear panel, and insert the No.4 fixed door to the Corner Water Proof Rubber, illustrated in the drawing D.

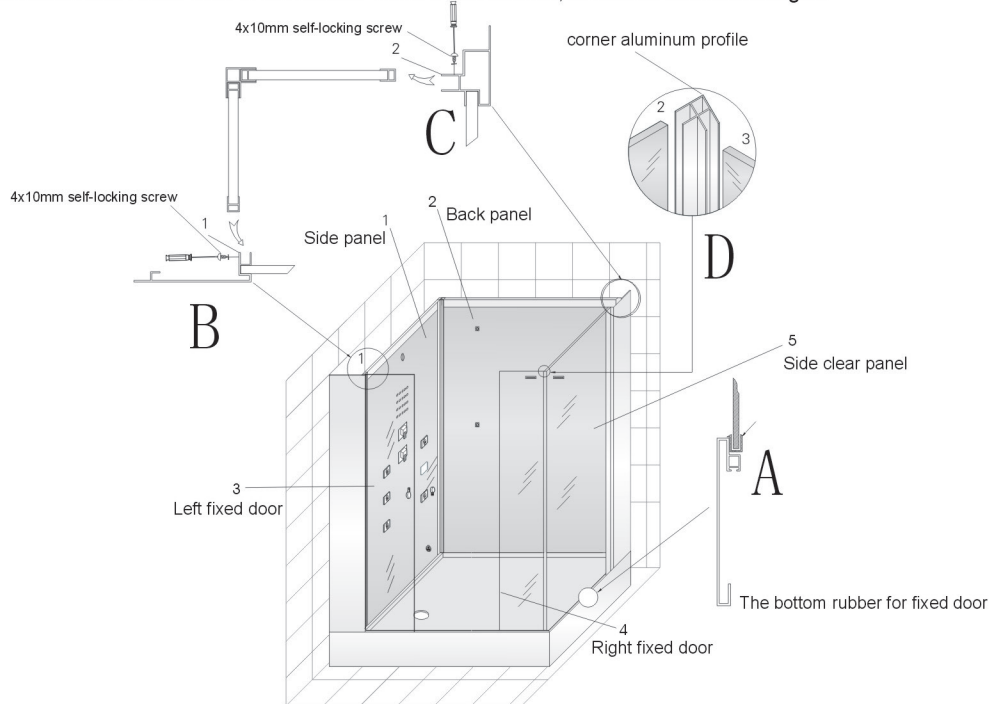

Installation instruction 4

Fix all the fixed doors and back panels

1. Cover the 2 pieces Top Aluminum Profiles onto the No.3 and No.4 fixed doors and No.5 side clear panel, and then use a Phillip Screwdriver to fix the 2 pieces Top Aluminum Profiles to the No.1 side panel and No.2 back panel with 4x50mm self-locking screws. Illustrated in the drawing A.
2. Use a Plastic Elbow to join the 2 pieces Top Aluminum Profile together, and then use a Phillip Screwdriver to fix them to the No.4 fixed door and No.5 side clear panel with 4x50mm self-locking screws, illustrated in the drawing B.
3. Use a Phillip Screwdriver to fix the aluminum profile of No.3 fixed door to the skirt of the shower base with 4x10mm self-locking screws. Illustrated in the drawing C.
4. Fix No.1 and No.2 panels to the shower base with 4x16mm self-locking screws, illustrated in the drawing D.

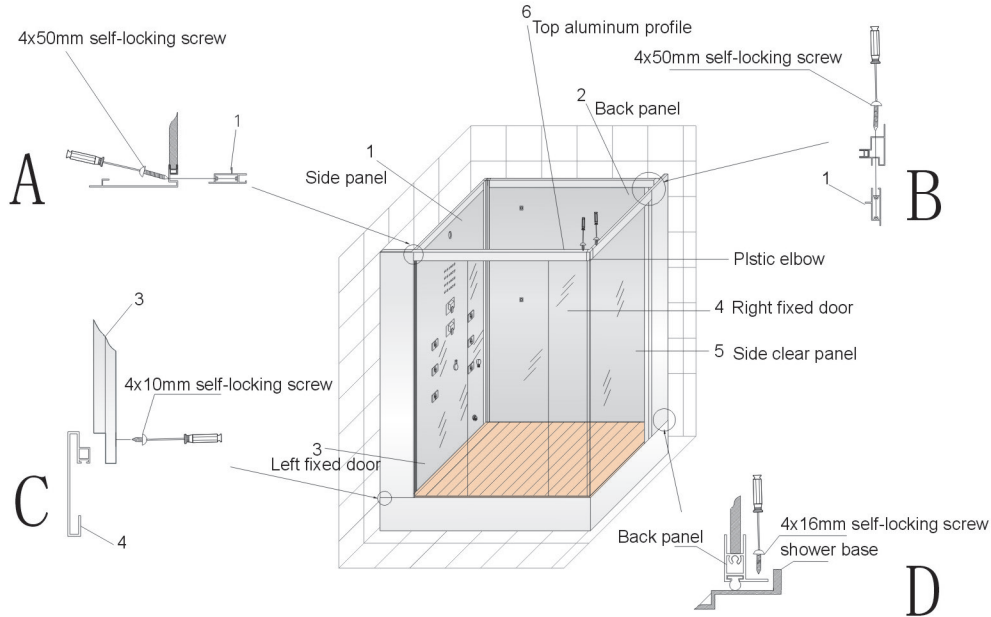

Installation instruction 5

Install the Movable Door.

1. Put the Top Cover on the shower room, and then use a Phillip Screwdriver to fix the Top Cover to the No.1 and No.2 panels with 4x10mm self-locking screws and Iron Block, illustrated in the drawing A1. Then fix the Top Cover to the No.3 door and No.5 side clear panel with 4x10mm self-locking screws and Iron Block, illustrated in the drawing A2.
2. Put the Movable Door on the shower base, and then make one person to hold it on, the other person use a Hexangular Wrench to install the Movable Door to the No.3 fixed door with hinges and 5x12mm screws. Illustrated in the drawing B.
Note: In case the Movable Door can't close very well, please use a Hexangular Wrench to adjust the hinge, until the Movable Door become close well. Please adjust the hinge according the drawing B.
3. Use a Hexangular Wrench to install the handle to the Movable Door, illustrated in the drawing C.

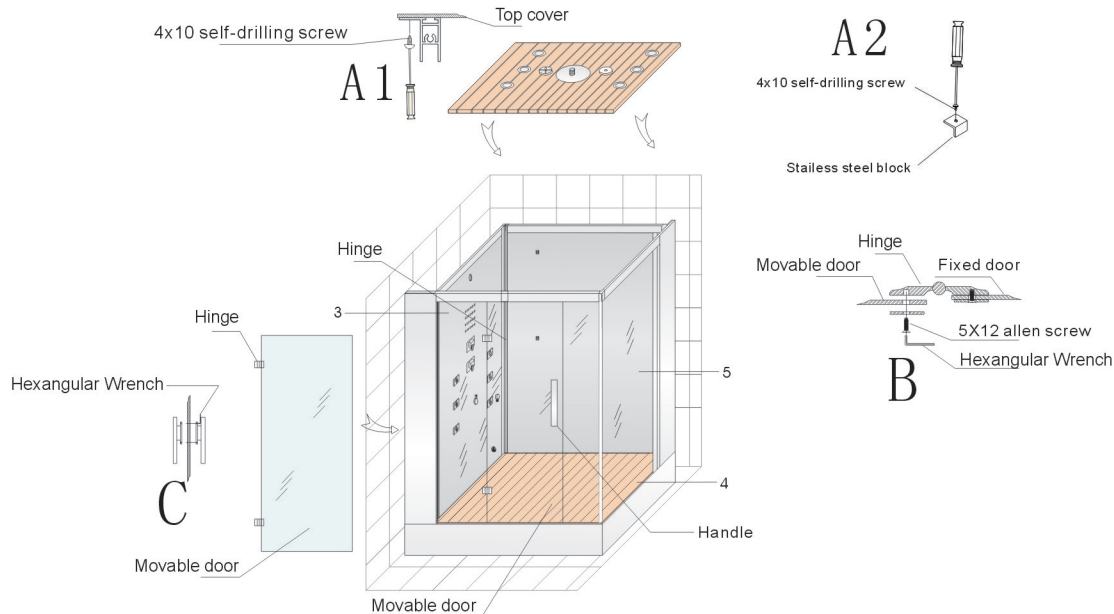

Install Accessories

1. Install the top water proof rubber picture A to the top of the Movable Door.
2. Install the side water proof rubber picture B to the left side of the Movable Door.
3. Install the bottom water proof rubber picture C to the bottom of the Movable Door.
4. Install the 2pieces Magnetic Strips to the right side of the Movable Door and the left side of the No.4 fixed door.
5. Install the Up and Down Hand Shower Bracket: Use a Phillip Screwdriver to install the Up and Down Hand Shower Bracket to the back panel with 4x16mm screws, 4mm plastic cushion, 6mm plastic cushion and 4mm nuts. Illustrated in the drawing E.
6. Connect the hand shower chain to the hand shower socket. Illustrated in the drawing F.
7. Install the Glass Shelf: Use a Phillip Screwdriver to fix the Glass Clip to the back panel with 4x16mm screws, 4mm plastic cushion, 6mm plastic cushion and 4mm nuts, illustrated in the drawing G. Then put the Glass Shampoo Holder on the track of Glass Clip and use a Phillip Screwdriver to fix them well.

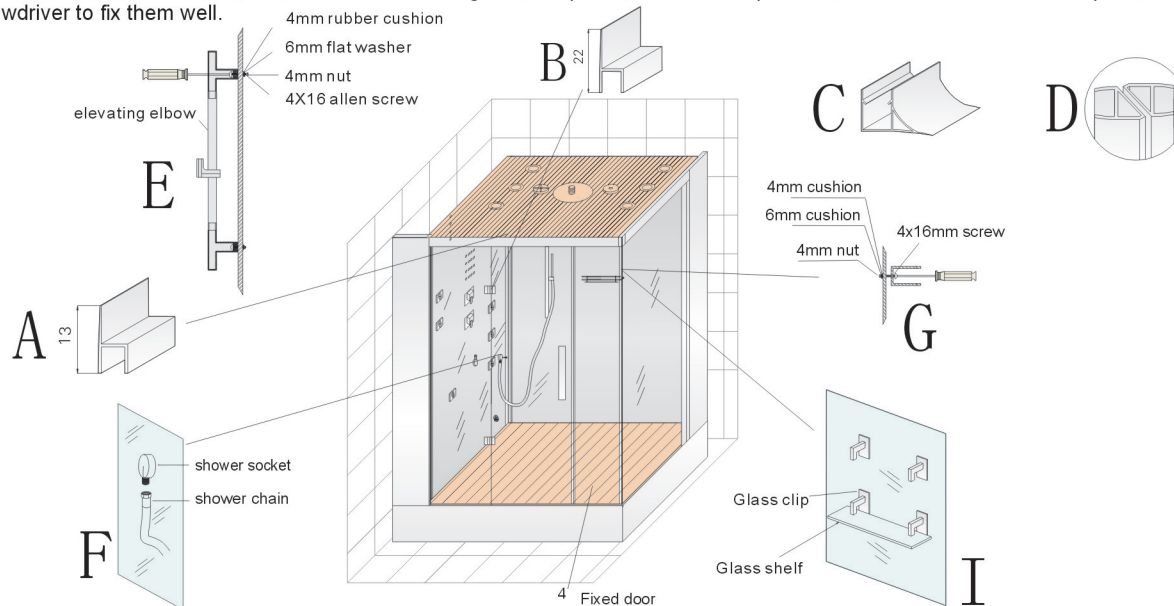

Installation instruction 7

Connect Wires

1. Insert the Single Side Rubber to the 2pieces Top Aluminum Profiles, illustrated in the drawing A.
2. Put the Solid Cherry Wood Floor in the steam shower carefully, and then put the stool on the floor.
4. Find out the Ventilator sign, the Lamp sign, and the Loud Speaker sign which are on the behind of the back panel, then connect the relative wires of these spare parts to the relative sockets. Illustrated in the following drawing.

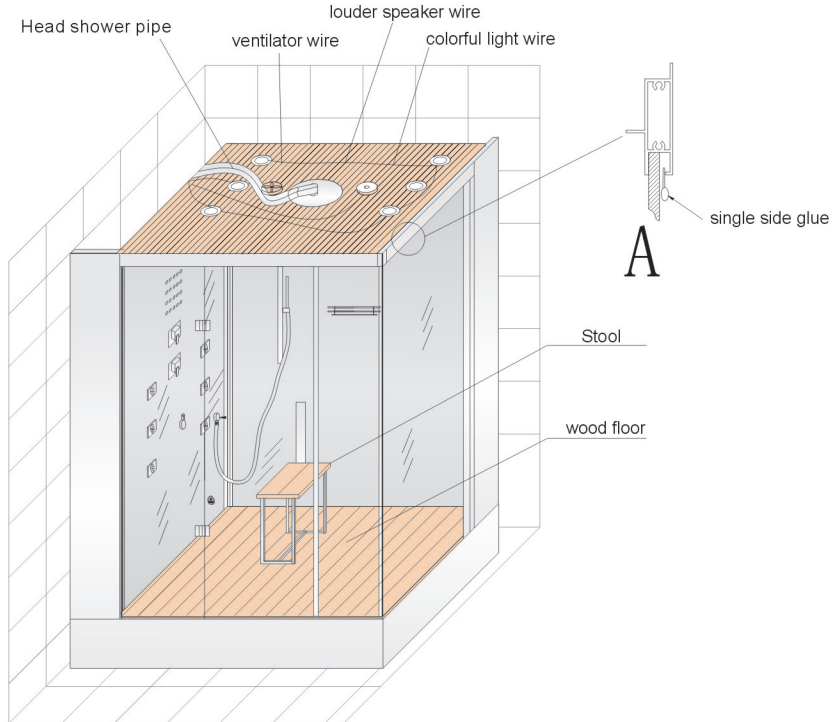

Connect Fittings and Water Pipes

1. Connect the head shower pipe to the head shower joint. Connect the water outlet pipe to the shower base connect the steam pipe to the steam outlet, illustrated in the drawing A.
2. Connect the hot water inlet pipe and the cold water inlet pipe separately to the relative joints. Illustrated in drawing A, B and C.
3. Especially note: The thermostatic faucet is an optional function, just when customers require to install this spare part and we will do, the standard steam shower is without the thermostatic function. Illustrated in drawing D and E.

Note: Before use the steam shower, please try to test whether all the functions are ok.

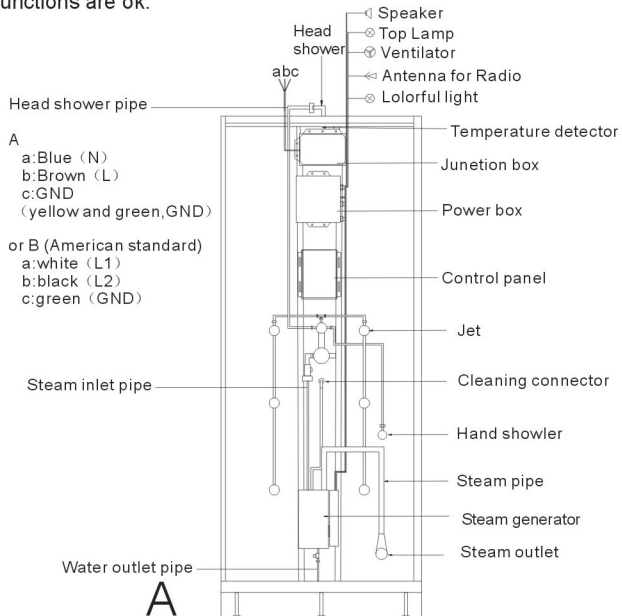

Standard faucet

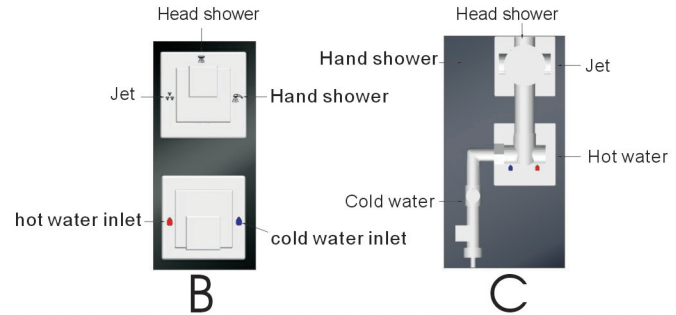

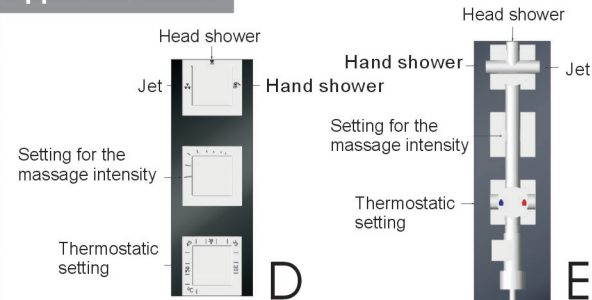

Optional faucet

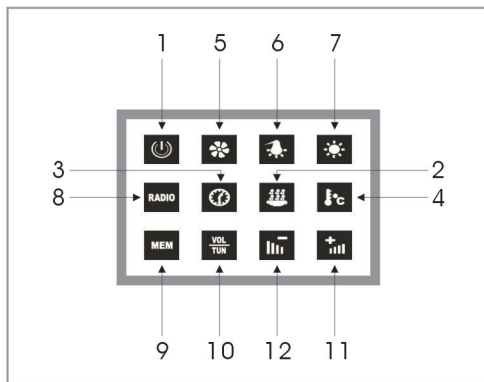

F8 Control panel keys and operating instructions



1).Power key

Press  to switch on the steam room, press  again to switch it off. The steam room will shut down in 60 minutes automatically. (As picture1)



As picture1



2).Steam key

Press  The steam generator starts working. The temperature will be shown on the control panel like the picture 2.



As picture2



3).Time adjusting

After the steam function is turned on, press  will increase the setting time. When press the  more than 1 second, the setting time will be increased continuously until you stop pressing.Or, just when it reaches the maximum limiting time(50 minutes) after that it will return to the minimum limiting time(5 minutes) autmotatically. (As picture3)



As picture3

4).Temperature adjusting key



After steam function is turned on, press  will increase the temperature. When press  more than 1 second, the setting temperature will be increased continuously until you stop pressing Or,just when it reaches the maximum limiting temperature that it will return to the minimum limiting temperature automatically. (As picture4)

Note:The temperature setting range is between 20 °C-50°C.The controlled temperature tolerance: $\pm 3^{\circ}\text{C}$ The default temperature is 40°C.



As picture4

5).Ventilator key

Press  to turn on the ventilator , press  again to turn off the ventilator.



As picture5

F8 control panel key and operation instructio



6).Color light key

Press  to turn on the color light. After the color light is turned on, each more press will change the different colors of the light. The color light works in this sequence: Turn on, blue ---blue and red ---red----red and orange---orange ---orange and blue---blue---circulating---turn off.



As picture6

7).lamp key

Press the  key to turn on the lamp, press  again and turn it off. (As picture 6)



8).Radio key

Press  to turn on the radio, press  again to turn off the radio.(As picture 7)





As picture7

9).Channel memory key

Press  and release within 1 second, the frequency of current channel will be changed; Press  and hold it more than 1 second, the frequency of current channel will be saved.It can memory total 8 channels.



10).Select key

This key gets double functions. When the radio is turned on, this key shows the Frequency function.Press the  key and it can be switched from the frequency to the volume function. Press the  key, on the Display will show like the (Picture 10) or (picture 9). (Picture 9) is for volume and (picture 10) is for frequency.



As picture8



11).Volume up key

After the radio is turned on (As picture9), press  will increase the volume. Hold on the key more than 1 second, volume will keep increasing until the key is released. When(picture10) shows on the display, press  will increase the frequency.Hold on the key more than 1 second, the frequency will keep increasing until the key is released.



As picture9

12).Volume down key

After the radio is turned on, when (Picture 9) is shown on the display, press  will decrease the volume. Hold on the key more than 1 second, volume will keep decreasing until the key is released. When (picture10) is shown on the display,press  will decrease the frequency.Hold on the key more than 1 second, the frequency will keep decreasing until the key is released.



As pictur10

User's manual for cleaning the steem generator

Using steps: Turn off the power first, and then open the lid of cleaning cup, put the cleaning liquid in the cleaning cup, after that, cover the lid back. Now turn on the power, start the steam function to make the self-cleaning function work, later turn off the power, and pipe water away.

1).Power off

For safety, it is strictly prohibited to open the lid of the easy cleaning cup during using. In order to avoid steam gas emits out and scald users, please shut down all other functions before using the steam generator  cleaning function. (As picture 11)

2).Open the easy cleaning cup

After Making sure all of functions are turned off, find out the cleaning cup according the right picture illustrated, and rotate the lid of the cleaning cup to the reverse direction, and then take the lid out slightly. (As picture12)



3).put the cleaning liquid

After opening the cleaning cup, use a spoon to take a proper amount of cleaning liquid, such as Citric acid, or neutral compound cleaning liquid (around 5 ml) to put in the cleaning cup. Note: If the cleaning material is solid, first, please dissolve it with water to prevent blocking.Strictly prohibit to use any other acid, alkaline compounds to be poured into the cleaning cup directly.(As picture13).



4).Cover the lid

After adding the cleaning liquid, cover the lid back and turn it in clockwise direction to fasten,like this can prevent the steam emitting out to scald users (As picture14).

5).Turn on and start the steam function

After covering the lid, press  to turn on the steam generator function, and the system  will begin to clean the steam box automatically.(As picture15)

6).Turn off the power and drain out the waste water

After 5-10 minutes, press the  to turn off the steam generator, then press the , the waste water will be drained out automatically(As picture16).



As picture 11



As picture 12



As picture 13



As picture 14



As picture 15



As picture 16

Notice:

1. Strictly prohibit to use the cleaning function while any other function is on;
 2. Strictly prohibit to use any other alkaline cleaning compound to clean steam generator;
 3. Strictly prohibit to use any solid cleaning agent to clean steam generator, in order to avoid blocking the pipe.
- We recommend that you use citric acid solution to clean steam generator!

Maintenance service card

Item number			
Serial number		Purchasing date	
Phone number			
<p>Eago guarantees to keep: Eago series' products in good repair against the maintenance service card and purchasing receipt since the purchasing date. If it is the product quality problem, it will be free maintenance or change the spare parts. If the problem is not caused by the products itself or over-exceed the one-year guarantee, it will charge the repairing fees and spare parts costs.</p>			

The first page is kept for the customer.

Maintenance service card

Item number	
Serial number	
Customer name	
Phone number	
Address	
Agent shop	
Phone number	
Purchasing date	

The second page is sent back to eago head office.

Maintenance service card	
Item number	
Serial number	
Customer name	
Phone number	
Address	
Agent shop	
Phone number	
Purchasing date	

Steam shower room trouble shooting

Malfunction Status	Reasons	Solutions
Small volume inlet water	<ol style="list-style-type: none"> 1. Lower inlet water pressure 2. The water inlet pipe is blocked 	<ol style="list-style-type: none"> 1. Check the inlet water pressure, then check with local plumber 2. Clean the filtre
Water divert valve can't divert water	<ol style="list-style-type: none"> 1. Rubber inside the valve damaged or distorted 	<ol style="list-style-type: none"> 1. Change a new one
No signal on the control panel	<ol style="list-style-type: none"> 1. There is no power in the user's house or the wire not connected well 2. Not switch the power on 3. The connecting wire for the control panel becomes loose 	<ol style="list-style-type: none"> 1. Need to wait the power on, connect wires in right way 2. Swtich on the power 3. Take it off and install it again, don't forget fasten it
There is steam signal on the control panle, but no steam comes out	<ol style="list-style-type: none"> 1. The Temperature limiter operate or the heater is broken 	<ol style="list-style-type: none"> 1. Ask help to qualified people
Chromatherapy light doesn't work	<ol style="list-style-type: none"> 1. The connecting wire blew out or the lamp holder loosen 2. Lamp pannel is broken 	<ol style="list-style-type: none"> 1. Change a new one or install it well again 2. Change a new one
Ventilator doesn't work	<ol style="list-style-type: none"> 1. The connecting wire is off 2. The fan blade gets stuck 3. The ventilation fan is broken 	<ol style="list-style-type: none"> 1. Reconnect it well 2. When the fan is on spur the blades slightly 3. Change a new one