



(VI) Telephone function (optional)

When the machine is turned on, the **TEL** icon will flicker on the panel if there is an incoming call; meanwhile, the speaker will play the ring tone. Touch the button  on the touch panel to answer the call, and the **TEL** icon will stop flickering. Touch the button  on the touch panel again to end the call.

(VII) Failure Alarm Code

This machine has autonomous failure detection function. When the failure is detected, the corresponding failure code will be displayed on the screen as

Failure Code	Failure Description	Countermeasure
E1	Communication failure of steamer cables	Inspect whether poor contact of the steamer Cables occurs
E2	Inlet valve failure	Inspect the inlet valve and the connecting wires.
E3	Drain valve failure	Inspect the drain valve and the connecting wires.
E4	Failure of water inlet or drainage of steamer	Inspect the driving chip of the water inlet or drainage valve.
E5	Water inlet failure of steamer	Inspect whether water failure occurs.
E6	Temperature probe failure	Inspect whether the probe wires are damaged or poorly contacted.

IV. Technical Parameters

Operation Conditions and Characteristics			
Rated voltage	AC 220V	Rated frequency	50Hz-60Hz
Rated current	13.8A	Rated power	3050W
Insulated resistor	>20M	Current leakage	As per the enterprise product inspection standard
Waterproof level	IPX5	Current leakage protection	(15-30)mA

Load Configuration Parameters

Load type	Rated load voltage	Rated load frequency	Rated load power	QTY
Steam	Ac 220V	50Hz/60Hz	3kW	1
Ceiling lamp	Ac 12V	50Hz/60Hz	25W	1
Background lamp	Ac 12V	50Hz/60Hz	5W	1
Ozone disinfection	Ac 12V	50Hz/60Hz	5W	1
Fan	Dc 12V	-----	3W	1
Electromagnetic valve <small>Note1</small>	Dc 12V	-----	5W	2
Speaker	-----	-----	8/10W	1



Do not dispose this product as unsorted municipal waste. Collection of such waste separately for special treatment is necessary.

INSTALL DIRECTION

STEAM BATHROOM

MODEL : WS-802L



Sanitary Ware Expert,
Your best choice!

TECHNIQUE PARAMETER

Voltage	Frequency	Water Volatge	Power of steam generator
AC220V (±10%)	50/60Hz	0.1~0.2Mpa	3KW

CONSTRUCTION SKETCH

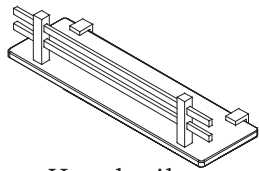

Handrail

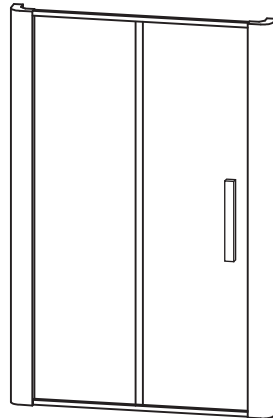

Glass door



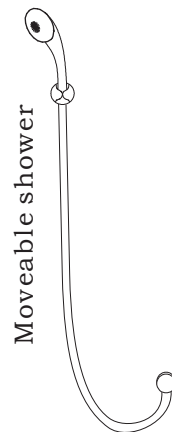

SIZE:1150X870X2150mm



Moveable shower

(II) Alarm function

when the machine is turned on , touch the button  3seconds on the panel to turn on alarm function, the screen showing **505** ,meanwhile ,turn off steam function and radio function , and turn on fan function and lamp function .The speaker will be sound the alarm .After touch the button  turn off the alarm will relief the alarm.

(II) Lamp function





When the machine is turned on, touch the button  on the touch panel to turn on/off the ceiling lamp.

(III) Fan function

When the machine is turned on, touch the button  on the touch panel to turn on/off the fan. When the fan is turned on, the fan indicate will illuminate simultaneously.

(IV) Radio function

1、 When the machine is turned on, touch the button  on the touch panel to turn on/off the radio function. When the radio function is turned on, the radio frequency will be displayed on the screen, such as **102.7** ^{Mhz} .



2、 Touch the button  on the touch panel to go to the frequency tuning mode, and the **Mhz** icon will flicker on the screen. Press the button  or  to tune the radio frequency. Touch and hold the button  to store the current frequency, and the currently stored frequency channel will be displayed on the screen, such as **3ch** .

3、 When the radio is turned on, touch the button  to swap the frequency channels, and the range of frequency channels is from 1 to 8.



4、 Under the radio status, touch the button  on the touch panel to go to the volume adjustment mode, and the range of adjustment is from 1 to 15, and the volume will be displayed on the screen during adjustment, such as **10db** .

(V) Steam function

1、 When the machine is turned on, touch the button  on the touch panel to turn on/off the steam function. When the steam function is started, the steam function indicator will illuminate. After the steam function is enabled, the default set time for steam is 45 minutes, and the default temperature is 100F.

2、 When the steam function is started, touch the button  on the touch panel to go to the steam setting mode. If the **Min** icon flickers on the screen, such as **45** ^{min} , it enters the steam time setting status, and the number displayed is the remaining time for steam operation. Touch the button  again to swap to the steam temperature setting status, and the **°F** icon flickers on the screen, such as **90** ^{°F} , and the number displayed is the steam temperature setting value.

I. Instructions

1. Capacitor touch buttons are adopted in this panel. In selecting the position to install the panel, we should avoid facing directly the spray and shower nozzle, otherwise it may lead to mistaken operation of the panel or locking the panel;
2. The location area of each function button on the panel is the optimum touch range;
3. The panel is optimized with waterproof function. When mistaken operation is tested (with two or more keys touched simultaneously), there will be no response. Wait for about 1 second to restore operation.
4. Under the status of panel locking, the system gives no response when touching the panel, and the  icon flickers on the LCD. At this time, touch the  key for two seconds, and the locking will be released. Meanwhile, the  icon goes off on the LCD, and you can operate the keys on the panel.
5. When touching any key on the panel, the operating system will give a “beep” tone if the system operation is enabled.

II. Introduction to Functions

- 1.Lamp function; 2.Fan function; 3.Steam function;
- 4.Radio function 5.Telephone function; 6.Failure code indication;
- 7.Ozone disinfection after turning off; 8.Alarm function

III. Method of Operation

(I) Turn on/off the machine

1. Standby mode

The system is in standby mode after power on, and a red dot will be displayed on the screen to indicate connected power.

2. Turn on the machine

When the system is in standby mode, touch and hold the button  for two seconds to start the machine and the current temperature will be displayed on the screen, such as **25 °C** . At the same time, the ceiling lamp will light up. When the machine is started, it is timed for 60 minutes and the machine will shut off automatically when the time is due.

3. Turn off the machine

Either the button  on the touch panel is touched or the default set time (60 minutes) is up, the machine will be turned off, and all the activated functions will be disenabled, and the system will go back to the standby mode. After the system is turned off for 30 seconds, the automatic water discharge function will be started automatically.

CONSTRUCTION SKETCH

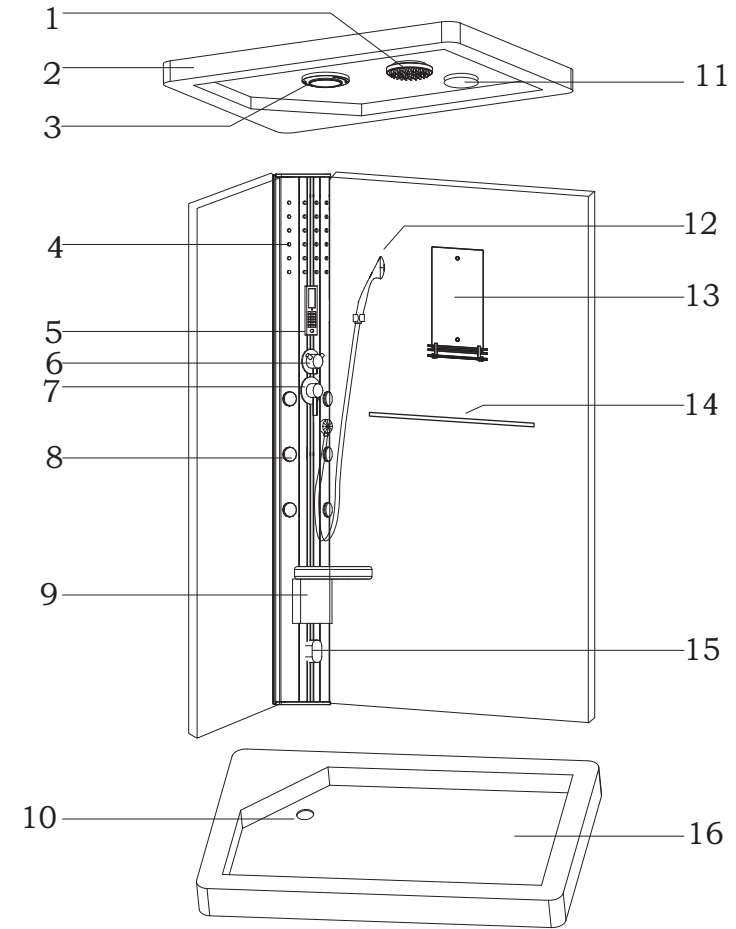

- | | | |
|-------------------------|--------------------|----------------|
| 1.top shower | 8.nozzle | 15.steam out |
| 2.roof | 9.seat | 16.bottom tray |
| 3.speaker | 10.drainage | |
| 4.decorated light | 11.exhaust fan | |
| 5.control panel | 12.moveable shower | |
| 6.shift switch | 13.mirror | |
| 7.cold/hot water switch | 14.towel shelf | |

INSTALLATION SKETCH

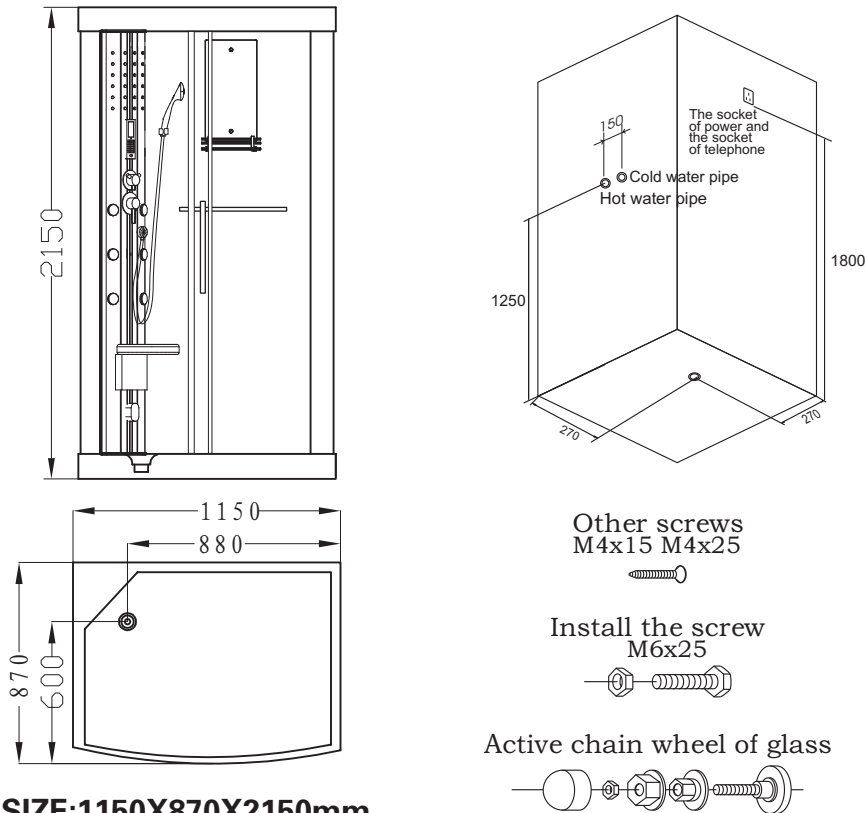

SIZE:1150X870X2150mm

ILLUSTRATION OF INSTALLATION

1. The products should be installed by technical guy who are got the certificate or those technical who are assign by dealers. The main power switch and electronic leakage device should be installed.
2. The plug of electronic should be installed above the steam generator and the length of electronic wire not less then 1800MM from the earth.
3. There are should be with main power switch for hot and cold water pipe of steam room and the water pipe should be connect to drainage water pipe.
4. Install the products according to the diagram of installation When fixed the place for the products.

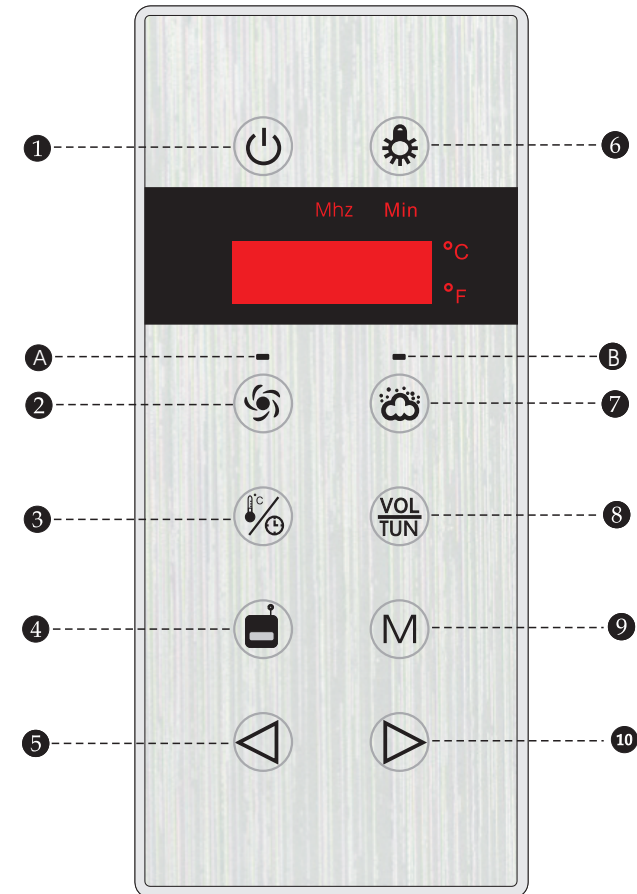

- | | |
|---|------------------------------------|
| 1、 On/Off function key | 6、 Lamp/Alarm function key |
| 2、 Fan function key | 7、 Steam function key |
| 3、 Steam adjustment function key | 8、 Radio tuning function key |
| 4、 Radio/Telephone receive function key | 9、 Radio memory key |
| 5、 Parameter setting decrease key | 10、 Parameter setting increase key |
| A、 Fan function indicator | B、 Steam function indicator |

DRAWING OF WATER CONNECTION

As the “” from the picture, please make the connection according to the serial number v1,v2,etc.

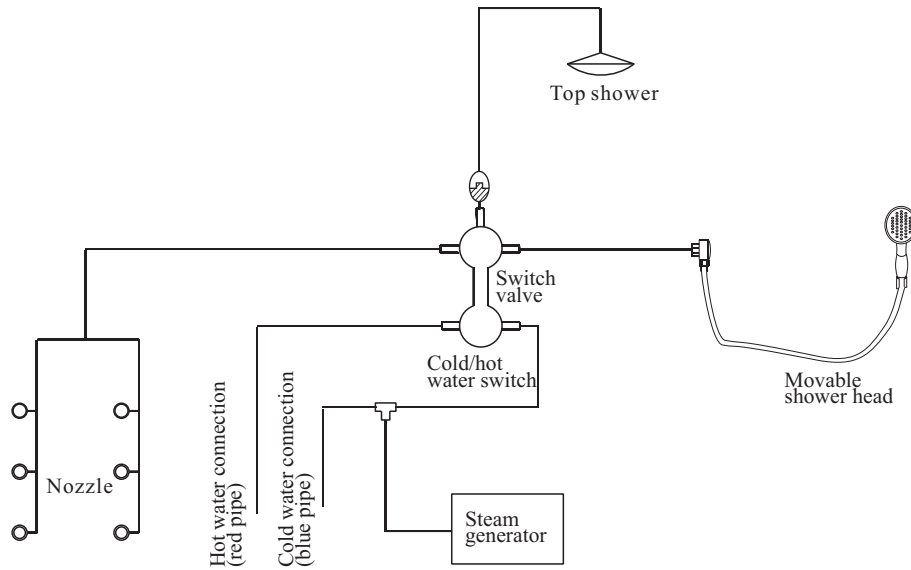

ELECTRIC CIRCUIT SKETCH

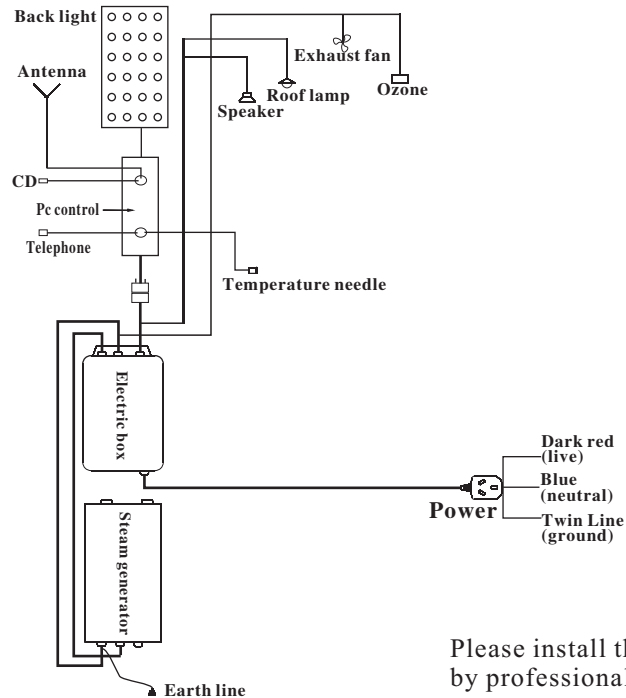

Please install the earth line safely by professional technician.

INSTALLATION PROCESS

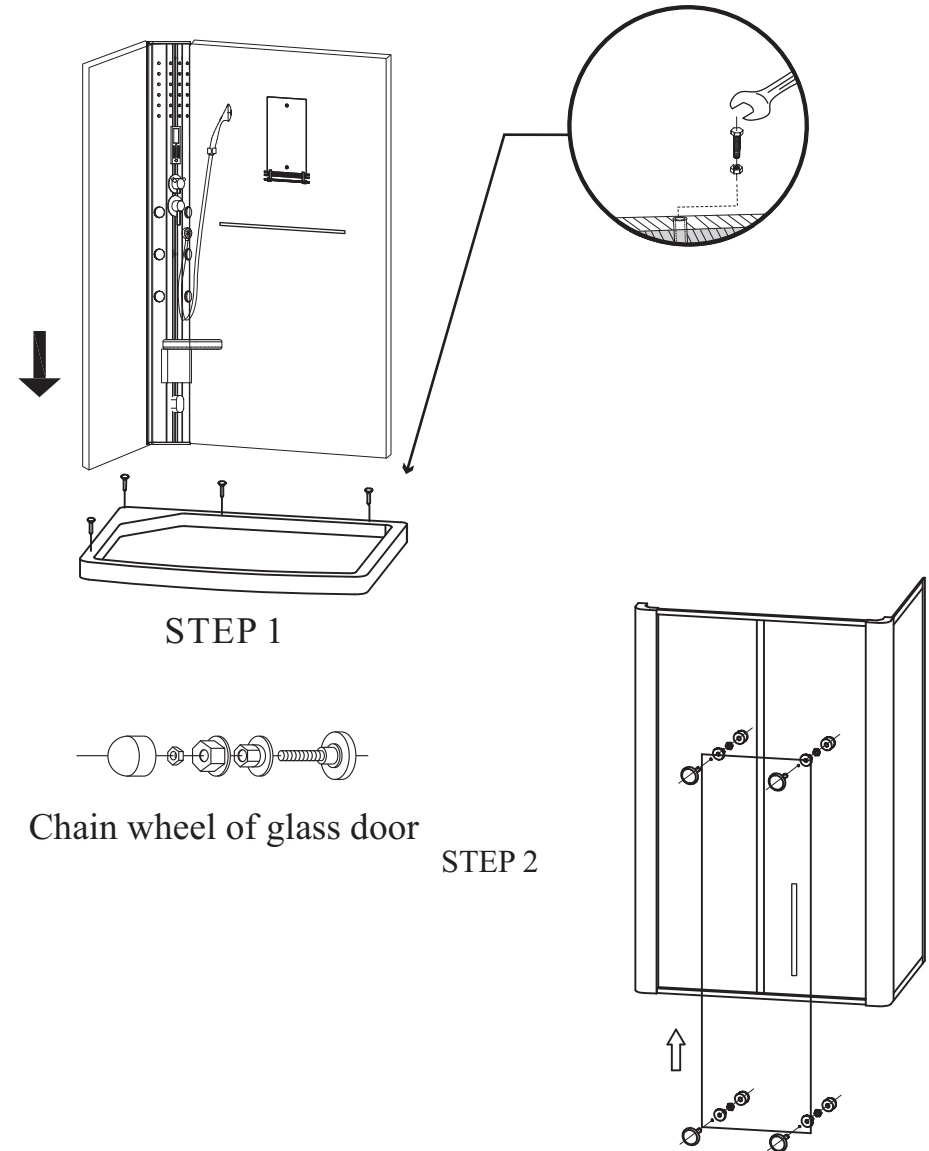

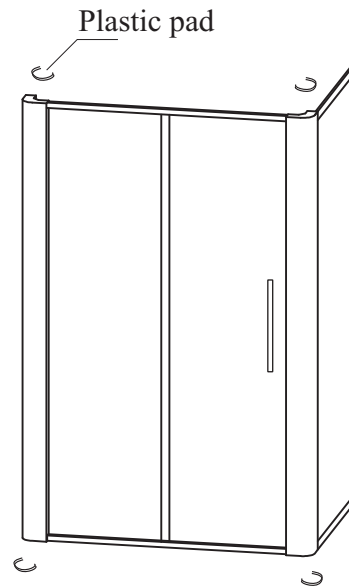

STEP 3

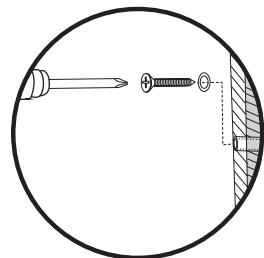

M4×15

STEP 4

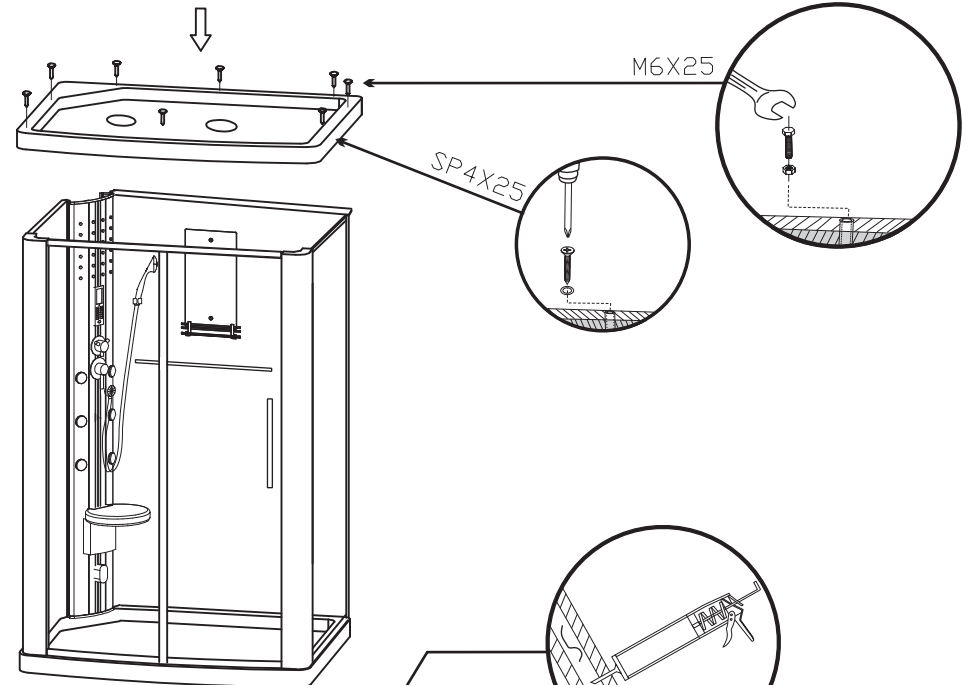

STEP 5

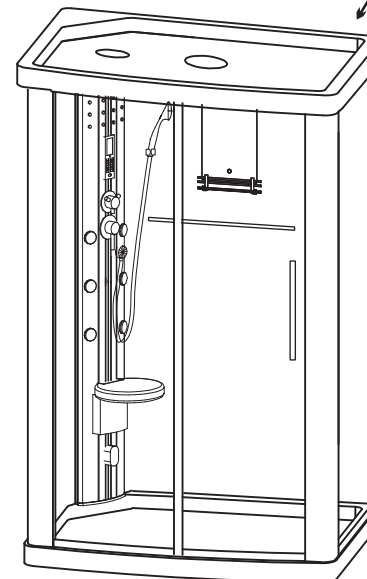
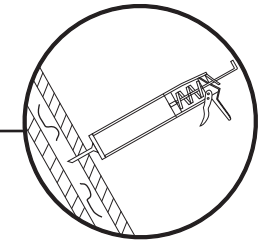

STEP 6