

● Drawing of water connection

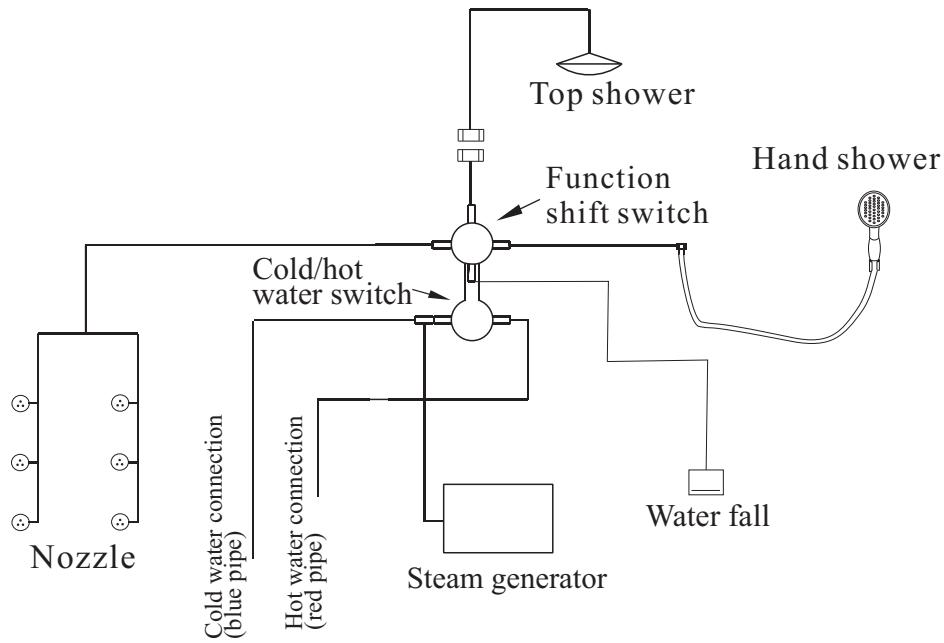

No advanced advice will be submit before we change our design and size.

The pictures may be a little different from the real products.

Our company keep the final explanation right.



Do not dispose this product as unsorted municipal waste. Collection of such waste separately for special treatment is necessary.



Install manual

Steam bathroom

MODEL : WS-609P



FOREWORD

• Welcome to purchase our steam bathroom. For use function of the unit well and dose not any trouble in using this product. For perfect operation and security, please read the manual carefully and keep it for the future reference. No further notice will be submitted if any changes in products. The explain property rights owned by our company if there is no any particular or mistake about it.

Identification of components

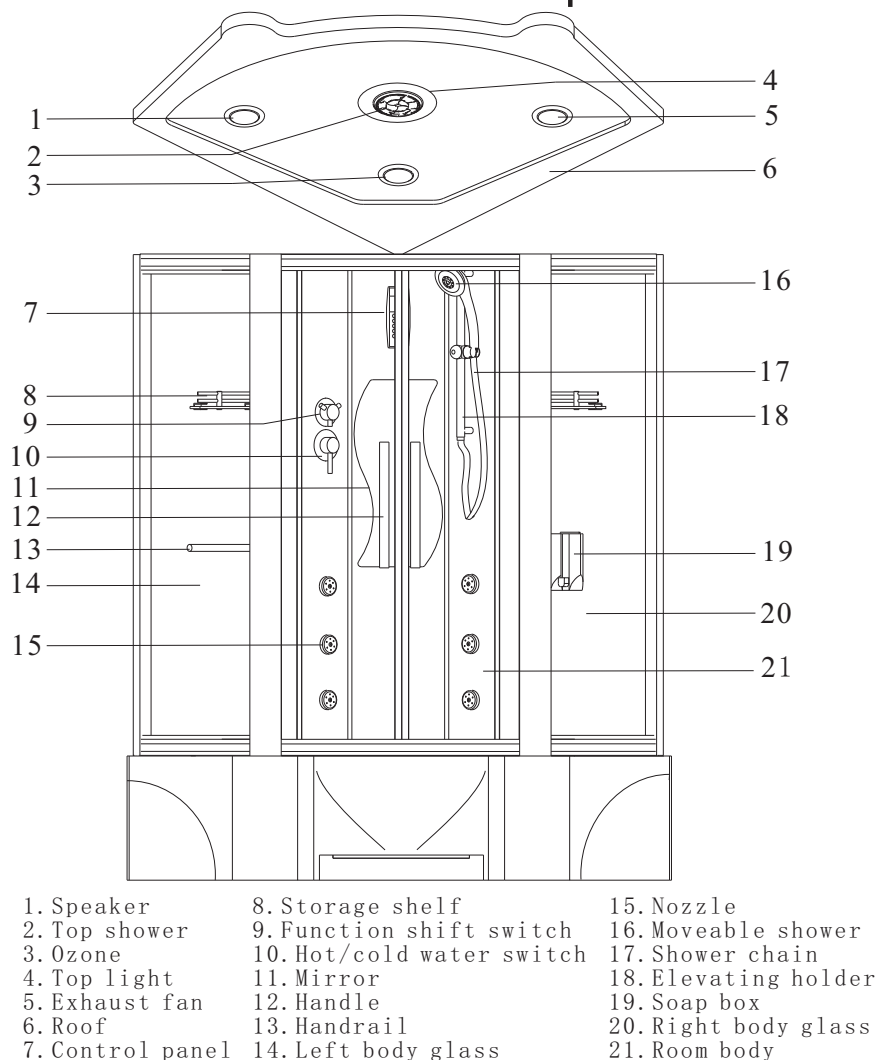

● TROUBLESHOOTING

Phenomenon	Reasons	Maintenance
Without steam	<ol style="list-style-type: none"> 1.steam generator without water. 2.inside infrared pipe burn out of steam generator. 3.block of steam spray mouth. 4.probe out off control. 5.the temperature inside steam room is over the temperature what were set. 6.after fill into water it is still not the time for steam working. 7.it is overtime for the setting time. 8.unconnect with the control wire. 	<ol style="list-style-type: none"> 1.check if the switch of water in be turn on or not. 2.change the infrared pipe. 3.get rid of mess. 4.check the connection wire and change the probe. 5.waiting decrease the temperature. 6.be waiting few minutes. 7.adjust the setting time. 8.connect to control wire.
Without O ₃	<ol style="list-style-type: none"> 1.system be damaged 	<ol style="list-style-type: none"> 1.change the system
Water pump unworking	<ol style="list-style-type: none"> 1.water pump without power. 2.air pipe which connect with switch of air valve be insected untightly. 3.switch of air valve out of control. 4.air pipe leaking. 5.rotor of water pump unworking. 6.water pump be burned. 	<ol style="list-style-type: none"> 1.check if the power of water pump get through. 2.to insect the air pipe tightly. 3.change the switch of air valve. 4.change the air pipes. 5.check if there are stems in the water pump,take apart those air pipes in order to get rid of stems. 6.change the water pump.
Volume under control	<ol style="list-style-type: none"> 1.suction of water pump is not enough. 2.air adjustment valve working abnormal. 3.block of jets. 	<ol style="list-style-type: none"> 1.check the water pump if it is working normally. 2.change the air valve. 3.get rid of mess.
Water pipe leaking	<ol style="list-style-type: none"> 1.plastic seal ring be connected untightly. 2.screws unlock. 3.connection is glued not good. 4.water pipe be damaged. 	<ol style="list-style-type: none"> 1.change the plastic seal ring. 2.screws should be installed tightly. 3.get rid of the PVC glue then stick the glue again till it is be well done. 4.change the water pipe.
Computer panel under control	<ol style="list-style-type: none"> 1.power not be connected well,electronic leakage device without power. 2.switch of control panel out of control. 	<ol style="list-style-type: none"> 1.get through the power again. 2.change the computer panel.
Without lighting	<ol style="list-style-type: none"> 1.bulb be burned. 2.without power. 3.switch of control panel out of control. 	<ol style="list-style-type: none"> 1.change bulb. 2.get through power gain. 3.maintain or change the computer panel.
Telephone connection unworking	<ol style="list-style-type: none"> 1.telephone wire not connected well or be damaged. 2.telephone's device be blocked. 	<ol style="list-style-type: none"> 1.check the wires of telephone and electronic box if get through or not, if there is something wrong replace by the similar wires. 2.get rid of mess.
Without sounds	<ol style="list-style-type: none"> 1.speaker be broken 2.without power 3.switch of control panel out of control 	<ol style="list-style-type: none"> 1.change the speaker 2.get through power again 3.maintain or change the computer panel

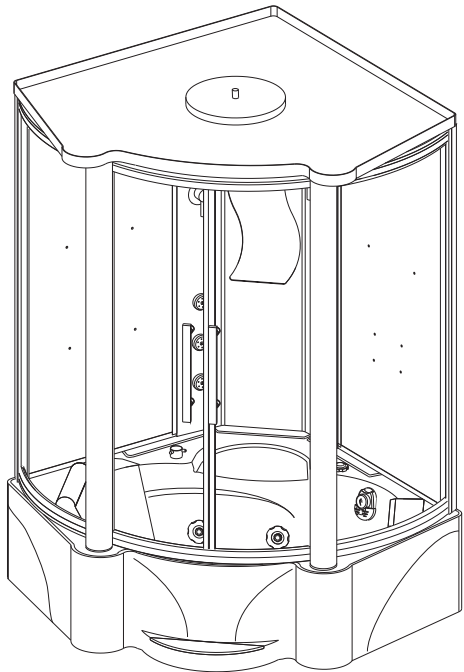

Step 6

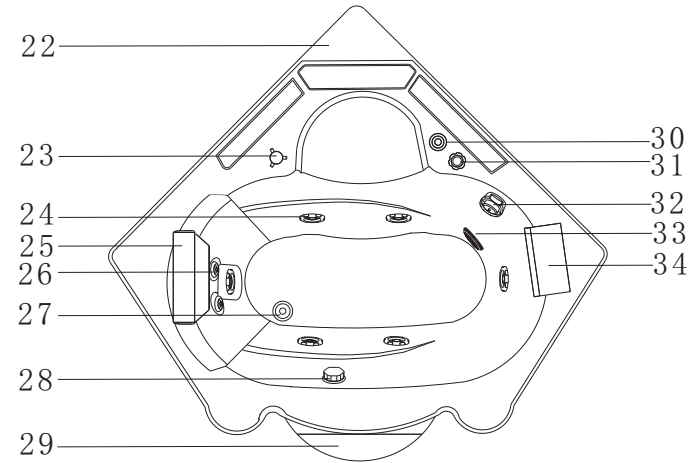
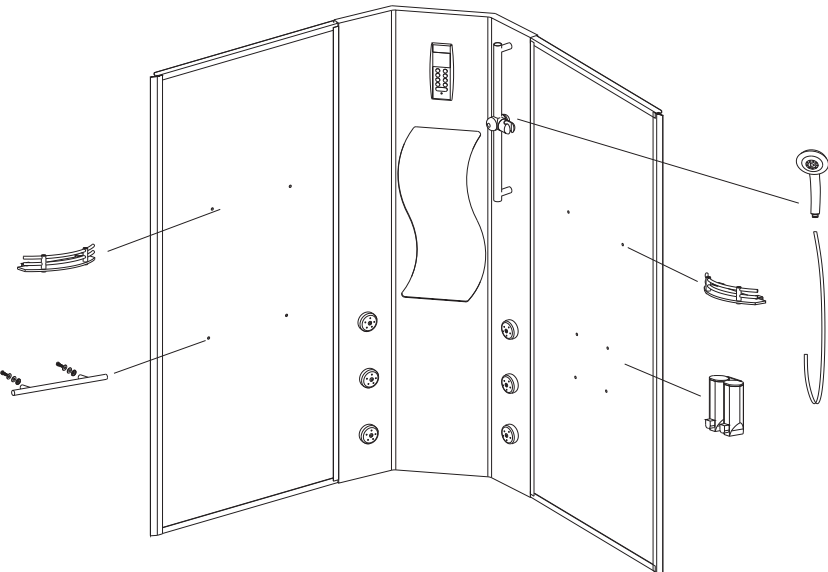

- | | |
|---------------------|------------------|
| 22. Bathtub | 29. Marble |
| 23. switch | 30. Air switch |
| 24. Water jet | 31. Air adjuster |
| 25. Pillow | 32. Steam outlet |
| 26. Nozzle | 33. water inlet |
| 27. Drainage | 34. Waterfall |
| 28. Drainage switch | |

● Notes

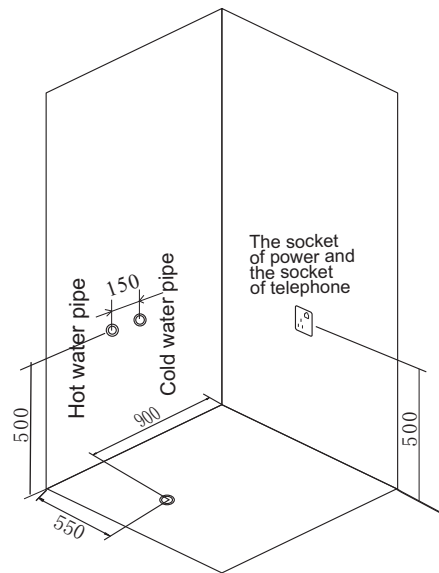

1. Install the steam bathroom in a proper way and have the electrician or professional personnel to install the unit, the company won't take the responsibility for any improper installation and usage.

2. The application of the product shall observe the operating instructions, dismantling and alteration without authorization is prohibited, the manufacturer shall not take the responsibility for any problems resulted from improper use or dismantling by one's self.

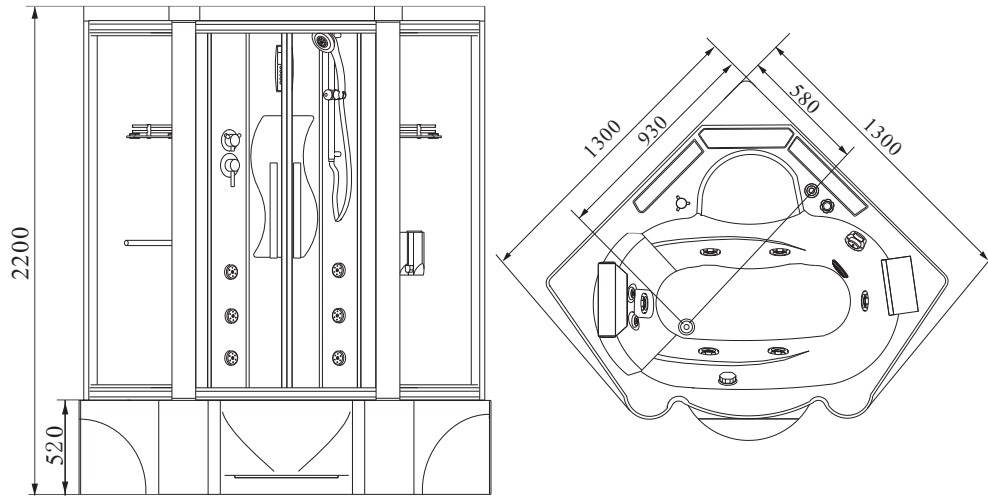

● Please follow the steps to install the unit.

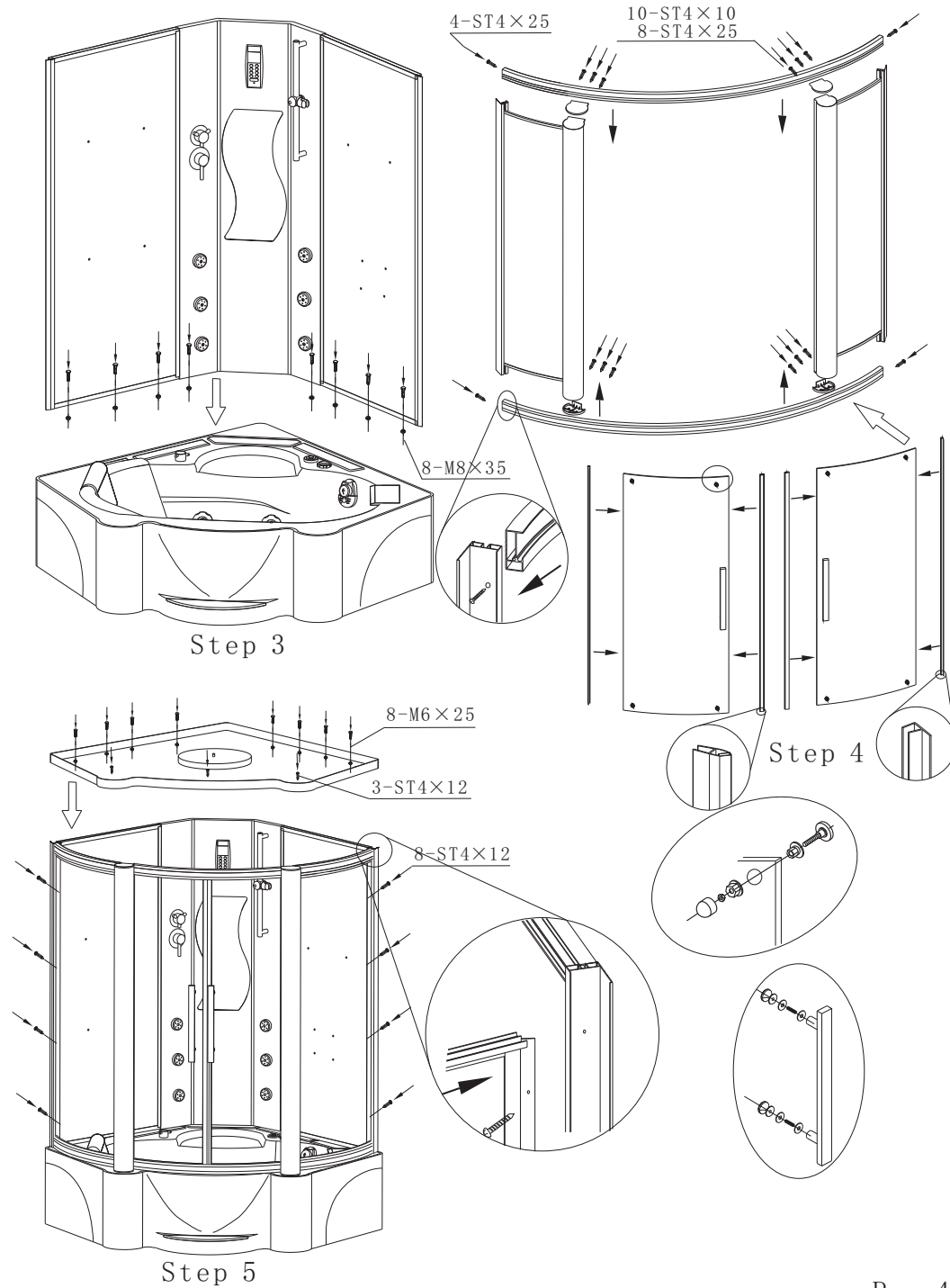
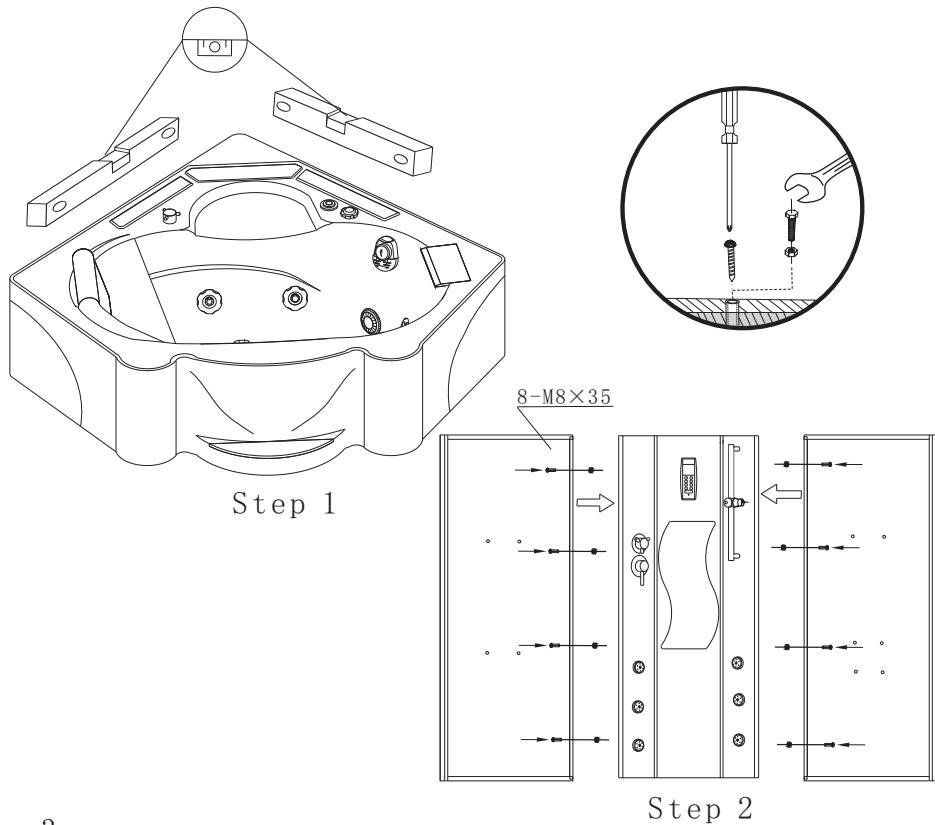

THE SENIOR COMPUTER STEAM
ROOM CONTROL SYSTEM



MODEL:GD-6001

PRECAUTIONS:

1. Qualified technician is required to install the system. The leakage protection switch should be installed in the place convenient for controlling.
2. The system should be installed steadily to the ground, or the factory should not be responsible for the loss of the consequence!
3. The steam engine should be vertically and steadily installed. The Output of steam can NOT be blocked and NO valve should be installed there!
4. Please disconnect the main power switch if the unit is not used for a long time Under Standby mode.
5. The load of power supply circuit should be considered when installing, or it may influence the normal performance of the system, or for worst it may lead to accidents!

MAINTENANCE:

1. For malfunction can not be solved through the ways mentioned above, please consult to qualified maintenance man or contact the supplier.
2. Please disconnect the main power switch if the unit is not used for a long time so that not to leave the unit under standby mode for too long.
3. It is recommended to clean the steam engine 3 months once to clean out sediment inside the water tank especially in the area of hard water.
4. The following cleaning method is suggested: dilute 5 to 10g citric acid with 1.4 litre warm water, disconnect the pipe of the output of steam generator and in pour in the diluted water, then

Re-connect the pipe. 60 minutes later, start the unit and heat up for 30 minutes and discharge the water inside.

SYSTEM INSTALL SKETCH

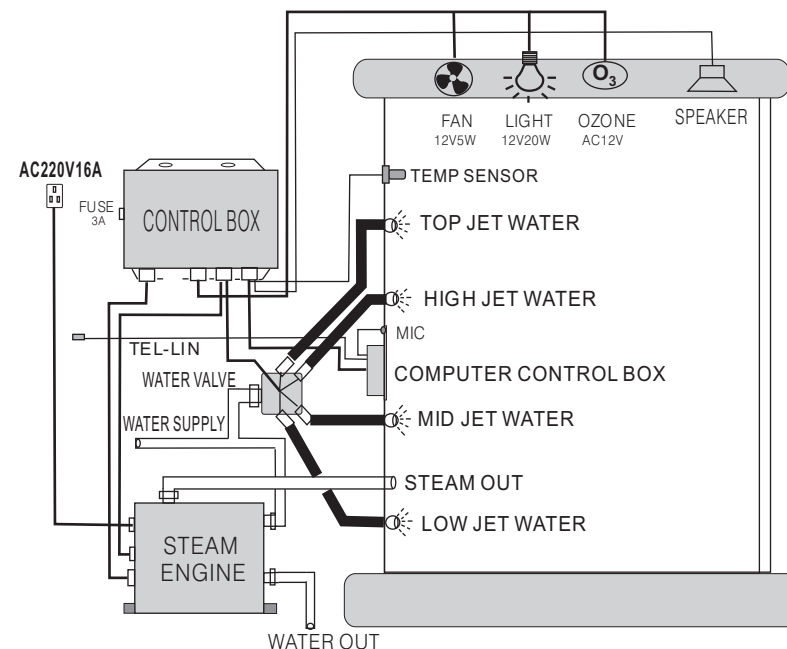

GD-6001

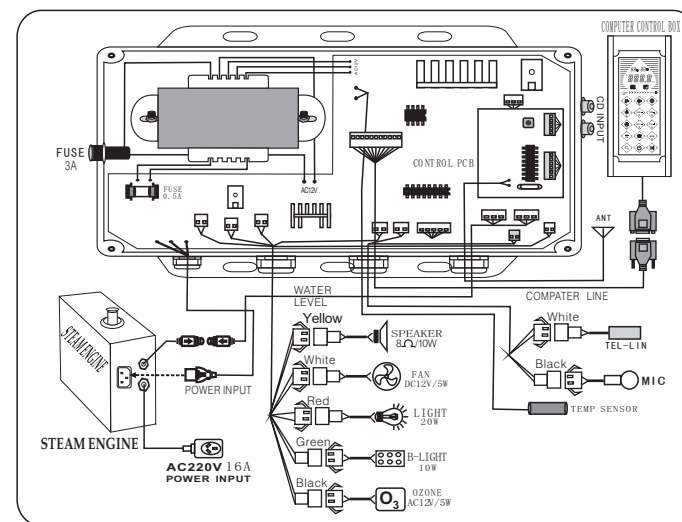

PANEL FUNCTION DESCRIPTION

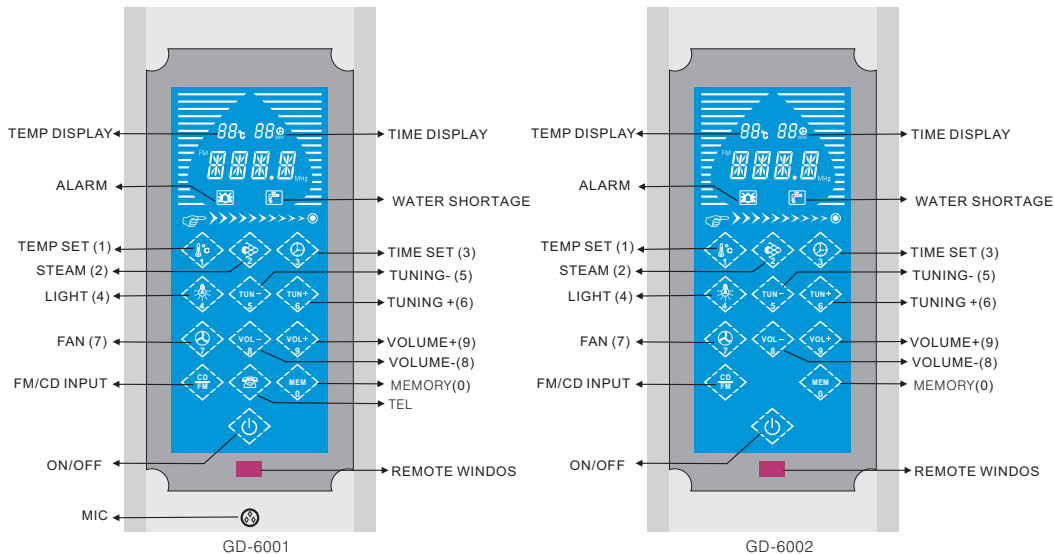
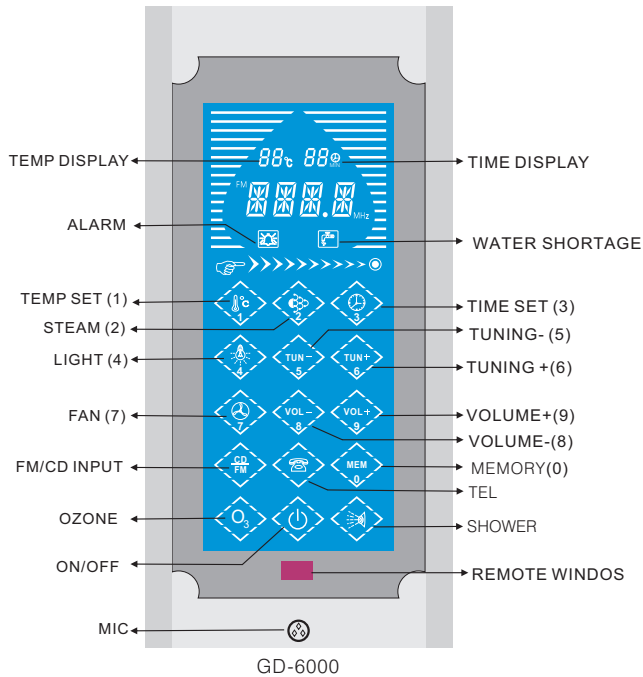

4. Shutdown



Press the () key to shut down all functions, when the screen indicates (OFF). After 1 minute, open the drain valve of the steam engine for drainage, which will last 2 minutes. Then the screen goes out and the whole unit enters the standby mode. If the unit is not to be used for a long time, please disconnect the main power switch.

TECHNICAL PARAMETERS

- Voltage : AC190V - 240V 50Hz--60Hz**
- STEAM POWER: 3-4.5kw**
- LIGHT POWER: LIGHT1 AC12V/20W OR AC220V/32W
LIGHT2: AC12V/10W**
- FAN POWER: DC12V/5W**
- Water valve power: AC12V/6WX4**
- OZONE POWER: AC12V/5W**
- Speaker 8  10W**
- TEMP SET : 20-60°C**
- TIME SET : 1-60MIN**



3. Radio Section

(1) Press () key , the screen will indicate the radio frequency with the indication of music volume dB changes from low to high, then the frequency spectrum will flash with music.

(2) Press the ( or ) key for upward tuning, flashing dots for manual tuning. If the key is held for over 2 seconds, the frequency will fluctuate upward until a station is found. In the case of poor receiving environment or weak signal, it is suggested to tune manually. Press the () key when a radio station is selected, the screen will indicate (ch--) in English, when the radio tuning key must be pressed again to store the just selected station in it and the screen indicates (ch1-ch10) corresponding to the station position. If the received signal is not so ideal, unfold the antenna and adjust its orientation or position.



(3) To listen to the stored radio station, press () + ([0-9]) to select the corresponding station which indicated in the screen as 1-10. The radio frequency in the man-machine conversation area, you can choose the station you like.

(4) Volume control:

Press the volume () or () to get the desired volume, the corresponding DB will be indicated in the screen.

(5) Exter CD:



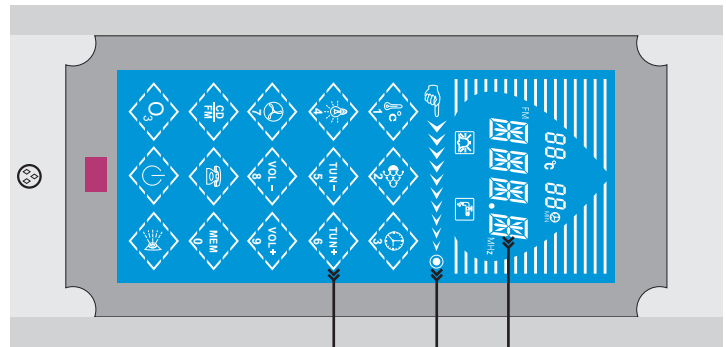
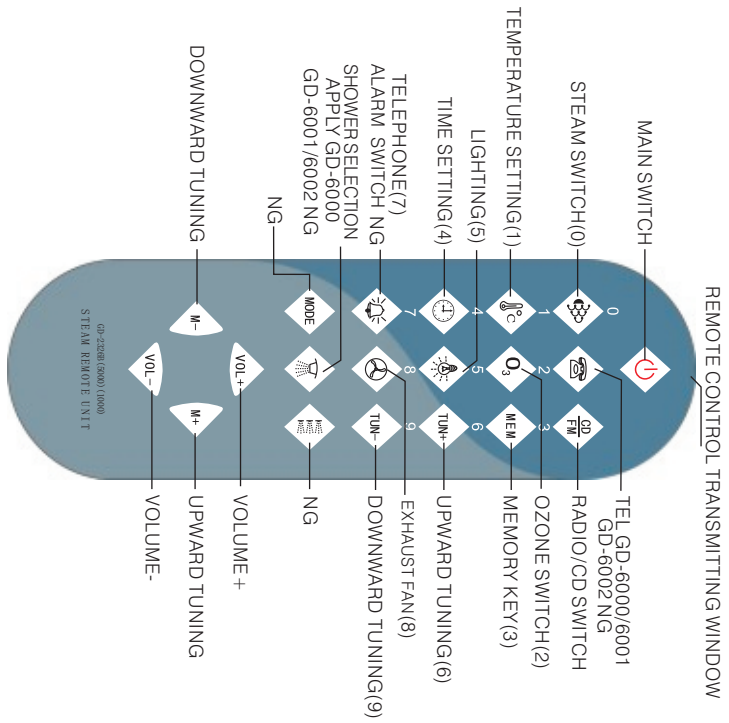

Connect the CD audio wire with the external Faucet of the main control box,

Press () key to the position of CD, then choose the suitable volume by pressing () or () to listen.





1、 Be touching the key touch inside, After switch on electricity the LCD manifestation will order bright, the area once, Press () key within the scope of the system, seconds will open. At this time can according to you of the demand carry on an operation.



2、 Steam function:

- (1). Press ()key ,the is turned on, press again () key to OFF.
- (2). Press ()key ,the is temp set, set scope 20 -60 °c , **system set is 50 °c.**
- (3). Press ()key ,the is time set, set scope 1 -60min , **system set is 60min.** ending in fixed time will close steam function auto off.

NOTE:

if the lcd display, While using steam (E1-E3), !please watch for

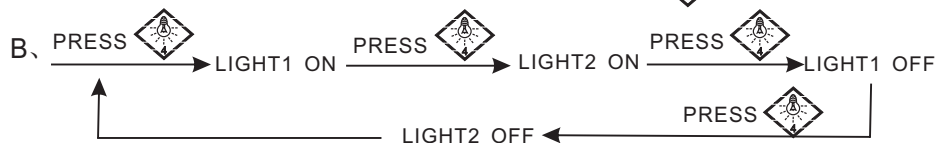

- (E1 )---Mean to have no water Will close steam function auto to off minute\ for .
- (E2  )---Mean to have no water protection Will close steam function auto to off for 30 Second.
- (E3)---Super temperature

(4). **light function:** A、 Press ()key ,the light1 is turned on, press again () key to OFF.

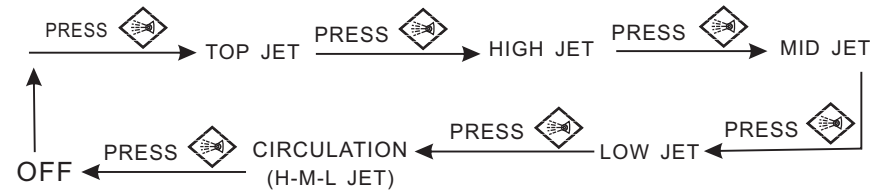

(5).**sprinkling function:** press the sprinkling selection button to select (sprinkle top-sprinkle high-sprinkle mid-sprinkle low -sprinkle Circulation-sprinkle-off,sprinkling function apply GD-6000 NOTE: GD-6001/GD-6002 NG



(6). **OZONE function:** Press ()key ,the ozone is turned on, press again () key to OFF.

NOTE: ozone run minutes \ · time is auto off.

(7). **FAN function:** Press ()key ,the FAN is turned on, press again () key to OFF.

(8).Telephone function:

In the case of an incoming call under radio mode, the radio sound is Shut down automatically, the speaker rings and the screen indicates (TEL). Press the Telephone button to illuminate the telephone sign on the screen for talking. After finishing, press the () key again to hang up, when the radio broadcast is restored and the screen indicates the radiofrequency. To dial out under radio mode, press Telephone button and dial the number expected. Press again the Telephone button to hang up after finishing ,when the radio broadcast is restored.