



Part number 1898-7026-01 (403279)

2018 Ford Mustang

RTR Rear Diffuser

***Fits GT models with Quad exhaust tips only**

Component Identification

- | | |
|----------------------------------|---|
| 1. Rear Diffuser, Right | 1 |
| 2. Rear Diffuser, Left | 1 |
| 3. Diffuser Bracket | 2 |
| 4. 5mm x 10mm Short Screw | 4 |
| 5. 5mm x 20mm Long Screw | 2 |
| 6. 5mm Washer | 4 |
| 7. Adhesion Promoter (not shown) | 1 |

NOTE: In addition to common hand tools, this installation requires the use of an Air Reciprocating Saw and a Double Cut, Flat File or equivalent.

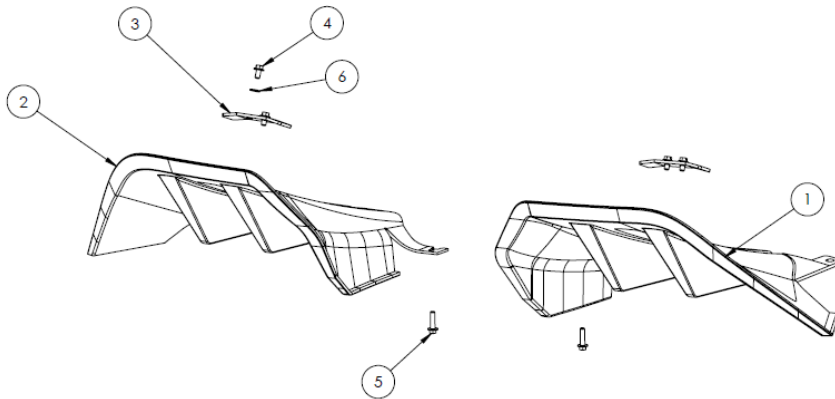

1. Installation of this RTR Rear Diffuser involves permanent modification to the OEM valance. Please read through these installation instructions in their entirety before beginning the installation.

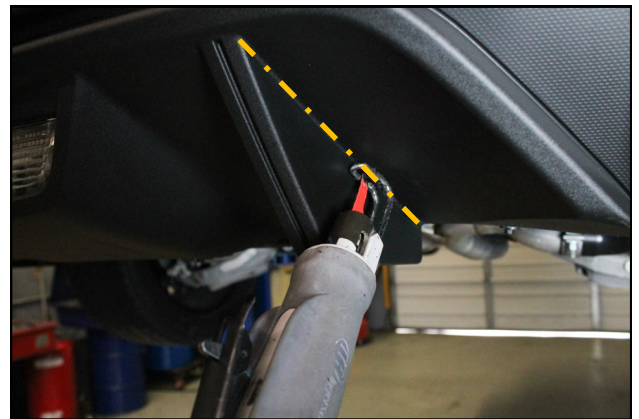

2. Using low to medium speed, so as not to melt the plastic, use an air reciprocating saw to cut out the OEM fins. Cut along the inside corner where the fin meets the valance.

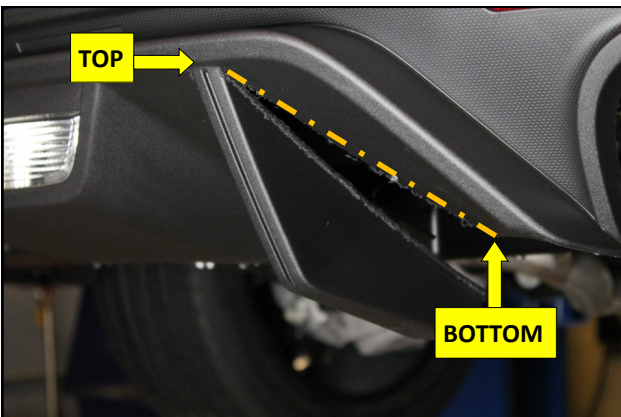

3. Cut along the length of the fin, from the bottom to the top, on each side of the fin.



4. Make the final cut across the top, to remove the OEM fin. Repeat Steps 2-4 on the opposite side of the vehicle.

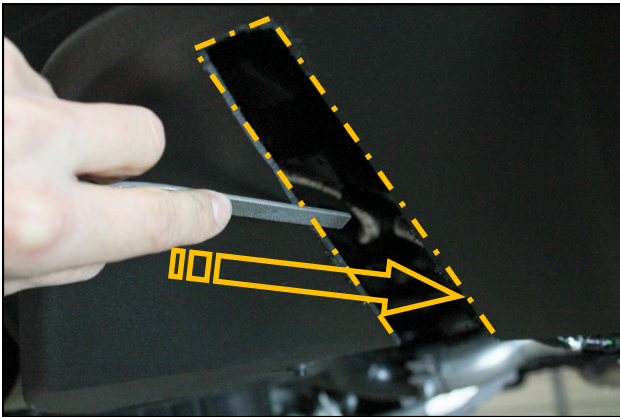

5. Using a file, deburr the edges of the cuts so the RTR Rear Diffuser will sit flat against the surface.



6. Prepare the valance by thoroughly cleaning with a mild soap and water solution.

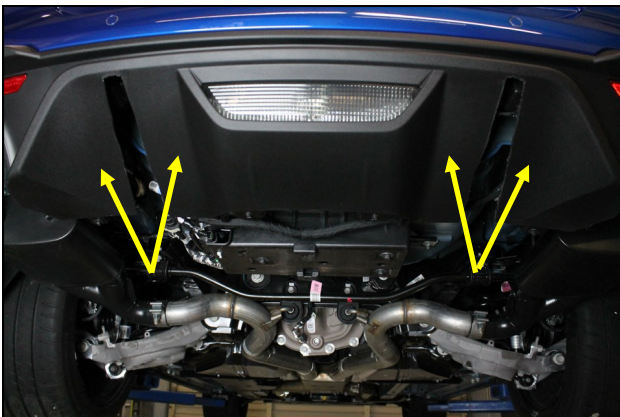

7. Hold up the RTR Rear Diffusers to identify tape locations, then apply the supplied Adhesion Promoter in tape locations.

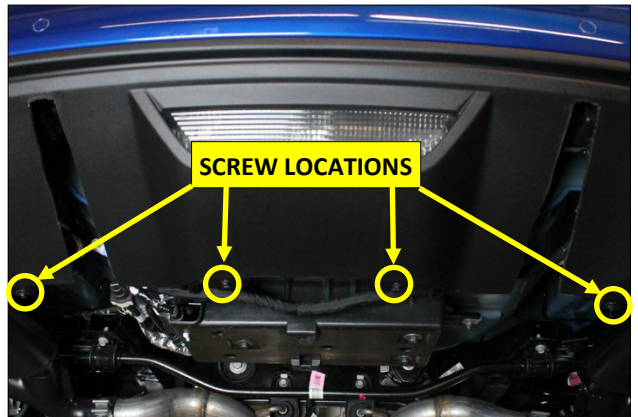

8. Using a 7mm socket, remove the four screws at the bottom edge of the valance and set them aside. The outer screws will be reused.

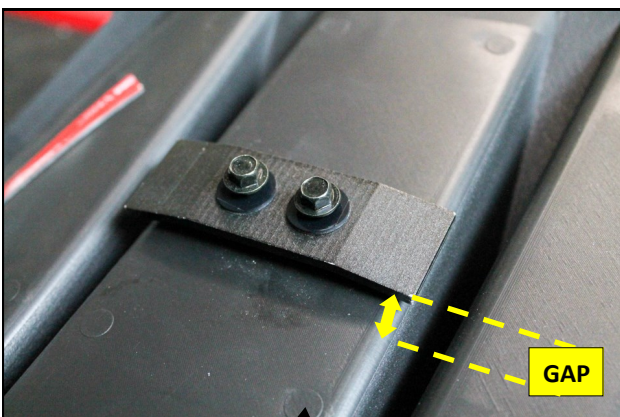

9. Loosely install the Bracket onto the RTR Rear Diffuser using two 5mm x 10mm Short Screws and Washers. Hand tighten the screws leaving an air gap, equal to or greater than the thickness of the valance.



10. Remove the backing from the Double Sided Tape. The RTR Rear Diffuser is now ready for installation onto the vehicle.

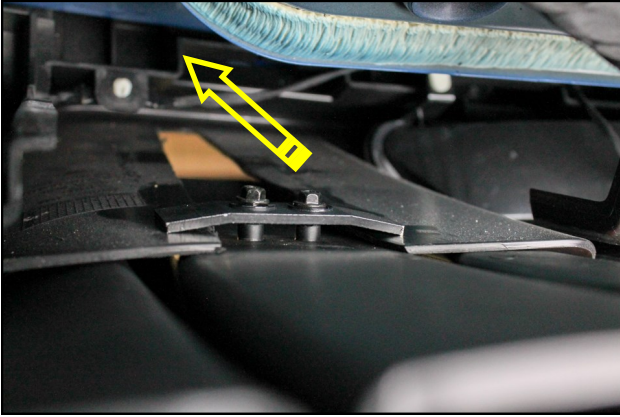

11. Slide the Diffuser up from the bottom, capturing the rear valance with the Bracket. Hold the adhesive surface away from the valance until properly aligned.



12. Slide the Diffuser into its final position. Do not press the adhesive until the screws are installed.

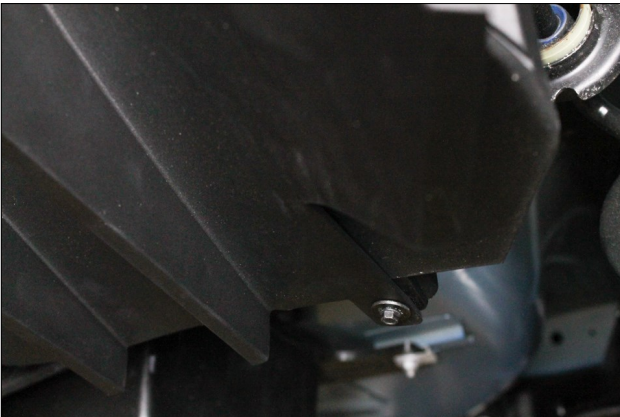

13. Reinstall the OEM 4mm Screw into the outside position, near the exhaust tip.

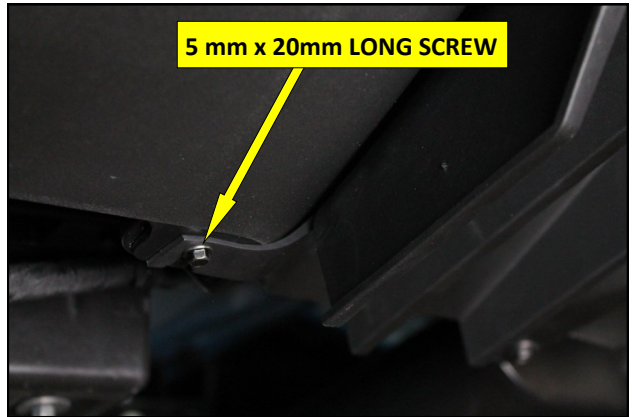

14. Install the 5mm x 20mm Long Screw into the inner position towards the centerline of the vehicle.



15. Repeat steps 9-14 on the opposite side of the vehicle.

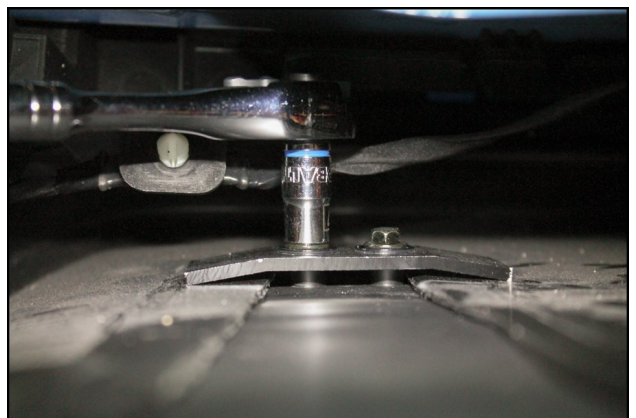

16. Tighten the 5mm x 10mm Short Screws inside the valance on the Left and Right side of the vehicle. Do not over tighten.



17. Press the double sided tape against the rear valance to complete the installation.