

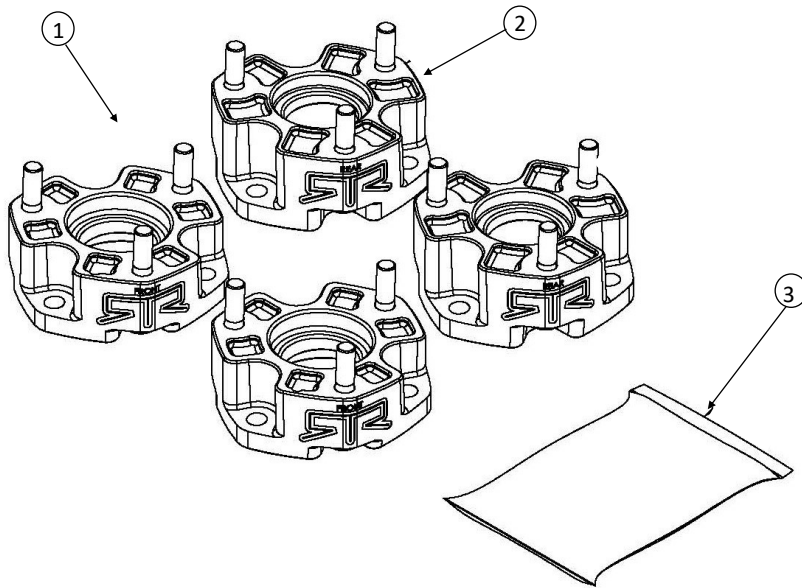

**2021-22 Ford Bronco  
RTR 2" Spacer Lift for  
Hitachi shocks (Black)  
Part Number 14081.001.86.A**



**Components Included**

- |    |               |   |
|----|---------------|---|
| 1. | Front Spacer  | 2 |
| 2. | Rear Spacer   | 2 |
| 3. | Hardware Pack | 1 |

In addition to common hand tools, RTR Strongly recommends the use of a professional wall or pedestal mounted spring compressor to safely complete this installation.



# WARNING



PLEASE READ THE INSTALLATION INSTRUCTIONS IN THEIR ENTIRETY BEFORE BEGINNING THE INSTALLATION. RTR RECOMMENDS HAVING THIS INSTALLATION PERFORMED BY A CERTIFIED PROFESSIONAL MECHANIC WITH ACCESS TO THE FACTORY SERVICE INFORMATION. RTR VEHICLES IS NOT RESPONSIBLE FOR ANY DAMAGE OR FAILURE RESULTING FROM AN IMPROPER INSTALLATION. IMPROPER USE OF THIS PRODUCT COULD LEAD TO PERSONAL INJURY AND IN SOME CASES, DEATH.

Suspension systems and components that enhance the off-road performance of your vehicle can cause it to handle differently than a stock vehicle. Extreme care must be used to prevent loss of control or vehicle rollover during abrupt maneuvers. Failure to drive safely may result in serious injury or death to driver and passengers. Avoid quick sharp turns and other sudden maneuvers. RTR does not recommend the combined use of suspension lifts, body lifts, or other lifting devices.

Constant maintenance is required to keep your vehicle in a safe condition. Thoroughly inspect your vehicle before and after every off-road use. It is the responsibility of the installer and vehicle owner to review all state and local laws related to bumper height and the lifting of their vehicle before the purchase and installation of this RTR product.

RTR reserves the right to make changes in Product design or specifications at any time without providing prior notice to the Retailer or the Customer.

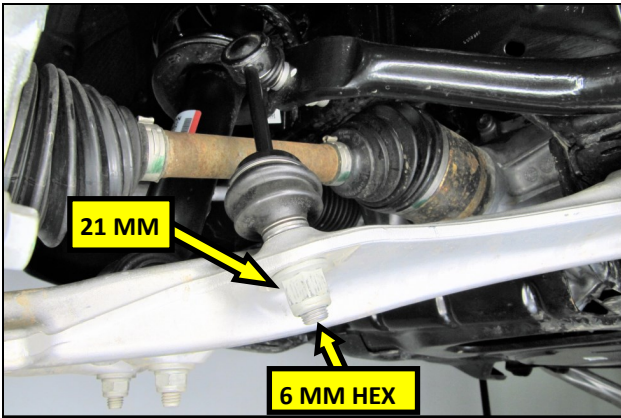

**1. FRONT SPACERS** With the vehicle safely suspended using a hoist or Jack stands, remove the wheels and tires. Using a 21 mm wrench and a 6 mm hex socket, disconnect the sway bar links from both the Left and Right side control arms.

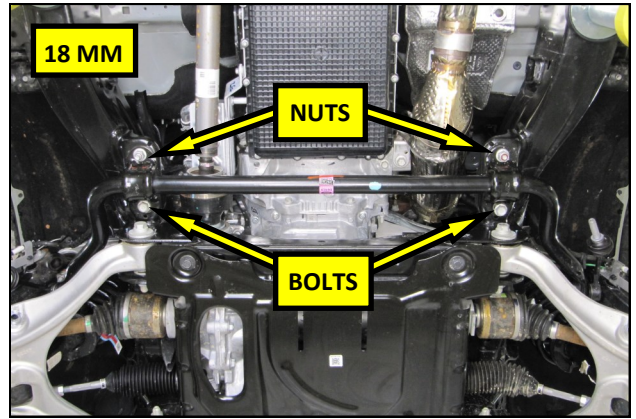

**2.** Using an 18 mm socket, remove the sway bar bracket hardware. With the help of an assistant, remove the sway bar and links from the vehicle and set it aside.

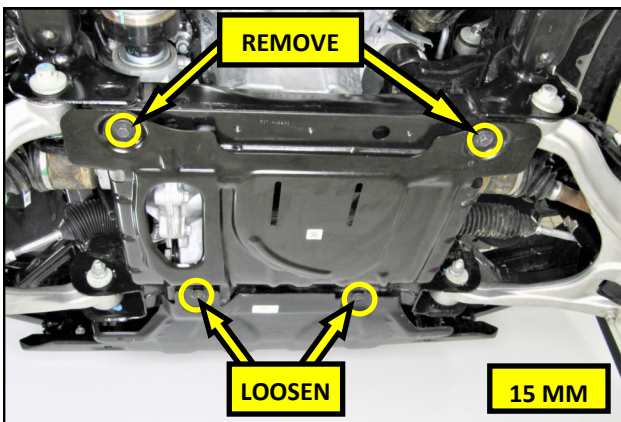

**3.** Using a 15 mm socket, loosen the two forward bolts in the differential skid plate and remove the two rear bolts. Remove the skid plate and set it aside.

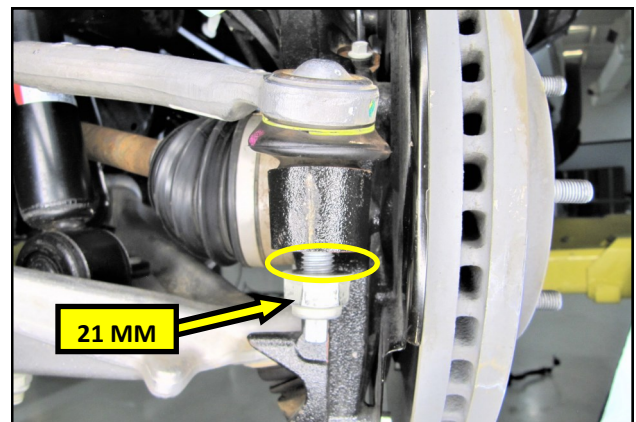

**4.** Turn the knuckle outward to full lock. Using a 21 mm socket, loosen but do not remove the tie rod end nut.

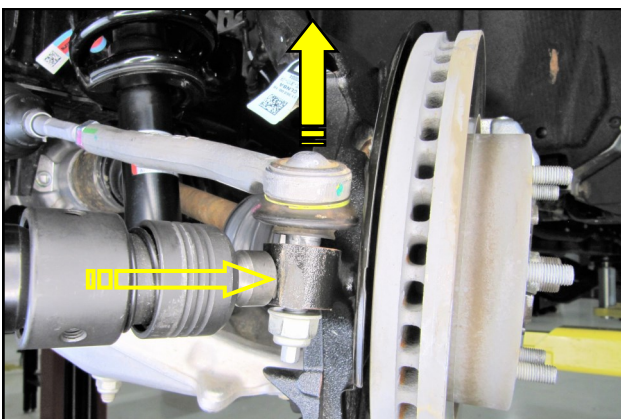

**5.** Using an air hammer or equivalent, strike the knuckle as shown to loosen the tie rod end. Remove the nut and separate the tie rod from the knuckle.

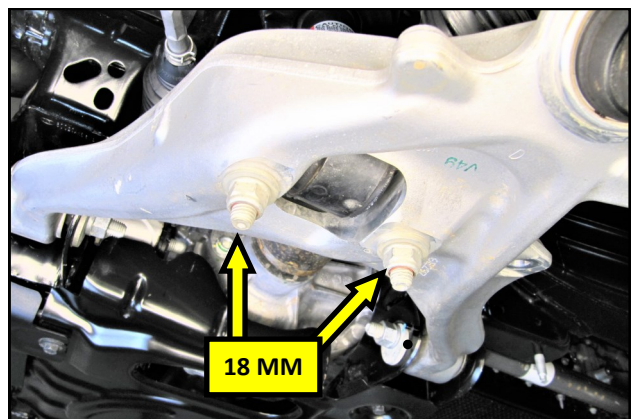

**6.** Using a 18 mm socket, remove the lower shock nuts in the control arm and set them aside.



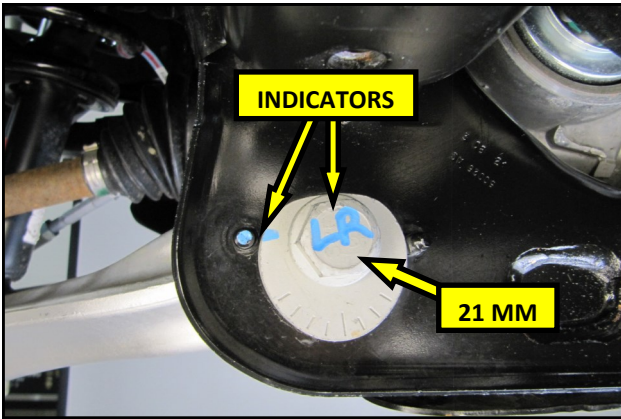

7. Using a high contrast paint pen, mark the alignment cams of the lower control arm bolts and the frame with position and adjustment indicators. Using a set of 21 and 24 mm wrenches, Remove the front and rear, lower control arm bolts, cams, and nuts.

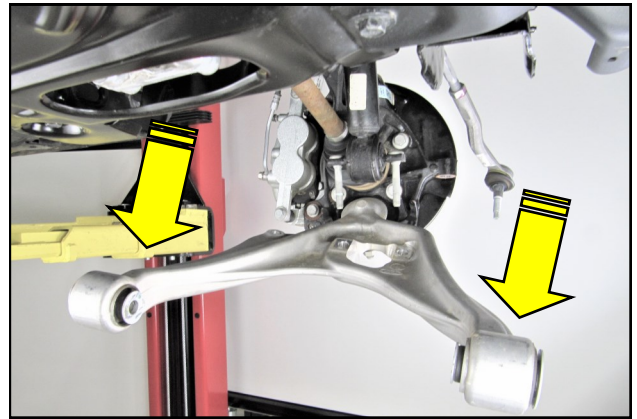

8. Pry the control arm out of the frame as shown while carefully guiding the shock studs to avoid thread damage.

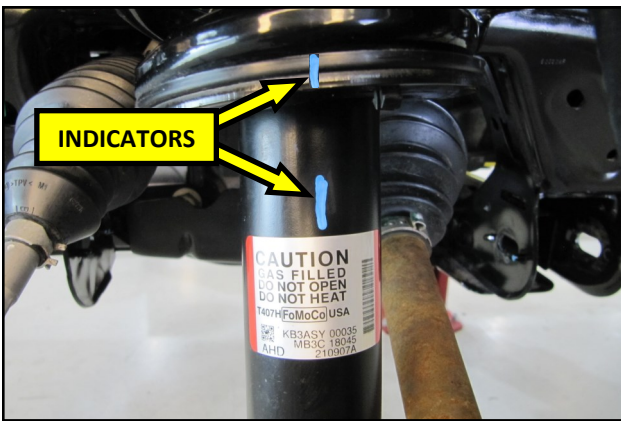

9. Using a high contrast paint pen, mark the shock body and spring perch with position indicators facing the knuckle. This will aid in correctly reassembling the suspension.

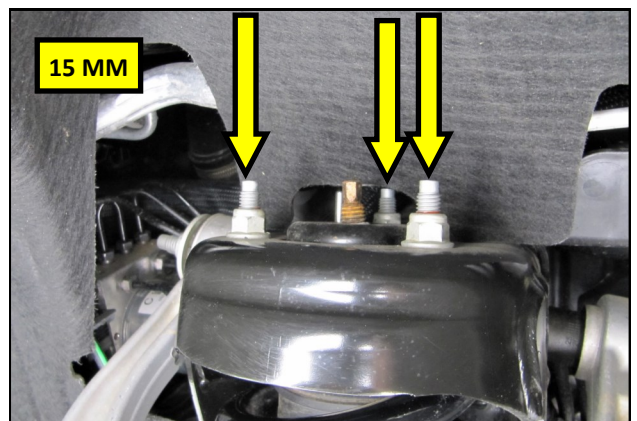

10. Using a 15 mm socket, remove the 3 upper shock nuts and carefully remove the shock assembly from the vehicle.

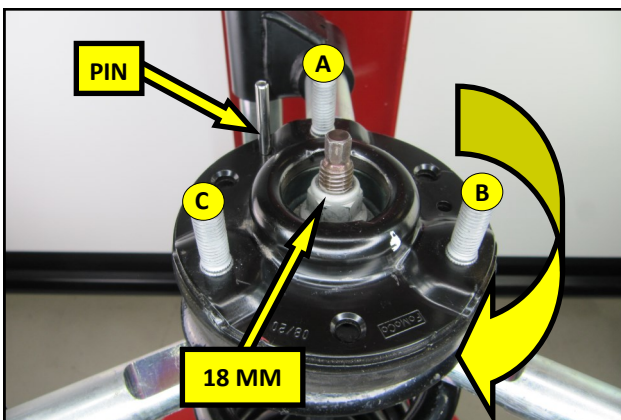

11. Place the shock assembly into a spring compressor as shown. Compress the spring and remove the upper mount. Rotate the upper mount 180 degrees and reinstall it. **IMPORTANT– Do not rotate any other components in the assembly.**

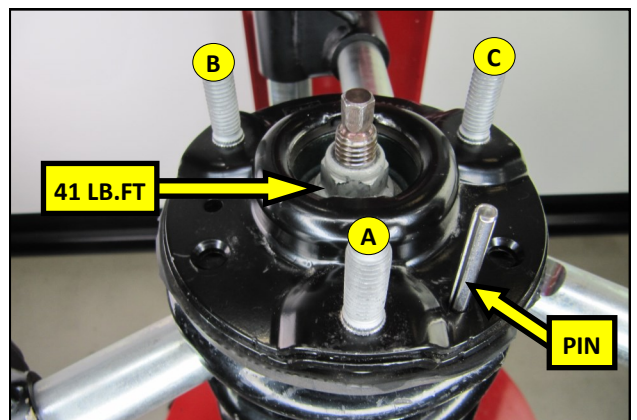

12. When properly reassembled, stud A and the alignment pin will be in the locations in the photo above. Torque the shock rod nut to 41 Lb. ft.

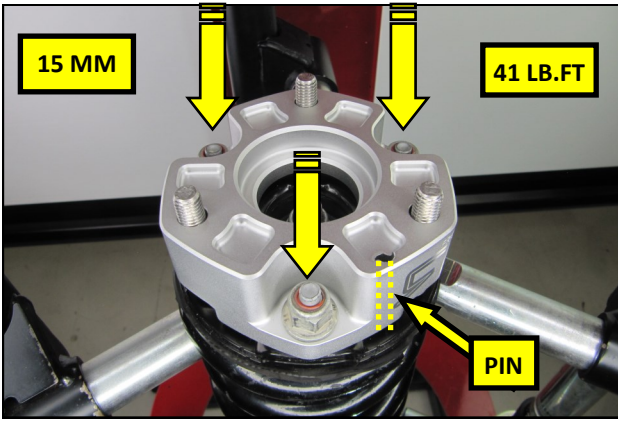

**13.** Install an RTR Spacer marked Front onto the top mount as shown. Secure the Spacer using the OEM hardware removed in step 10. Torque the nuts to 41 Lb. ft.

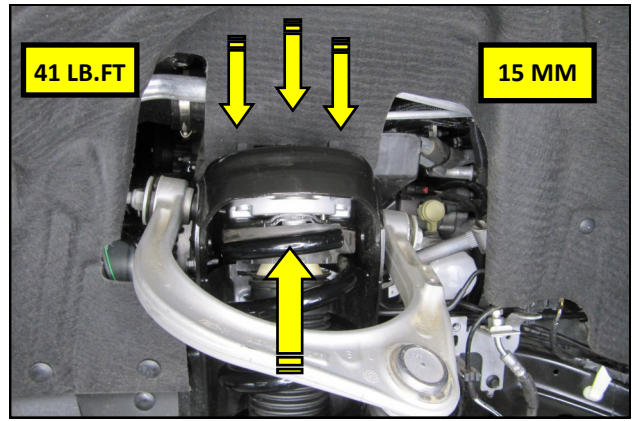

**14.** Verify proper positioning of the shock indicators from step 9 and raise the shock and Spacer assembly up and into the vehicle as shown. Secure the assembly using the supplied M10 Lock Nuts. Torque the nuts to 41 Lb.ft.

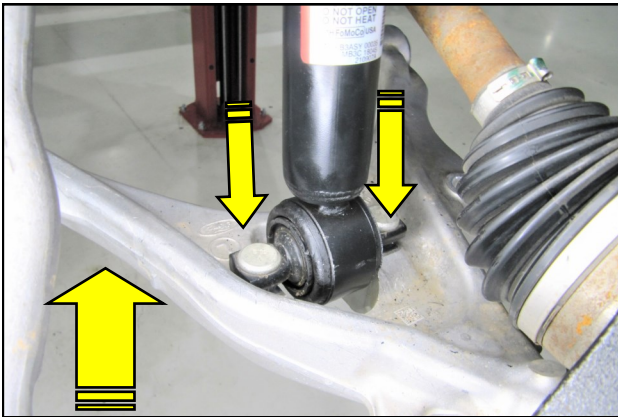

**15.** Carefully raise the control arm by hand, and guide the shock studs into the lower control arm as shown.

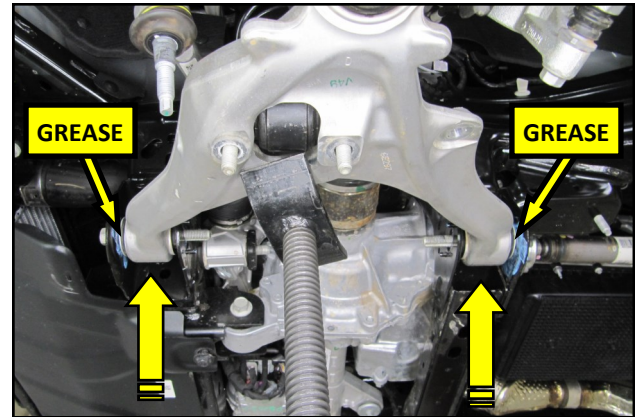

**16.** Use a suitable jack to raise the control arm into the frame. Reinstall the bolts, cams and nuts removed in step 7, into their respective locations. **HINT**– A light coat of synthetic grease applied to the frame will ease reassembly.

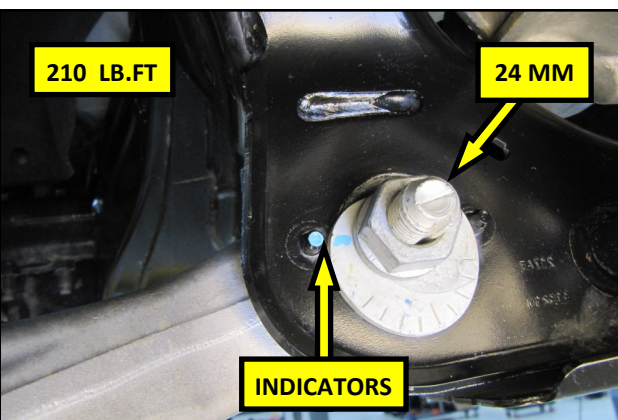

**17.** Adjust the control arm back into proper position using the indicators marked in step 7. Torque the bolts to 210 Lb.ft.

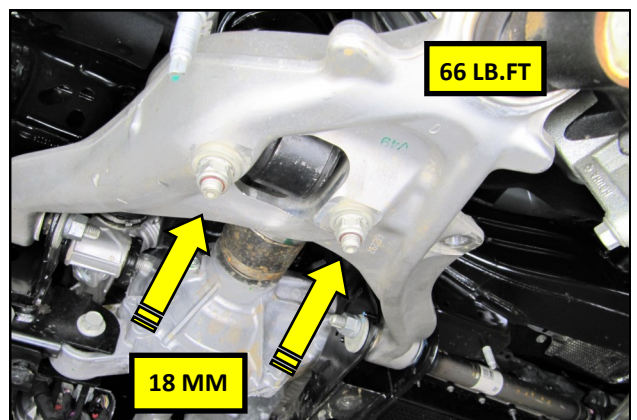

**18.** Secure the shock to the control arm using an 18 mm socket and the hardware removed in step 6. Torque the Nuts to 66 Lb. ft. Repeat steps 4–18 on the opposite side of the vehicle.



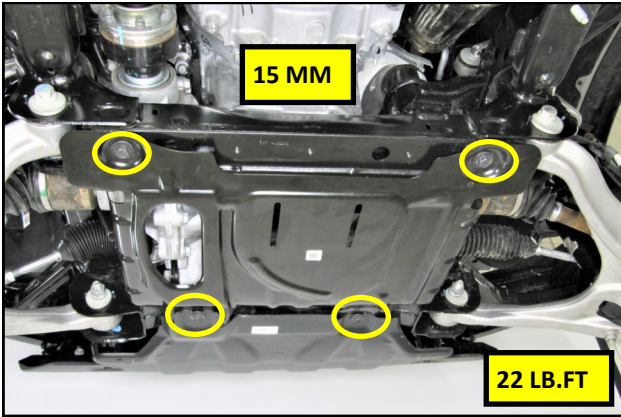

19. Reinstall the skid plate removed in step 3. Torque the bolts to 22 lb.ft

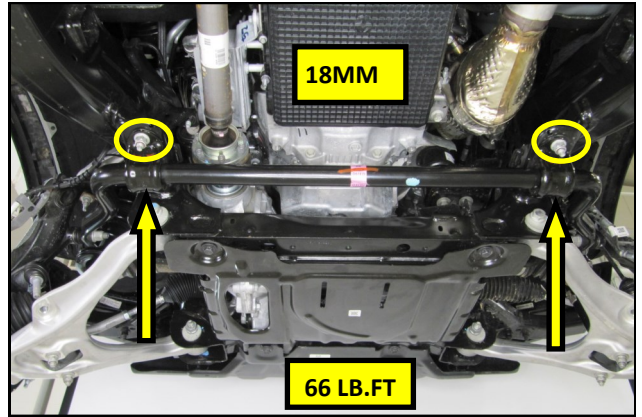

20. Reinstall the sway bar onto the frame using the hardware removed in step 2. Torque the Bolts and nuts to 66 lb.ft.

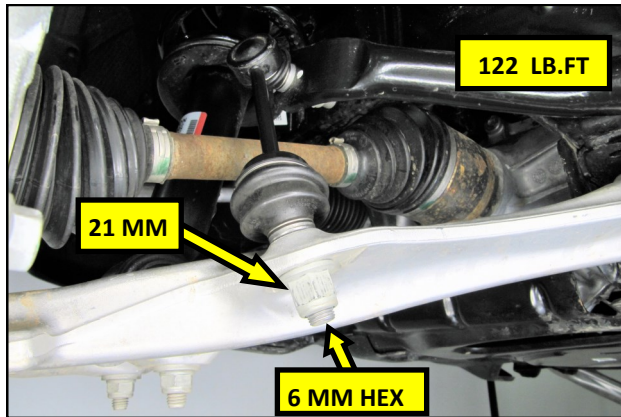

21. Reconnect the sway bar links to both the Left and right side control arms using the nuts removed in step 1. Use 21 mm wrench and a 6 mm hex socket to tighten both the nuts and Torque the nuts to 122 Lb.ft.

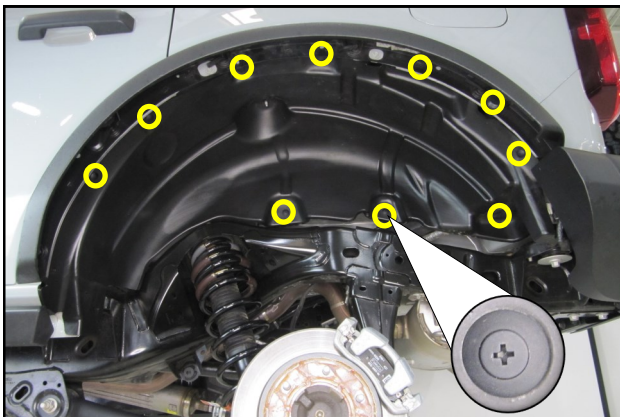

22. **REAR SPACERS.** Using a number 2 Phillips head screwdriver and panel clip removal tool, remove the plastic rivets in the fender liner.

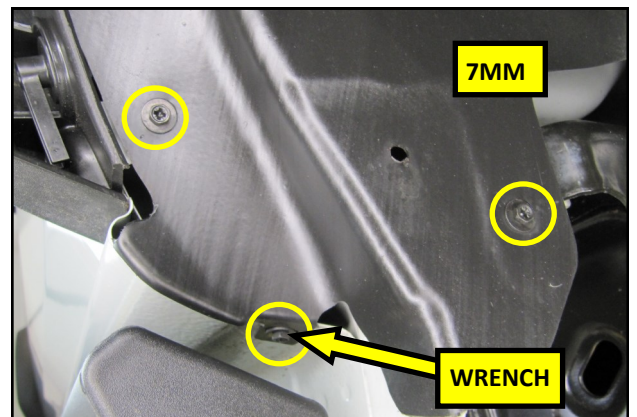

23. Using a 7mm socket and wrench, remove the 3 screws at the front of the fender liner.

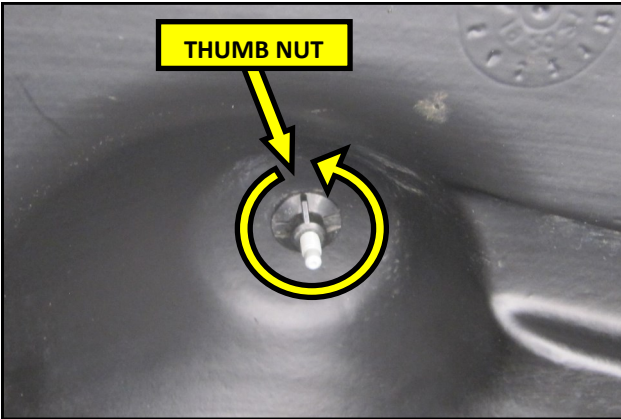

**24.** Remove the plastic thumb nut, or nuts, at the top of the fender liner.

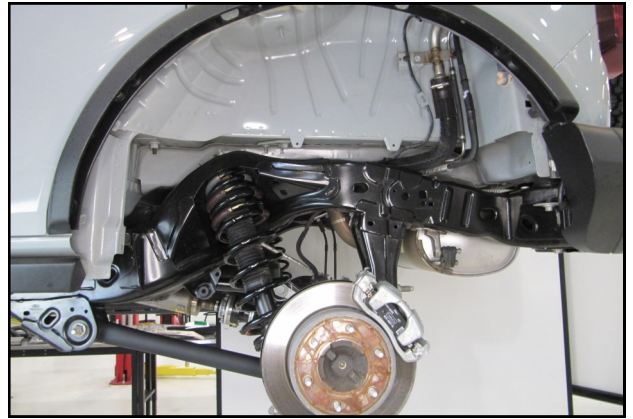

**25.** Remove the liner from the vehicle to gain full access to the suspension.

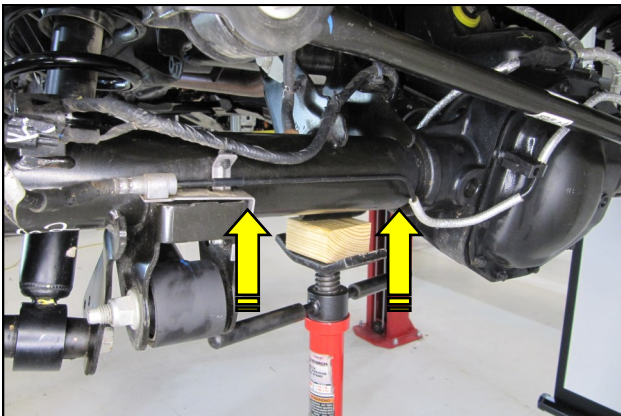

**26.** Using a suitable jack, support the axle tube as shown.

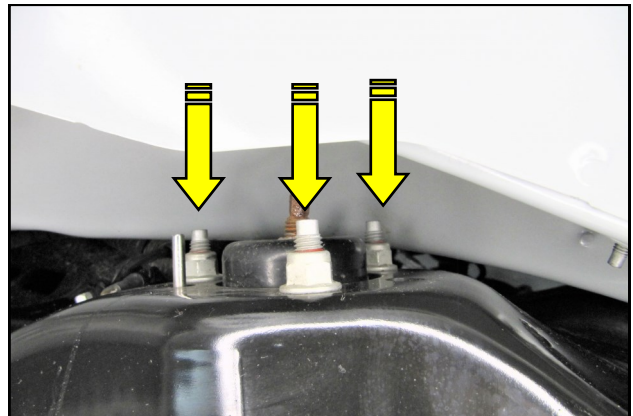

**27.** Using a 15 mm socket, remove the 3 upper shock nuts and set them aside.

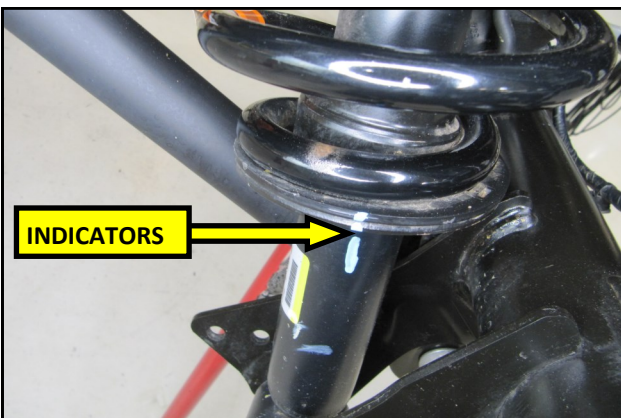

**28.** Using a high contrast paint pen, mark the shock body and spring perch with a position indicator facing the Hub. This will aid in reassembly.

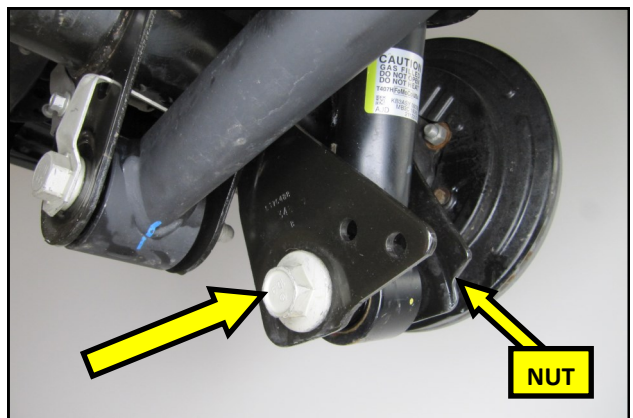

**29.** Using a 27 MM socket, remove the lower shock bolt and nut.



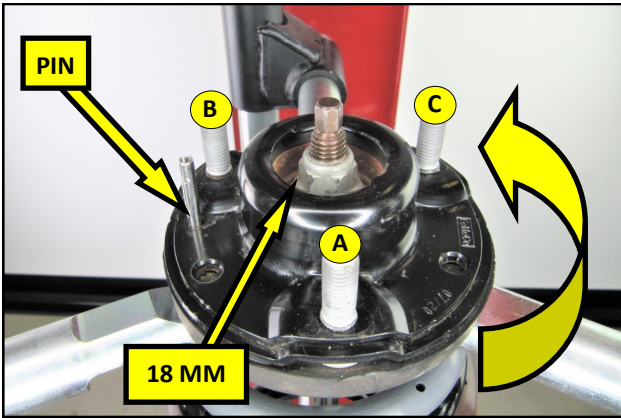

**30.** Place the shock assembly into a spring compressor as shown. Compress the spring and remove the upper mount. Rotate the upper mount 180 degrees and reinstall it. **IMPORTANT**– Do not rotate any other components in the assembly.

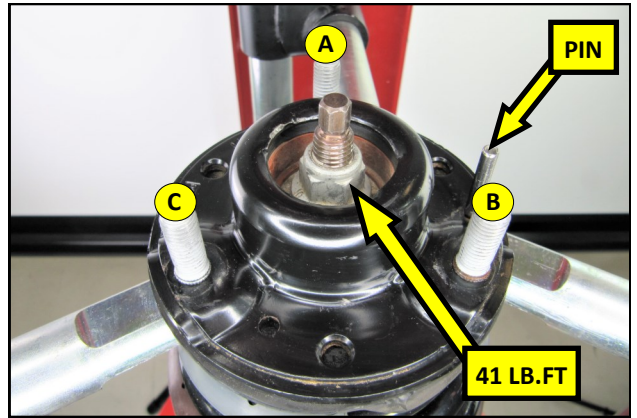

**31.** When properly reassembled, stud **A** and the alignment pin will be in the locations in the photo above. Torque the shock rod nut to 41 Lb. ft.

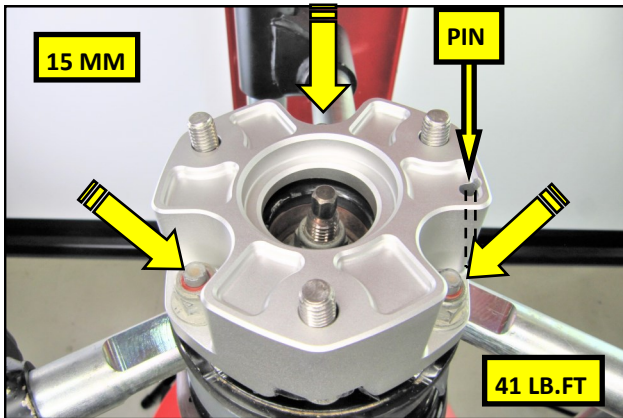

**32.** Install an RTR Spacer marked Rear onto the top mount as shown. Secure the Spacer using the OEM hardware removed in step 27. Torque the nuts to 41 Lb.ft.

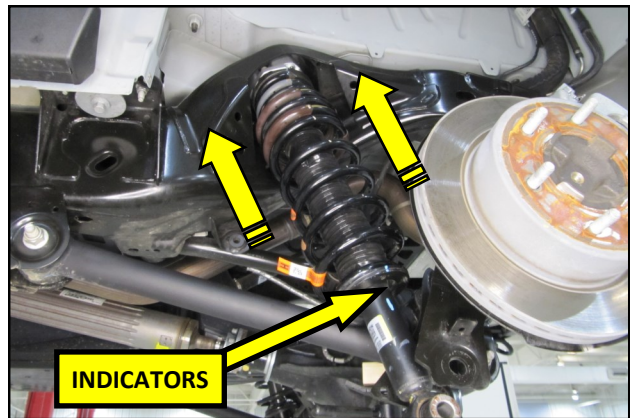

**33.** Verify proper positioning of the shock indicators from step 28 and raise the shock and Spacer assembly up and into the vehicle as shown.

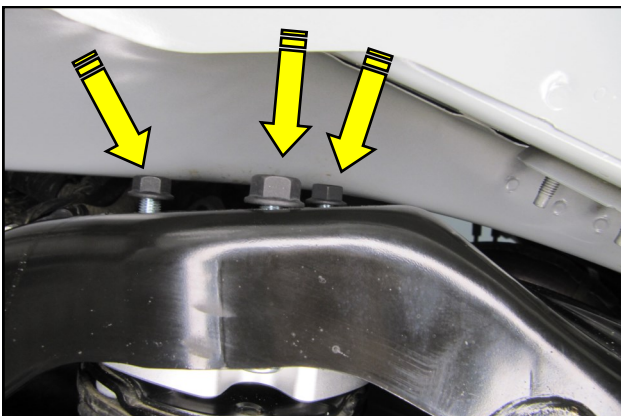

**34.** Hand thread 3 of the supplied M10 Lock Nuts onto the Spacer studs to suspend the shock assembly in the vehicle.

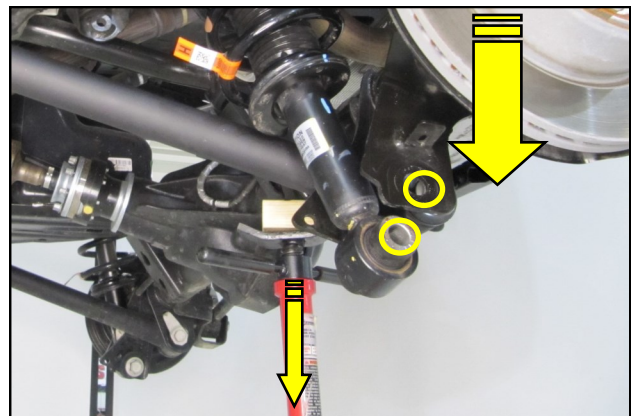

**35.** Lower the jack to align the shock mount with the shock.

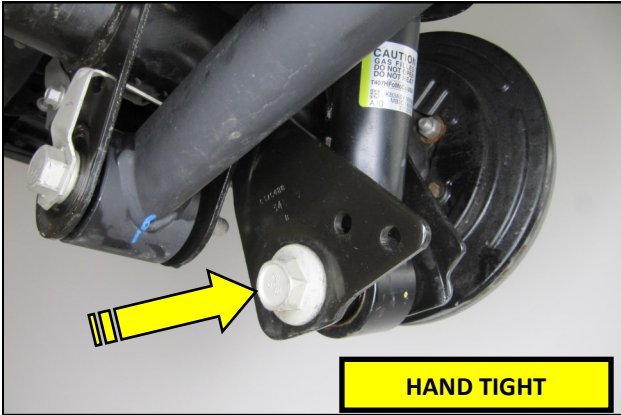

**36.** Secure the shock into the shock mount using the nut and bolt removed in step 29. Tighten the bolt, hand tight.

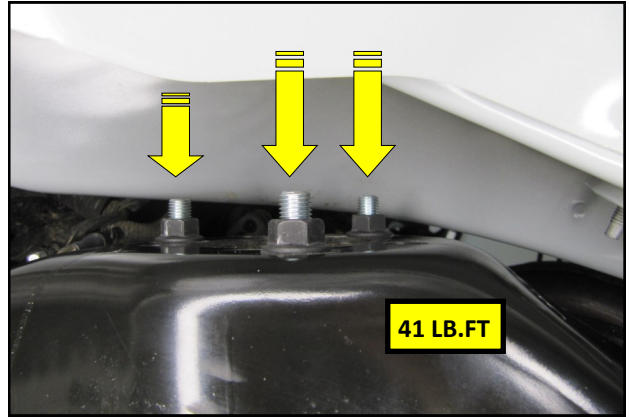

**37.** Torque the upper shock nuts to 41 Lb.ft.

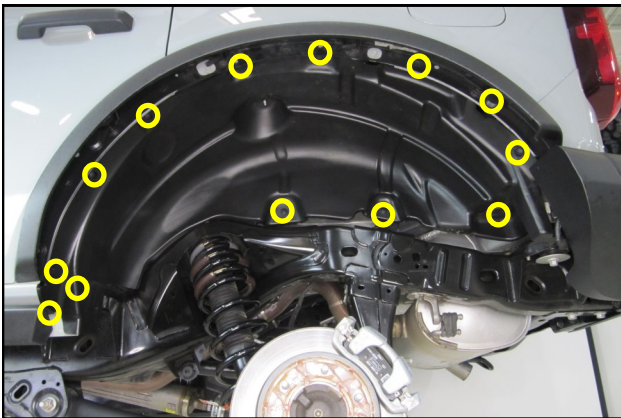

**38.** Reinstall the fender liner using the hardware removed in step 22. Repeat steps 22 –38 on the opposite side of the vehicle.

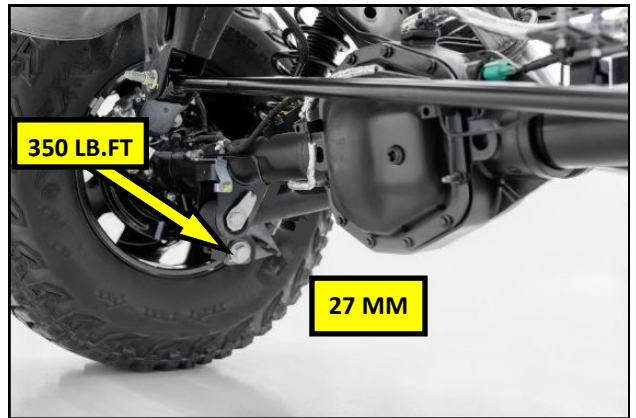

**39.** Reinstall the wheels and tires and lower the vehicle onto the ground. Torque the lower shock bolts to 350 Lb.ft. Perform a comprehensive test drive and align the vehicle to the manufacturers specifications.