

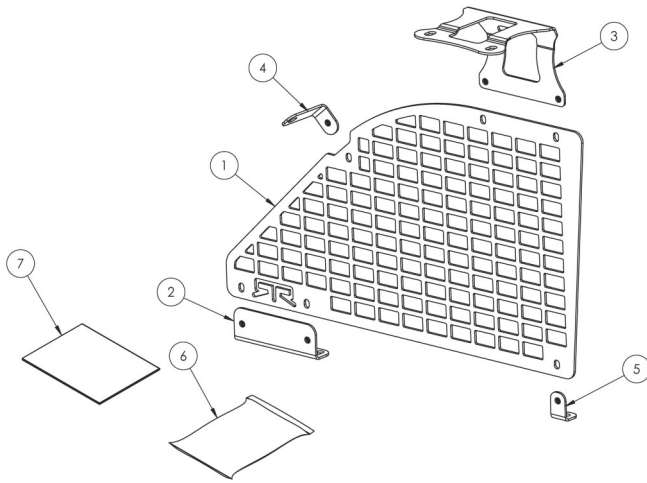

**2021-22 Ford Bronco**  
**RTR MOLLE Plate**  
**Part Number 14031.005.15.A**



**Components Included**

1.	MOLLE Plate	1
2.	Large Bottom Bracket	1
3.	Top Bracket	1
4.	Mid Bracket	1
5.	Small Bottom Bracket	1
6.	Hardware Pack	1
7.	Instructions	1

This RTR product is only intended to be installed on 4 Door Hard top equipped vehicles. Installation of this product requires removal of the top and the help of an assistant. The RTR MOLLE Plate is designed to be installed inside the Driver or Passenger side quarter windows.

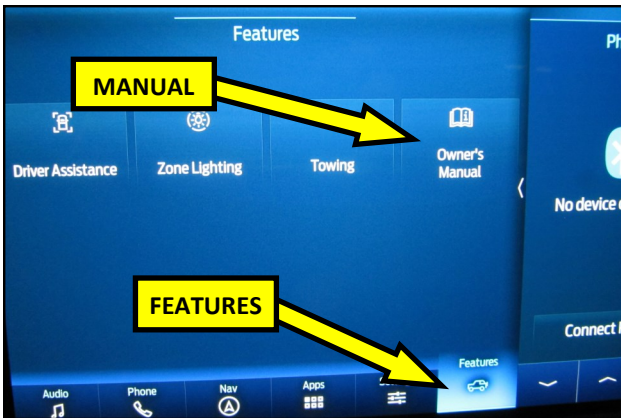

1. Push the start button once to put the vehicle into Accessory mode and select **Features**, then **Owner's Manual** in the center display.



2. Select the appropriate removal instructions, **2** or **4** door.

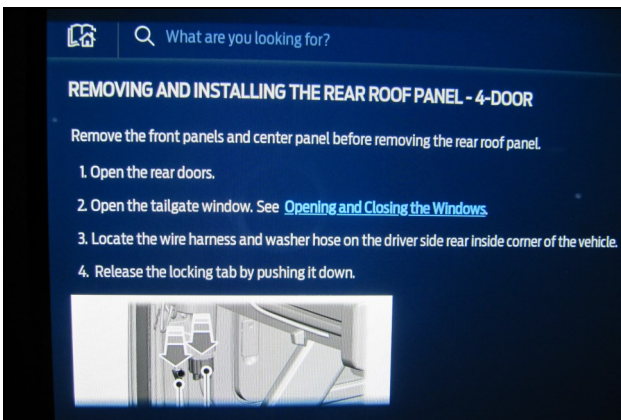

3. Using the procedure selected, remove the vehicle top and set it aside.

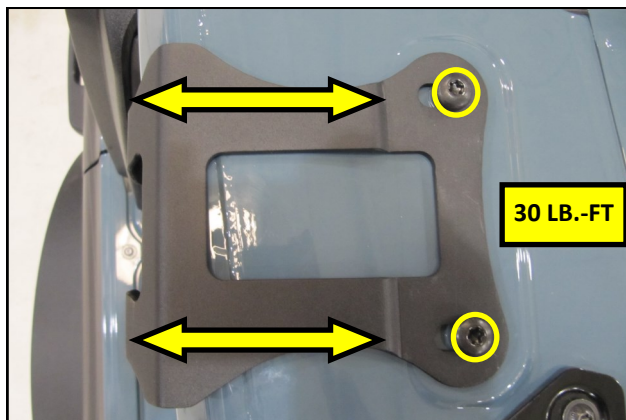

4. Using two of the supplied M8 Bolts, mount the Top Bracket to the roof as shown, with sufficient clearance between the bracket and vehicle. Using a T-40 TORX® driver, torque the Bolts to 30 Lb.-Ft. Return the top onto the vehicle but do not secure it with the hardware.

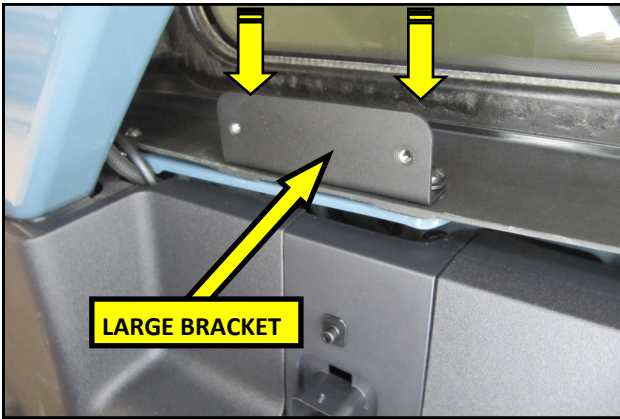

6. With the top on the vehicle, install the Large Bottom Bracket as shown using the OEM hardware. Torque the bolts to 106 in.- lbs.

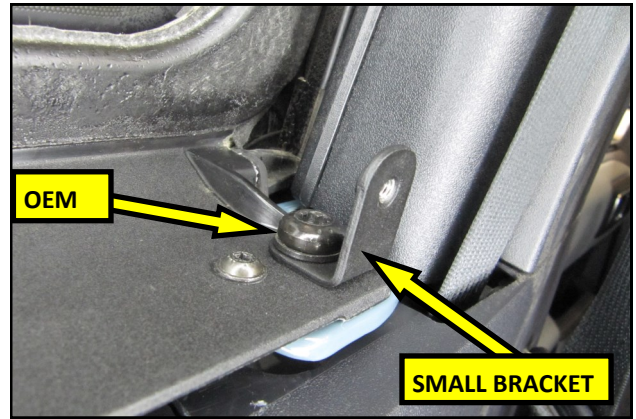

5. Install the Small Bottom Bracket as shown, using the OEM hardware. Torque the bolts to 106 in.- lbs.

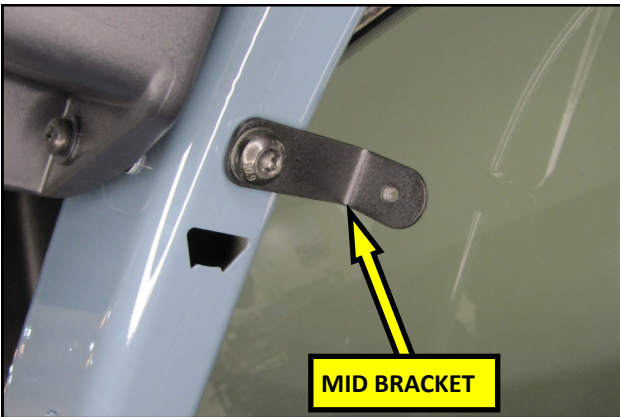

7. Using the third supplied M8 Bolt, mount the Mid Bracket to the vehicle as shown. Leave the Bolt loose to allow for final adjustment.

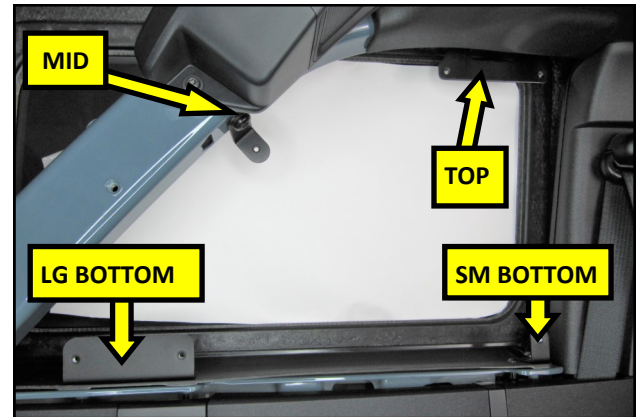

8. Locations of all 4 brackets when properly installed in the vehicle.

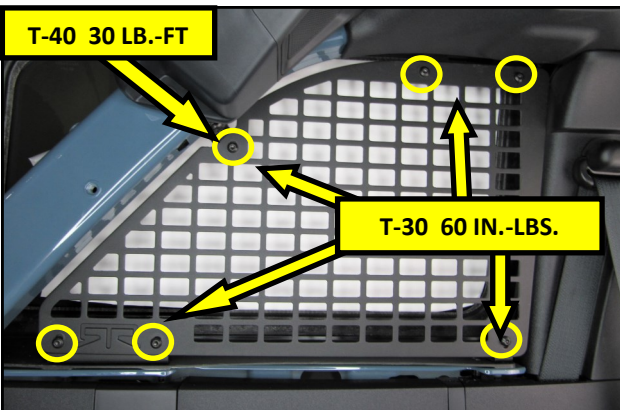

9. Using a T-30 TORX® driver and the supplied M6 Bolts, secure the RTR MOLLE Plate to the Brackets. Torque the fasteners to 60 in.-Lbs. Adjust the Mid Bracket if needed, and Torque the Bracket Bolt to 30 Lb.-Ft. Reinstall the remaining OEM hard top hardware.

Using the RTR MOLLE Plate, you can attach these and other items to your vehicle:

- First aid kits
- Magazine pouches
- Canteen carriers
- Sustainment pouches
- D-rings for slings and other gear
- Flashlight Holder
- Holster
- General-purpose gear pouches in various sizes