

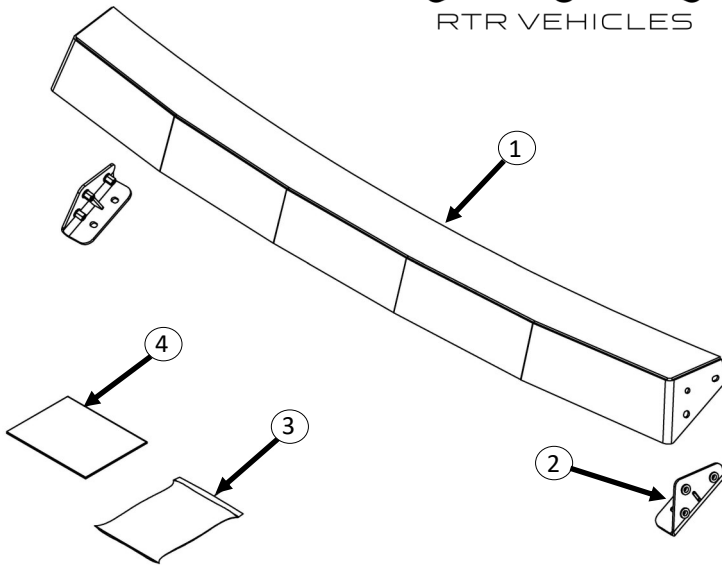

**2021 Ford Bronco  
Universal Light Bar Base  
Part number 14021.0003.14.C**

**Components Included**

1.	Light Bar Base	1
2.	Light Bar Bracket	2
3.	Hardware Pack	1
4.	Instructions	1



**NOTE:** In addition to common hand tools, installation of the RTR Light Bar will require the use of a 6" torpedo level.

The RTR Universal Light Bar Base is intended to be a means by which overhead lighting can be installed onto the Bronco. Light type, wiring and switching is left to the discretion of the installer.

This RTR product is not intended to be installed on vehicles equipped with the OEM Roof Rails with Crossbars.

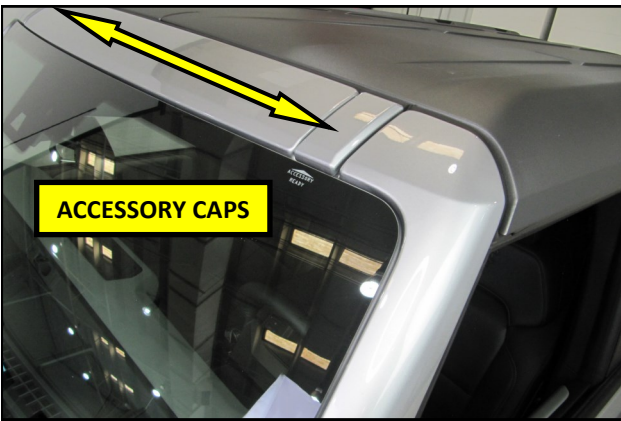

**1.** Using a plastic trim removal tool, pry off both of the accessory caps and set them aside.

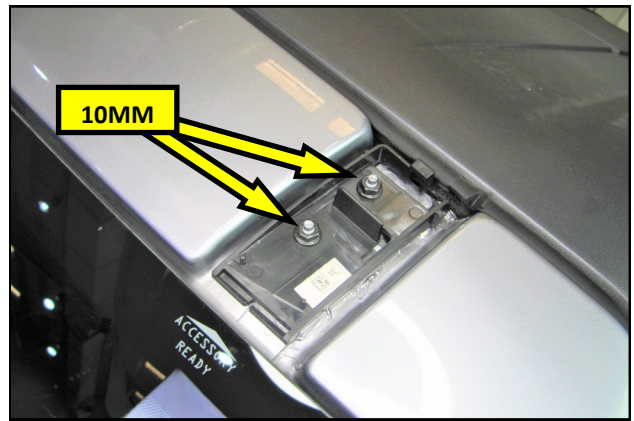

**2.** Using a 10 mm socket, remove the flange nuts securing the cap retainers to the vehicle. Retain the nuts for reuse.

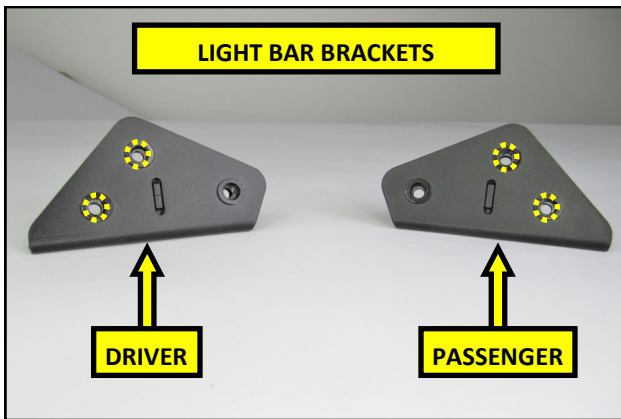

**3.** Locate and identify the Driver and Passenger side Light Bar Brackets.

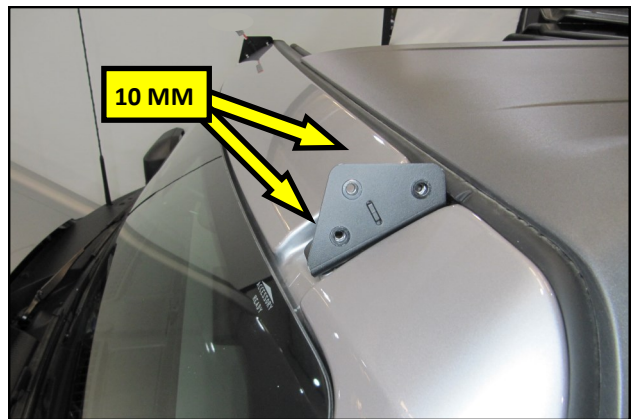

**4.** Install the Light Bar Brackets onto the vehicle as shown, using the OEM nuts removed in step 2. Leave the nuts snug at this time.

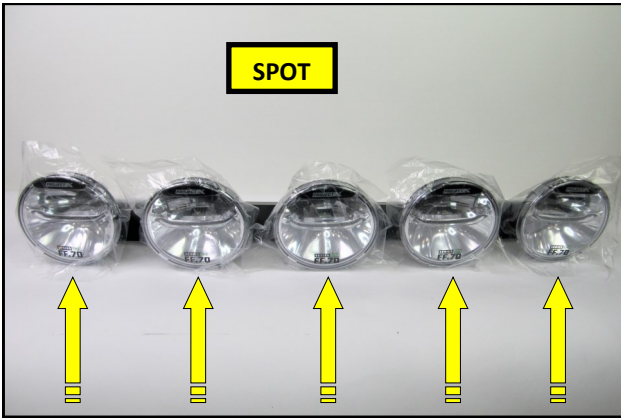

5. Mount the lighting to the RTR Base. Lighting can be mounted to the face of the Base or on top of the Base. **NOTE:** Verify that the intended light mounting method will not interfere with the vehicle once installed.

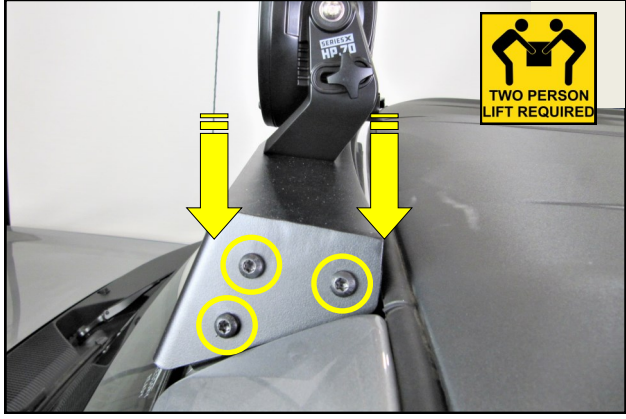

6. With the help of an assistant, lower the Light Bar assembly onto the Light Bar Brackets. Secure the Bar on each side using the 6mm Button Head Bolts and Washers. Leave the bolts snug for now.

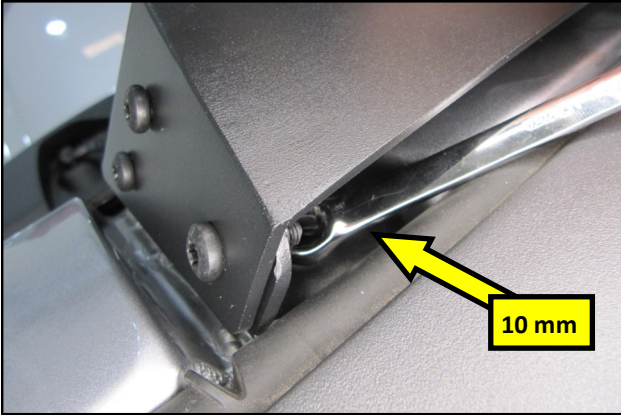

7. Using a 10mm wrench, tighten the 4 Bracket nuts from steps 29 and 30.

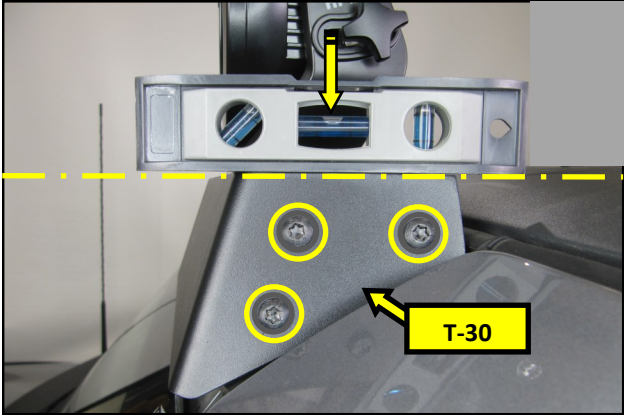

8. With the vehicle parked on level ground, place a level on the top of the Light Bar as shown. Adjust the angle of the Light Bar as needed to get it parallel to the ground. Tighten all six light Bar screws, final tight.



9. The light bar is now ready to be wired, switched and aimed.

◆ Warranty information can be found at [www.RTRVehicles.com](http://www.RTRVehicles.com)