

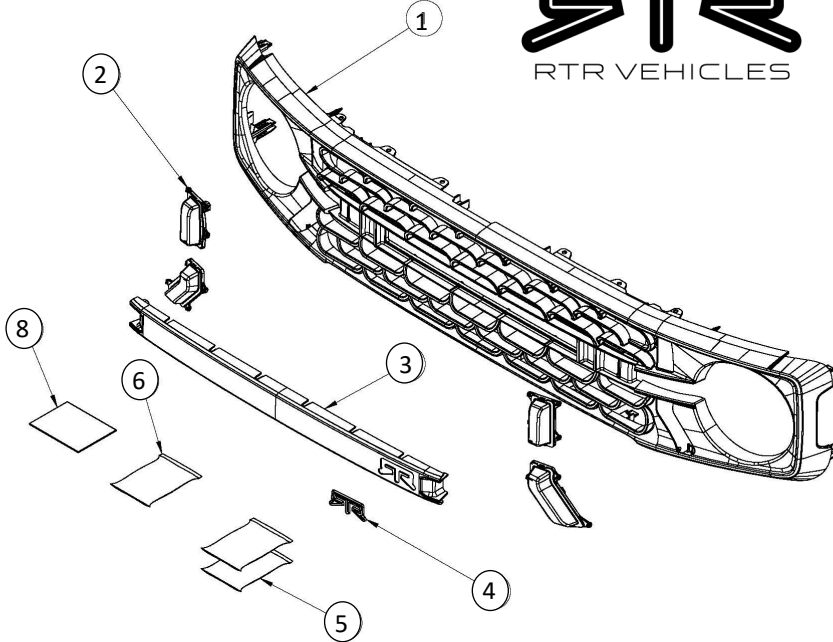

2021 Ford Bronco
RTR Grille
Part number 14011.0001.15.A

Component Identification

1.	Grille	1
2.	Grille Lights	1
3.	Center Bar	1
4.	RTR Badge	1
5.	Wire Harness	2
6.	Hardware Pack	1
7.	Air Deflector (not shown)	1
8.	Instructions	2



1. Safely support the vehicle on a hoist or jack stands and remove the front wheels and tires.

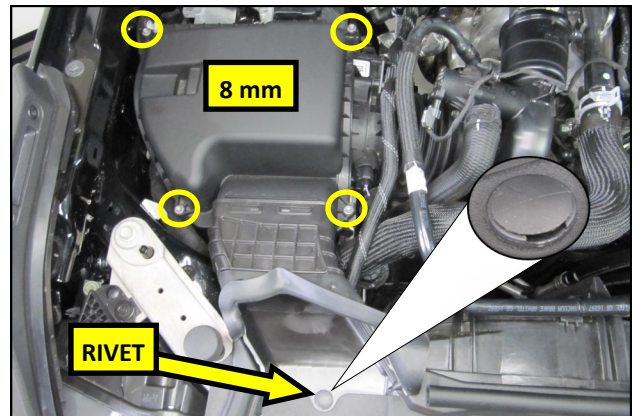

2. Using a panel clip removal tool or equivalent, pry open the plastic rivet in the air box inlet and remove it. Using an 8mm socket, remove the 4 air box screws and remove the air box lid from the vehicle.



3. Remove the 8 plastic rivets in the core support cover and remove the cover from the vehicle.

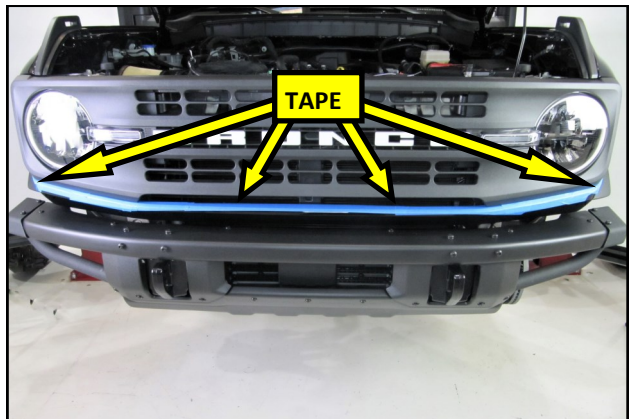

4. Prepare the vehicle for grille removal by applying a protective layer of painters tape on the bumper fascia, as shown.

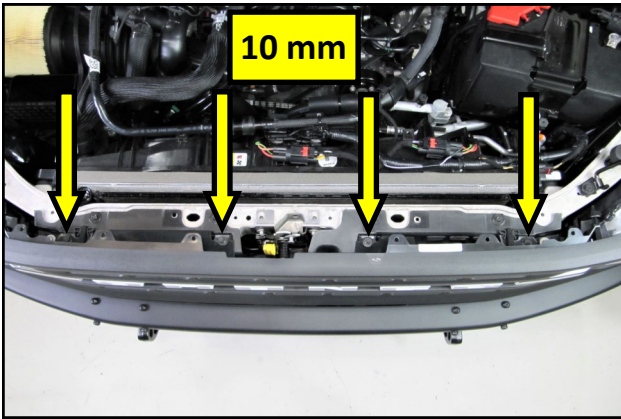

5. Using a 10 mm socket, remove the four bolts securing the grille to the core support. Retain these bolts, they will be reused with the RTR Grille.

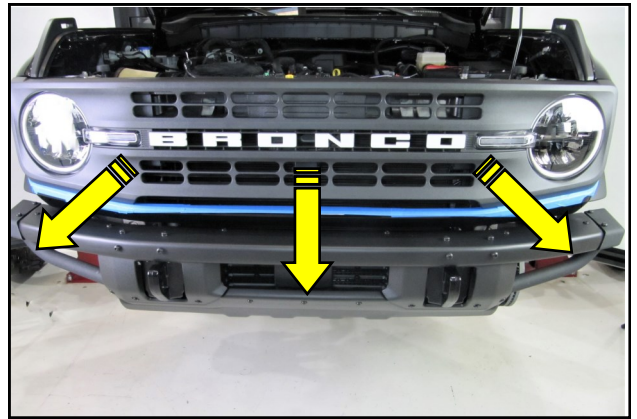

6. Carefully pull the grille forward, away from, and out of the vehicle. Set the grille, face down, on a workbench.

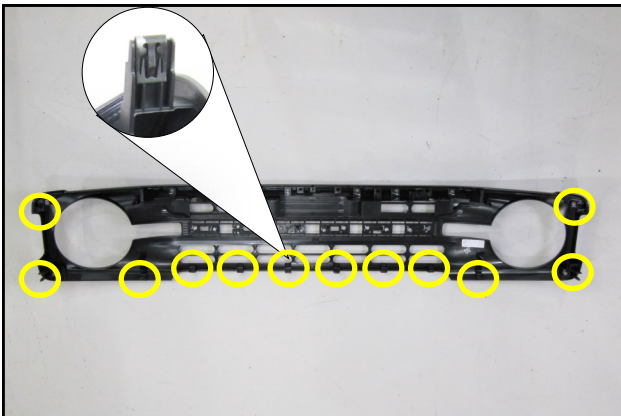

7. Using a pocket screwdriver or equivalent, carefully remove the 12 trim clips from the back of the OEM grille.



8. Transfer 12 OEM trim clips onto RTR Grille tabs as shown.

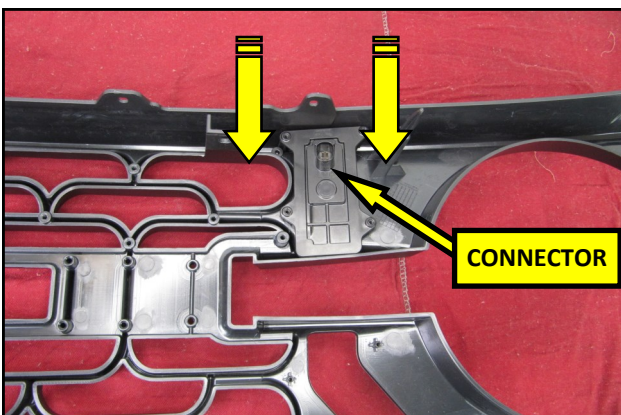

9. Place the Upper Grille Lights into their respective locations on the RTR Grille. The RTR Lights are side specific and are marked accordingly at the connector.

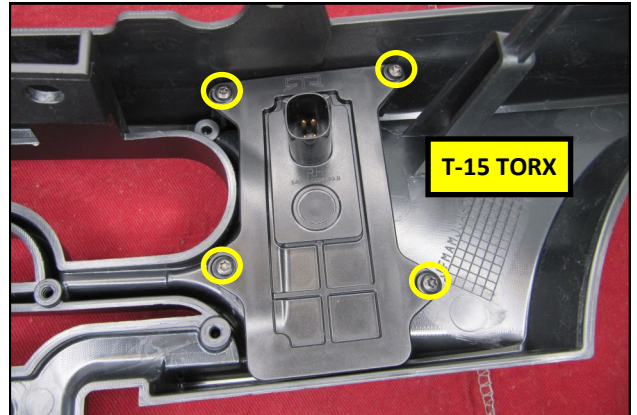

10. Using a T-15 TORX® driver, secure the Upper Grill Lights to the Grille using the supplied #6 Screws. **Do Not Over Tighten.**

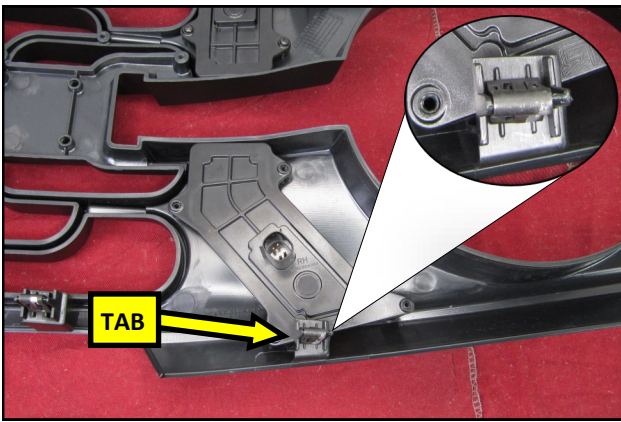

11. Place the Lower Grille Lights into their respective locations on the RTR Grille. **NOTE:** when properly installed, the bottom of the lights will be under the trim clip tab.

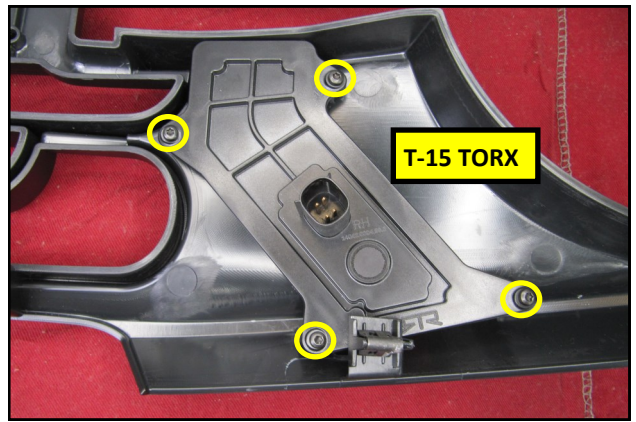

12. Using a T-15 TORX® bit, secure the Upper Grill Lights to the Grille using the supplied #6 Screws. **Do Not Over Tighten.**

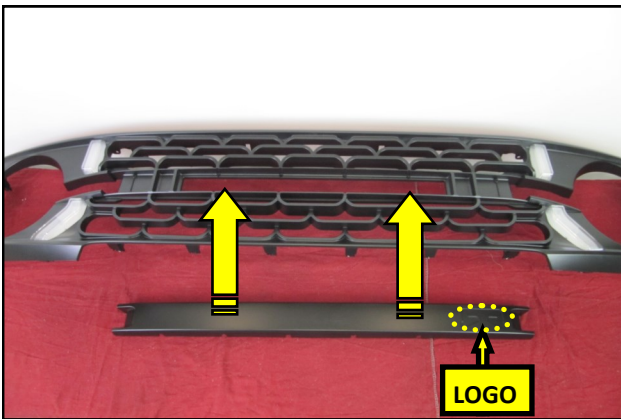

13. Place the Center Bar onto the face of the RTR Grille and align it with the features of the Grille. Gently press it into the Grille until it is fully seated. When properly installed, the RTR logo will be on the Driver side of the Grille.

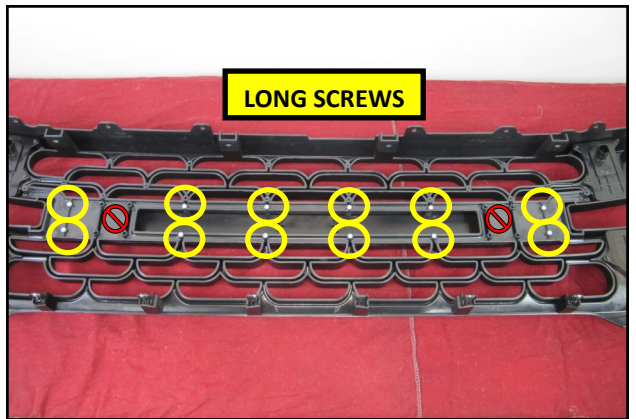

14. Using a T-20 TORX® driver, secure the Center Bar to the Grille using the 1" (Long), #8 Screws. **Do Not Over Tighten.**
NOTE: 8 of the center Grille holes will not be used.

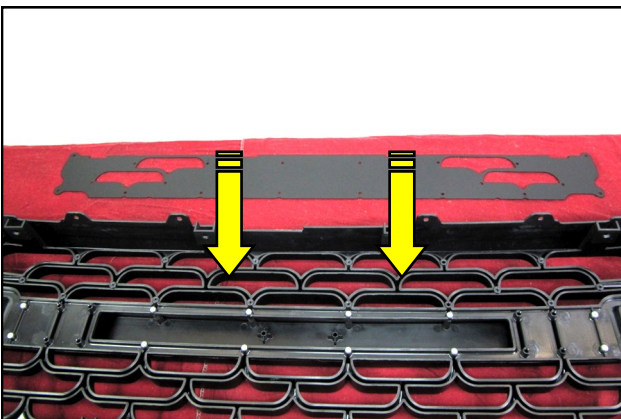

15. Place the Air Deflector, texture side down, onto upper portion of the RTR Grille.

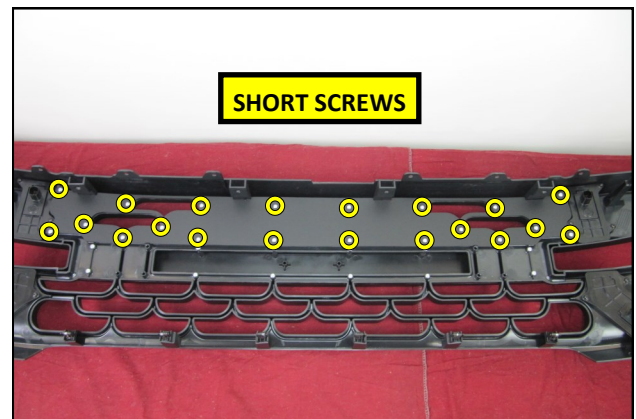

16. Align the Deflector with the Grille as shown. Using a T-20 TORX® driver, secure it using the supplied 1/2", (Short), #8 Screws. **Do Not Over Tighten.**

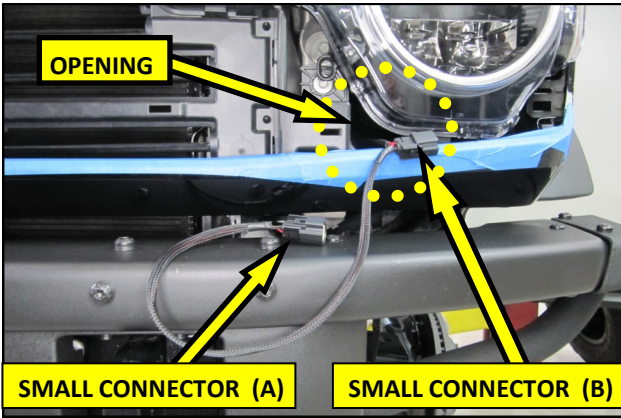

17. Feed the RTR Lighting Harnesses, Large Connectors first, into the vehicle through the openings between the grille shutter and the headlamps. Stop at the Small Connector, (B).

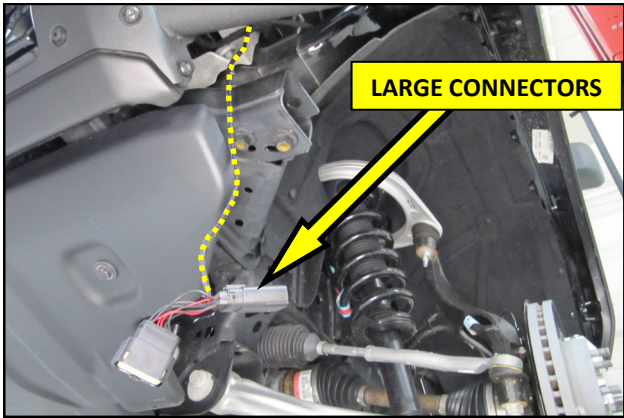

18. Feed the RTR Lighting Harnesses, Left and Right, down and out of the front of the vehicle as shown.

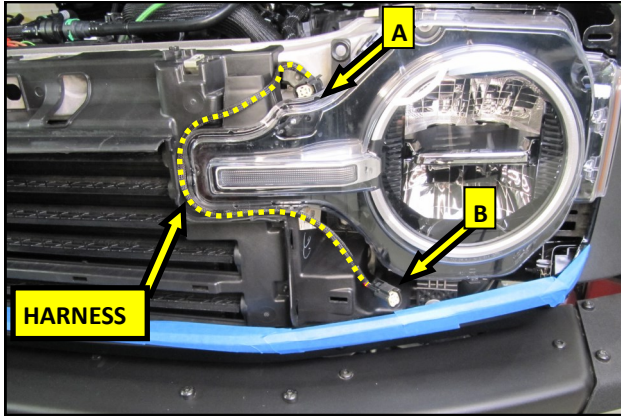

19. Route the Small Connector side of the Harnesses up and around both of the head lamps, as illustrated.

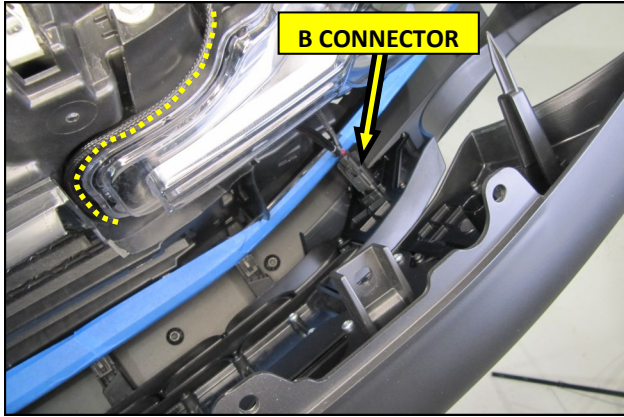

20. With the help of an assistant, raise the RTR Grille up towards the vehicle and connect the B Connectors to the Lower Grille Lights.

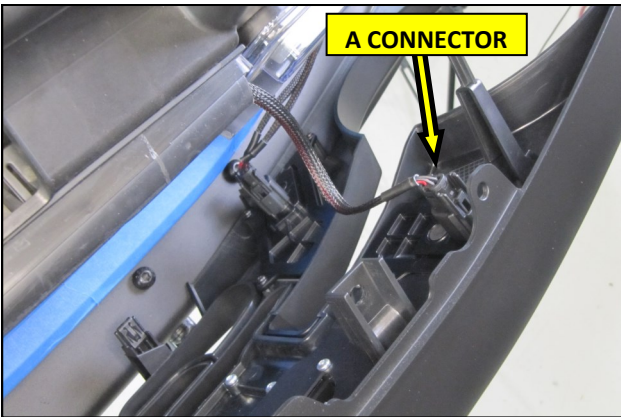

21. Connect the A Connectors to the Upper Grille Lights.

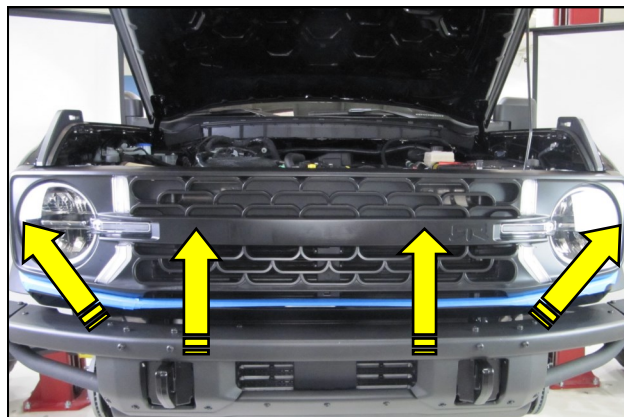

22. With the help of an assistant, carefully slide the Grille and Light assembly into the vehicle as shown. Check for any exposed harness, and tuck as needed. Press firmly at all tab locations to lock the grille in.

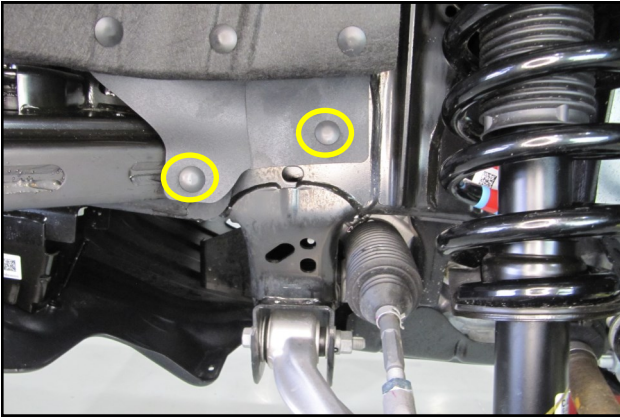

23. Using a panel clip removal tool or equivalent, pry the 2 fender liner fir tree anchors out of the frame.
NOTE: The anchors do not to be removed from the liners.

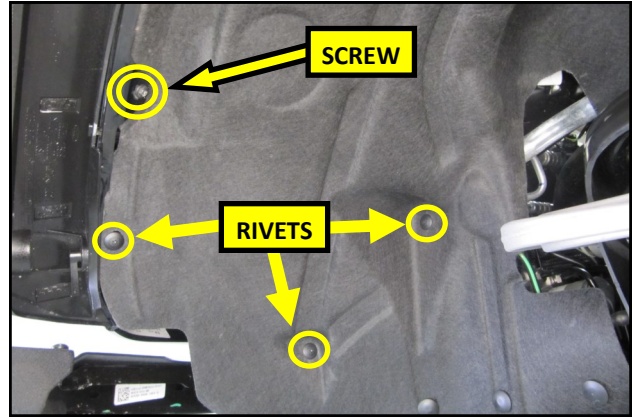

24. Using a #2 Phillips head screwdriver, remove the first screw in the front of the fender liners and 3 plastic rivets.

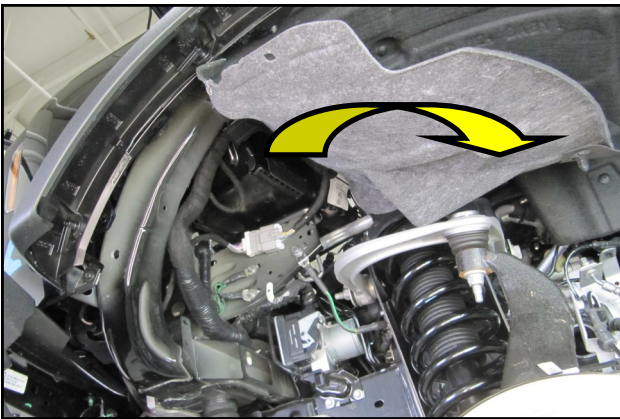

25. Pull the fender liners back and onto the control arms as shown.

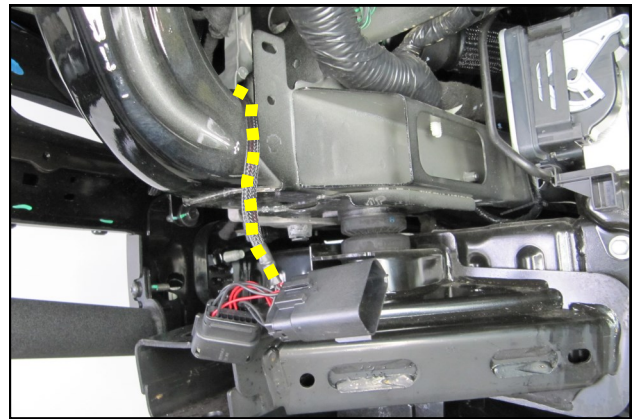

26. Route the RTR Large Connector Harnesses, Left and Right, up and over the chassis and into the inner fender area.

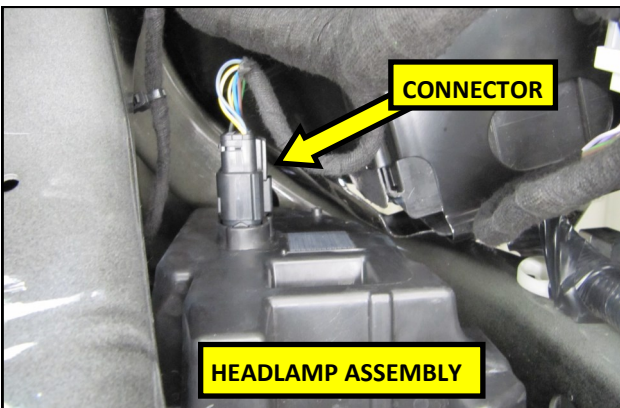

27. Locate and disconnect the head lamp connectors in the back of the Left and Right head lamp assemblies.

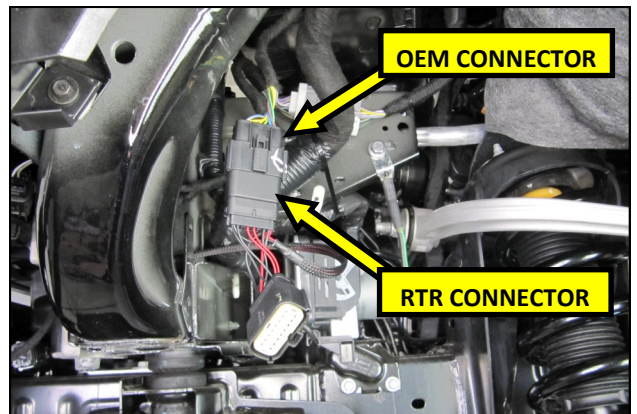

28. Connect the OEM headlamp connectors to corresponding Connectors in the RTR Harnesses.

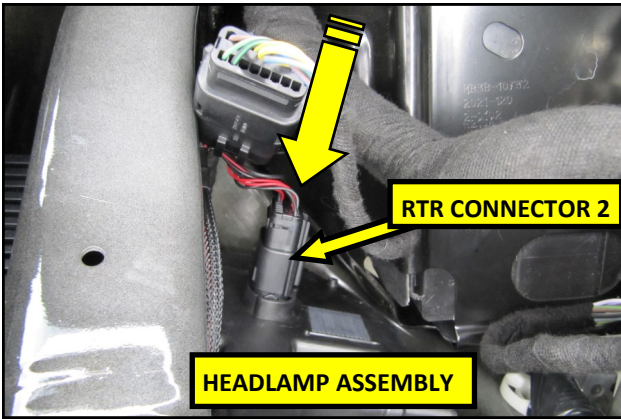

29. Connect the two remaining RTR Connectors to the headlamp assemblies.



30. Turn the headlights on and perform a function check. Verify that all 4 RTR Lights and the OEM lights illuminate when energized. Remove the painters tape following a successful test.

Mode descriptions and troubleshooting tips and can be found on page 7.

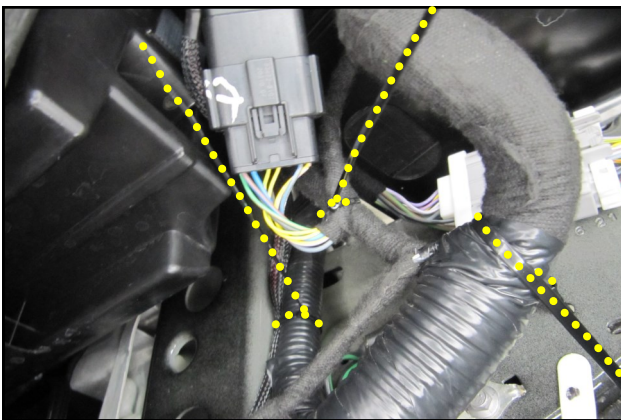

31. Secure the RTR Wiring to the OEM wiring as shown, using 3 of the supplied Cable Ties per side. Trim the Cable Tie excess when fully secure.

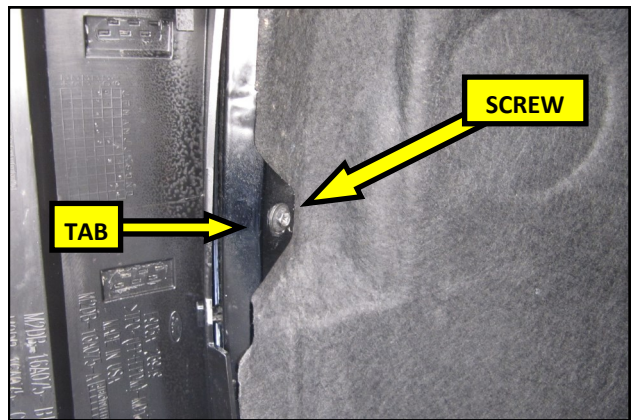

32. Unfold the fender liners and return them into position. Tuck the liners behind the fender tabs and reinstall the screws removed in step 24.

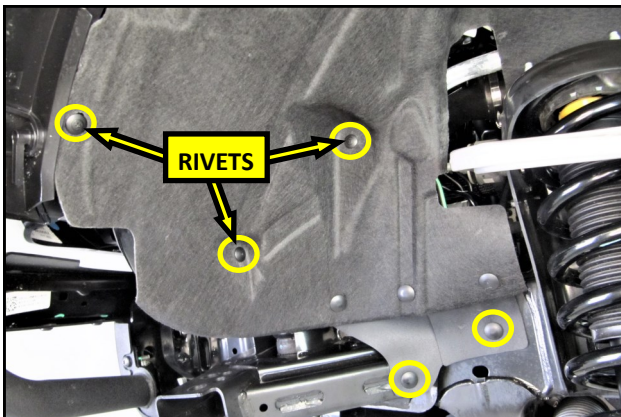

31. Reinstall the plastic rivets and fir tree anchors removed in steps 23. and 24.

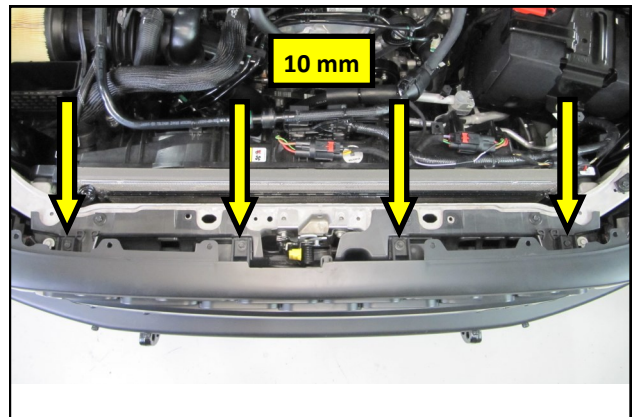

32. Using a 10 mm socket, reuse the 4 grille bolts that were removed in step 5. to secure the RTR Grille to the core support.

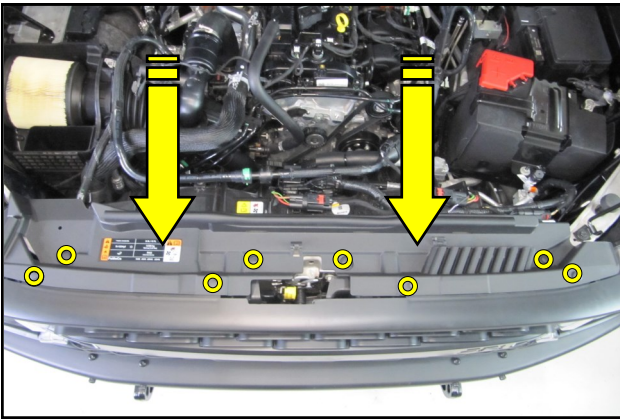

29. Reinstall the core support cover using the plastic rivets removed in step 3.

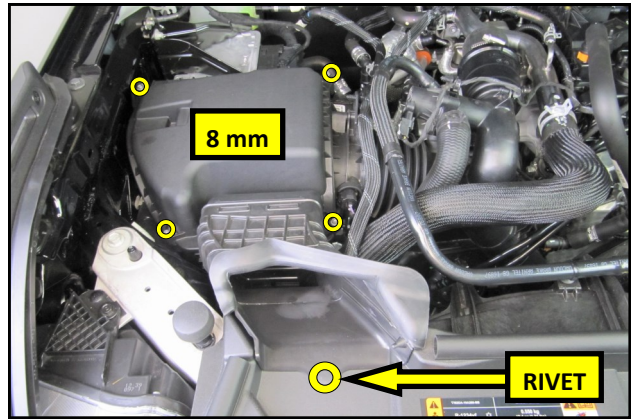

30. Reinstall the air box lid and tighten all 4 screws. Secure the inlet using the final rivet.



29. Clean the Badge recess on the Center Bar using isopropyl alcohol and a clean microfiber cloth .

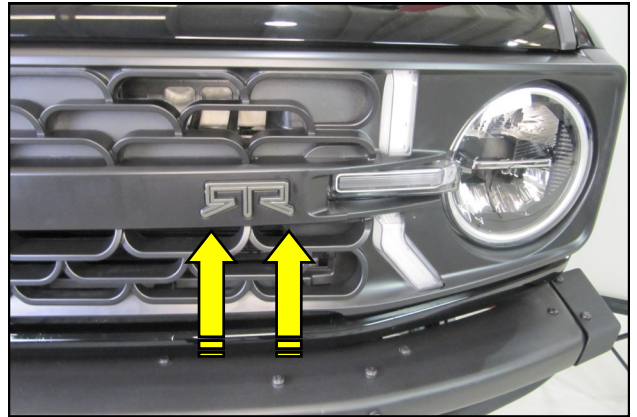

30. Peel the tape backer from the back of the RTR Badge and mount the Badge onto the Grille. Press firmly for 30 seconds.

Mode Description

- ◆ The RTR lights have 2 modes-High and Low. With the Parking lights on, they will be on High. With the headlights on, they will be automatically dimmed into Low.

Troubleshooting

- ◆ If lamps do not illuminate, unplug the connector, inspect the connector terminals, making sure they are straight, and reconnect.
- ◆ If there is still no function, make sure the light switch is turned to the parking or headlamp position. The lamps should be turned on any time the vehicle lights are illuminated.
- ◆ If LED Grille is illuminated, but headlamps are inoperable, confirm that the inline connector is connected on both sides, both to the factory harness and to the headlamp.

Care

- ◆ Clean the lamps using a mild solution of car soap and water.
- ◆ Do not use any harsh solvents or cleaners.
- ◆ Wipe the lenses dry using a clean microfiber cloth.
- ◆ Do not use the high pressure hose setting at the car wash or a pressure washer to clean the Lights.

THIS PAGE HAS BEEN INTENTIONALLY LEFT BLANK