



Labienhecha

INDEX

VEGAN →

EXTRAS →

TOP 10 - BEST-SELLERS →

ABOUT LABIENHECHA →

OUR WORKSHOP →

CLIENT AREA B2B →

CLIENT ACCOUNT

ORDER FORM



SOFTIES

VEGAN COLLECTION

The hit of 2023. A 100% vegan and plastic-free collection. Yes, you heard that right: it's a non-petroleum-derived material. No PVC or PU. Just 100% silicone and organic cotton. Waterproof, resistant, non-staining, anti-allergic and supersoft.

DISCOVER

BEST SELLER

THE ÁNGELAS

Our collection of buckets in 4 sizes and 10 colours.
They became a best seller from minute one.

DISCOVER



ANGELITA

DISCOVER →



ANGELINES

DISCOVER →



ÁNGELA

DISCOVER →



DOÑA ÁNGELA

DISCOVER →

WANTED

LAS JUANAS

Our tote collection in 3 sizes and 10 colours. You'll love their minimalist design and large capacity.

DISCOVER



JUANITA

DISCOVER →



JUANI

DISCOVER →



JUANA

DISCOVER →

SUPER PRACTICAL

THE FERNANDAS

Our collection of baguettes in 2 sizes and 10 colours. Practical, versatile and with that minimalist design that characterises us so much.

DISCOVER



FERNANDITA

DISCOVER →



FERNANDA

DISCOVER →

NEW!

LAS ADELAS

The latest silicone collection. Multi-position bags, superversatile, comfortable and with a design that will drive anyone crazy.

DISCOVER



ADELITA

DISCOVER →



ADELINA

DISCOVER →



ADELA

DISCOVER →

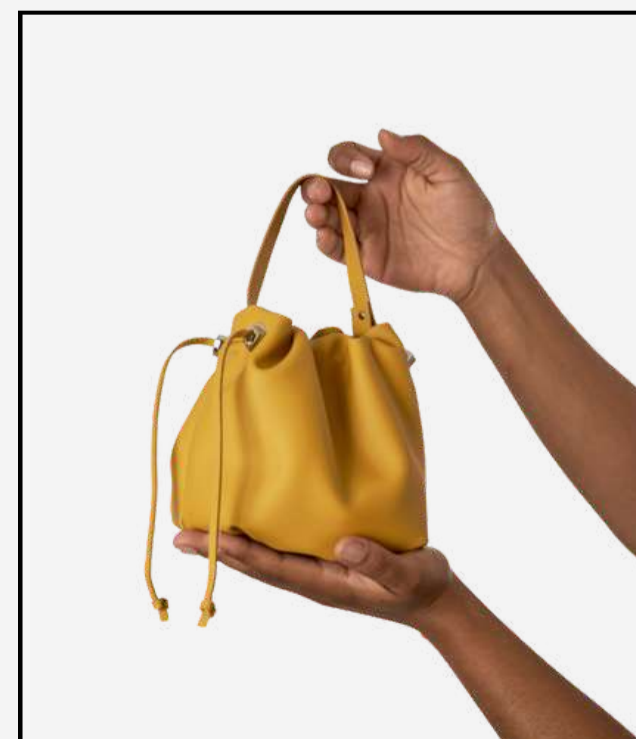
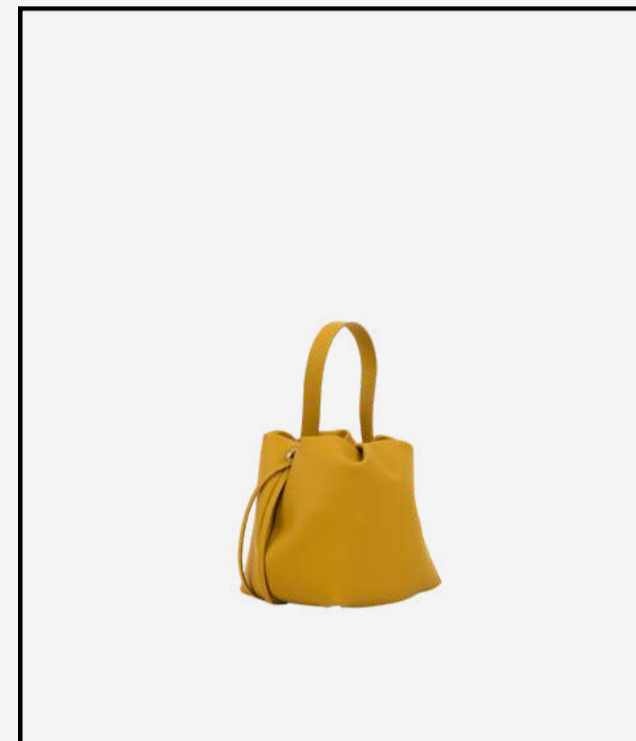
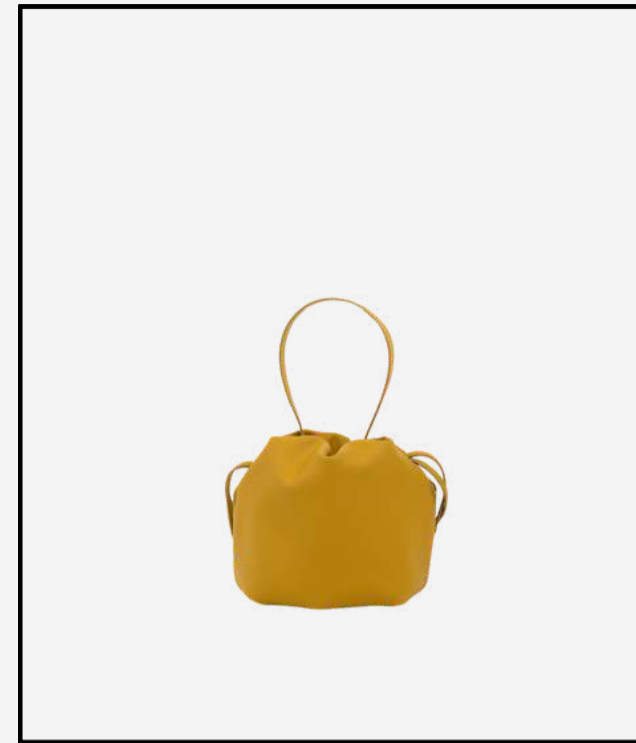
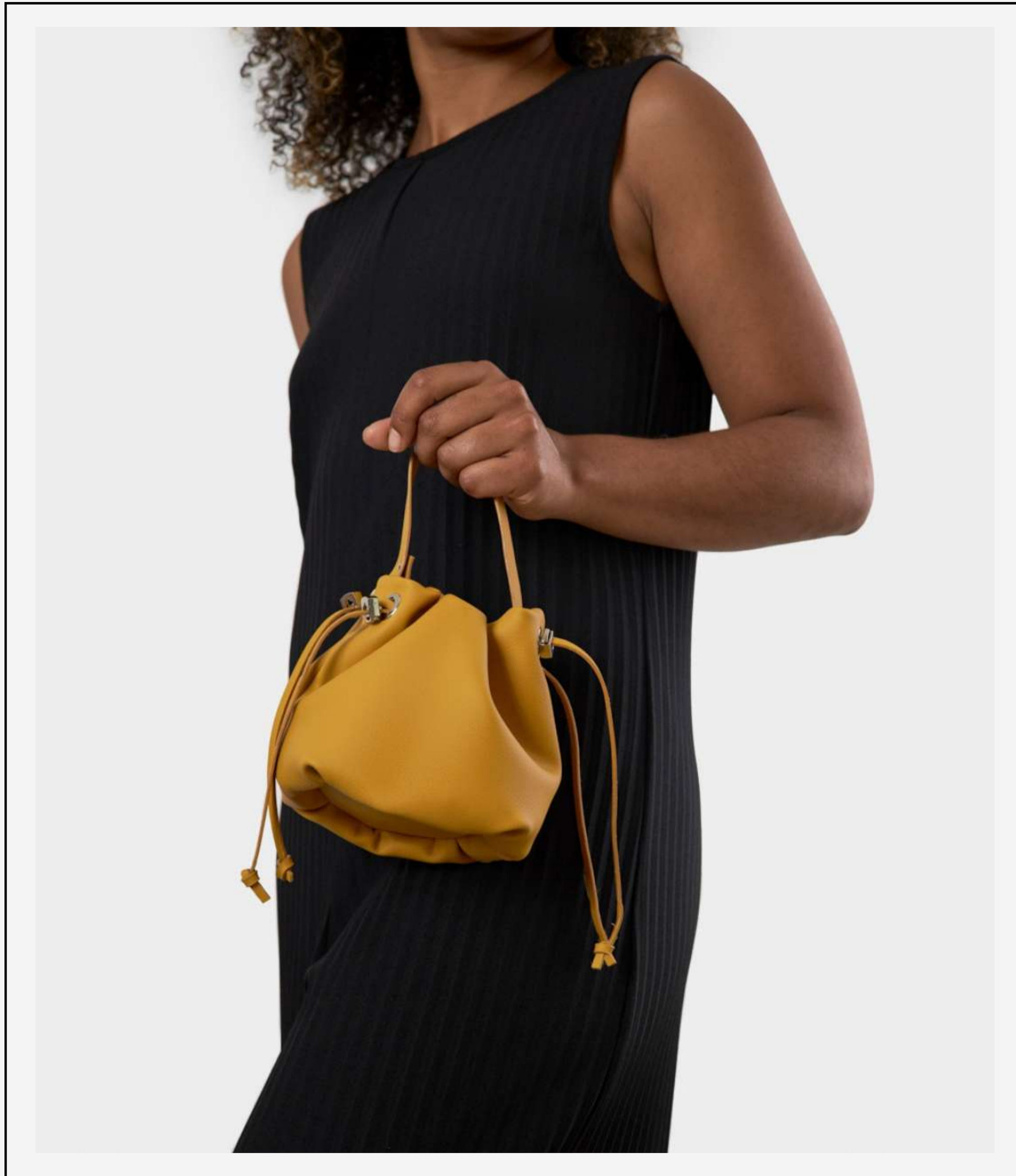

BEST SELLER

ANGELITA

The smallest of the family of four ("Las Ángelas"). Small but tough. To carry the basics without sacrificing design.

DISCOVER

BEST SELLER

ANGELITA

- Magnet fastener + adjustable cord
- Outside made of vegan Biomaterial 100% silicone and plastic-free
- Inside made of very soft organic cotton canvas with GOT certificate
- Waterproof, very resistant to scratches and stains, hypoallergenic, odorless...
- Interchangeable 30 cm hand strap and 120 cm crossbody strap included
- Reinforced base to keep its shape
- Extra straps available: 60 cm, 70 cm, 80 cm, 100 cm, 120 cm or 140 cm

SHOP

EXTRAS

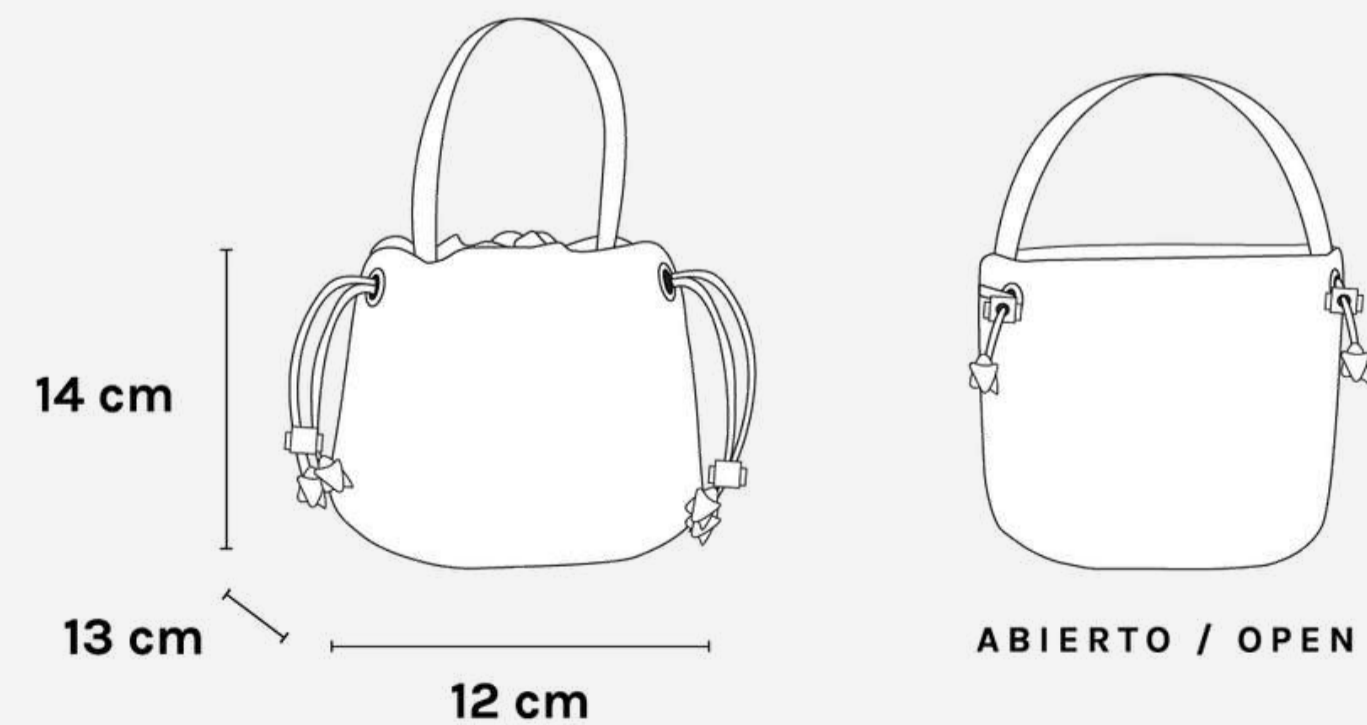

BLACK



OLIVE GREEN



YELLOW



SKY BLUE



LEMON CREAM

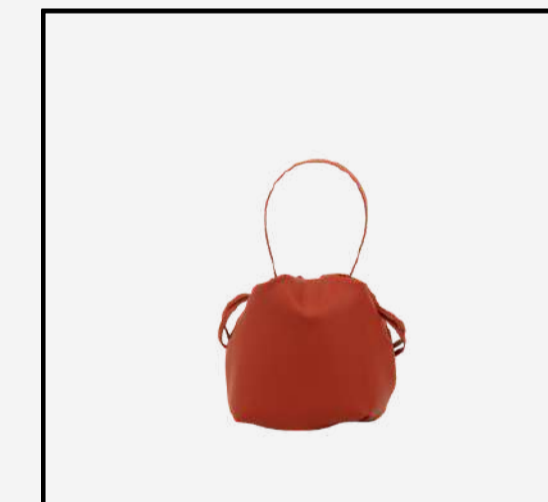

BRICK RED

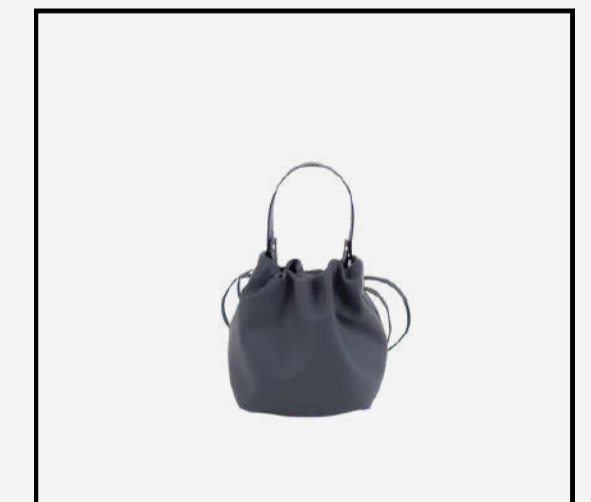

FANCY GREY

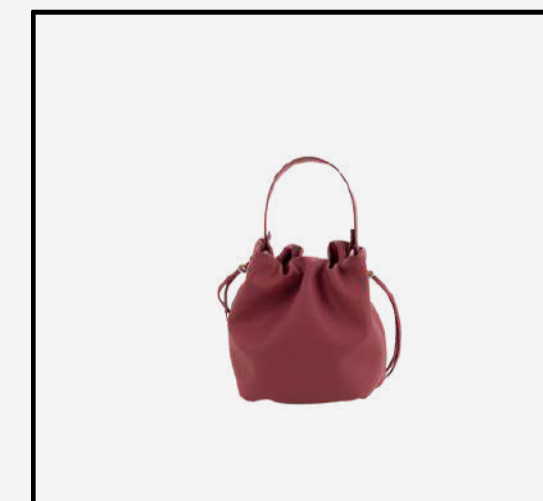

MAROON



STONE GREY



MOSS BLUE



POSITIONS | * The model is 1.70 m tall

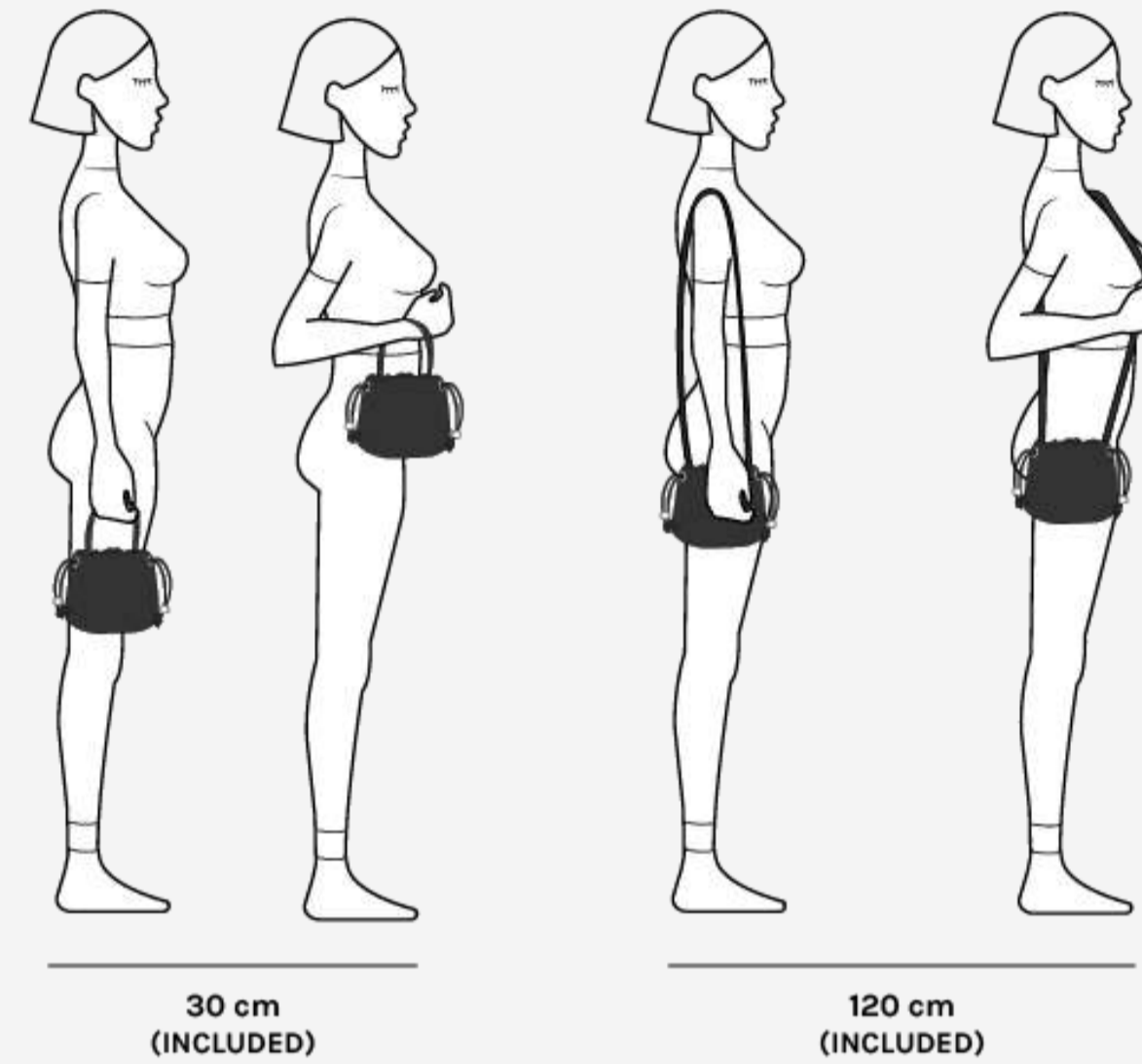

BEST SELLER

ANGELITA

SHOP

RETAIL PRICE: 139,95€

*Sign in to your account to see your wholesale price

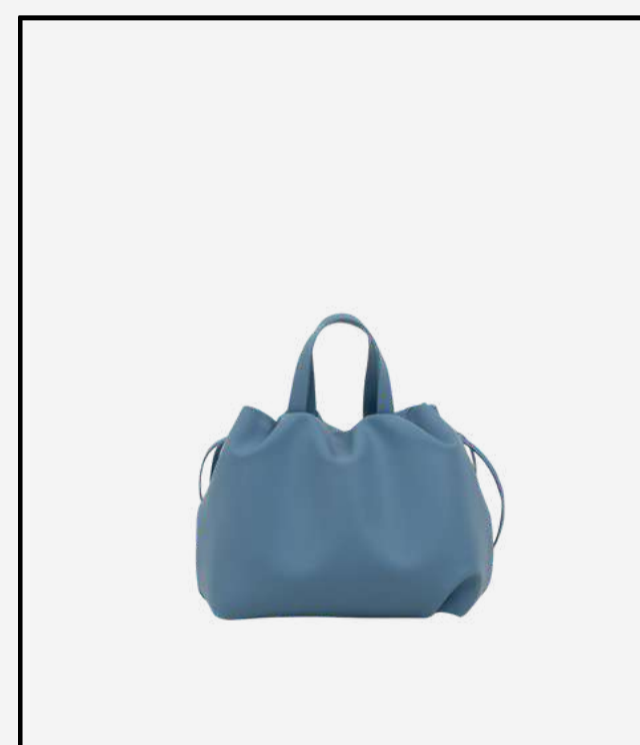
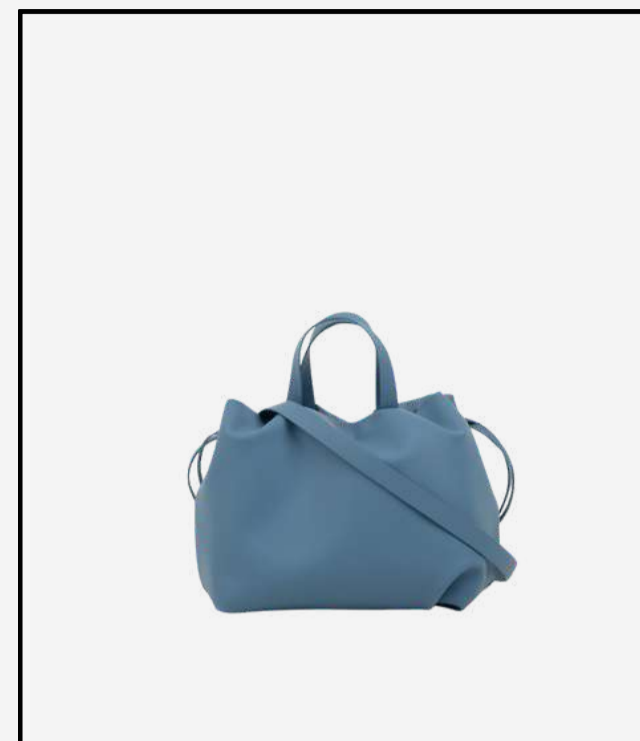
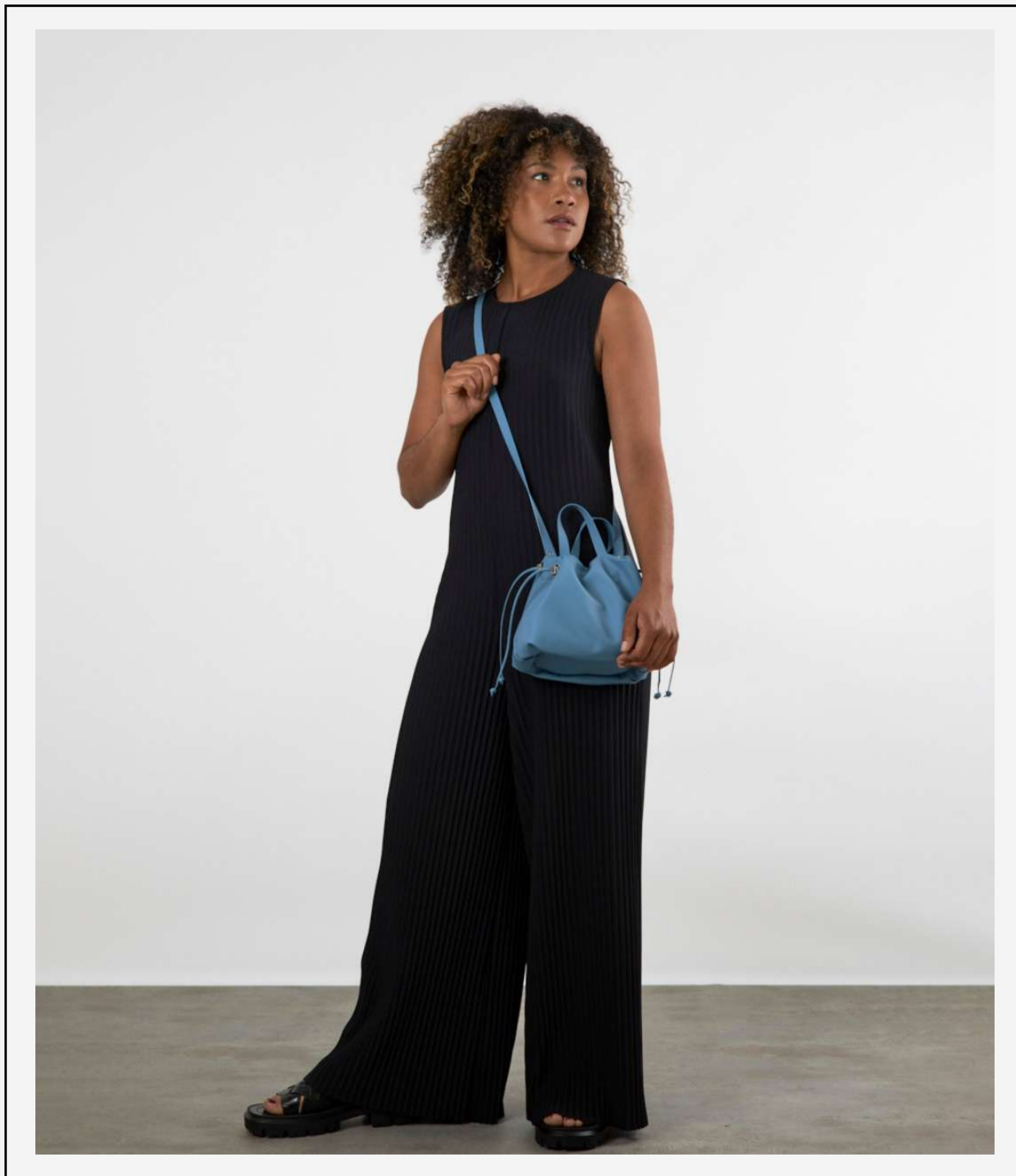

BEST SELLER

ANGELINES

Angelines is a perfect everyday bucket with a very pure, original and minimalist design. Super practical size and very light weight.

DISCOVER

BEST SELLER

ANGELINES

- Magnet fastener + adjustable strap
- Outside made of vegan Biomaterial 100% silicone and plastic-free
- Inside made of very soft organic cotton canvas with GOT certificat
- Waterproof, very resistant to scratches and stains, hypoallergenic, odorless...
- Two integrated 30 cm handles also a strap of 120 cm included (interchangeable)
- Reinforced base to keep its shape
- Extra straps available: 60 cm, 70 cm, 80 cm, 100 cm, 120 cm or 140 cm

SHOP

EXTRAS

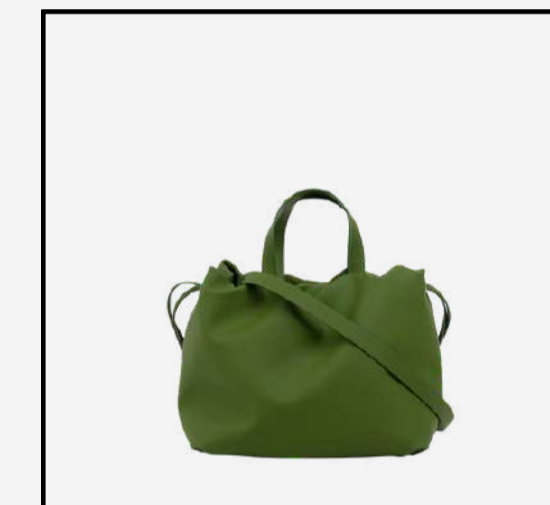
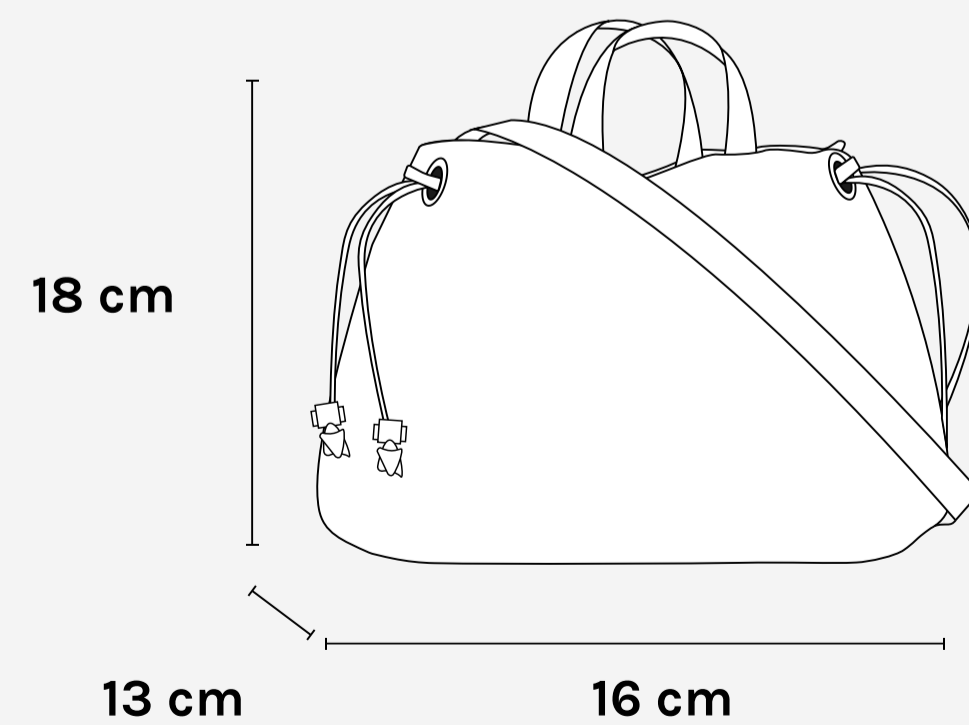

OLIVE GREEN

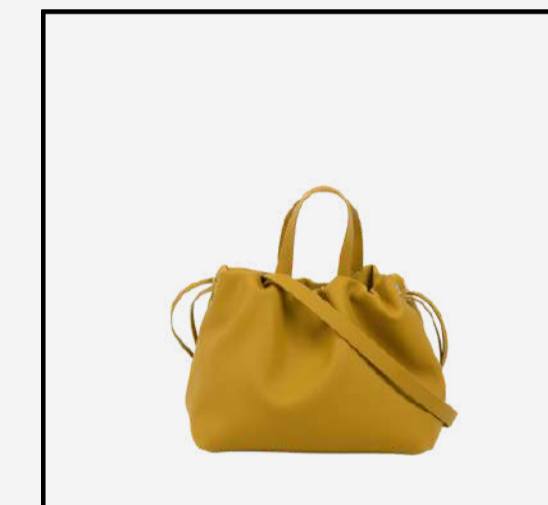

YELLOW

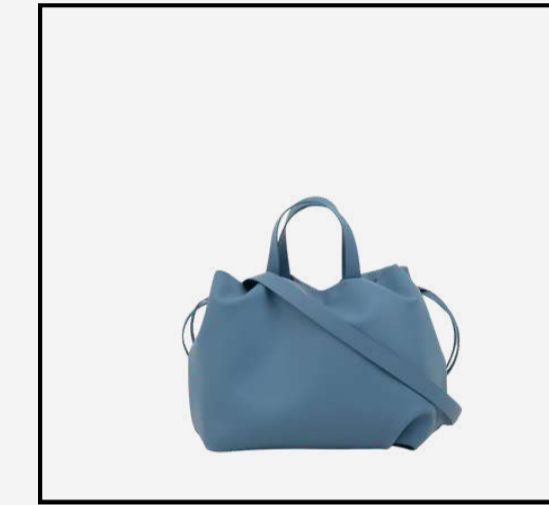

SKY BLUE

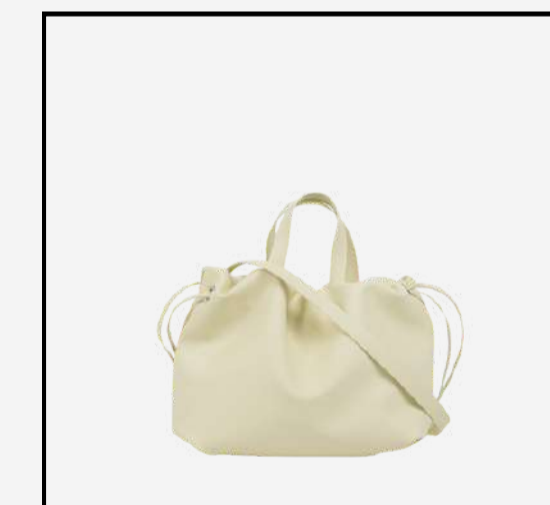

LEMON CREAM

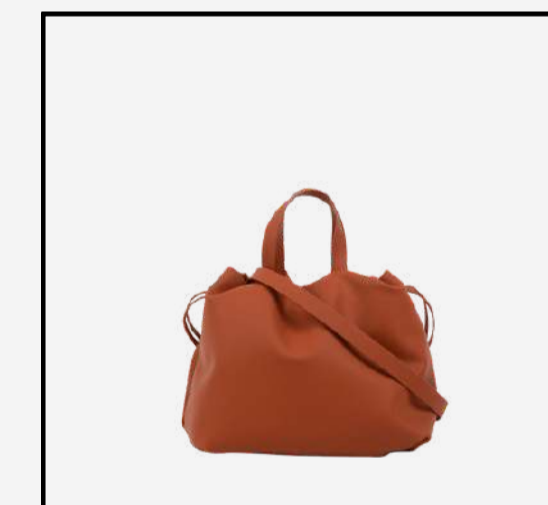

BRICK RED

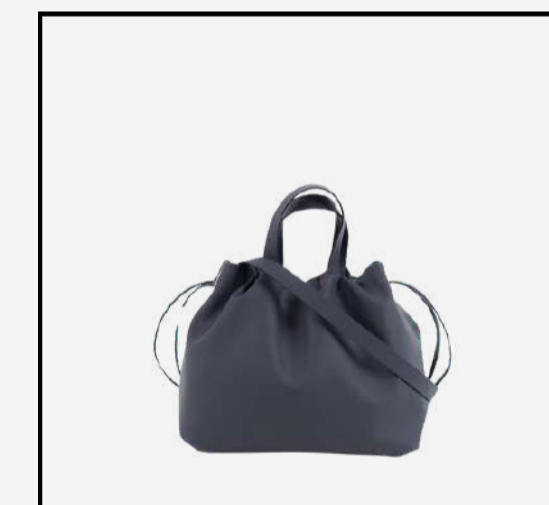

FANCY GREY

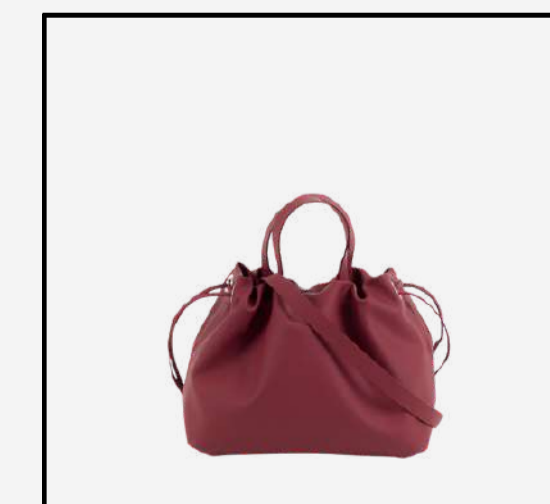

MAROON

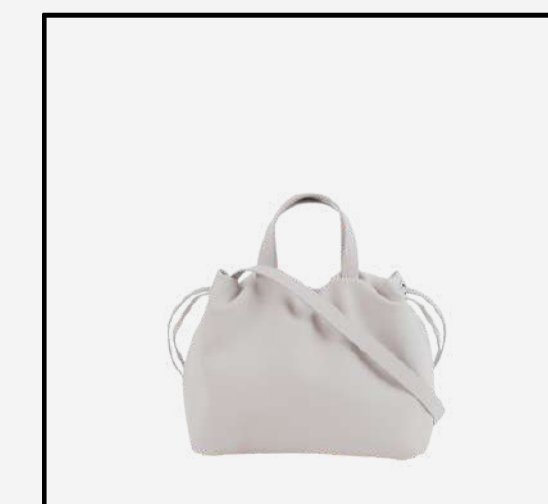

STONE GREY

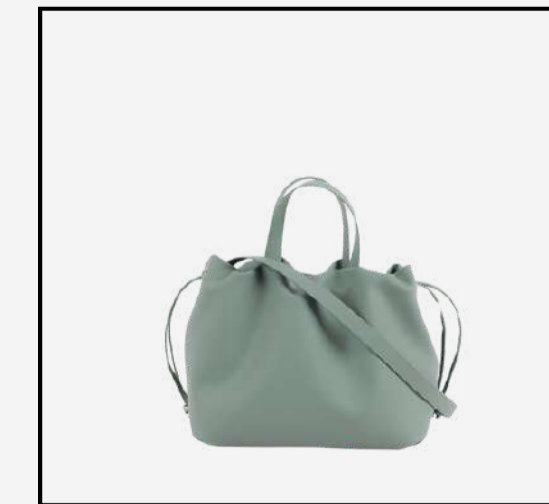

MOSS BLUE



BLACK



POSITIONS | * The model is 1.70 m tall

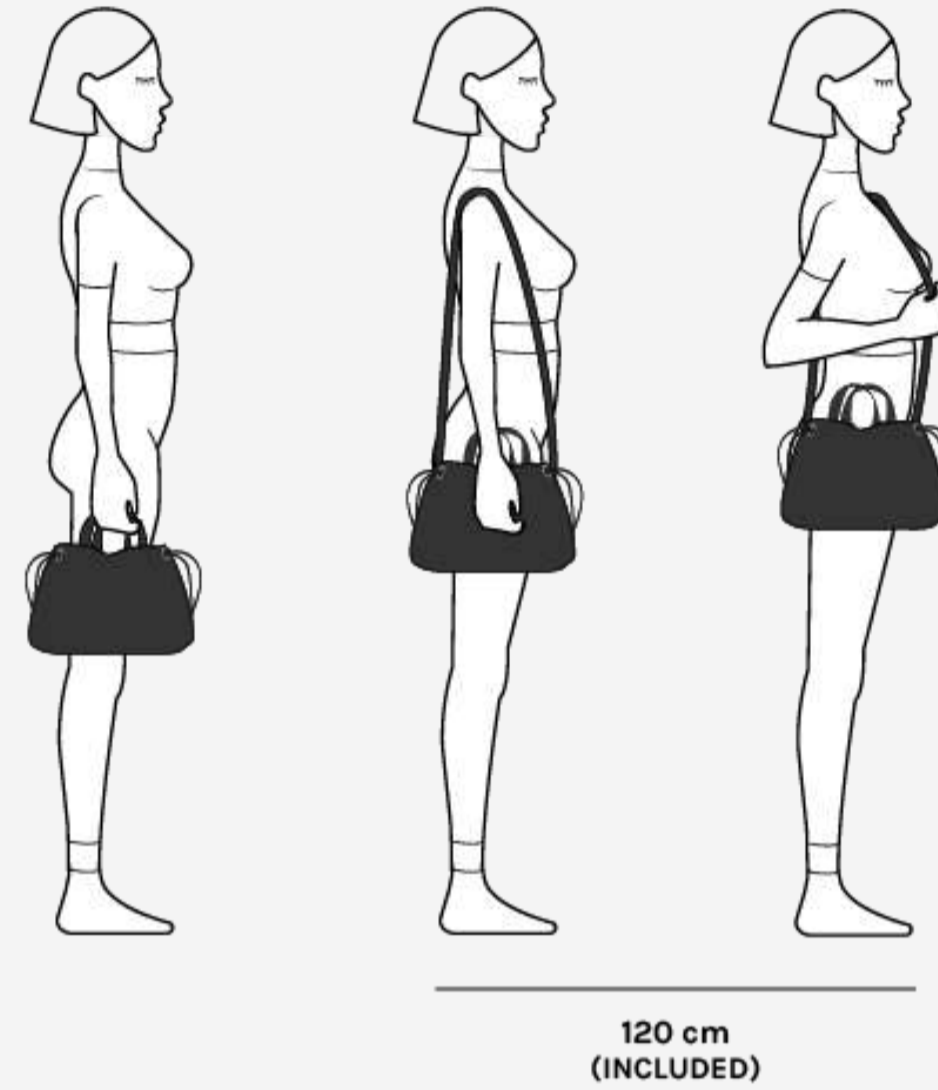

BEST SELLER

ANGELINES

SHOP

RETAIL PRICE: 179,95€

*Sign in to your account to see your wholesale price

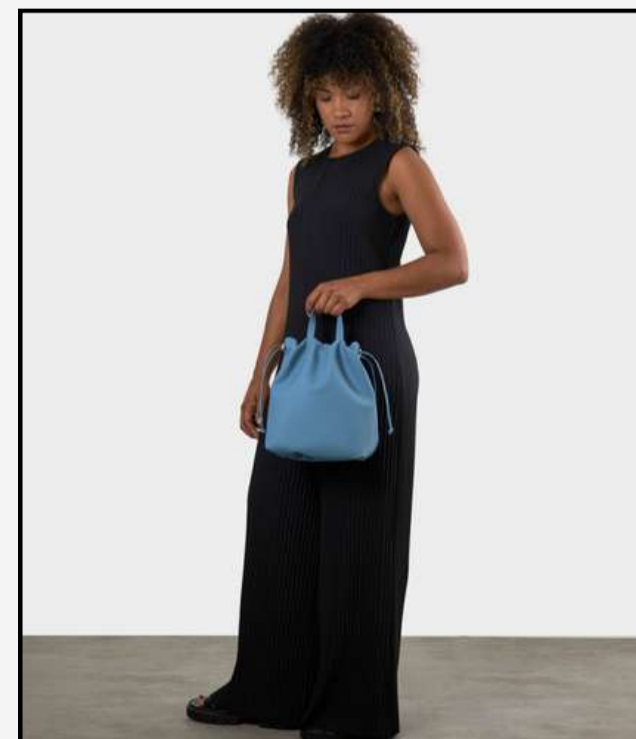
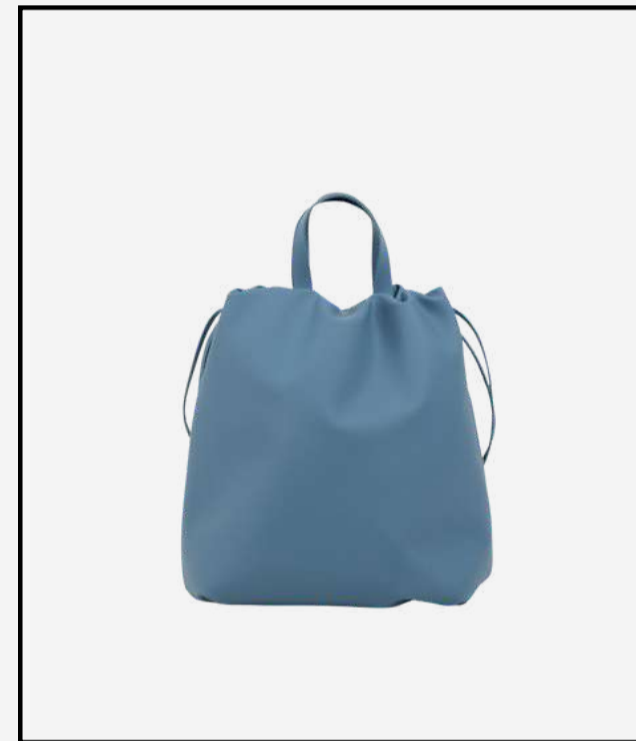
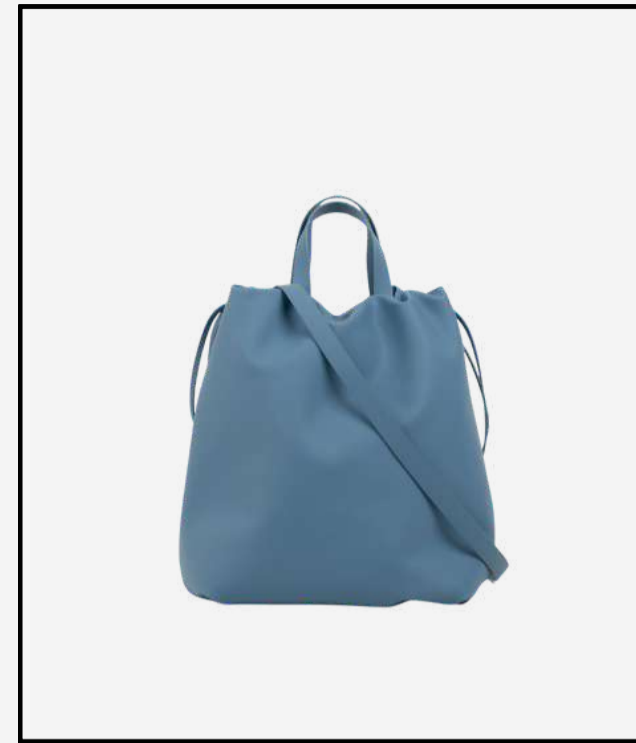

BEST SELLER

ÁNGELA

Bucket bag with one of those sizes that makes life easier without compromising on a super-original, simple and minimalist design. Practical and lightweight are its two surnames.

DISCOVER

BEST SELLER

ÁNGELA

- Magnet fastener + adjustable strap
- Outside made of vegan Biomaterial 100% silicone and plastic-free
- Inside made of very soft organic cotton canvas with GOT certificate
- Waterproof, very resistant to scratches and stains, hypoallergenic, odorless...
- Two integrated 30 cm handles also a strap of 120 cm included (interchangeable)
- Reinforced base to keep its shape
- Extra straps available: 60 cm, 70 cm, 80 cm, 100 cm, 120 cm or 140 cm

SHOP

EXTRAS

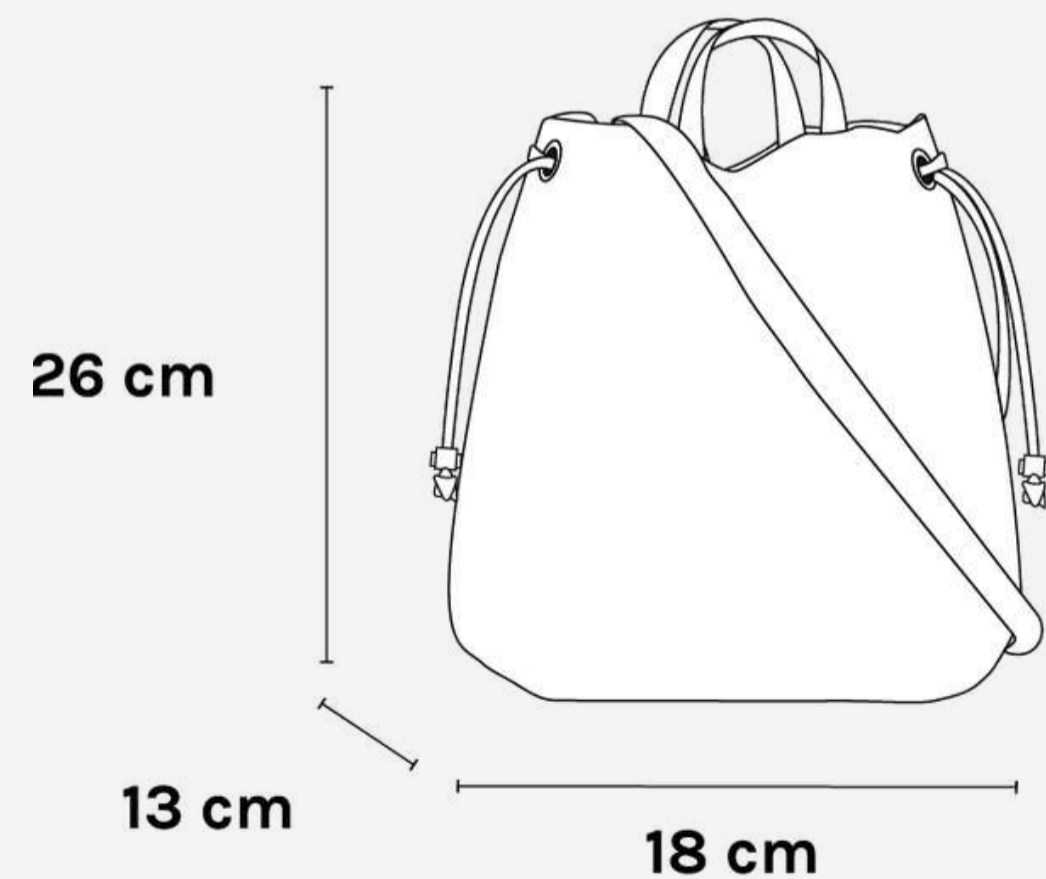

BLACK



OLIVE GREEN

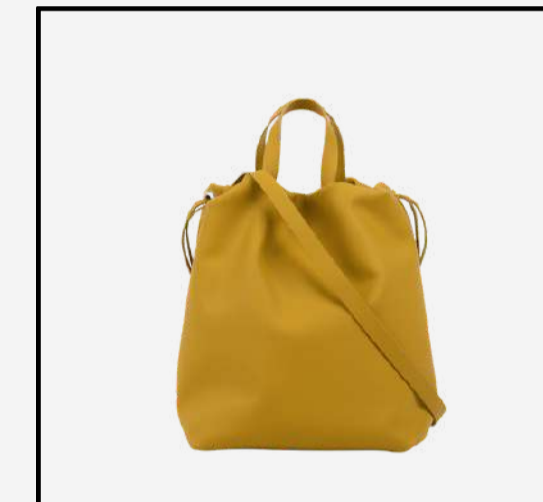

YELLOW



SKY BLUE



LEMON CREAM

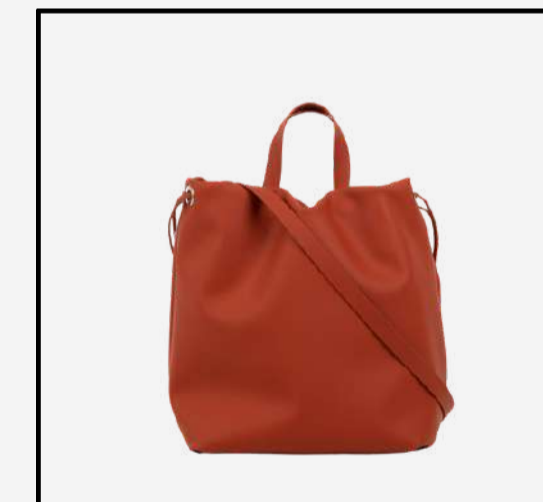

BRICK RED



FANCY GREY

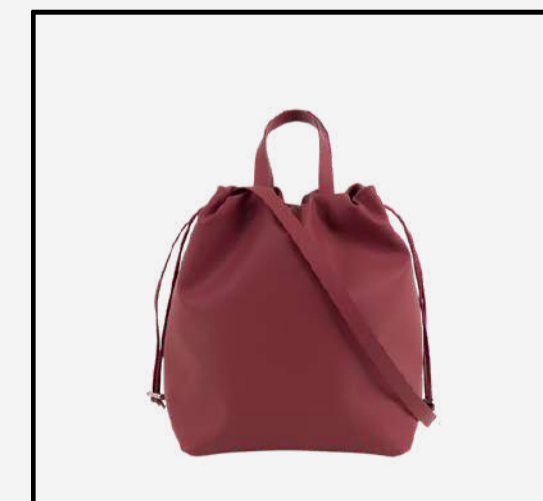

MAROON



STONE GREY



MOSS BLUE



POSITIONS | * The model is 1.70 m tall

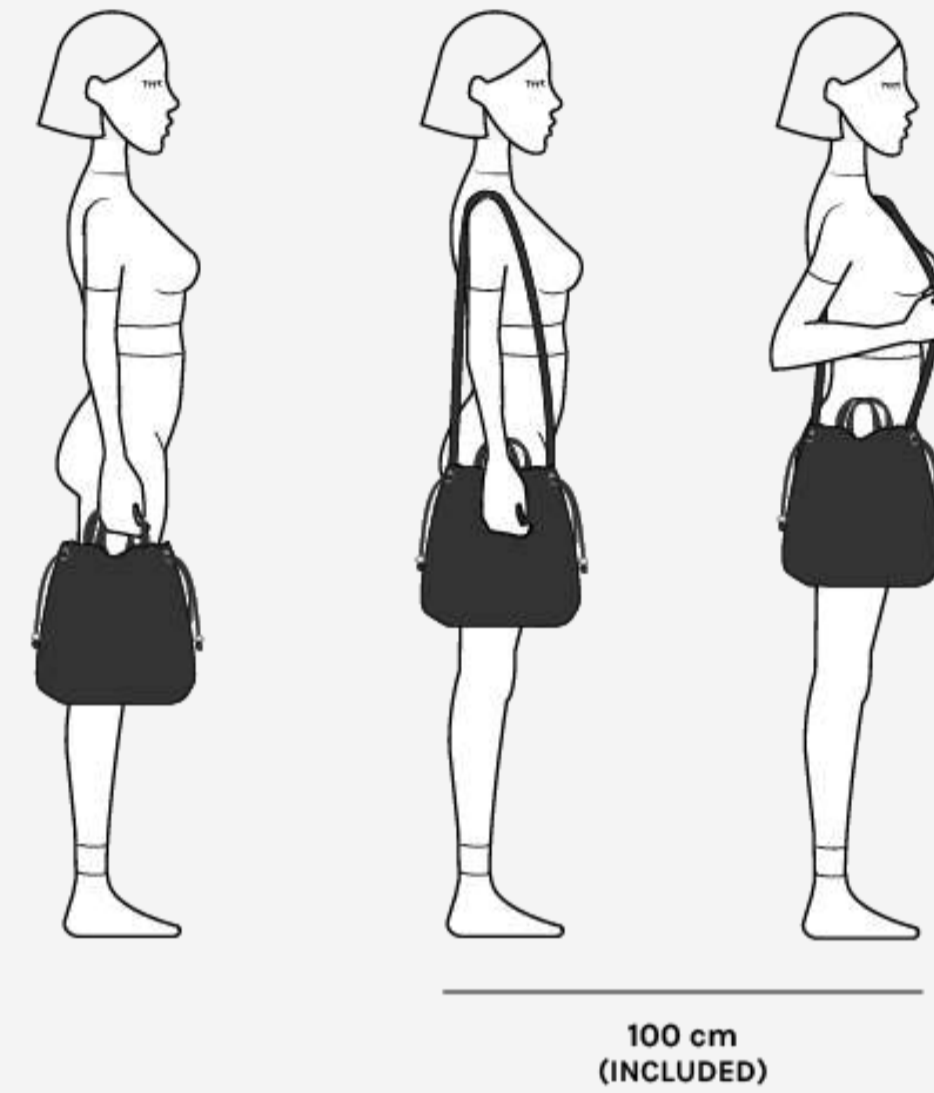

BEST SELLER

ÁNGELA

SHOP

RETAIL PRICE: 239,95€

*Sign in to your account to see your wholesale price



BEST SELLER

DOÑA ÁNGELA

Bucket bag / maxi shopper. The perfect bag for those looking for extra space without sacrificing design, it's also practical and lightweight!

DISCOVER

BEST SELLER

DOÑA ÁNGELA

- Magnet fastener + adjustable strap
- Outside made of vegan Biomaterial 100% silicone and plastic-free
- Inside made of very soft organic cotton canvas with GOT certificate
- Waterproof, very resistant to scratches and stains, hypoallergenic, odorless...
- Two integrated 30 cm handles also a strap of 120 cm included (interchangeable)
- Reinforced base to keep its shape
- Extra straps available: 60 cm, 70 cm, 80 cm, 100 cm, 120 cm or 140 cm

SHOP

EXTRAS

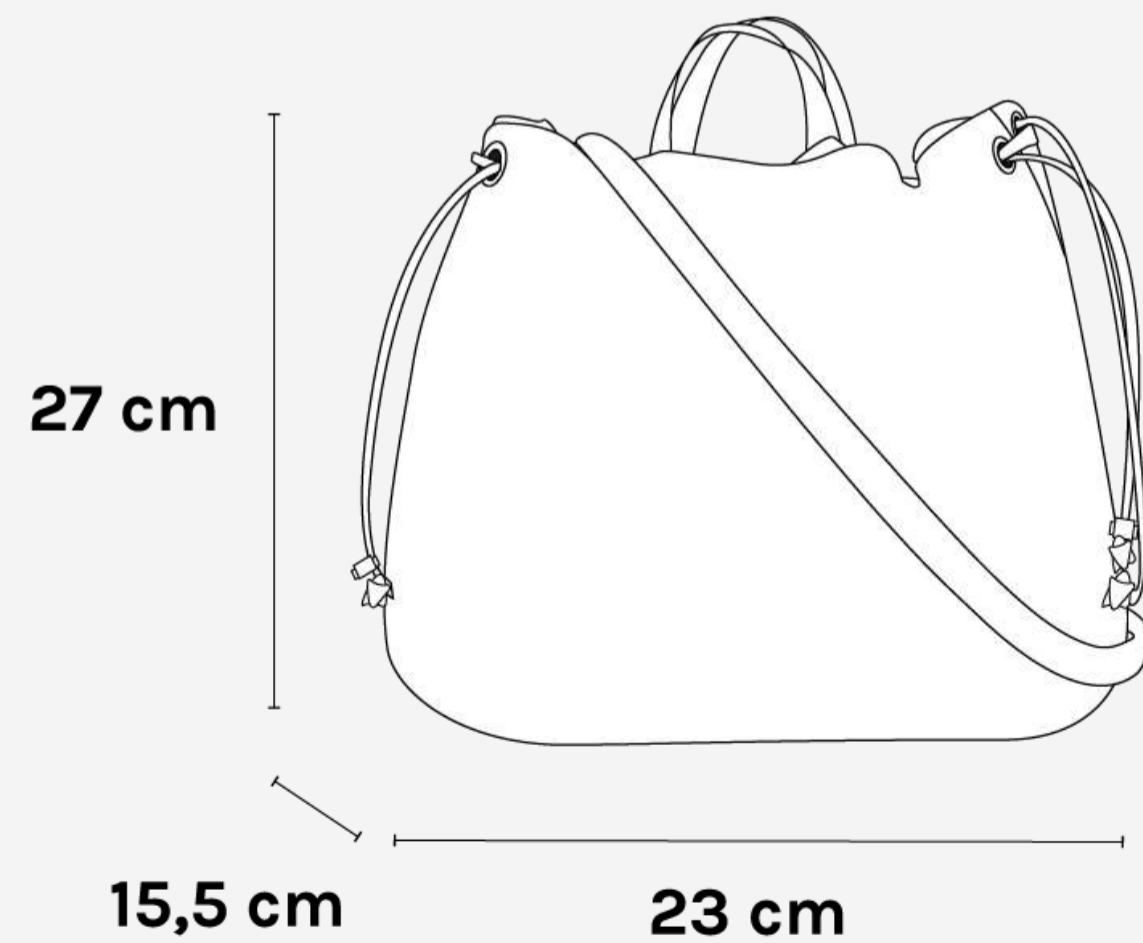

BLACK



OLIVE GREEN



YELLOW



SKY BLUE



LEMON CREAM

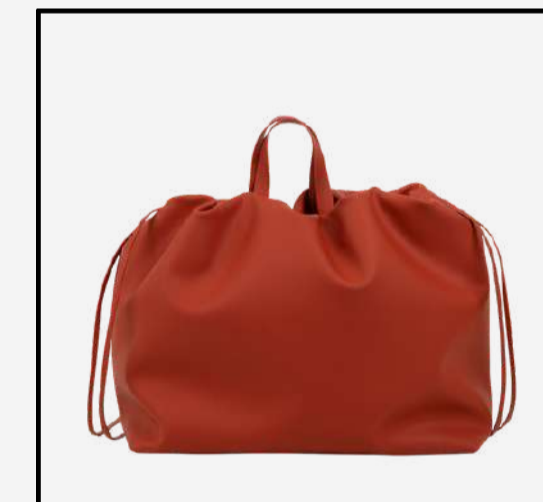

BRICK RED



FANCY GREY



MAROON



STONE GREY



MOSS BLUE



POSITIONS | * The model is 1.70 m tall

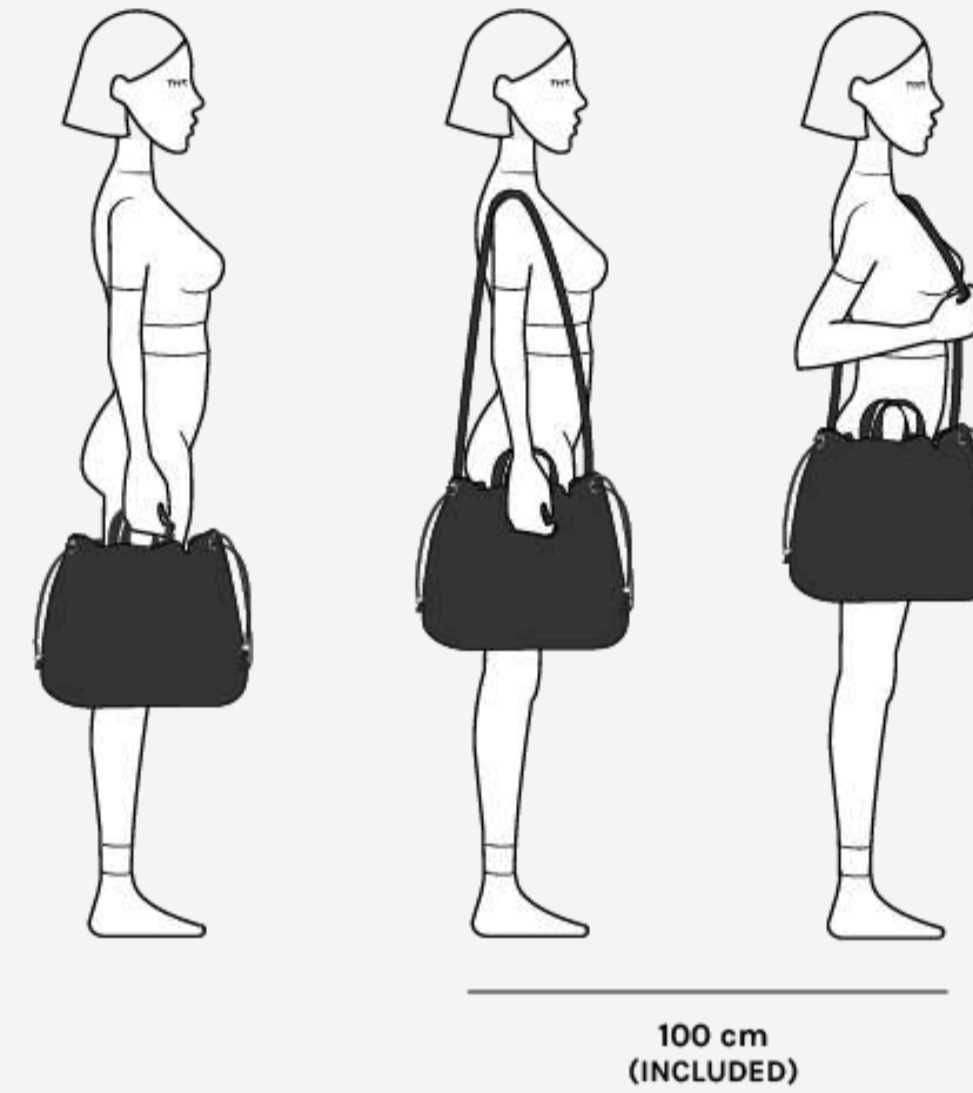

BEST SELLER

DOÑA ÁNGELA

SHOP

RETAIL PRICE: 269,95€

*Sign in to your account to see your wholesale price

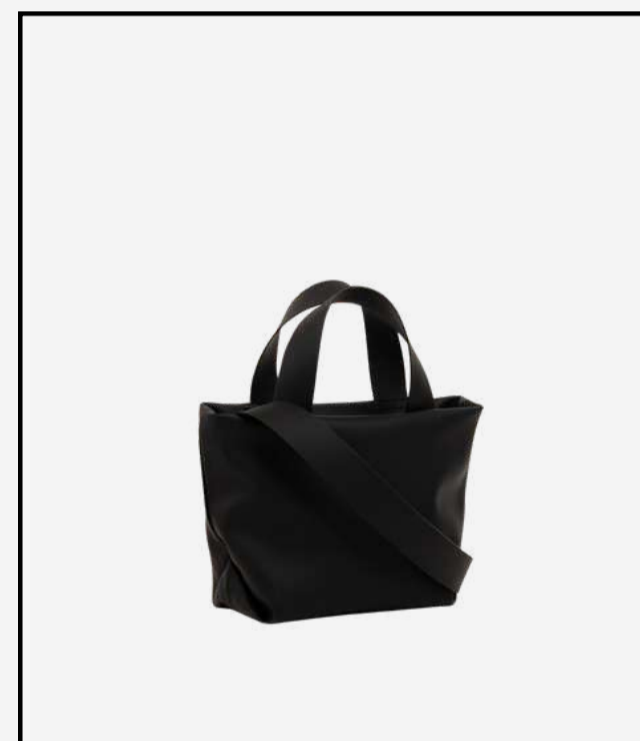
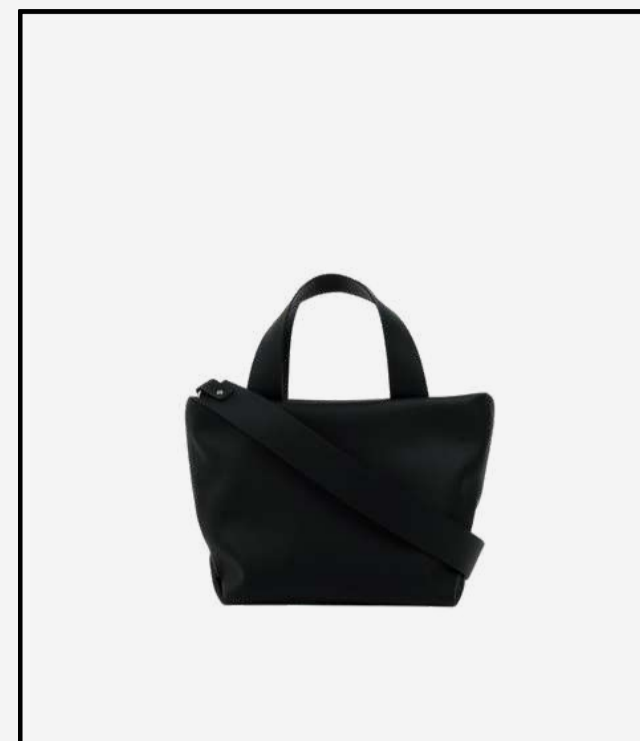

BEST SELLER

JUANITA

One of those bags that won't go unnoticed. Soft, smooth and hard-wearing, it's a must-have for everyday use! Small but mighty.

DISCOVER

BEST SELLER

JUANITA

- Zip fastener YKK
- Outside made of vegan Biomaterial 100% silicone and plastic-free
- Inside made of very soft organic cotton canvas with GOT certificate
- Waterproof, very resistant to scratches and stains, hypoallergenic, odorless...
- Two integrated 30 cm handles also a strap of 100 cm included (interchangeable)
- Reinforced base to keep its shape
- Extra straps available: 60 cm, 70 cm, 80 cm, 100 cm, 120 cm or 140 cm

SHOP

EXTRAS

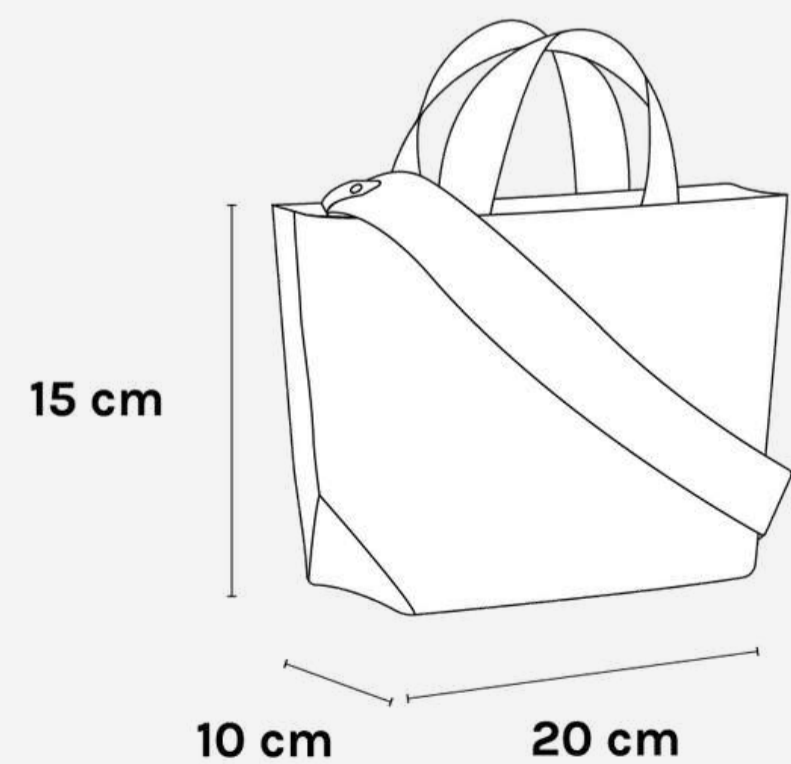

BLACK



OLIVE GREEN



YELLOW



SKY BLUE



LEMON CREAM

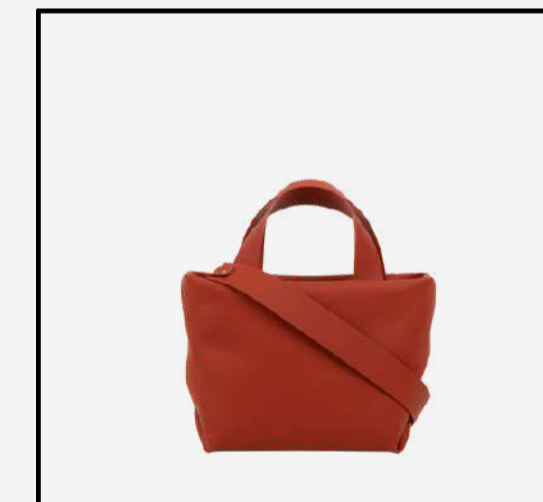

BRICK RED

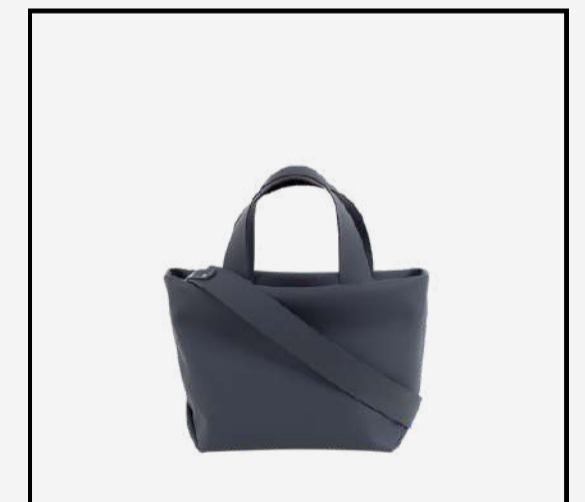

FANCY GREY

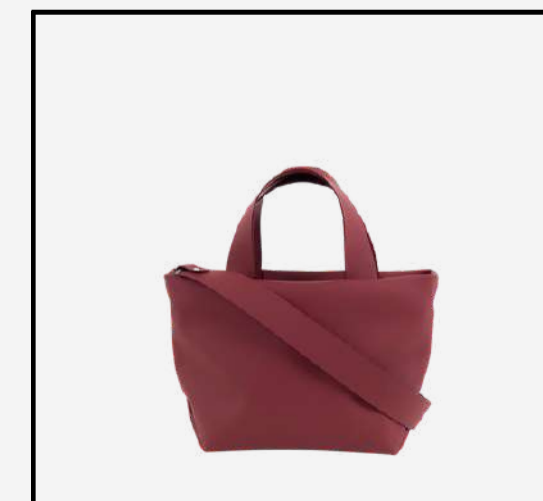

MAROON



STONE GREY



MOSS BLUE



POSITIONS | * The model is 1.70 m tall

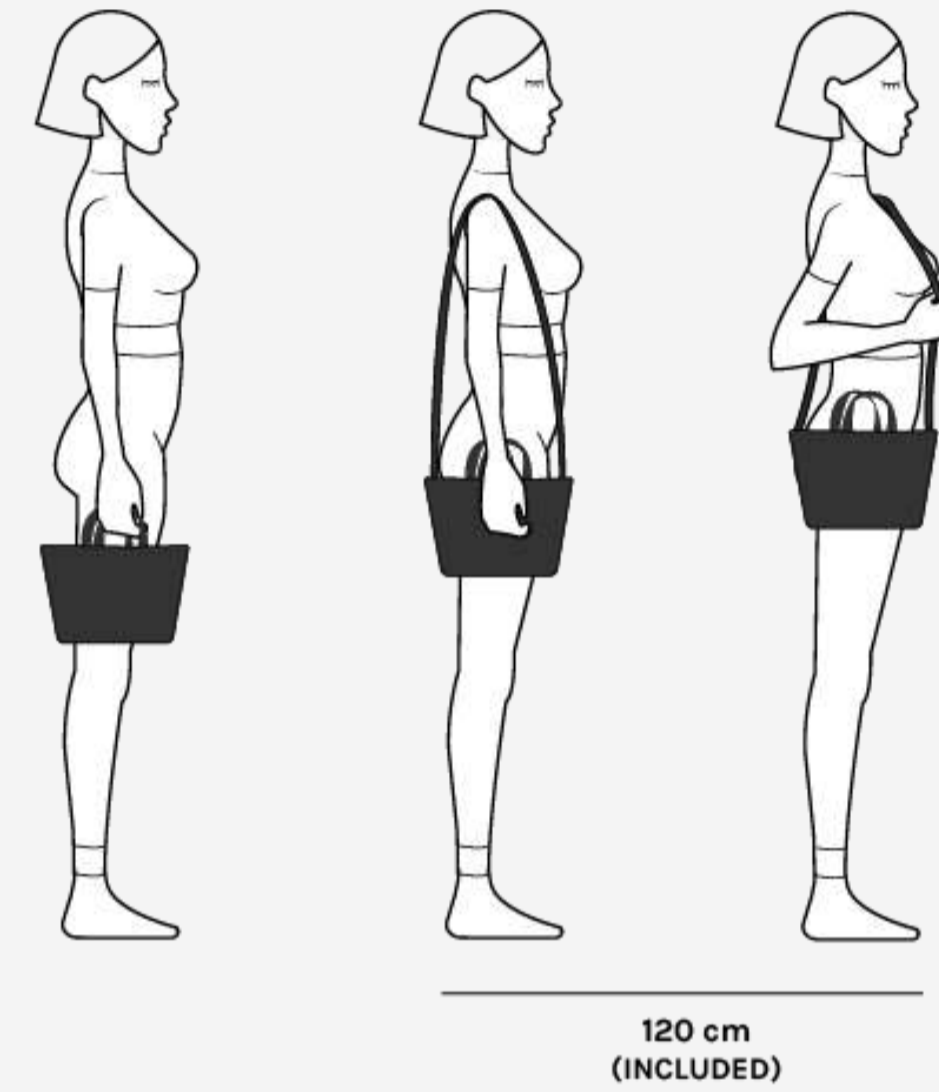

BEST SELLER

JUANITA

SHOP

RETAIL PRICE: 219,95€

*Sign in to your account to see your wholesale price

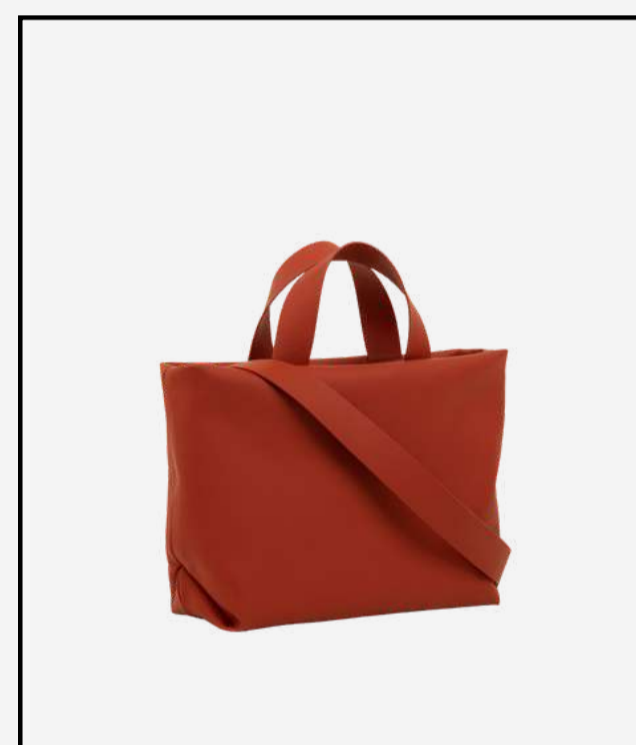

VEGAN

JUANI

A bag that combines softness, strength and versatility in a design with minimalist lines. With a medium size, but with a large capacity, it is the perfect ally for any occasion!

DISCOVER

VEGAN

JUANI

- Zip fastener YKK
- Outside made of vegan Biomaterial 100% silicone and plastic-free
- Inside made of very soft organic cotton canvas with GOT certificate
- Waterproof, very resistant to scratches and stains, hypoallergenic, odorless...
- Two integrated 30 cm handles also a strap of 100 cm included (interchangeable)
- Reinforced base to keep its shape
- Extra straps available: 60 cm, 70 cm, 80 cm, 100 cm, 120 cm or 140 cm

SHOP

EXTRAS

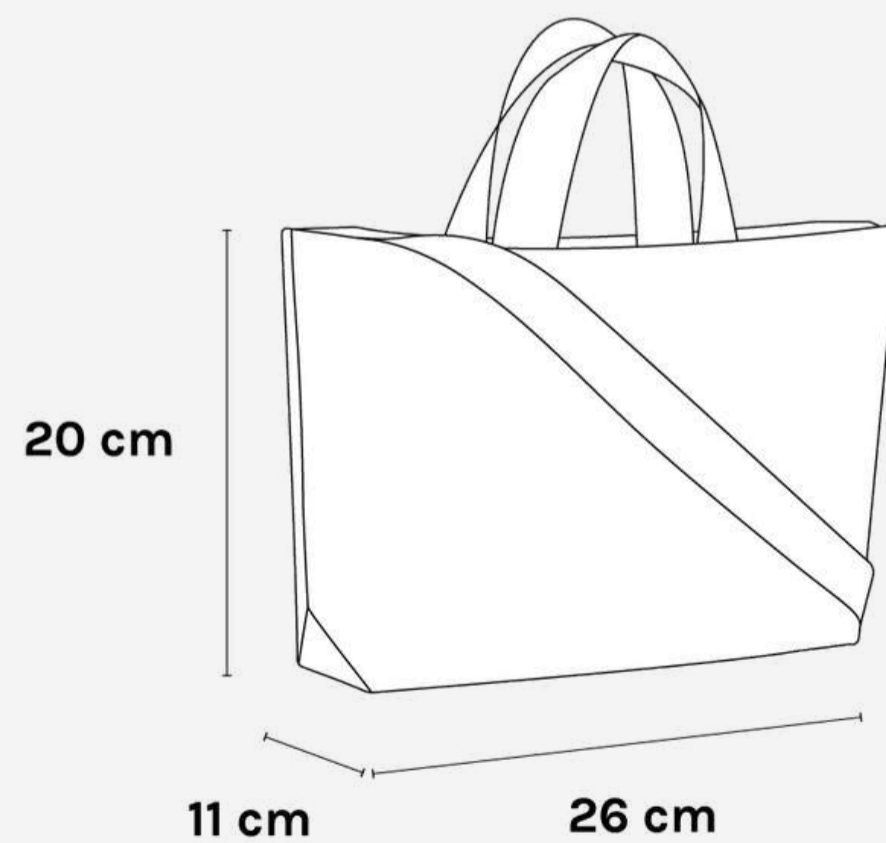

BLACK



OLIVE GREEN



YELLOW



SKY BLUE



LEMON CREAM



BRICK RED



FANCY GREY



MAROON



STONE GREY



MOSS BLUE



POSITIONS | * The model is 1.70 m tall

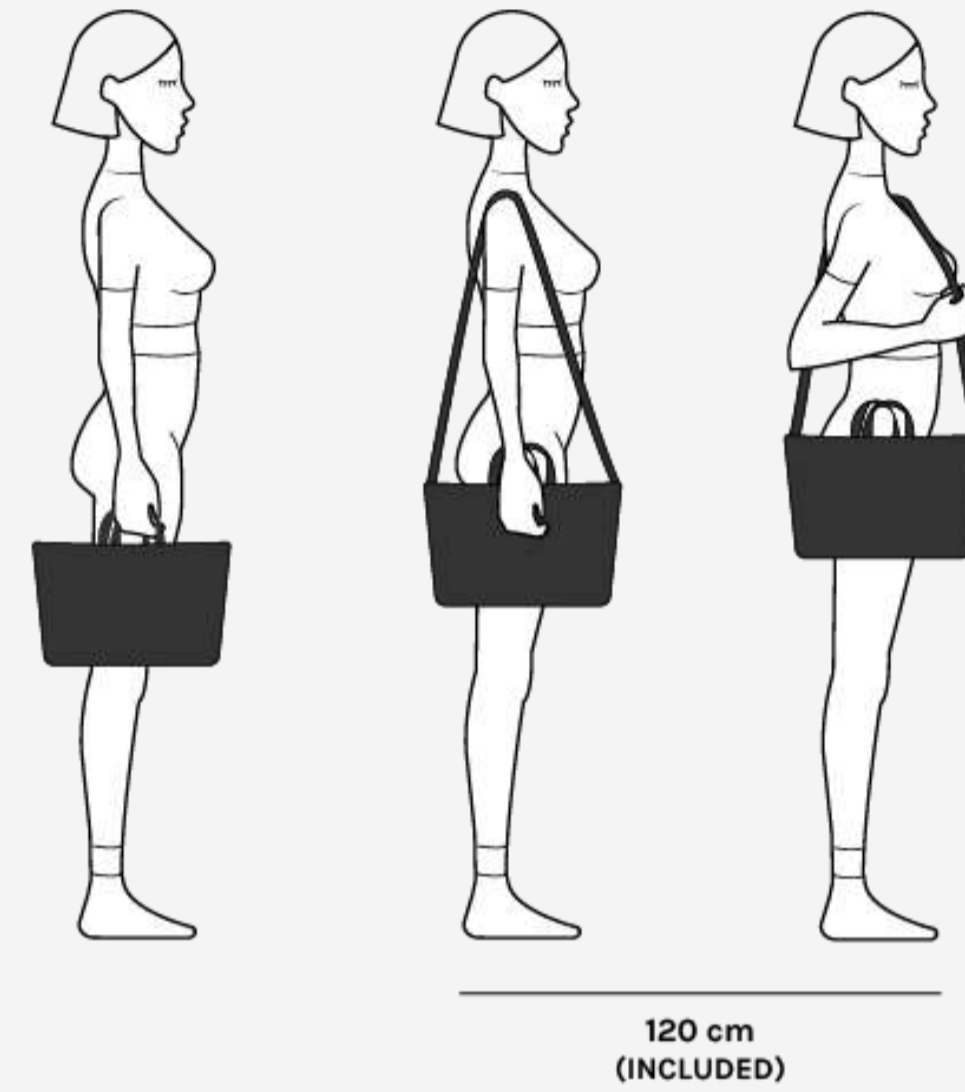

VEGAN

JUANI

SHOP

RETAIL PRICE: 249,95€

*Sign in to your account to see your wholesale price

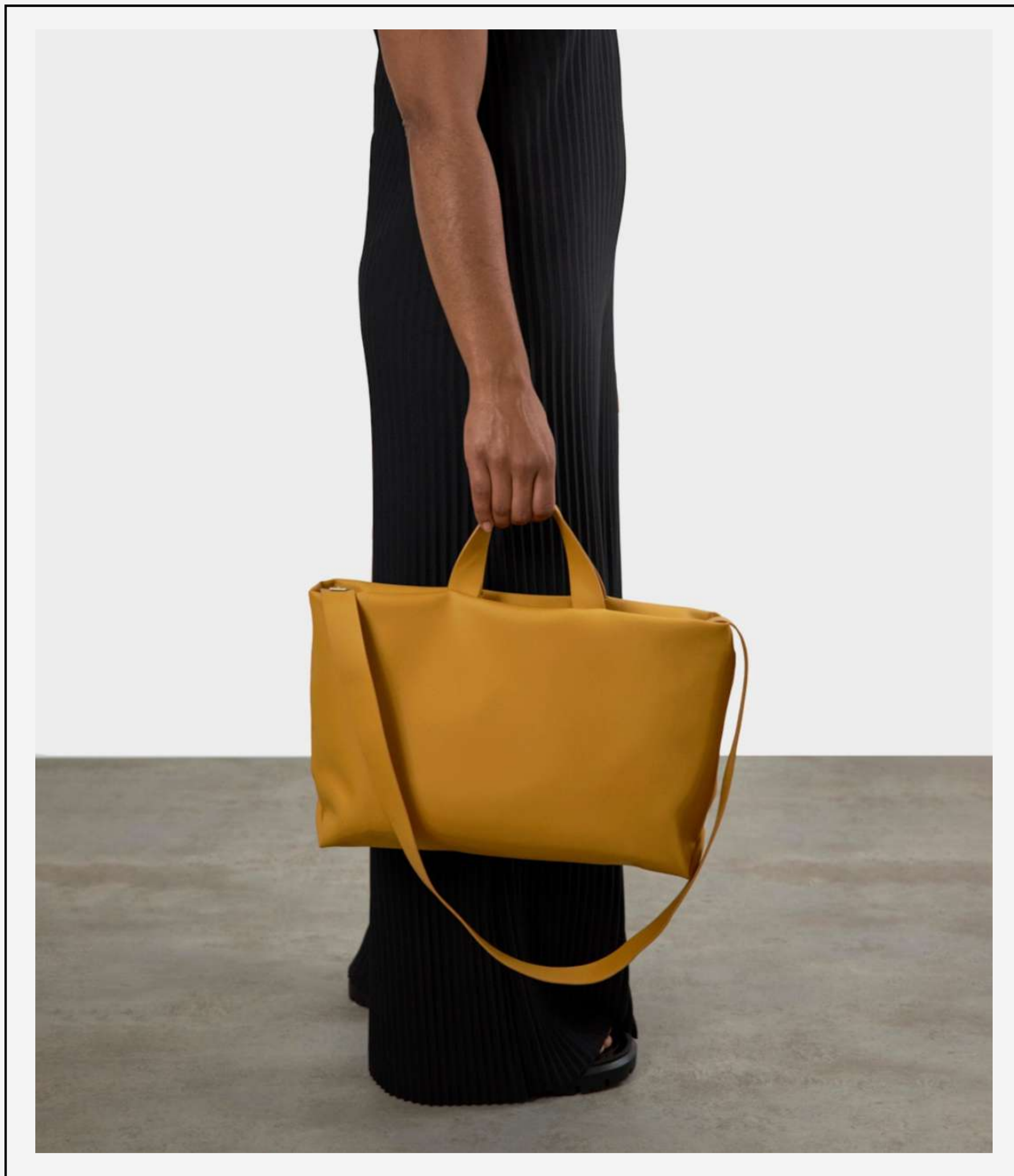

VEGAN

JUANA

Juana, the maxi bag for those who are looking for that extra space. Soft, resistant and versatile with tons of capacity, perfect for the office and everyday life!

DISCOVER

VEGAN

JUANA

- Zip fastener YKK
- Outside made of vegan Biomaterial 100% silicone and plastic-free
- Inside made of very soft organic cotton canvas with GOT certificate
- Waterproof, very resistant to scratches and stains, hypoallergenic, odorless...
- Two integrated 30 cm handles also a strap of 100 cm included (interchangeable)
- Reinforced base to keep its shape
- Extra straps available: 60 cm, 70 cm, 80 cm, 100 cm, 120 cm or 140 cm

SHOP

EXTRAS

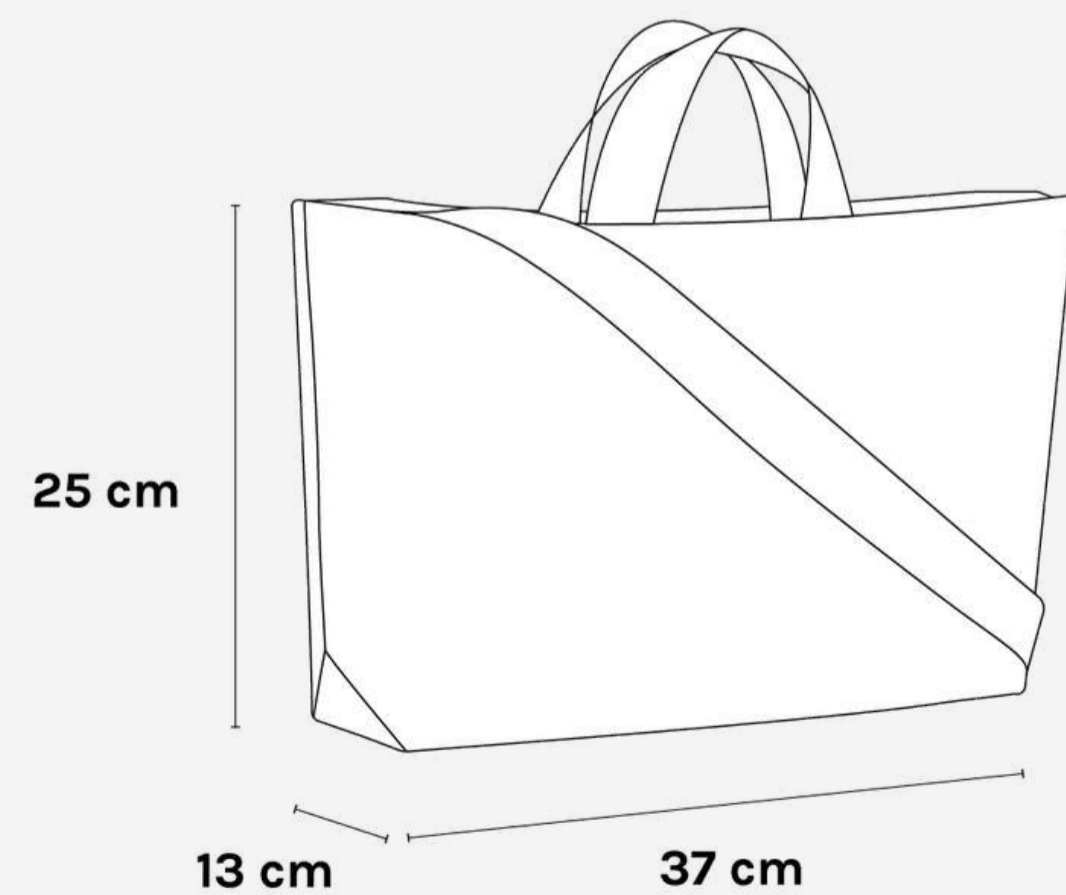

BLACK



OLIVE GREEN



YELLOW



SKY BLUE



LEMON CREAM



BRICK RED



FANCY GREY



MAROON



STONE GREY



MOSS BLUE



POSITIONS | * The model is 1.70 m tall

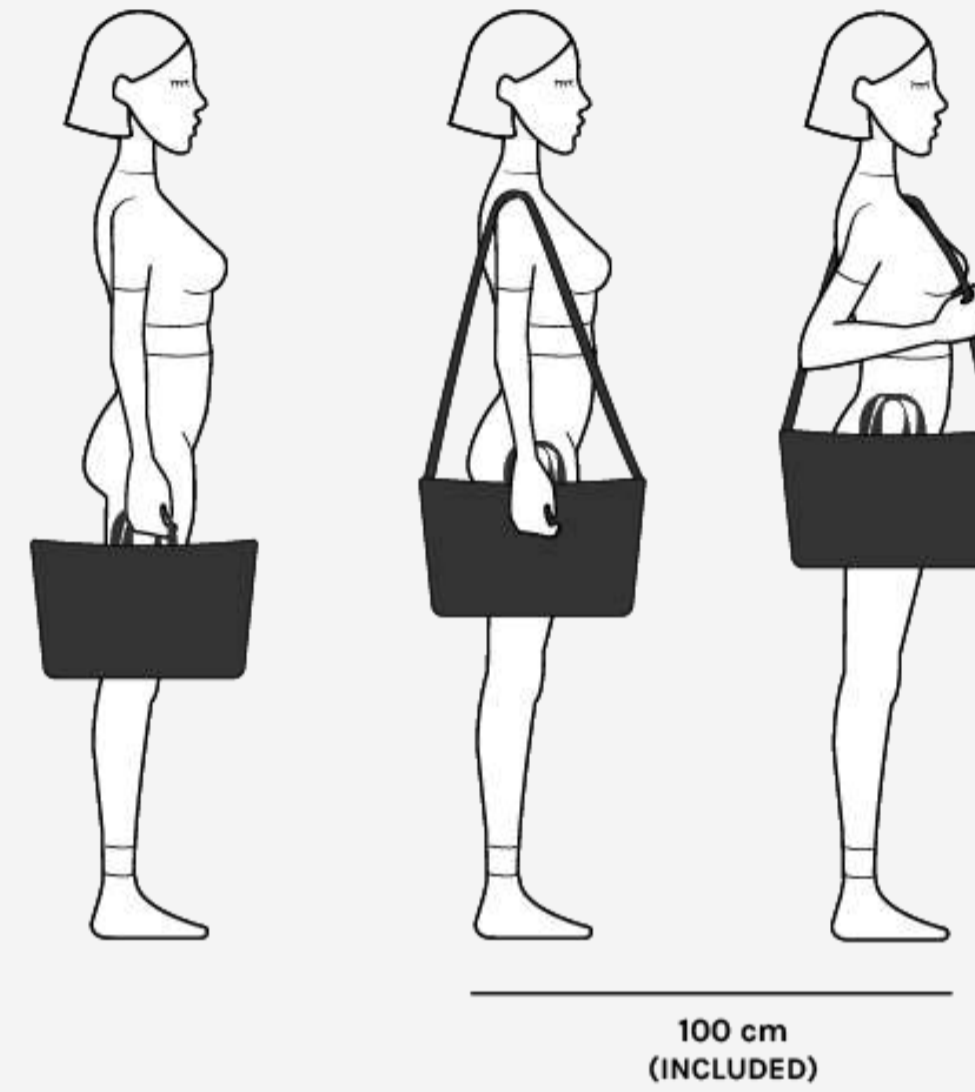

VEGAN

JUANA

SHOP

RETAIL PRICE: 289,95€

*Sign in to your account to see your wholesale price



VEGAN

FERNANDITA

It's useful and comfy like no other one, and it's also very pleasing, soft, resistant and versatile. And the best part is that it keeps the pure and minimal design typical of Labienhecha.

DISCOVER

VEGAN

FERNANDITA

- Flap with double magnetic fastener
- Outside made of vegan Biomaterial 100% silicone and plastic-free
- Inside made of very soft organic cotton canvas with GOT certificate
- Waterproof, very resistant to scratches and stains, hypoallergenic, odorless...
- Belt included
- Reinforced base to keep its shape
- Inside compartments for a great organization (central compartment with zip fastener)

SHOP

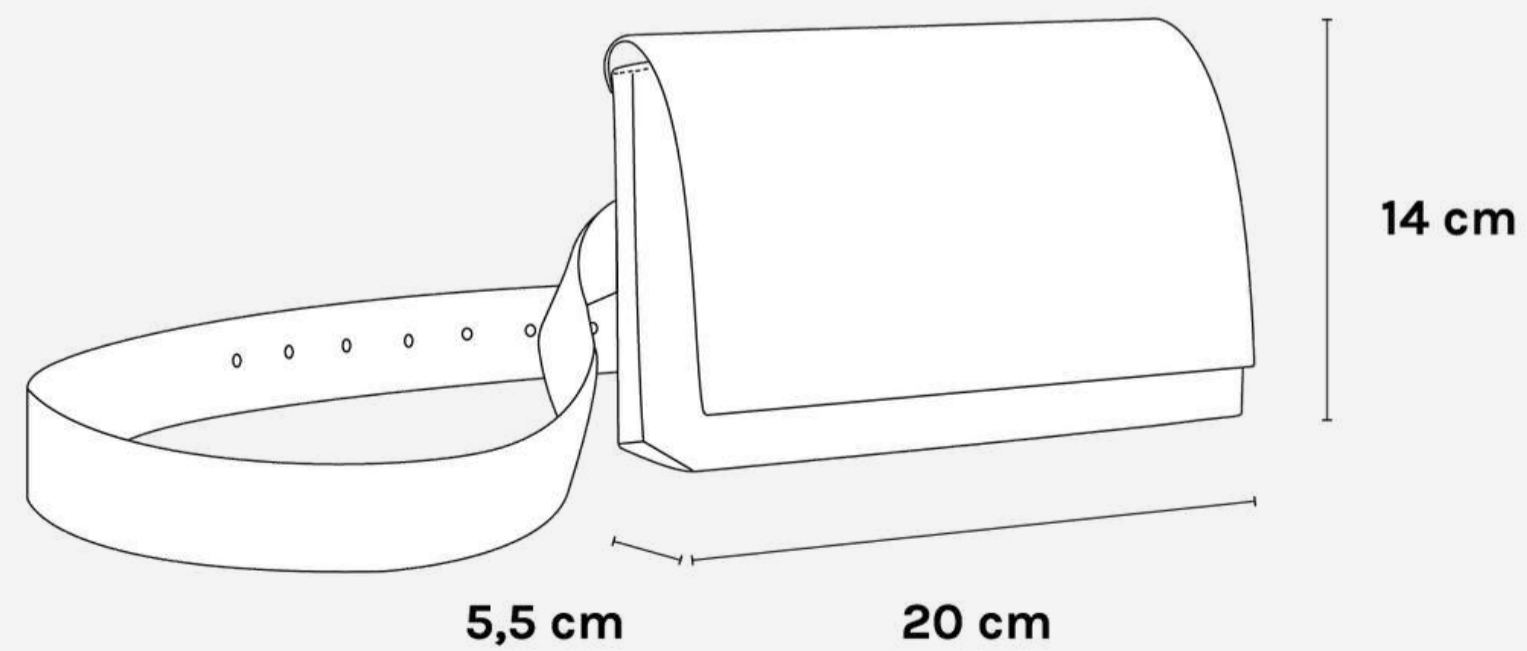

BLACK



OLIVE GREEN



YELLOW



SKY BLUE



LEMON CREAM



BRICK RED



FANCY GREY



MAROON



STONE GREY



MOSS BLUE



POSITIONS | * The model is 1.70 m tall

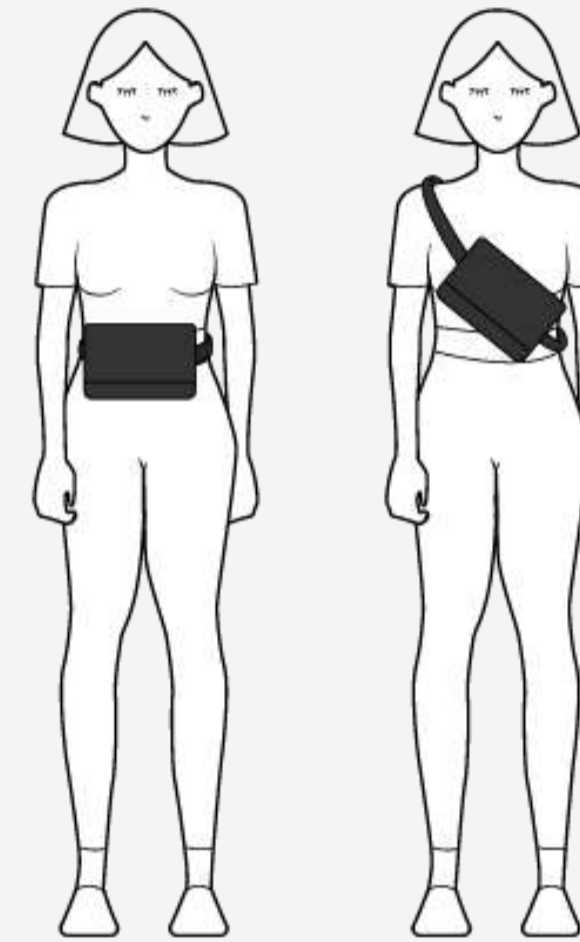

140 cm
(INCLUDED)

VEGAN

FERNANDITA

SHOP

RETAIL PRICE: 219,95€

*Sign in to your account to see your wholesale price

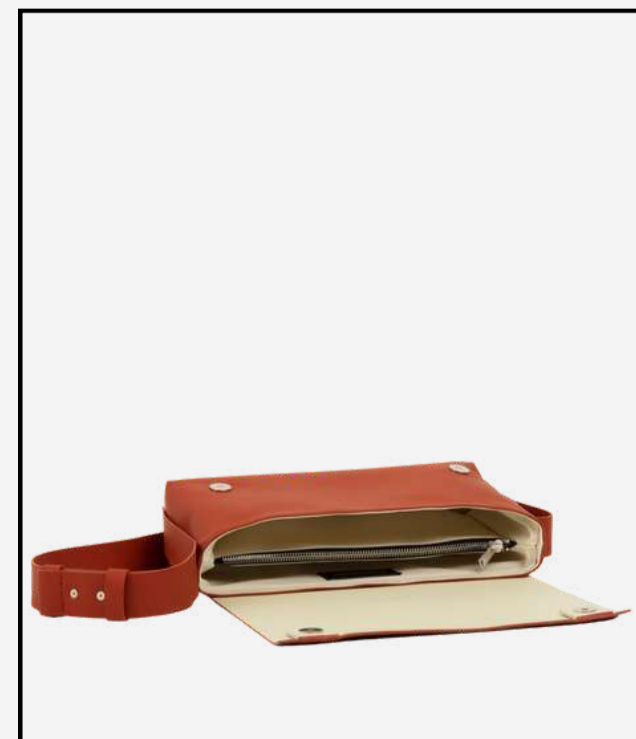
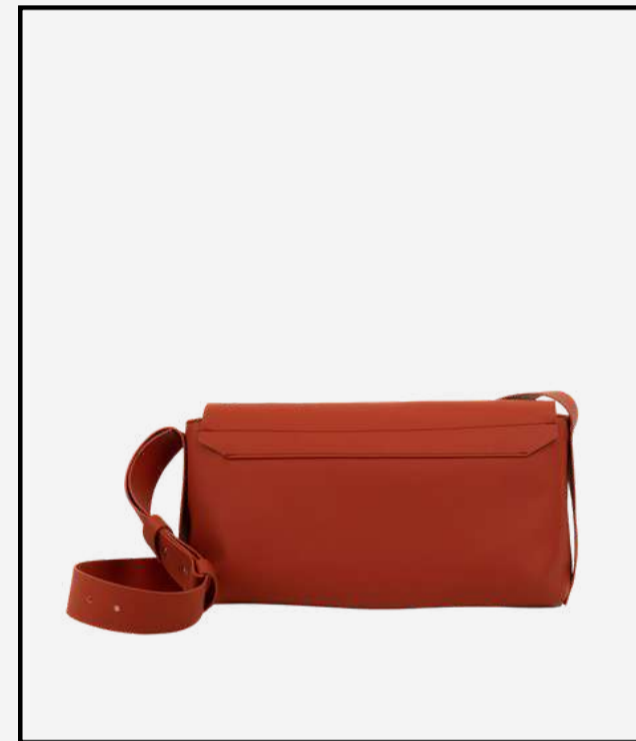
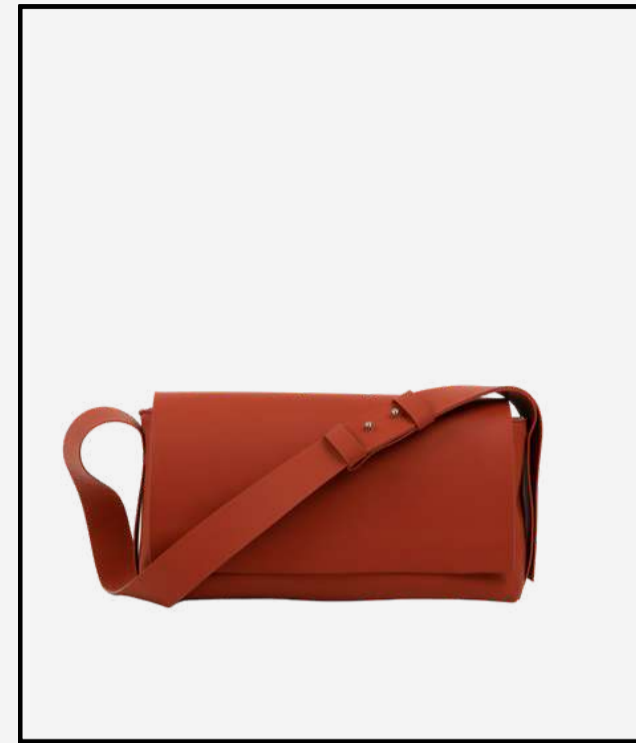
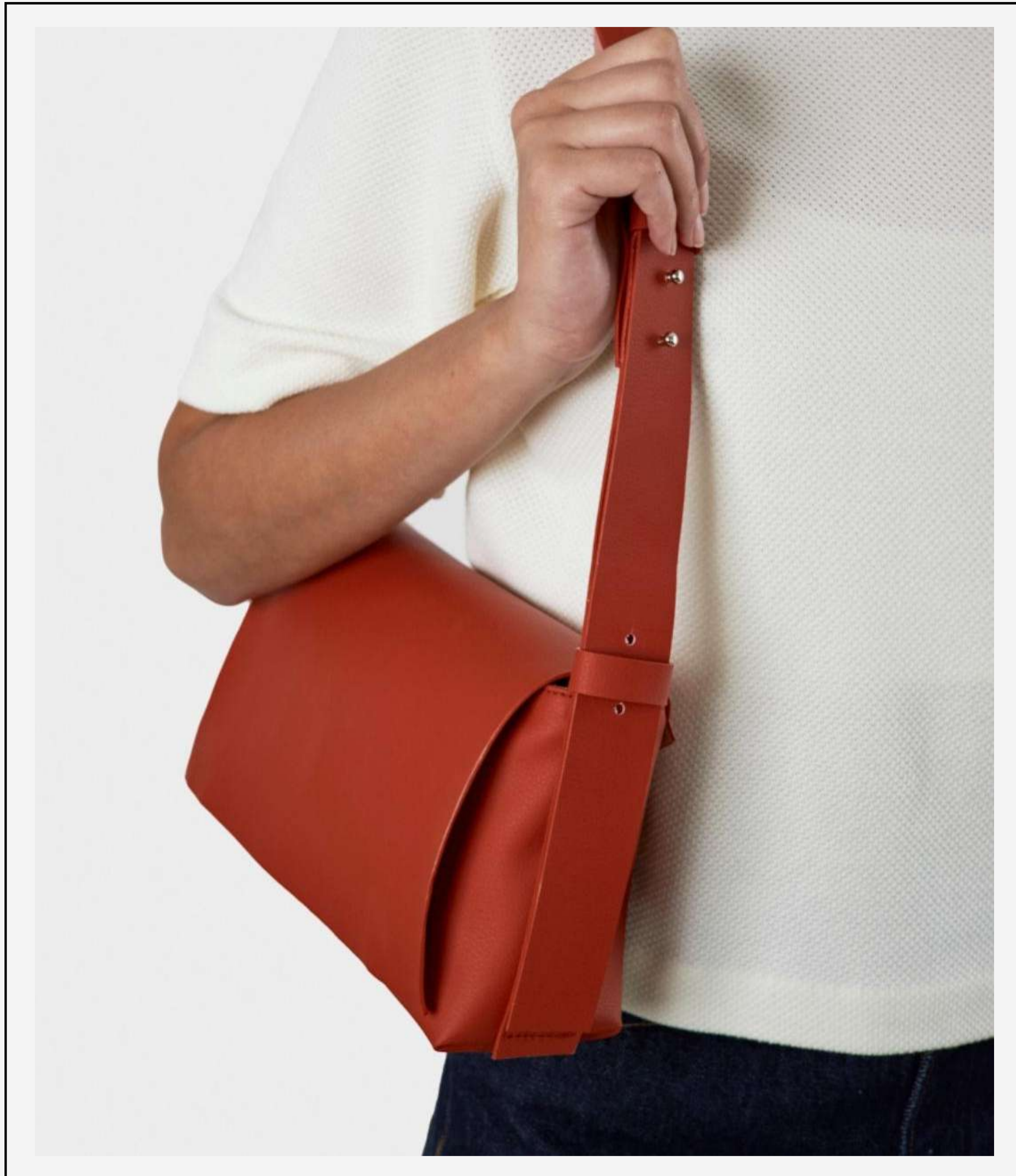

VEGAN

FERNANDA

A baguette bag with flap and magnet closures. Like all our soft bags, the interior is lined with organic cotton and has many compartments - the perfect wardrobe essential!

DISCOVER

VEGAN

FERNANDA

- Flap with double magnetic fastener
- Outside made of vegan Biomaterial 100% silicone and plastic-free
- Inside made of very soft organic cotton canvas with GOT certificate
- Waterproof, very resistant to scratches and stains, hypoallergenic, odorless...
- Adjustable strap
- Reinforced base to keep its shape
- Inside compartments for a great organization (central compartment with zip fastener)

SHOP

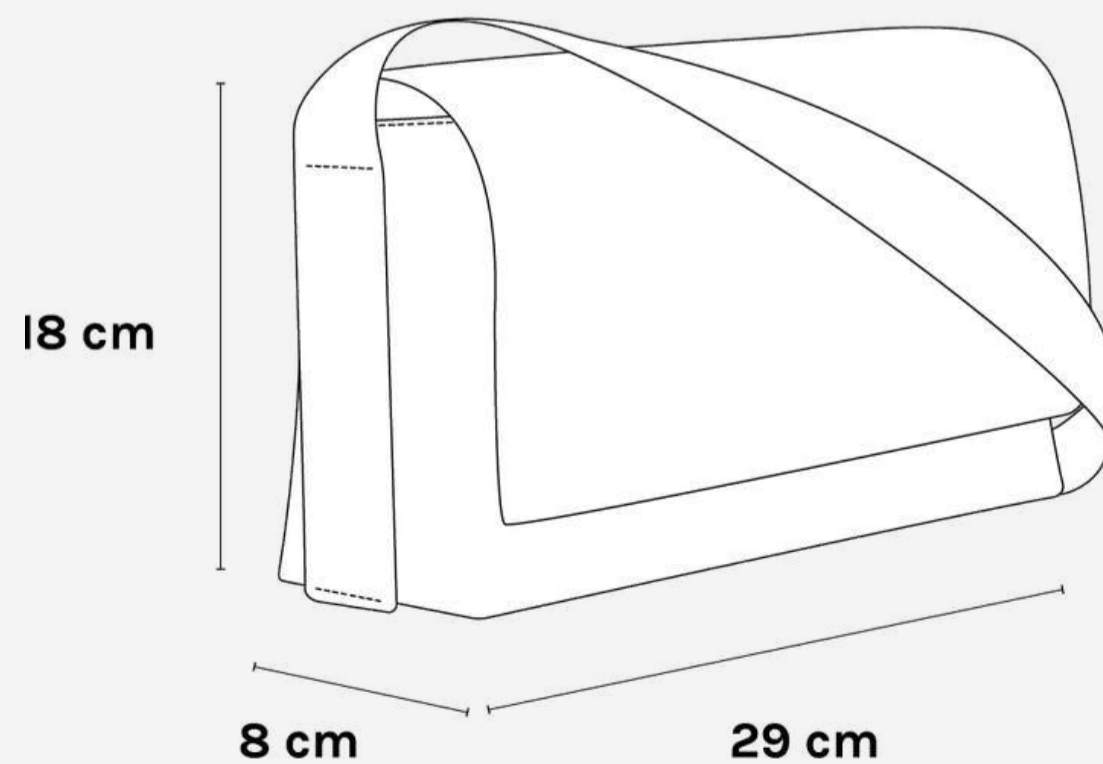

BLACK



OLIVE GREEN



YELLOW



SKY BLUE



LEMON CREAM

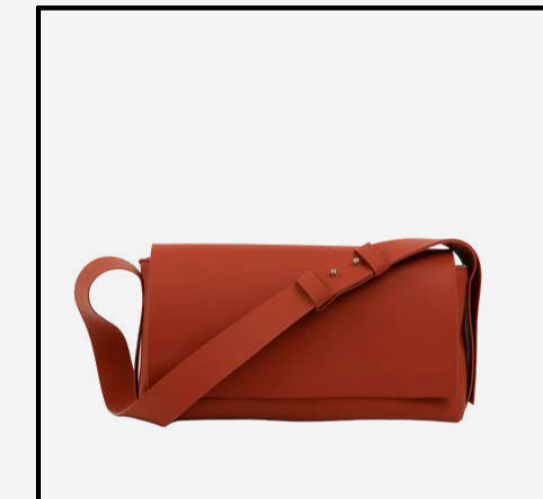

BRICK RED



FANCY GREY



MAROON



STONE GREY



MOSS BLUE



POSITIONS | * The model is 1.70 m tall

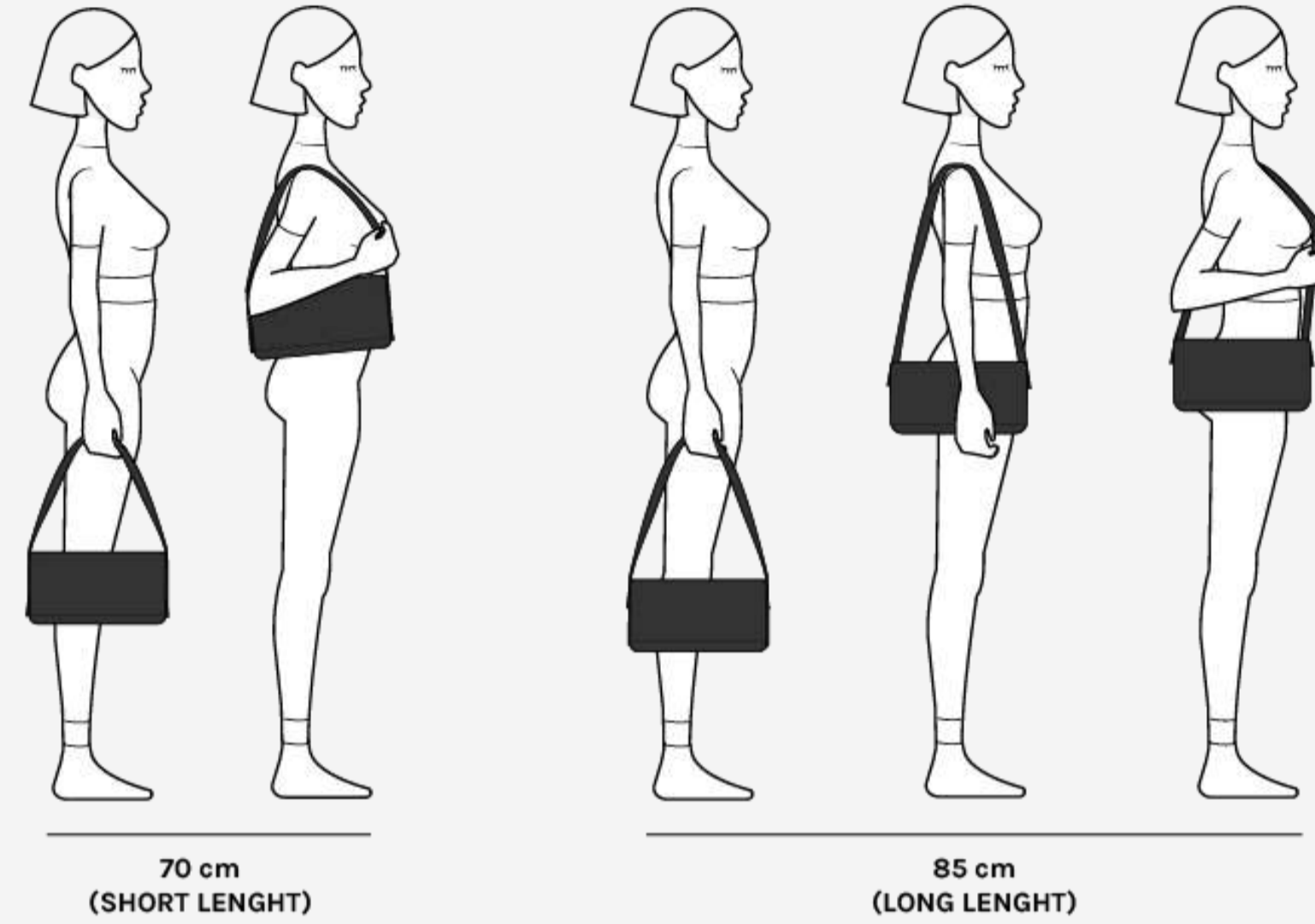

VEGAN

FERNANDA

SHOP

RETAIL PRICE: 269,95€

*Sign in to your account to see your wholesale price

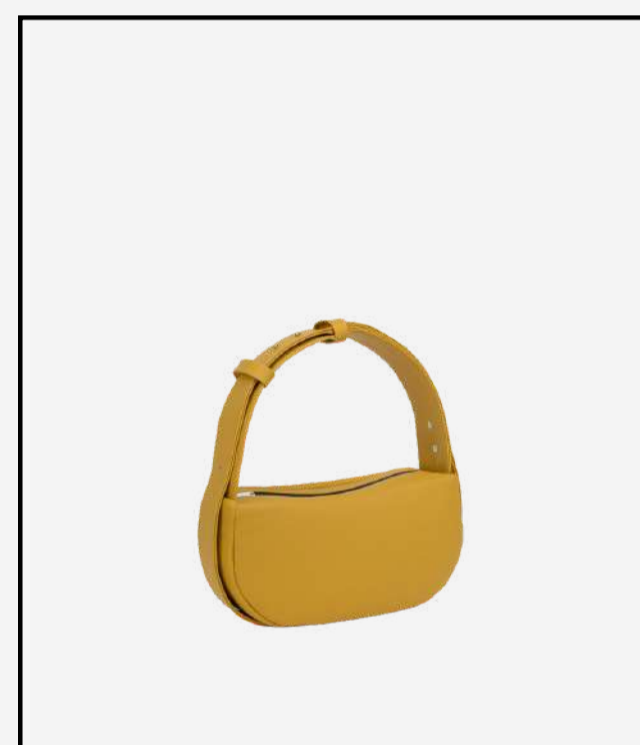

NEW!

ADELITA

Adelita is a versatile and comfortable bag thanks to its multi-position. 5 bags in 1! Adjustable handle with 5 positions. Small but with lots of capacity and extra light.

DISCOVER

NEW!

ADELITA

- Zip fastener YKK
- Outside made of vegan Biomaterial 100% silicone and plastic-free
- Inside made of very soft organic cotton canvas with GOT certificate
- Waterproof, very resistant to scratches and stains, hypoallergenic, odorless...
- Adjustable strap (5 positions). Strap length: Short position 41 cm - Long position 125 cm
- Interior pocket
- Measurements: (Width) 24 cm x (Height) 13 cm x (Depth) 7 cm

SHOP

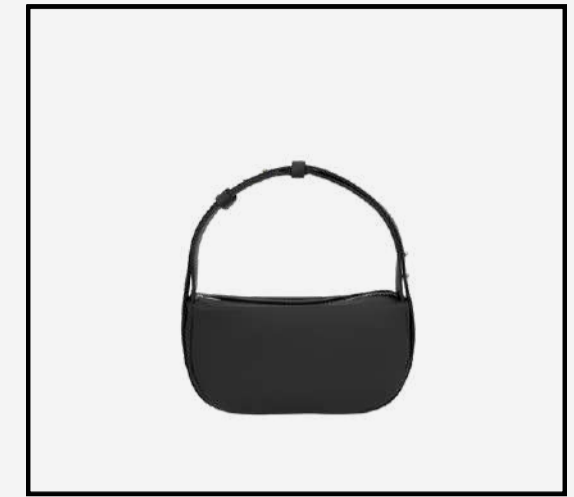

BLACK



OLIVE GREEN



YELLOW



SKY BLUE



LEMON CREAM



BRICK RED

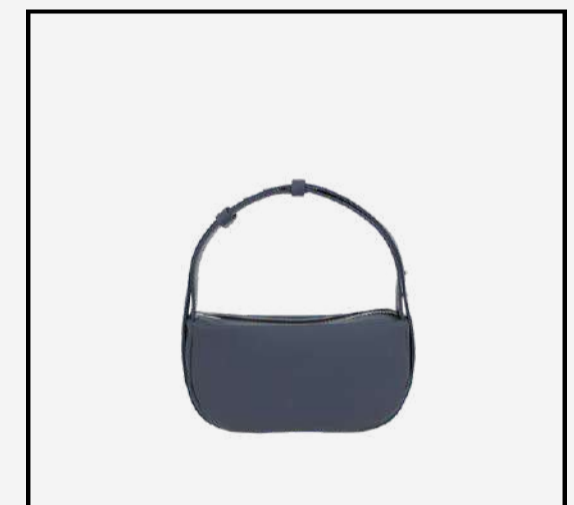

FANCY GREY



MAROON



STONE GREY



MOSS BLUE



POSITIONS | * The model is 1.70 m tall

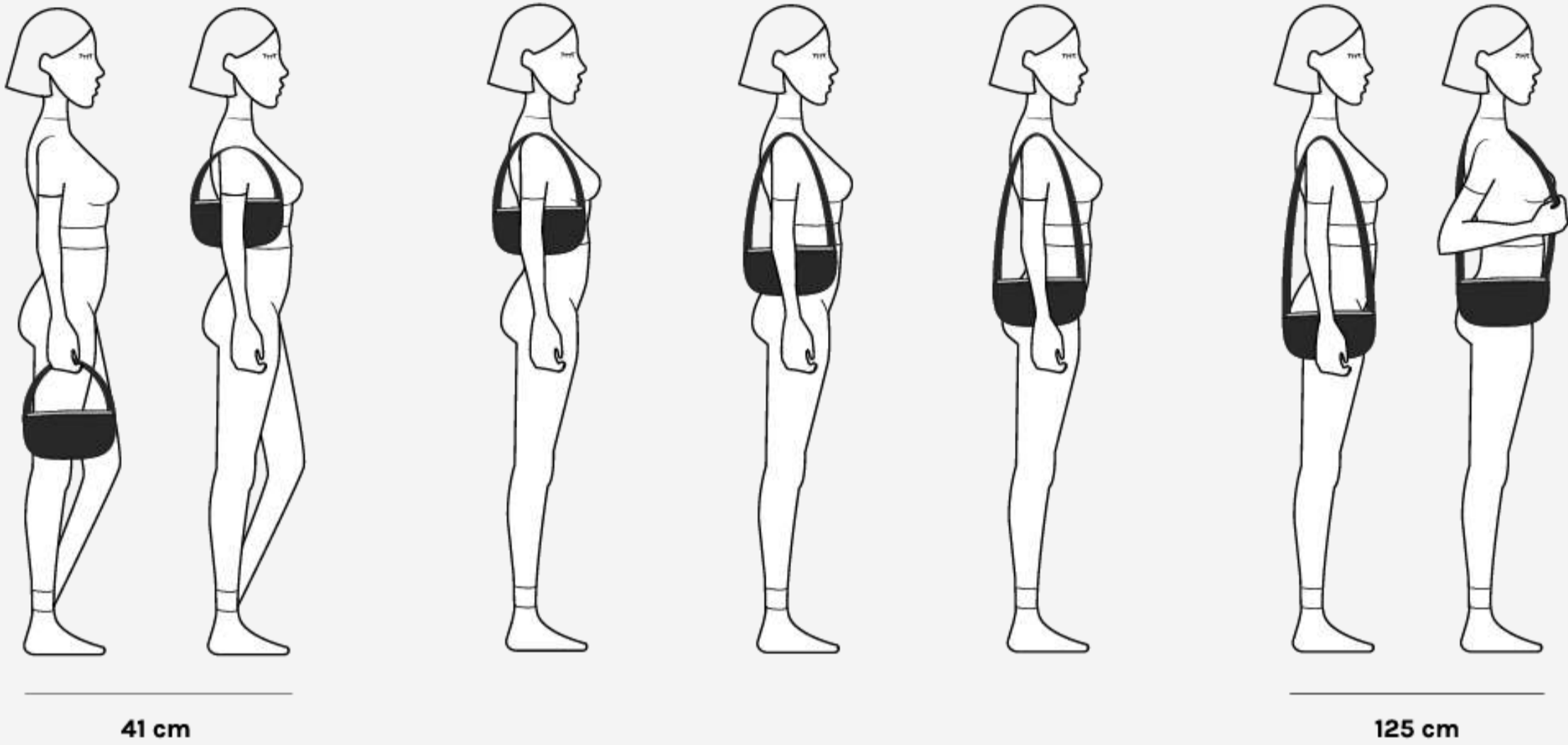

NEW!

ADELITA

SHOP

RETAIL PRICE: 249,95€

*Sign in to your account to see your wholesale price

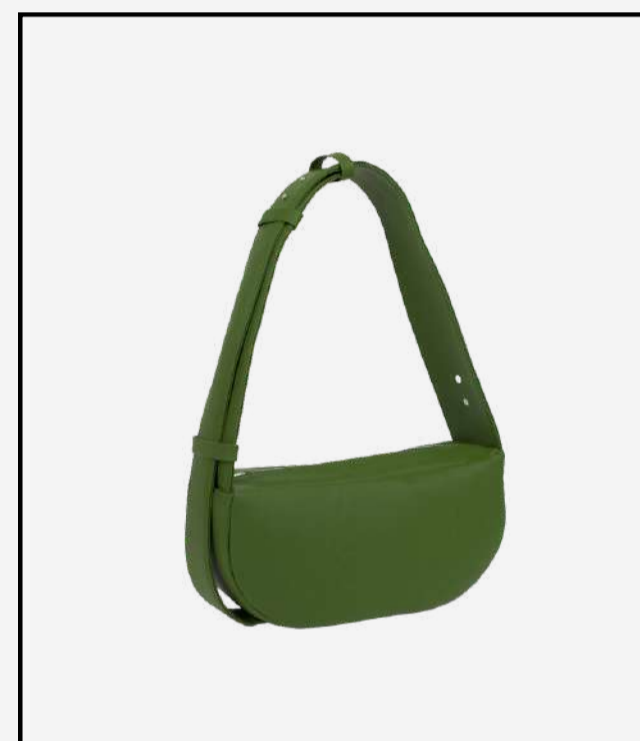

NEW!

ADELINA

It's like having 3 or 4 bags in 1! It has an Adjustable strap with 4 positions. It has an amazing capacity. Super functional, very light.

DISCOVER

NEW!

ADELINA

- Zip fastener YKK
- Outside made of vegan Biomaterial 100% silicone and plastic-free
- Inside made of very soft organic cotton canvas with GOT certificate
- Waterproof, very resistant to scratches and stains, hypoallergenic, odorless...
- Adjustable strap (5 positions). Largo del asa: Short position 68 cm - Long position 150 cm
- Interior pocket
- Measurements: (Width) 30 cm x (Height) 15 cm x (Depth) 9 cm

SHOP



BLACK



OLIVE GREEN



YELLOW



SKY BLUE



LEMON CREAM



BRICK RED

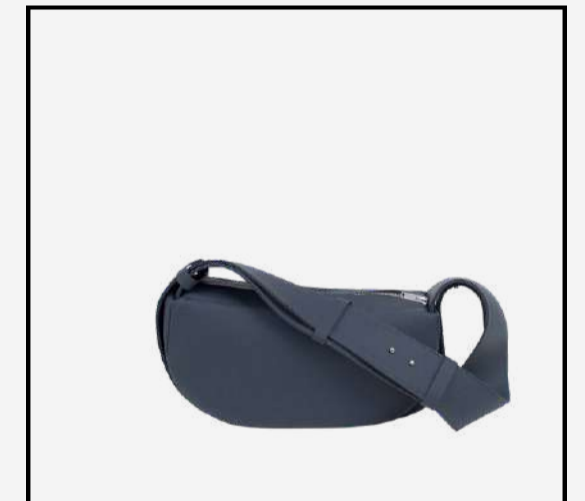

FANCY GREY



MAROON

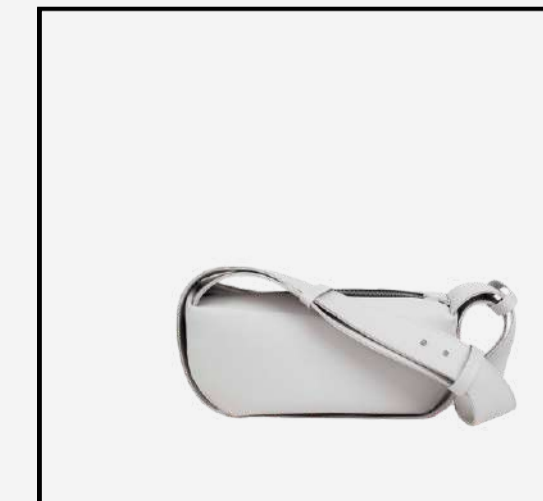

STONE GREY



MOSS BLUE



POSITIONS | * The model is 1.70 m tall

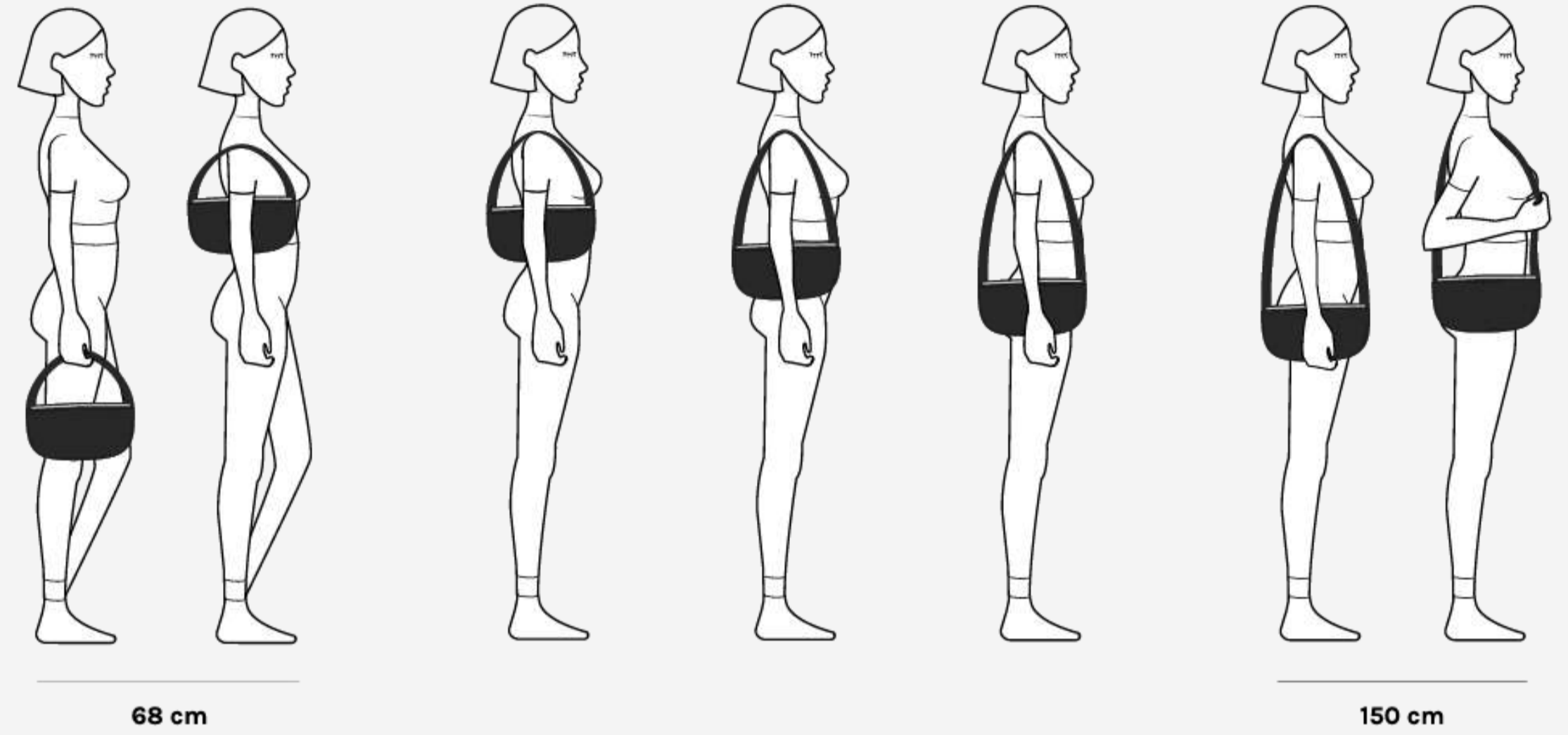

NEW!

ADELINA

SHOP

RETAIL PRICE: 279,95€

*Sign in to your account to see your wholesale price

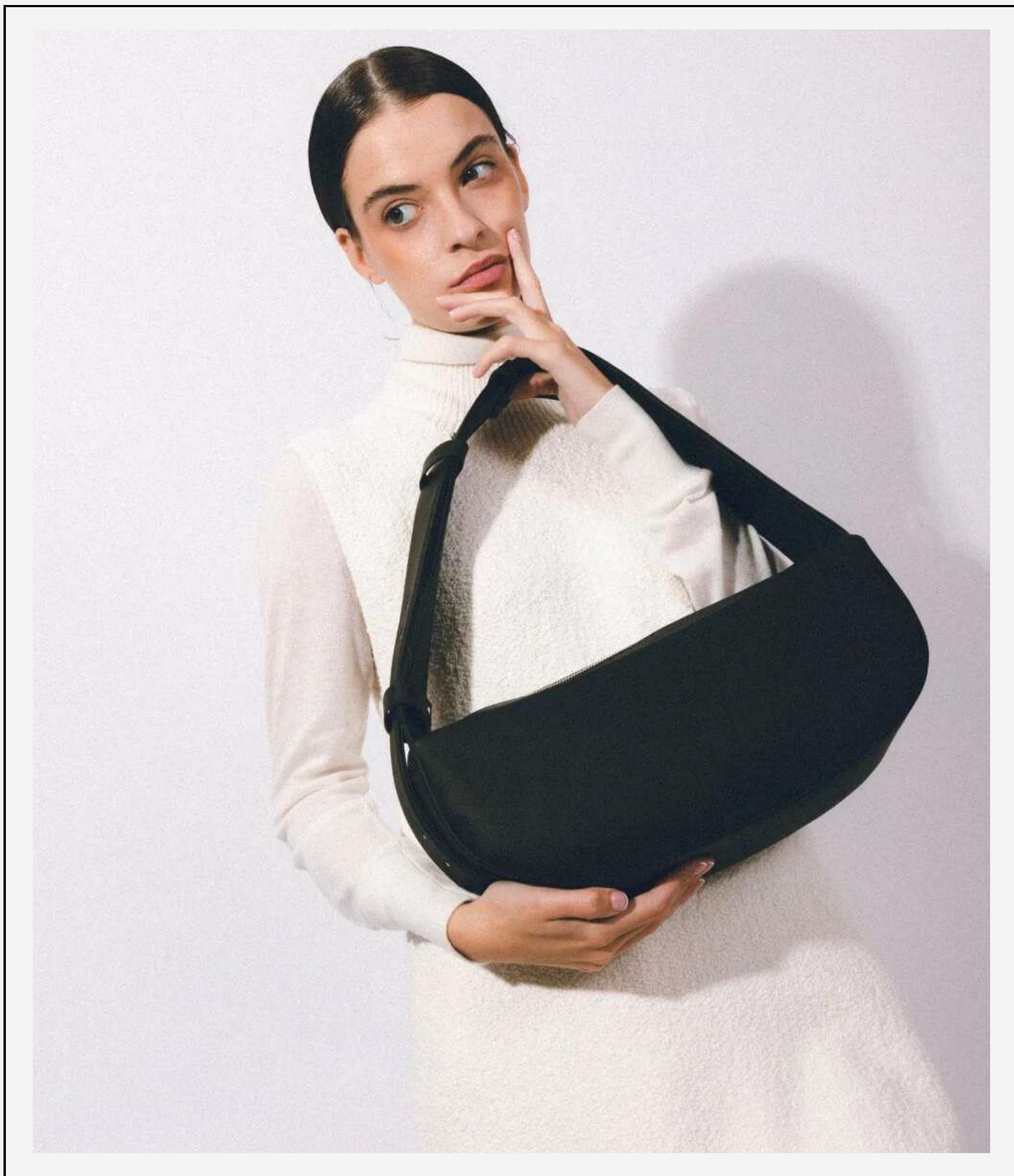

NEW!

ADELA

Multi-position maxi bag - it's like having 3 or 4 bags in 1! It has an Adjustable strap with 4 positions. The most capacious bag in this family of three. Fits everything!

DISCOVER

NEW!

ADELA

- Zip fastener YKK
- Outside made of vegan Biomaterial 100% silicone and plastic-free
- Inside made of very soft organic cotton canvas with GOT certificate
- Waterproof, very resistant to scratches and stains, hypoallergenic, odorless...
- Adjustable strap (5 posiciones). Strap length: Short position 68 cm - Long position 150 cm
- Interior pocket
- Measurements: (Width) 35 cm x (Height) 15 cm x (Depth) 9 cm

SHOP



BLACK



OLIVE GREEN



YELLOW



SKY BLUE



LEMON CREAM



BRICK RED



FANCY GREY



MAROON



STONE GREY



MOSS BLUE



POSITIONS | * The model is 1.70 m tall

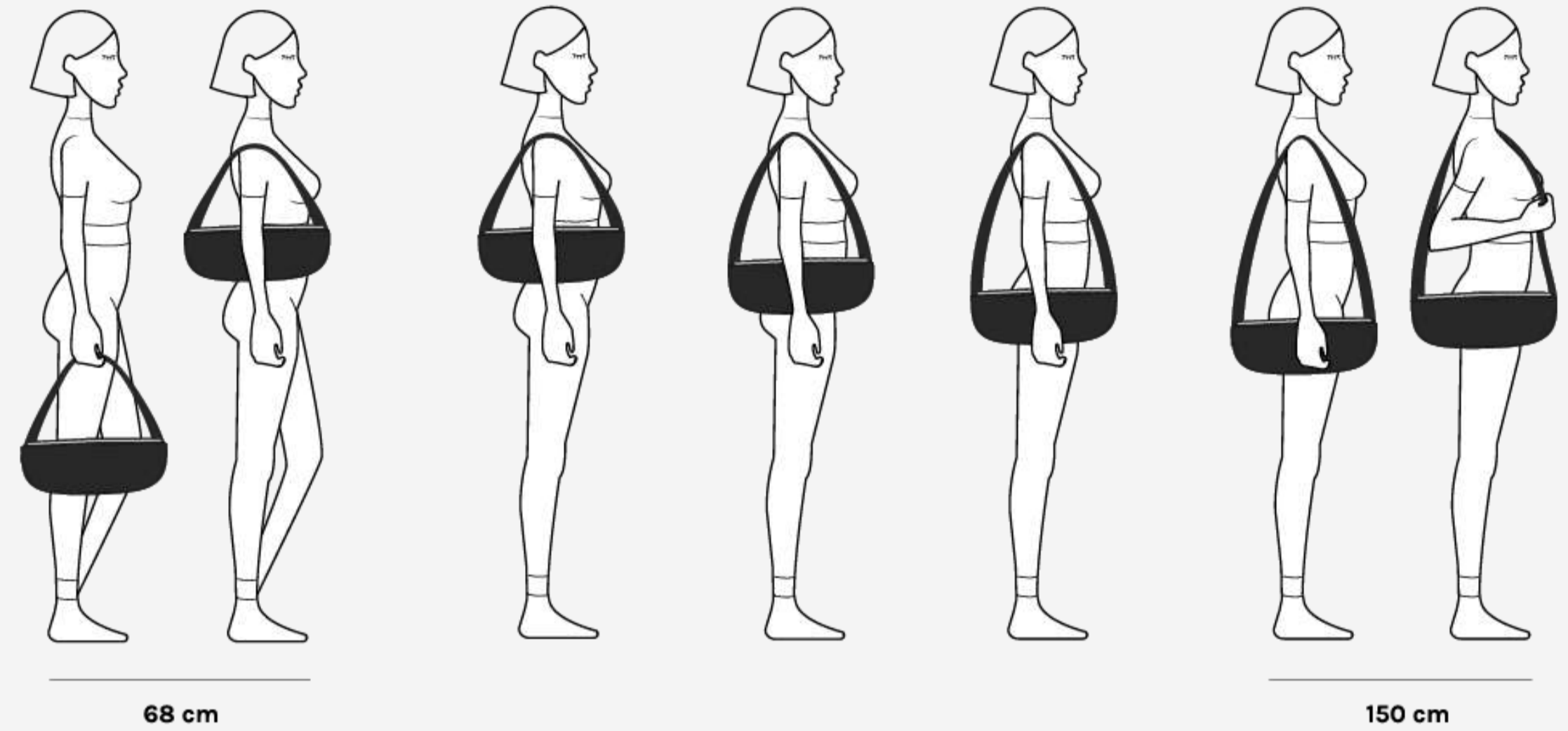

NEW!

ADELA

SHOP

RETAIL PRICE: 289,95€

*Sign in to your account to see your wholesale price



VEGAN

EXTRAS

To spice up our bienhechas. Add straps to interchange and mix colours, and make several bags in one.

DISCOVER

EXTRAS

ÁNGELAS STRAPS

- Available sizes: 60 cm, 70 cm, 80 cm, 100 cm, 120 cm and 140 cm
- Strap with carabiner system. You can add all the extra straps that you want to make matches with your bienhechas bags
- Compatible with Doña Ángela, Ángela, Angelines or Angelita (also if you prefer your Juanas with a thinner strap)
- Width 1,5 cm

SHOP

RETAIL PRICE: 29,95€

*Sign in to your account to see your wholesale price



BLACK



OLIVE GREEN



YELLOW



SKY BLUE



LEMON CREAM



BRICK RED



FANCY GREY



MAROON



STONE GREY



MOSS BLUE

EXTRAS

JUANAS STRAPS

- Available sizes: 60 cm, 70 cm, 80 cm, 100 cm, 120 cm and 140 cm
- Strap with carabiner system. You can add all the extra straps that you want to make matches with your bienhechas bags
- Compatible with Juanita, Juani and Juana (also if you prefer your Ángelas with a thicker strap)
- Width 3 cm

SHOP

RETAIL PRICE: 39,95€

*Sign in to your account to see your wholesale price



BLACK



OLIVE GREEN



YELLOW



SKY BLUE



LEMON CREAM



BRICK RED

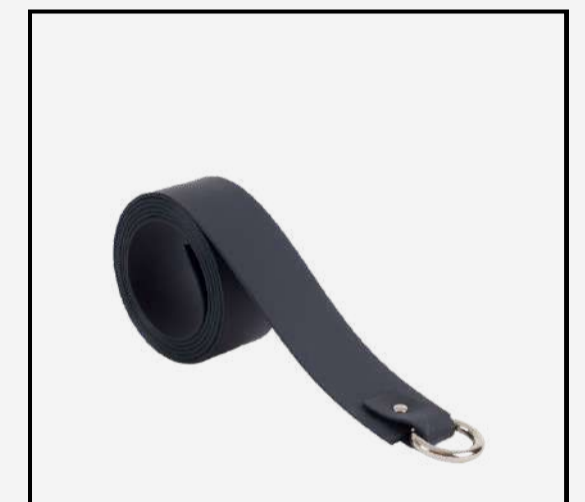

FANCY GREY



MAROON



STONE GREY



MOSS BLUE

TOP 10

BEST-SELLERS

The bienhechas that have been conquering hearts for a long time.

Some of them have been with us since minute one... and we keep on producing them non-stop.

SHOP



PAQUITA DISCOVER →



RAMONA DISCOVER →



PEPE DISCOVER →



SOFÍA (HIJA) DISCOVER →



ANGELINES DISCOVER →



SOFÍA (MADRE) DISCOVER →



ENCARNITA (LM) DISCOVER →



BERNARDITA DISCOVER →



BERNARDA DISCOVER →



JOSEFA DISCOVER →



WHO ARE WE?

ABOUT LABIENHECHA

We are a team of women making (well-made) things in a workshop in Malaga and working along three lines of action: creating a quality, local and ecological product; raising awareness about sustainability and, on the other hand, empowering the female role in entrepreneurship and in life in general.

What makes us most proud of our project?

- 100% handmade, local and ecological product.
- Made in Spain, in our workshop, in a responsible and ethical way.
- Top quality sustainable materials, always certified
- We empower female entrepreneurship



HOW DO WE DO IT?

OUR WORKSHOP DISCOVER

Everything we make is produced in our own workshop, with our own hands - in an artisan and honest way - trying to damage our environment as little as possible, striving to keep tradition alive and, of course, with tons and tons of love.

At Labienhecha we take care of everything. When we say everything, we mean EVERYTHING. From the idea to the design, the making of the bag, the marketing, the commercialisation, administration... Everything!

HOW DO WE DO IT?

SUSTAINABLE PRODUCTION

We believe that nothing is 100% sustainable, but that with small acts and our decisions as a brand, we can reduce our negative impact and foster a culture around sustainability.

We consider all perspectives on sustainability (economic, environmental and/or social and labour). Therefore, we want to advance in our own R&D, working with other sustainable and certified materials, offering other alternatives, expanding our knowledge, improving our resources to achieve better results, optimising our workshop and always aiming to damage our planet as little as possible.



HOW DO WE DO IT?

OUR MATERIALS

At Labienhecha we strive to research materials that meet our high requirements in terms of sustainability. That is why we only work with eco-friendly, durable, quality materials that are environmentally friendly and have the least negative impact. These are the main materials we work with:



VEGAN BIOMATERIAL



RECYCLED LEATHER



ORGANIC COTTON

HELP

NEW CLIENT REGISTRATION →

CLIENT ACCESS →

B2B SHOPPING PORTAL →

QUICK ORDER →

REQUEST DEMO →

PROMOTIONS →

FAQS →

CLIENT AREA

ORDER FORM



WE DON'T MAKE PERFECT THINGS,
WE JUST MAKE WELL-MADE THINGS

Labienhecha

CONTACTO

C/ Croacia, 19. CP: 29004 - Málaga, España
sales@labienhecha.com

SOCIAL & WEB

FB: Labienhecha
IG: @soylabienhecha
WEB: labienhecha.com

INFO

We design and create bags and other beloved goods using only certified eco-materials. Everything is made on a slow burn in a small workshop in Málaga by a super team of women that love what they do.