

COLECCIÓN CUERO RECICLADO

2024

CATÁLOGO



**Labienhecha**

# ÍNDICE

---

CUERO RECICLADO →

ACCESORIOS →

EXTRAS →

PENDIENTES →

TOP 10 - MÁS VENDIDOS →

SOBRE LABIENHECHA →

NUESTRO TALLER →

ÁREA CLIENTE B2B →

CUENTA CLIENTE

ORDER FORM



LOS DE SIEMPRE

## COLECCIÓN CUERO RECICLADO

El core de nuestra colección. Son los que llevan con nosotras desde el principio y parece que no se nos van. Los iconos de Labienhecha (y los más vendidos). Los producimos con cuero reciclado de proveedor local certificado con Global Recycled Standard y Oeko Tex Leather Standard.

DESCÚBRELA

NO FALLAN

## SÚPER TOP

Los de siempre (y los más vendidos). Llevan en nuestra colección años y se han convertido en auténticos iconos de Labienhecha.

COMPRAR



PAQUITA

DESCÚBRELA →



PACA

DESCÚBRELA →

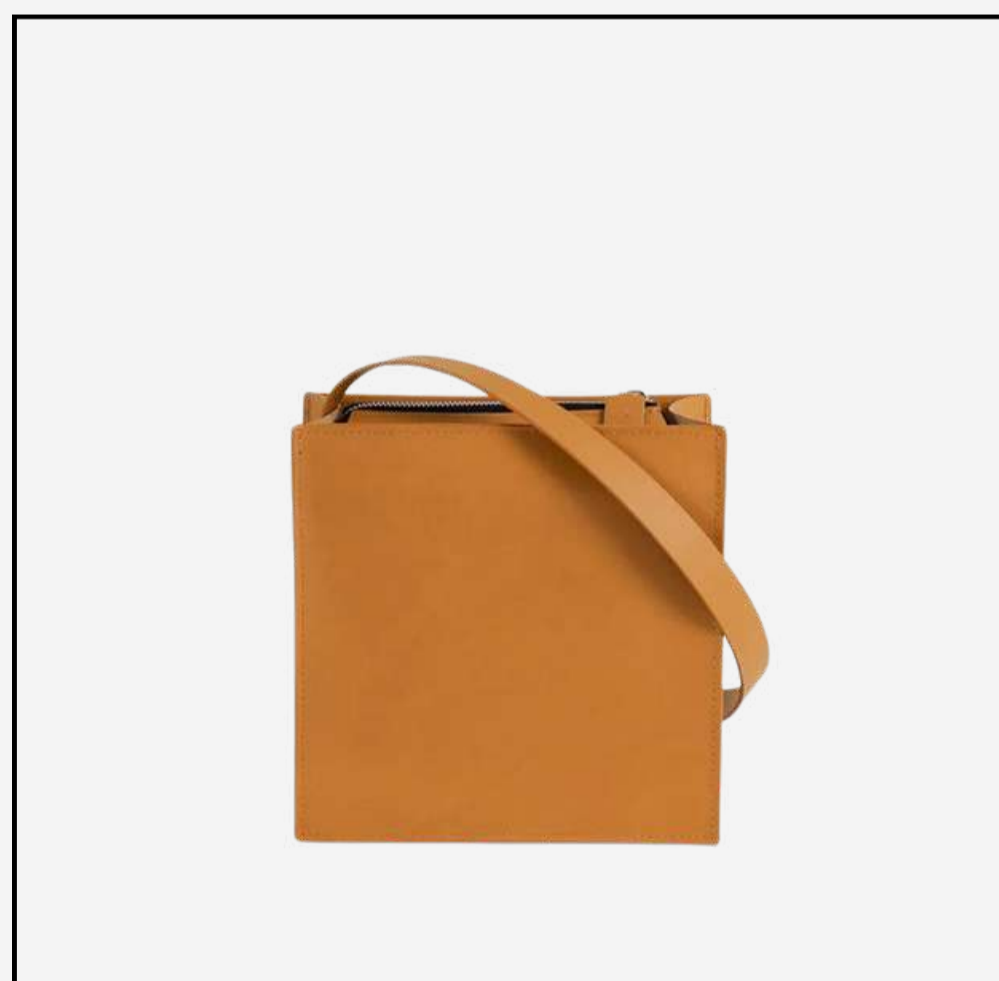

SOFÍA (HIJA)

DESCÚBRELA →



SOFÍA (MADRE)

DESCÚBRELA →



PEPA

DESCÚBRELA →



JOSEFA

DESCÚBRELA →

LOS QUE ENAMORAN

## LOS MÁS DESEADOS

Los más especiales por su forma o su personalidad. Auténticas joyas de la colección que enamoran.

COMPRAR

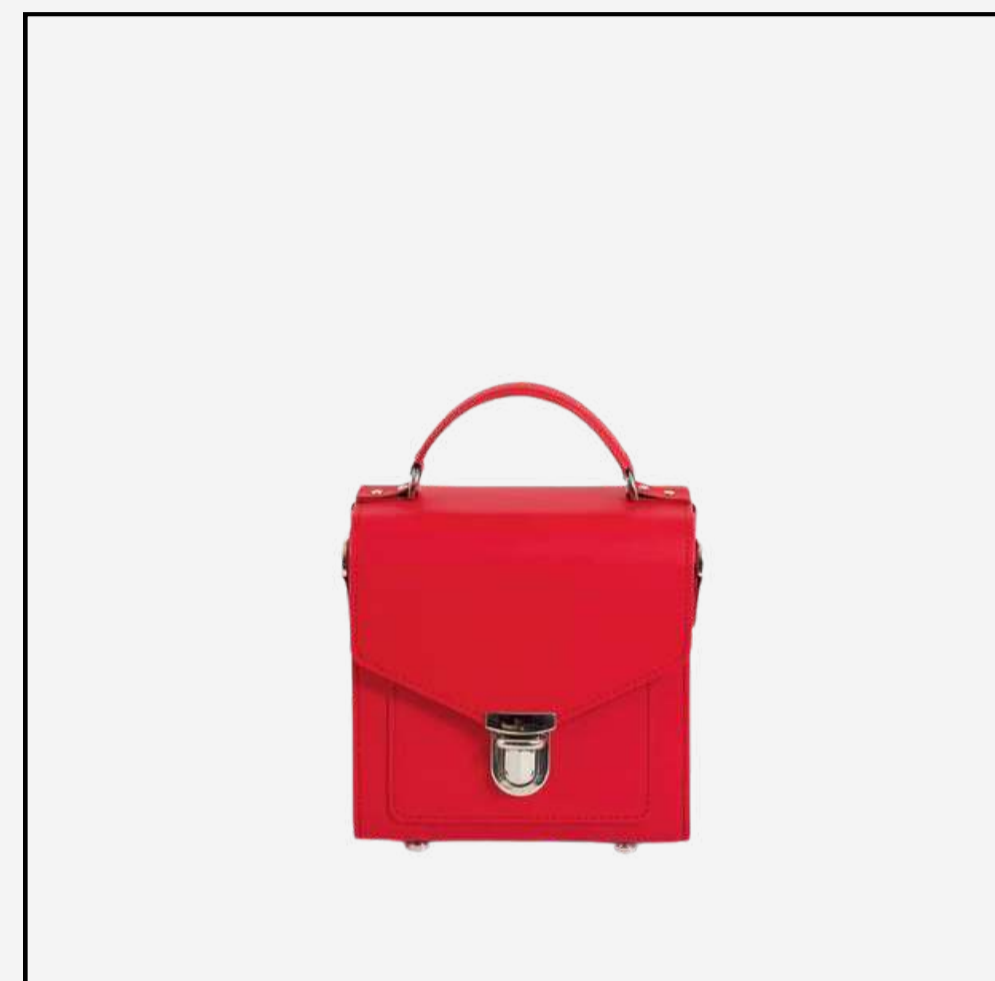

RAMONA

DESCÚBRELA →



LOLA (LA MAYOR)

DESCÚBRELA →



MARCELA

DESCÚBRELA →



BERNARDA

DESCÚBRELA →



MARCELINA

DESCÚBRELA →



BERNARDITA

DESCÚBRELA →

NO FALLAN

## BÁSICOS, NO TAN BÁSICOS

Una colección de bolsos ligeros, muy versátiles y en diferentes tamaños para cubrir necesidades diarias sin renunciar al diseño.

COMPRAR



AMPARITO (LM) [DESCÚBRELA →](#)

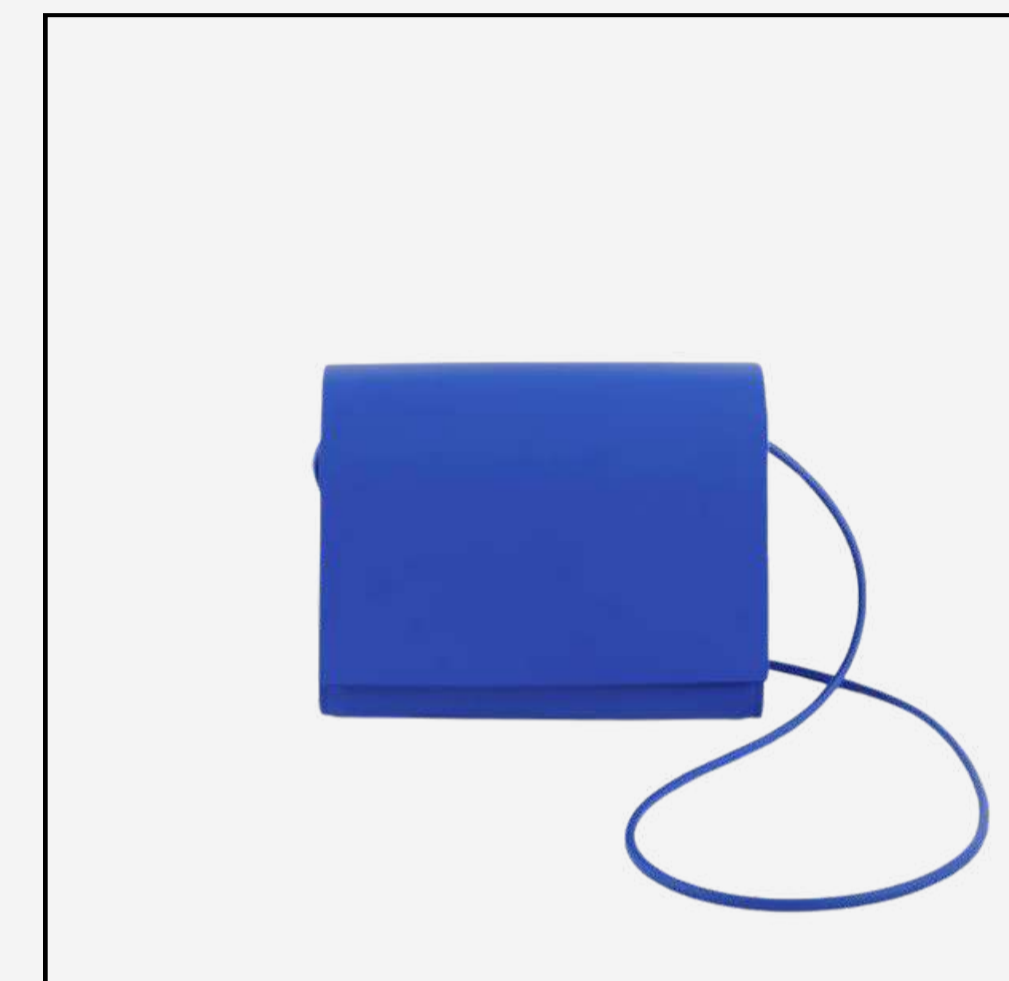

ENCARNITA (LM) [DESCÚBRELA →](#)

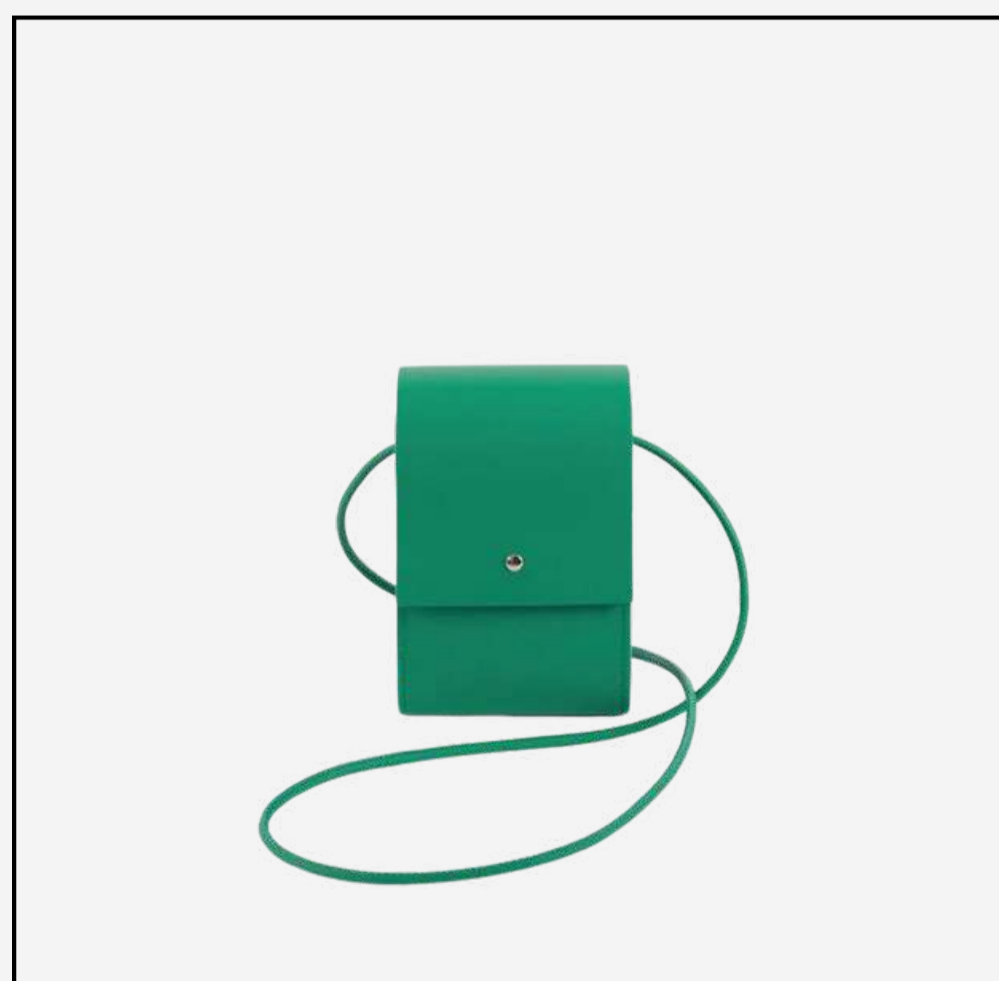

CARMELITA [DESCÚBRELA →](#)

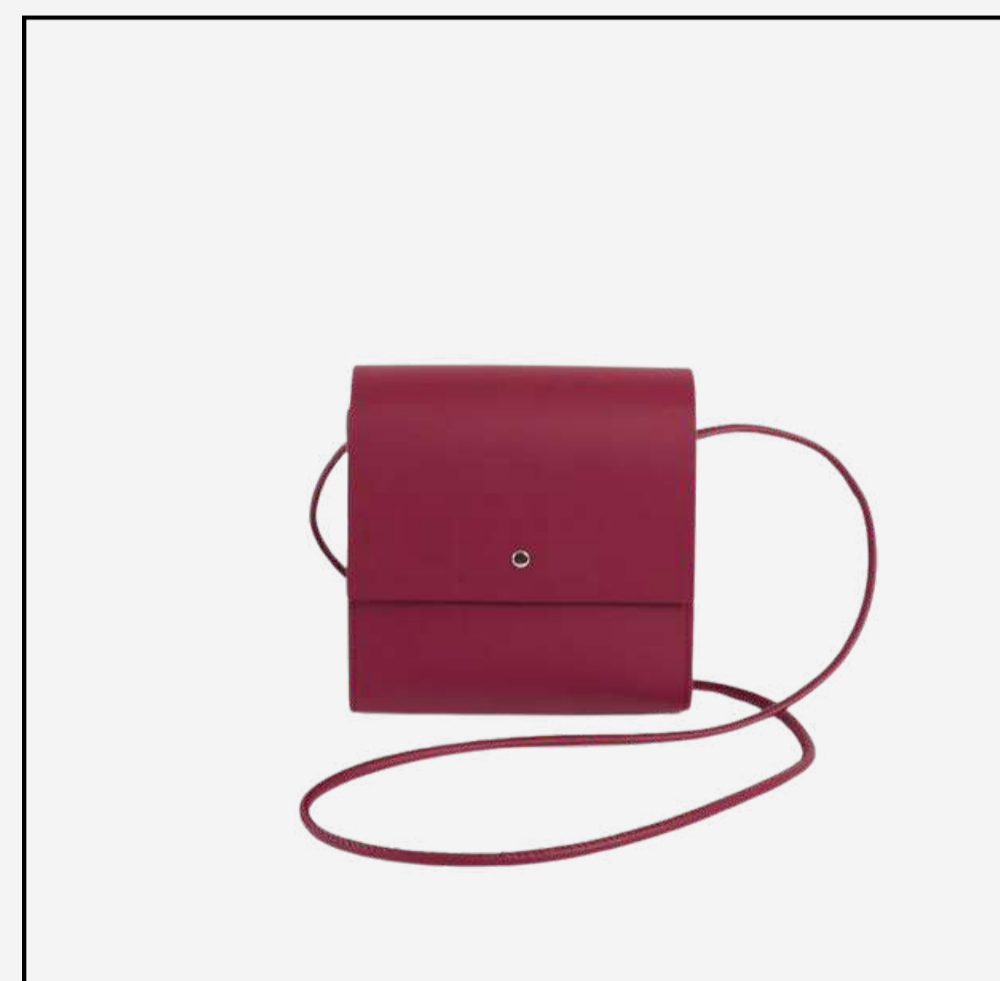

CARMELA [DESCÚBRELA →](#)



CARMEN [DESCÚBRELA →](#)

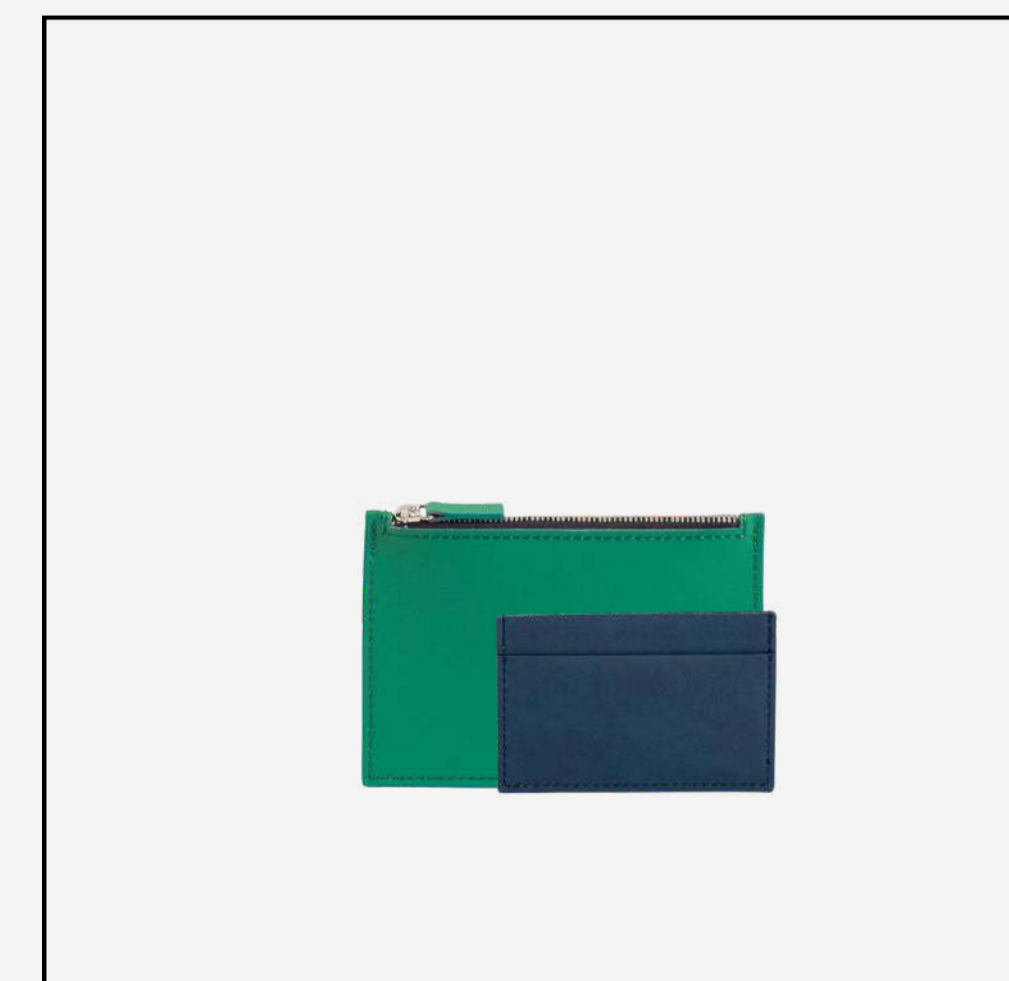

ACCESORIOS [DESCÚBRELOS →](#)

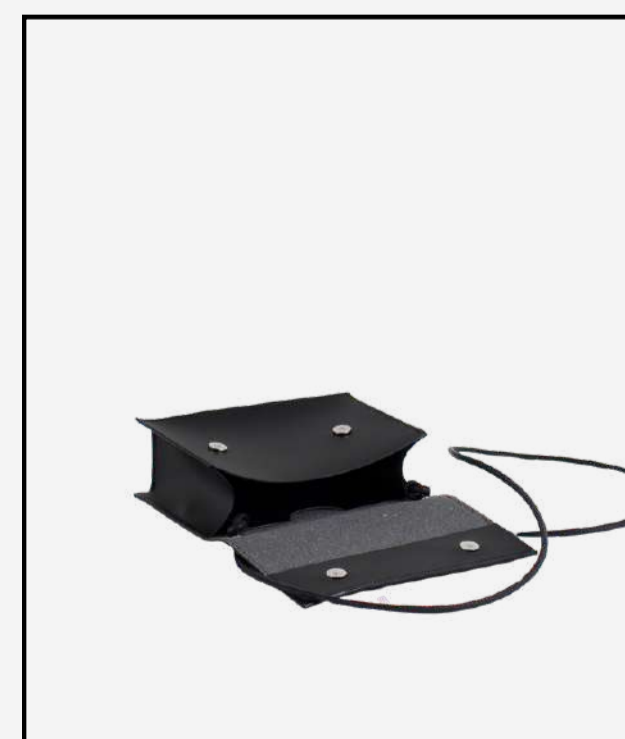

TOP VENTAS - N°1

## PAQUITA

Nuestro más vendido desde hace años. Paquita es irresistible. Un bolso pequeño pero versátil que roba corazones desde el minuto número uno.

DESCÚBRELA

## TOP VENTAS

# PAQUITA

- Cierre de imán (doble)
- Un bolsillo interior
- Cantos lujados y pintados a mano para una mayor protección
- Incluye un cordón ajustable de 140 cm
- Cordones extra disponibles: 50 cm, 100 cm, 120 cm o 140 cm
- Pasahombros a juego

COMPRAR

EXTRAS

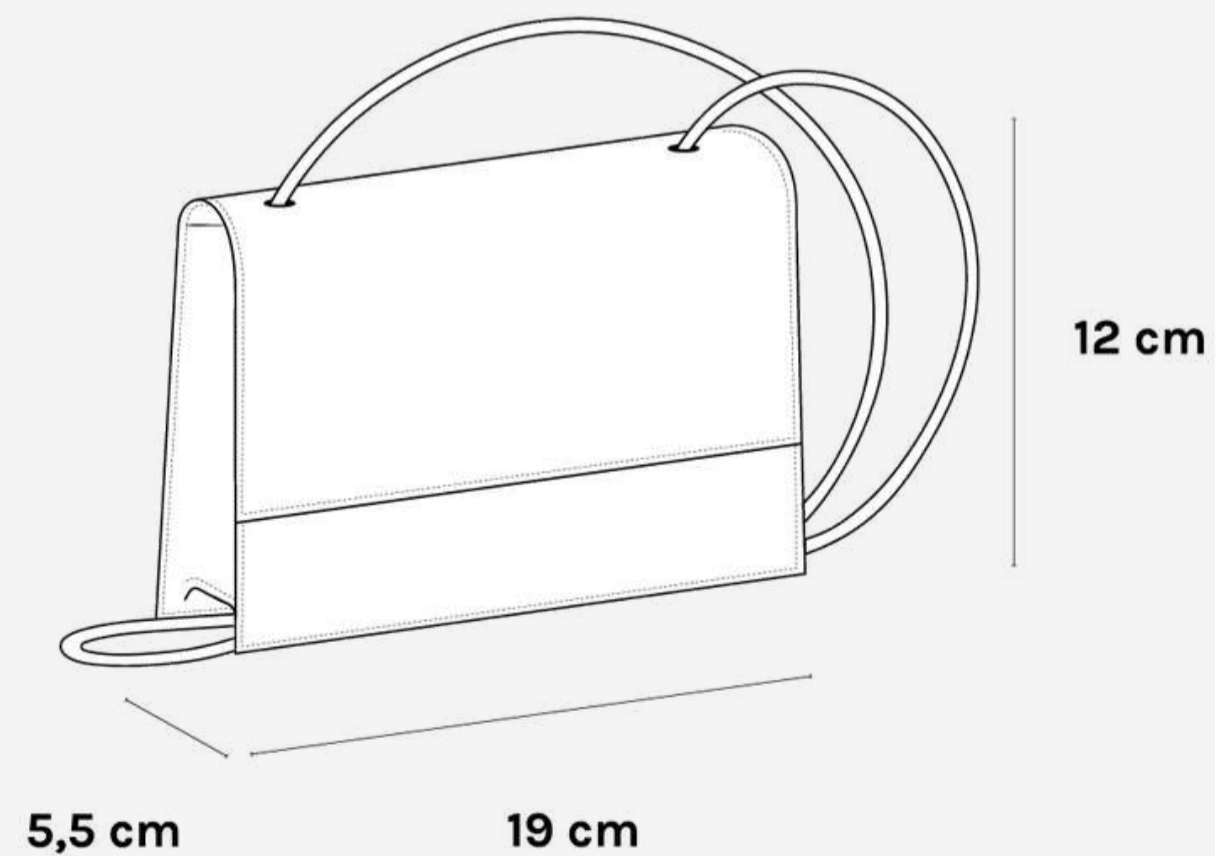

TEJA

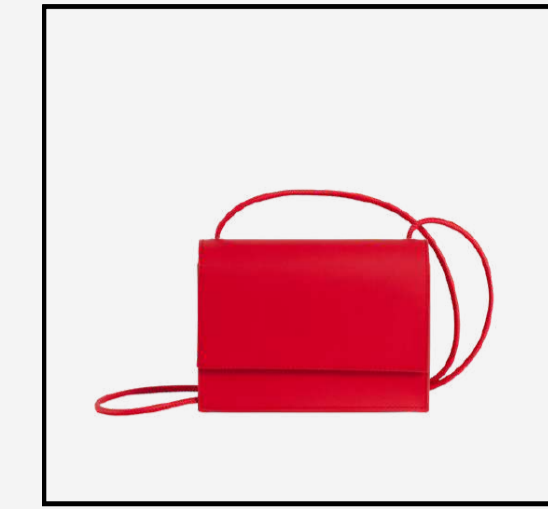

ROJO

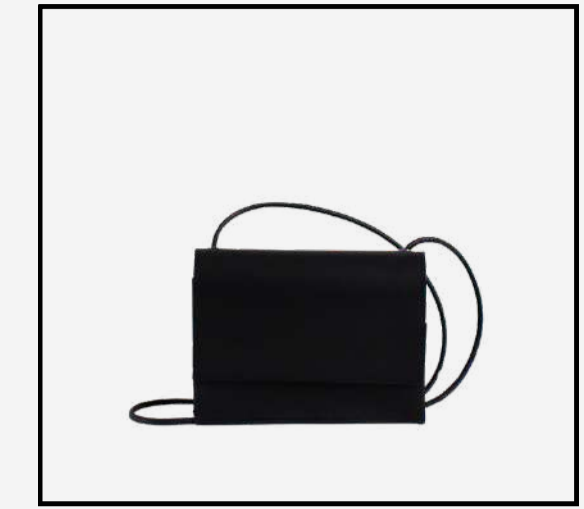

NEGRO BOOM



NUDE



CELESTE



VINO



CRUDO



TOSTADO



NAVY

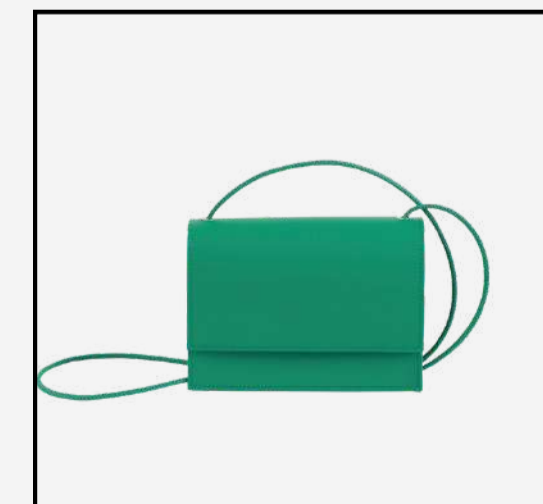

VERDE TRÉBOL

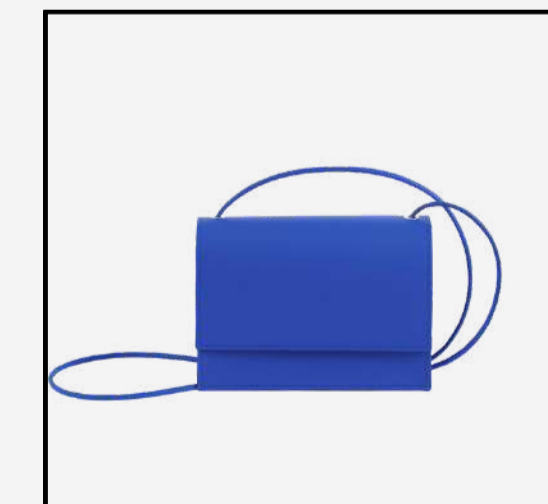

AZUL BIENHECHA

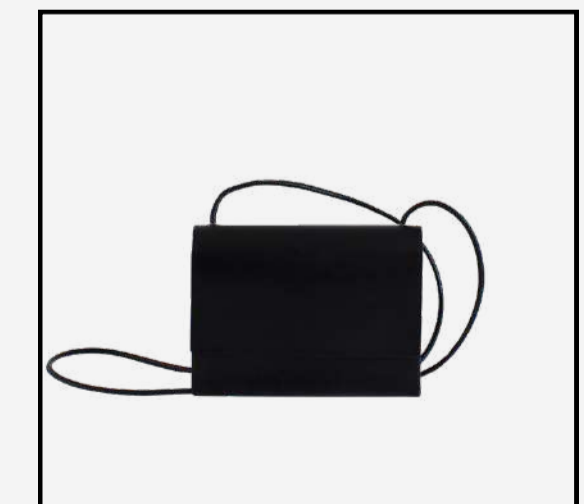

NEGRO MATE





POSICIONES | \*La modelo mide 1,70 m



50 cm

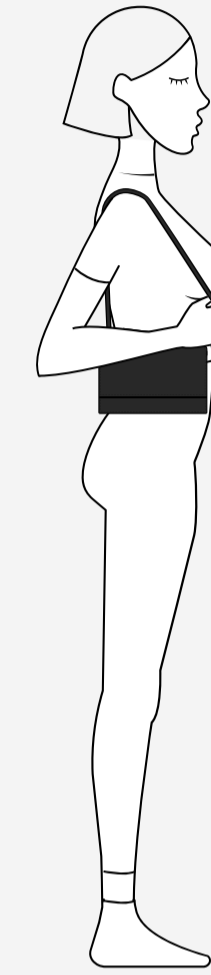

100 cm

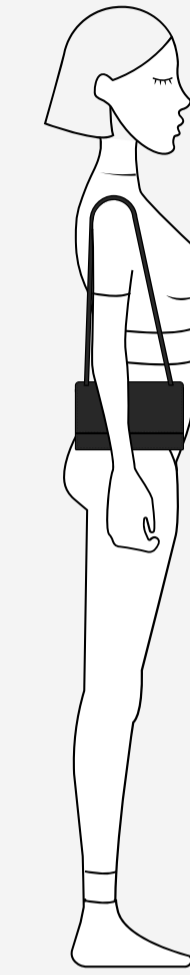

120 cm

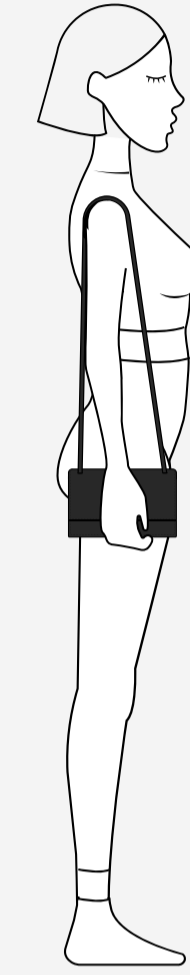

140 cm  
(INCLUIDO)

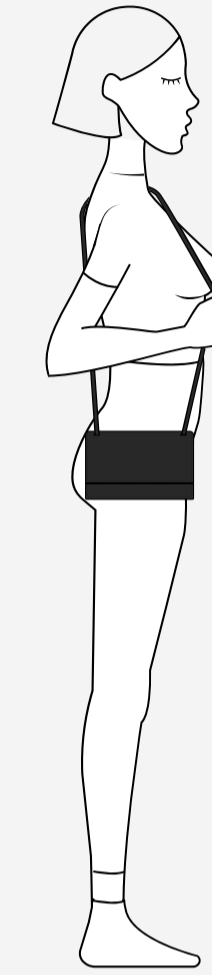

TOP VENTAS

## PAQUITA

COMPRAR

PVP RETAIL: 149,95€

\*Accede a tu cuenta para ver tu precio wholesale

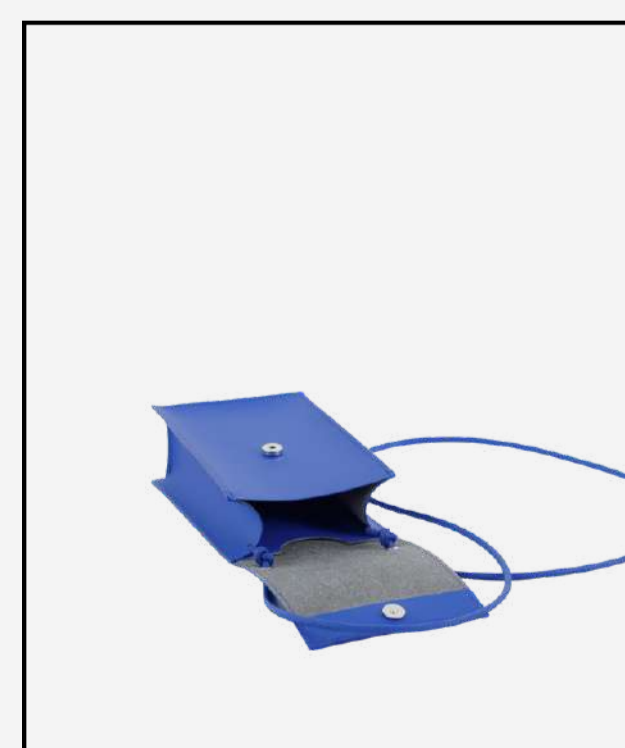

TOP VENTAS

## PACA

Paca es ese bolso superversátil para llevar lo justo y necesario. Se ha convertido en top y en uno de los más unisex de la colección.

DESCÚBRELA

## TOP VENTAS

# PACA

- Cierre de imán
- Un bolsillo interior
- Cantos lujados y pintados a mano para una mayor protección
- Incluye un cordón ajustable de 140 cm
- Cordones extra disponibles: 50 cm, 100 cm, 120 cm o 140 cm
- Pasahombros a juego

COMPRAR

EXTRAS

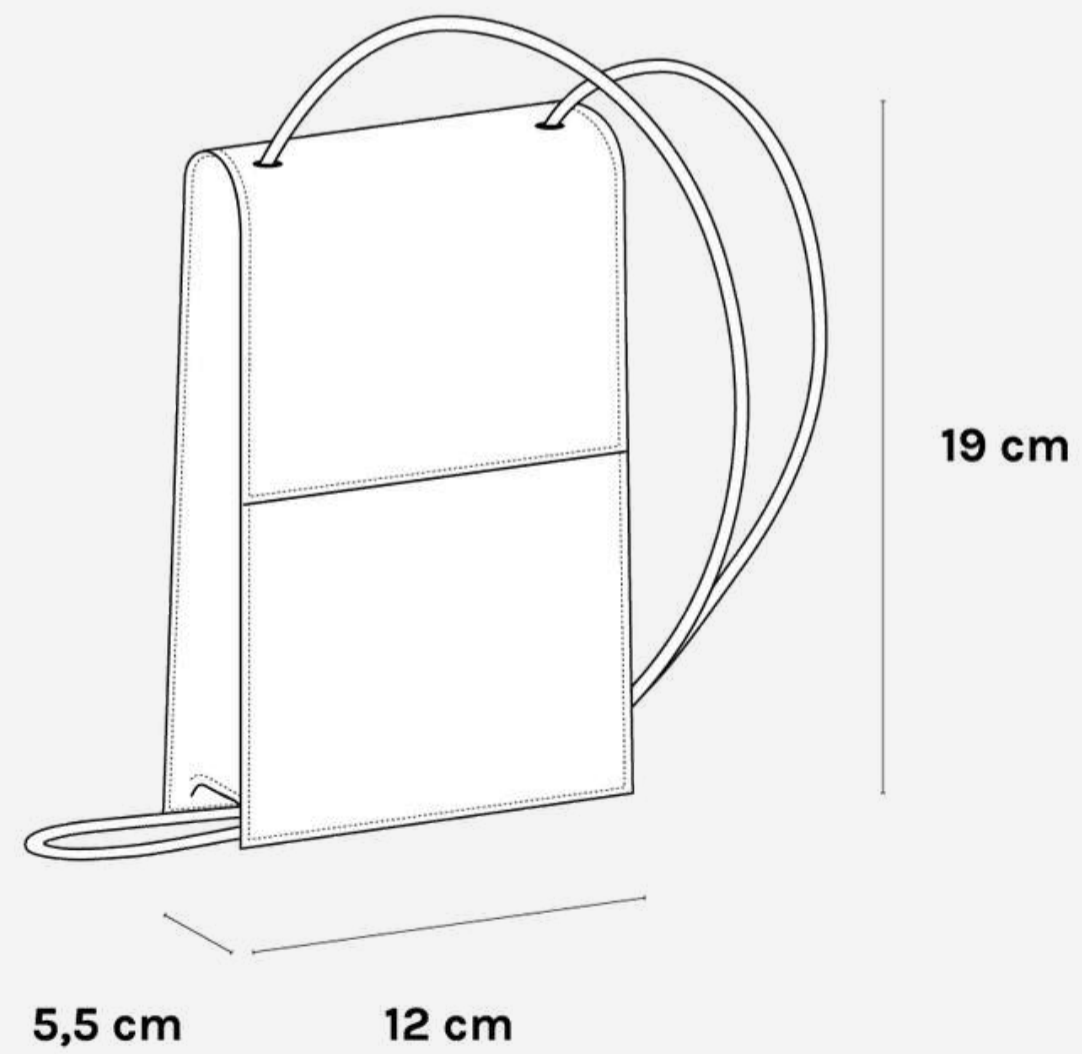

TEJA



ROJO



NEGRO BOOM



NUDE



CELESTE



VINO



CRUDO



TOSTADO



NAVY

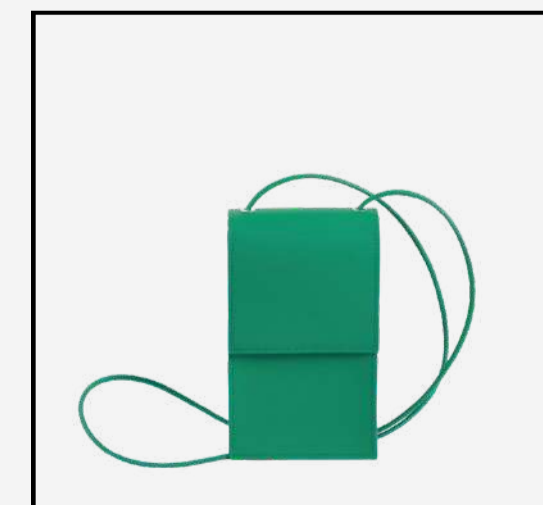

VERDE TRÉBOL

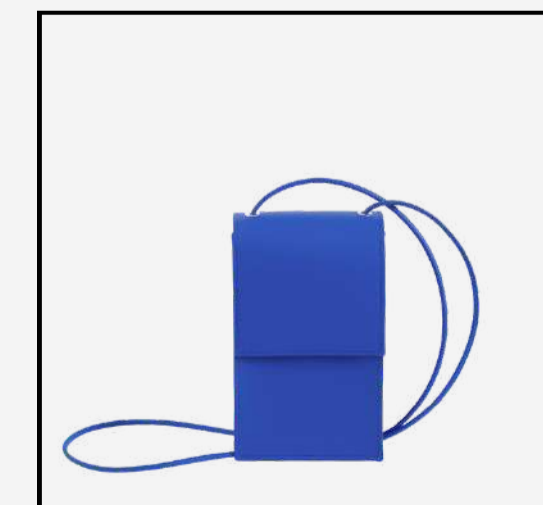

AZUL BIENHECHA



NEGRO MATE



POSICIONES | \*La modelo mide 1,70 m



50 cm

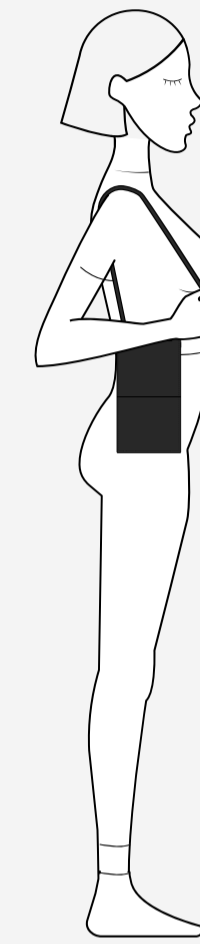

100 cm



120 cm

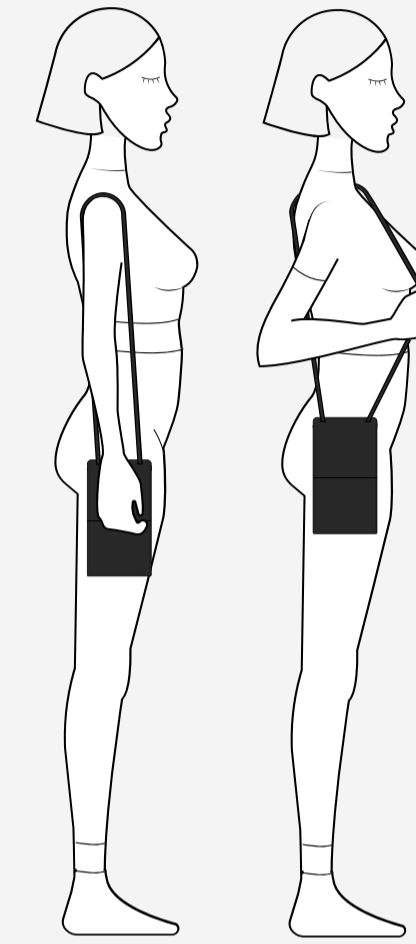

140 cm  
(INCLUIDO)

TOP VENTAS

**PACA**

COMPRAR

PVP RETAIL: 149,95€

\*Accede a tu cuenta para ver tu precio wholesale

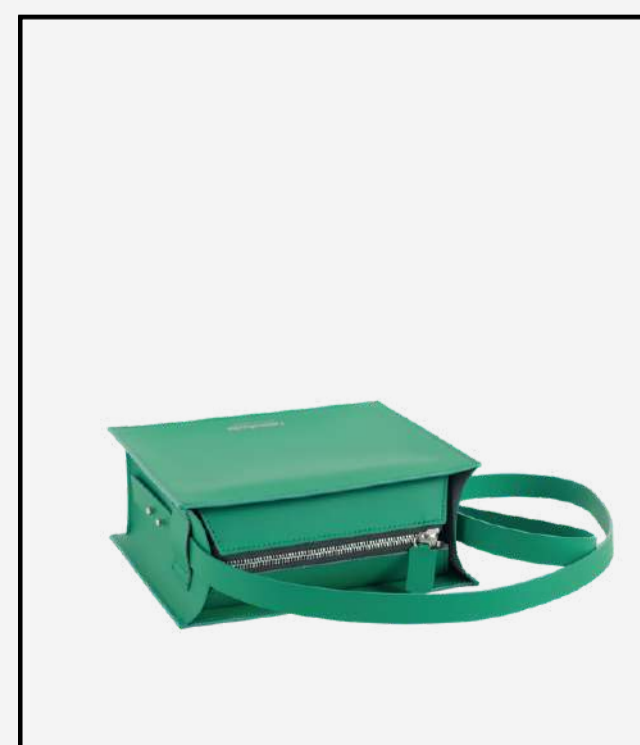
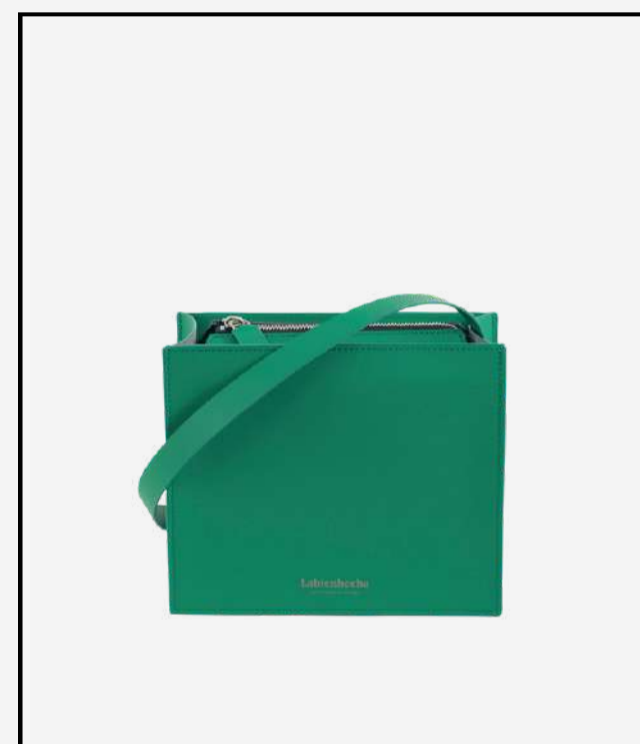

TOP VENTAS

## PEPA

Nuestro primer diseño y el segundo bolso más vendido de la historia de Labienhecha. Todo un icono superversátil gracias a su juego de correas intercambiables.

DESCÚBRELA

## TOP VENTAS

# PEPA

- Cierre de cremallera YKK
- Dos bolsillos interiores
- Cantos lujados y pintados a mano para una mayor protección
- Incluye una correa ajustable de 140 cm
- Correas extra disponibles: 60 cm, 70 cm, 80 cm, 100 cm, 120 cm o 140 cm
- Accesorios a juego

COMPRAR

EXTRAS

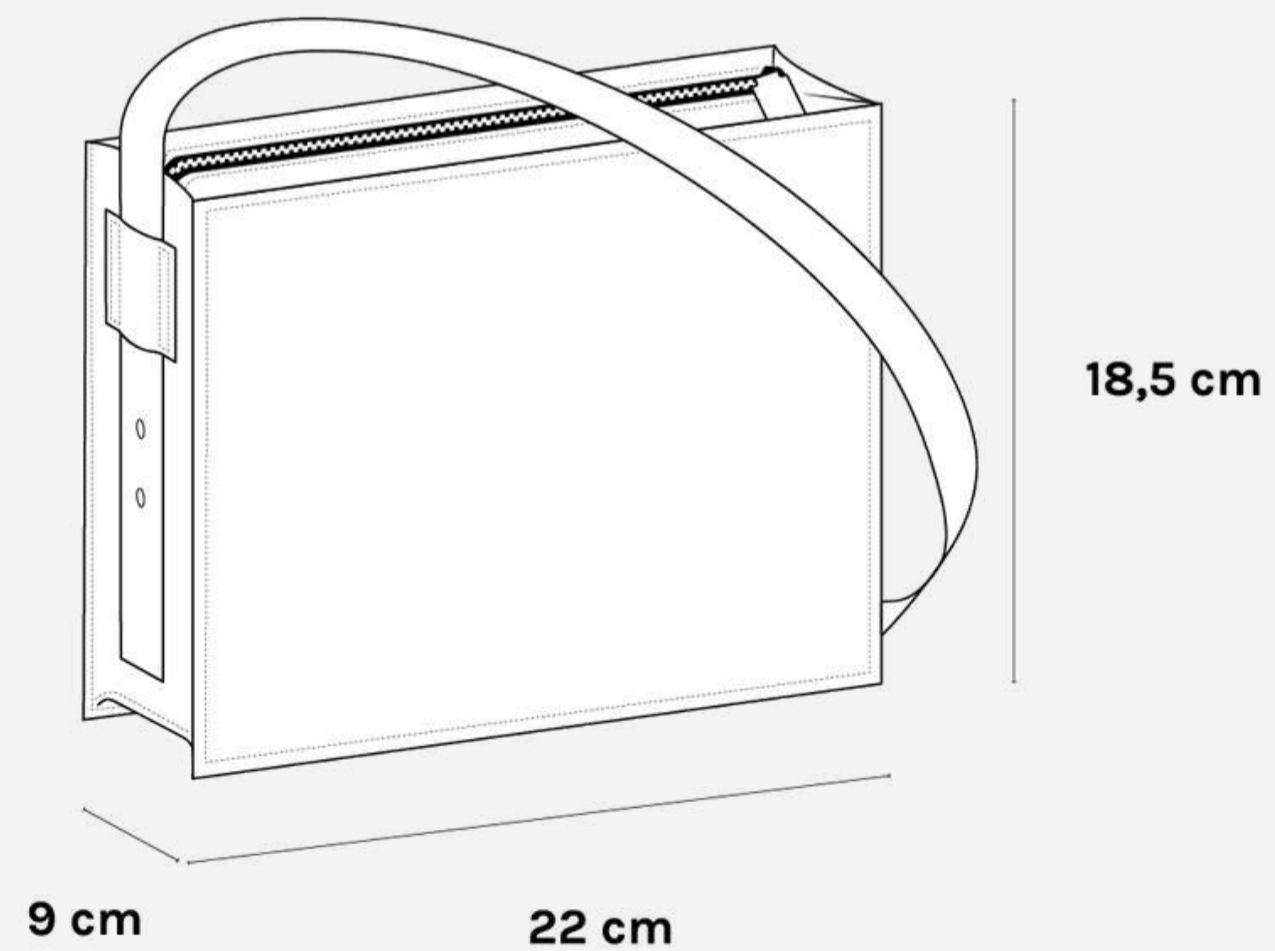

TEJA



ROJO



NEGRO BOOM



NUDE



CELESTE



VINO



CRUDO



TOSTADO

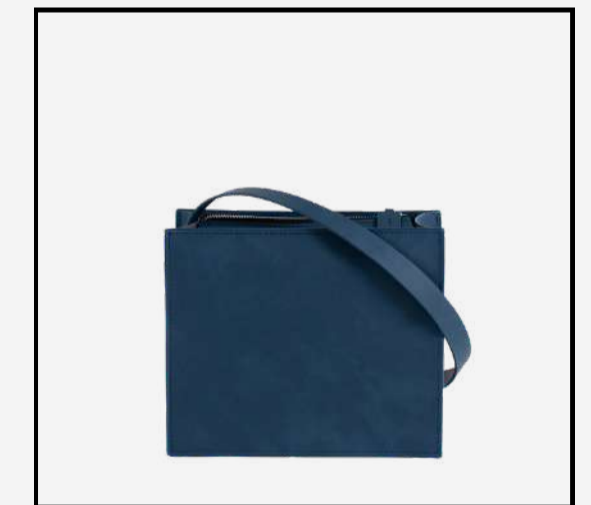

NAVY



VERDE TRÉBOL



AZUL BIENHECHA

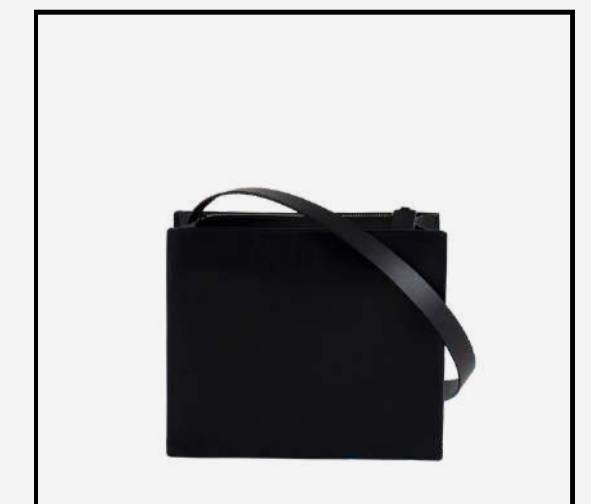

NEGRO MATE



POSICIONES | \*La modelo mide 1,70 m

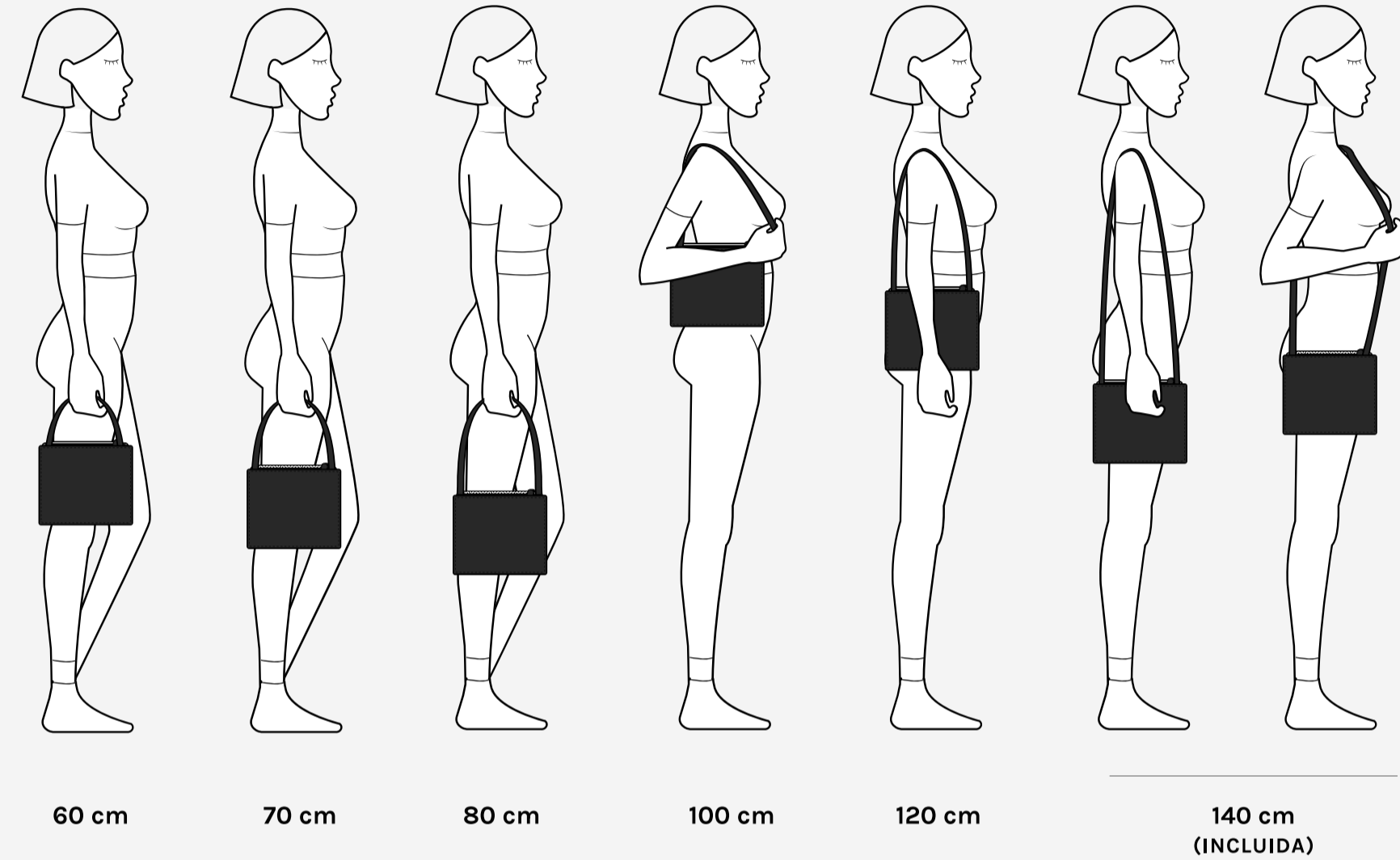

TOP VENTAS

## PEPA

COMPRAR

PVP RETAIL: 249,95€

\*Accede a tu cuenta para ver tu precio wholesale



GRAN TAMAÑO

## JOSEFA (LA PEPA GRANDE)

Es un TOP de la colección, sobre todo para lxs que necesitan ese plus de espacio a diario. Es la compañera perfecta para la ofi y uno de los bolsos unisex por excelencia.

DESCÚBRELA



GRAN TAMAÑO

## JOSEFA (LA PEPA GRANDE)

- Cierre de cremallera YKK
- Dos bolsillos interiores
- Cantos lujados y pintados a mano para una mayor protección
- Incluye una correa ajustable de 140 cm
- Correas extra disponibles: 80 cm, 100 cm, 120 cm o 140 cm
- Accesorios a juego

COMPRAR

EXTRAS

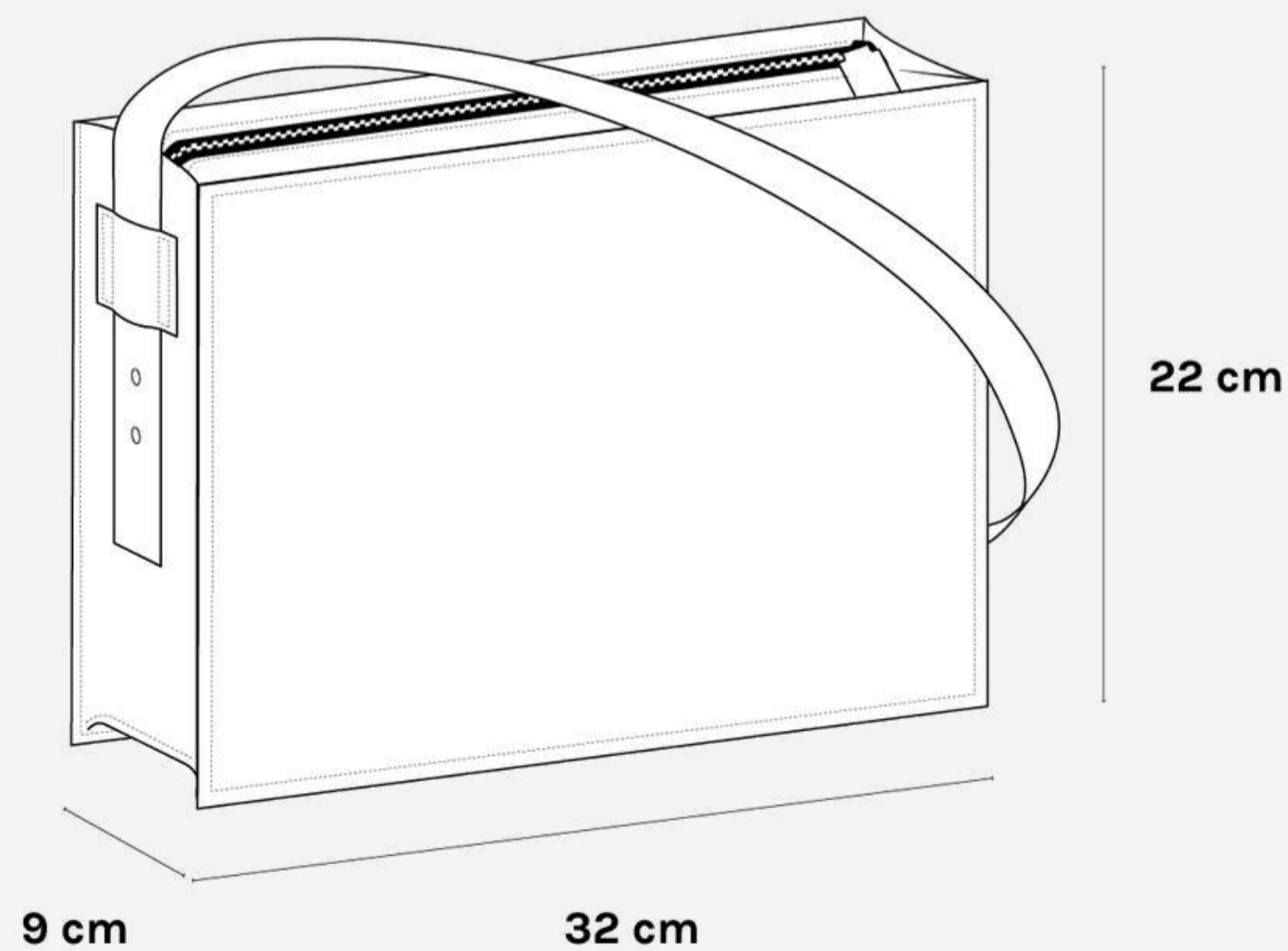

TEJA



ROJO



NEGRO BOOM



NUDE



CELESTE



VINO



CRUDO



TOSTADO



NAVY



VERDE TRÉBOL



AZUL BIENHECHA



NEGRO MATE



POSICIONES | \*La modelo mide 1,70 m

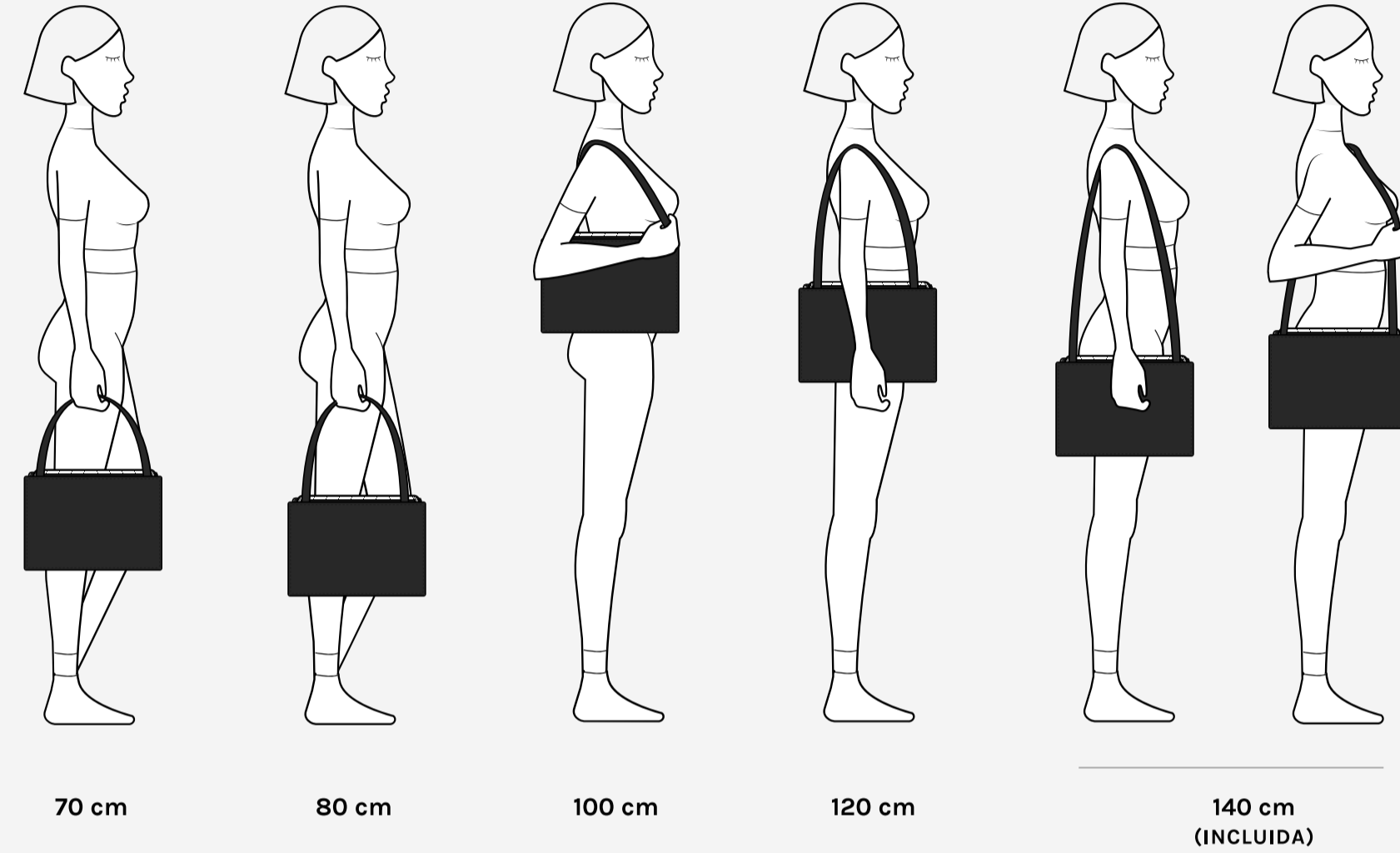

GRAN TAMAÑO

## JOSEFA (LA PEPA GRANDE)

COMPRAR

PVP RETAIL: 299,95€

\*Accede a tu cuenta para ver tu precio wholesale

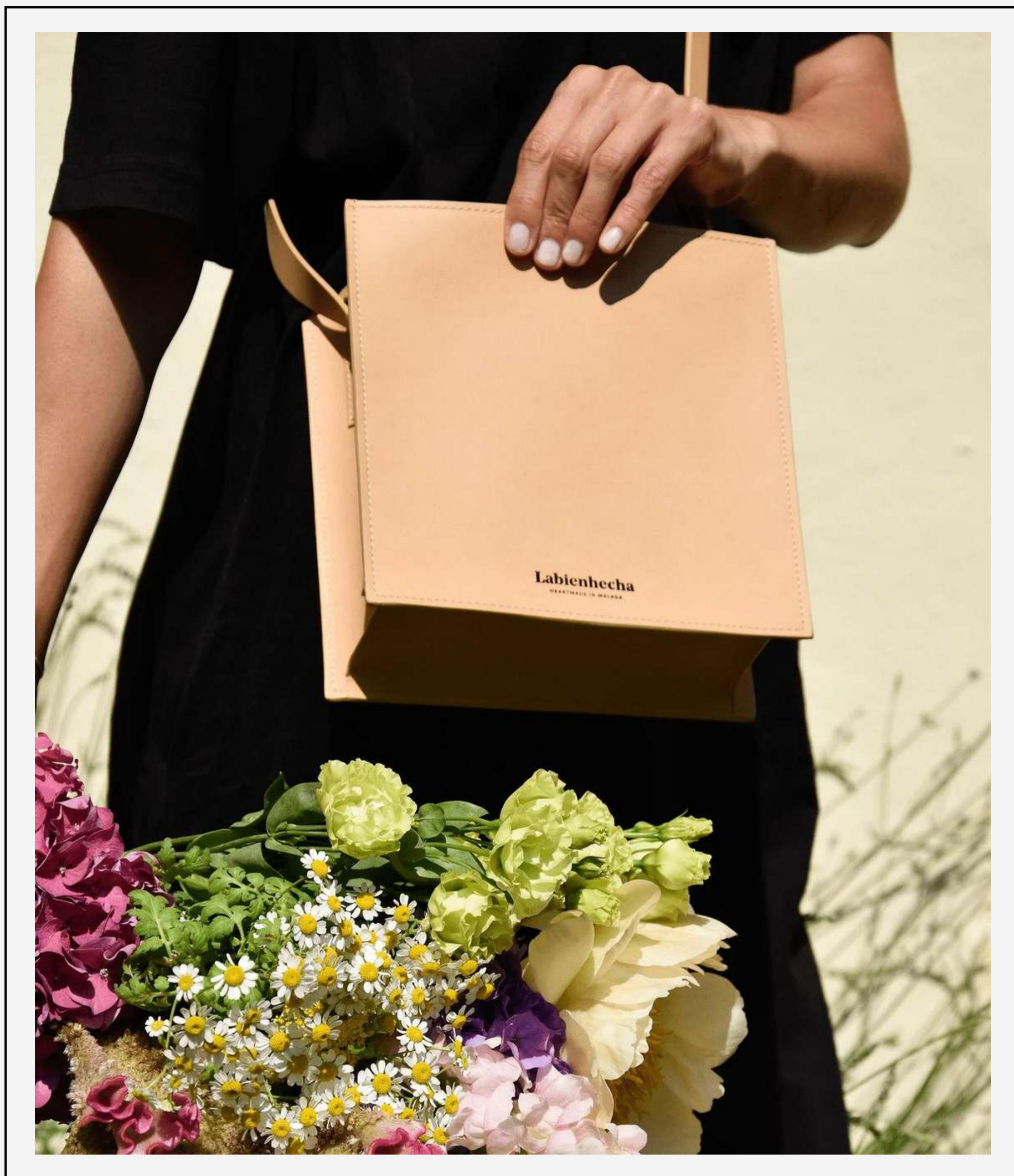

MINIMALISTA

## SOFÍA (HIJA)

Uno de los modelos más minimalistas, sencillos y con más personalidad de la colección. Lleva con nosotras desde el principio y sigue robando corazones.

DESCÚBRELA

MINIMALISTA

## SOFÍA (HIJA)

- Cierre de cremallera YKK
- Dos bolsillos interiores
- Cantos lujados y pintados a mano para una mayor protección
- Incluye una correa ajustable de 140 cm
- Correas extra disponibles: 60 cm, 70 cm, 80 cm, 100 cm, 120 cm o 140 cm
- Accesorios a juego

COMPRAR

EXTRAS

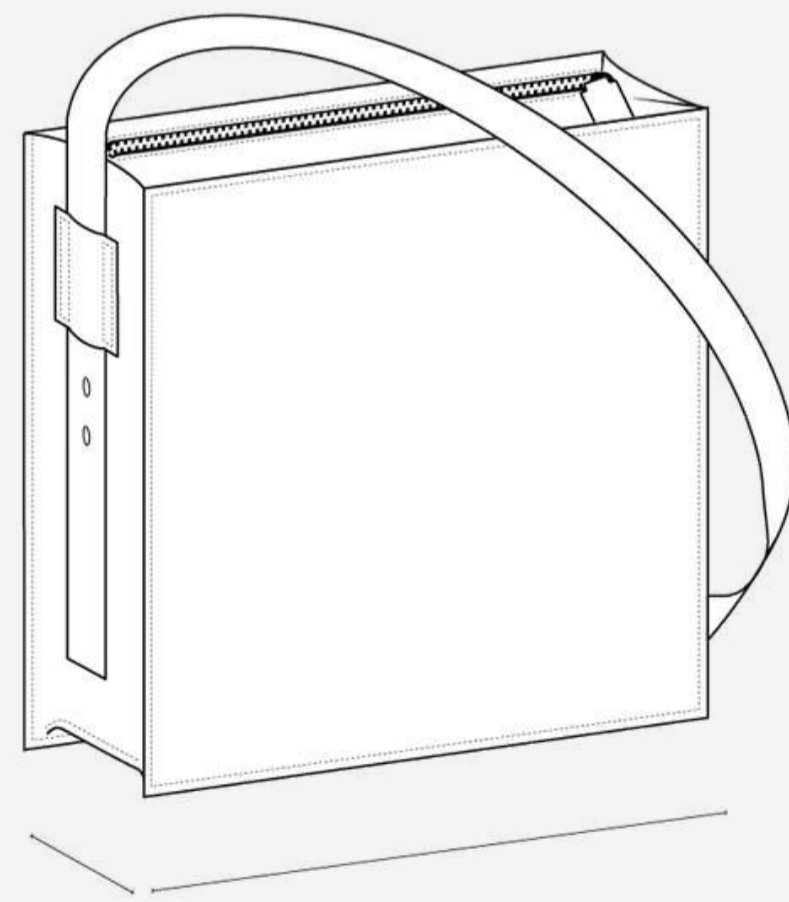

8,5 cm

20 cm

20 cm



TEJA



ROJO



NEGRO BOOM



NUDE



CELESTE



VINO



CRUDO



TOSTADO



NAVY



VERDE TRÉBOL



AZUL BIENHECHA



NEGRO MATE



POSICIONES | \*La modelo mide 1,70 m

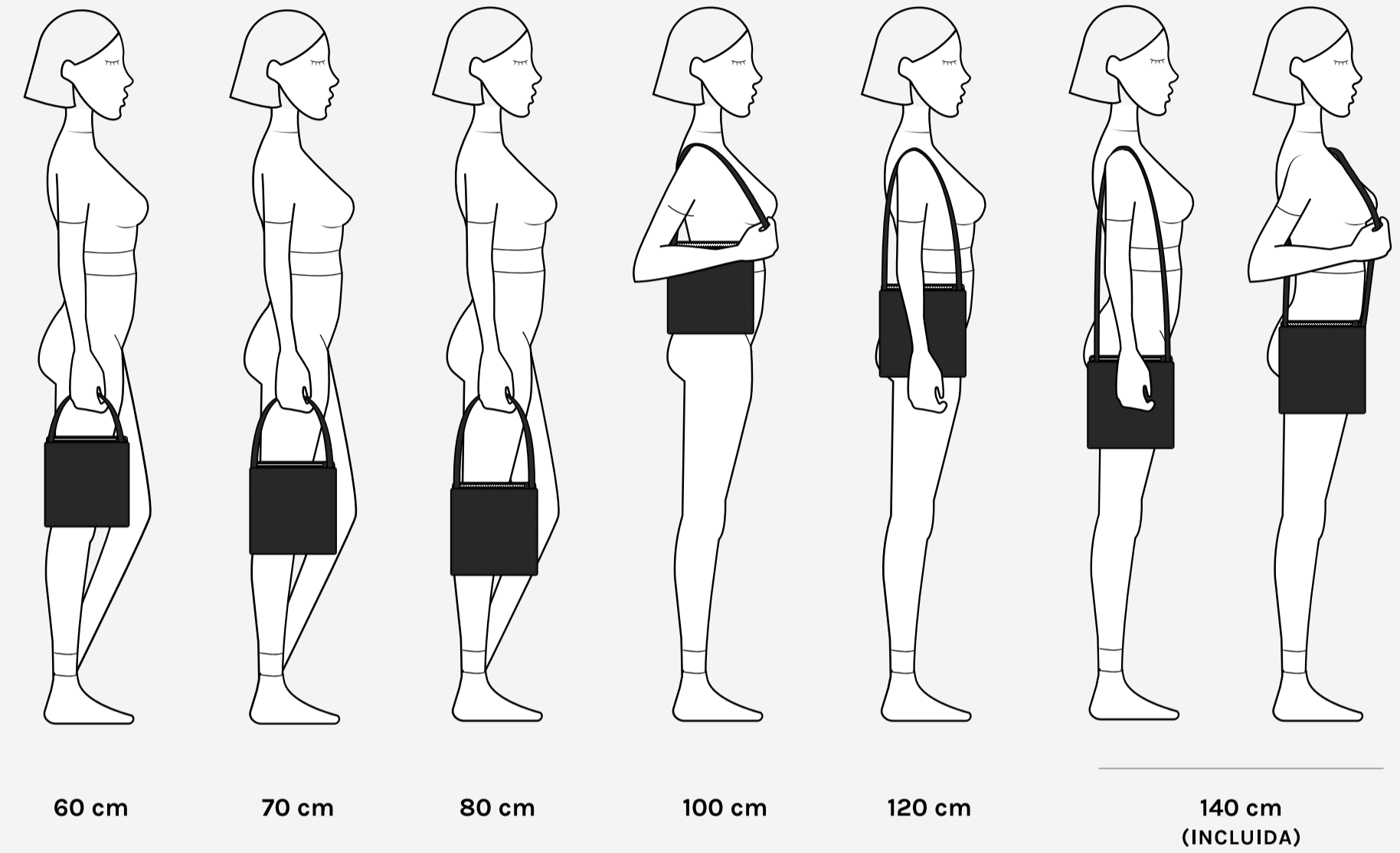

MINIMALISTA

## SOFÍA (HIJA)

COMPRAR

PVP RETAIL: 244,95€

\*Accede a tu cuenta para ver tu precio wholesale



UN PLUS DE ESPACIO

## SOFÍA (MADRE)

Un bolso de esos que valen para todo: espacioso y estructurado. Además, lleva en colección desde el principio. Perfecto para lxs que necesitan un plus de espacio.

DESCÚBRELA

UN PLUS DE ESPACIO

## SOFÍA (MADRE)

- Cierre de cremallera YKK
- Dos bolsillos interiores
- Cantos lujados y pintados a mano para una mayor protección
- Incluye una correa ajustable de 100 cm
- Correas extra disponibles: 70 cm, 80 cm, 100 cm, 120 cm o 140 cm
- Accesorios a juego

COMPRAR

EXTRAS

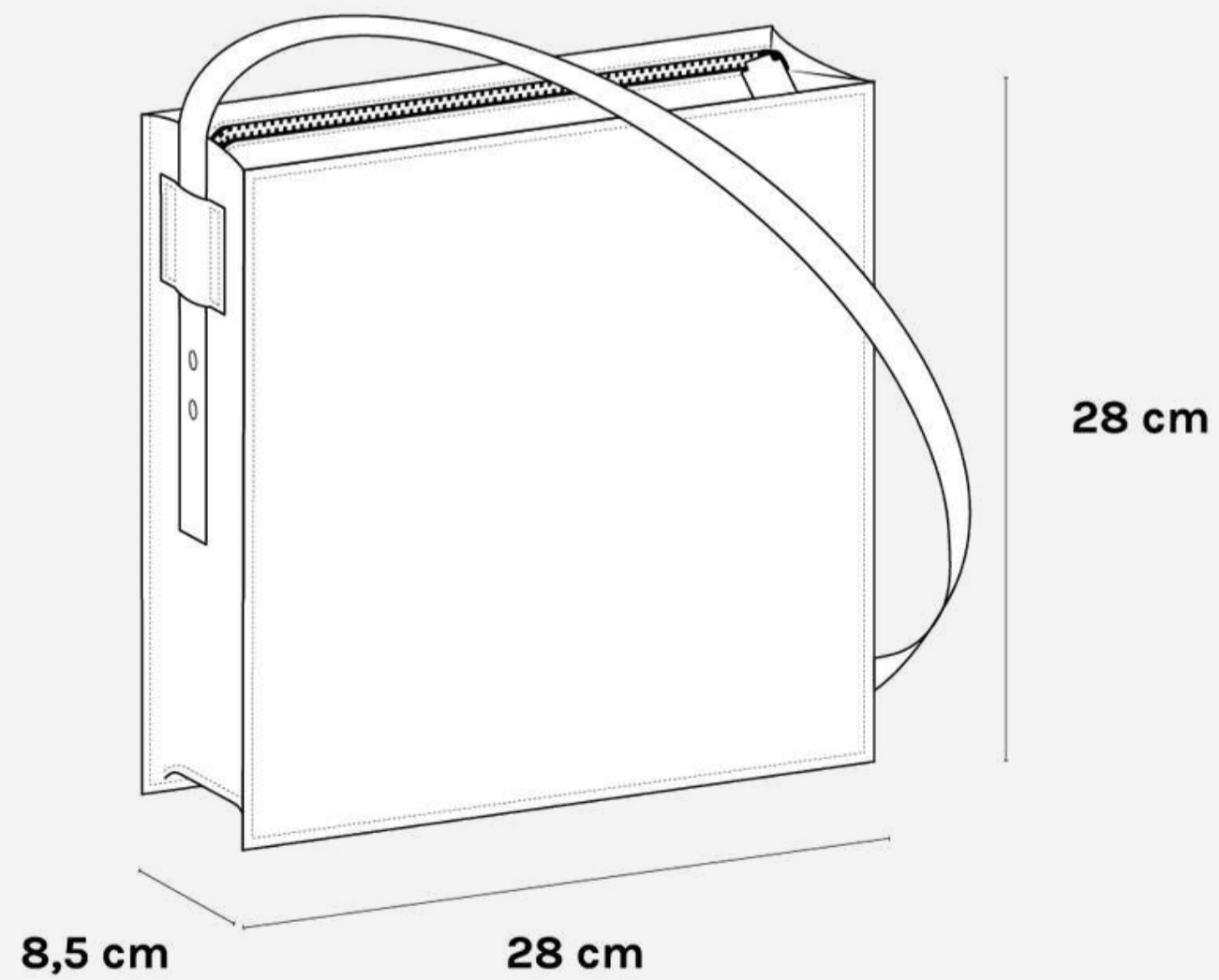

TEJA



ROJO



NEGRO BOOM



NUDE



CELESTE



VINO



CRUDO



TOSTADO



NAVY



VERDE TRÉBOL



AZUL BIENHECHA



NEGRO MATE



POSICIONES | \*La modelo mide 1,70 m

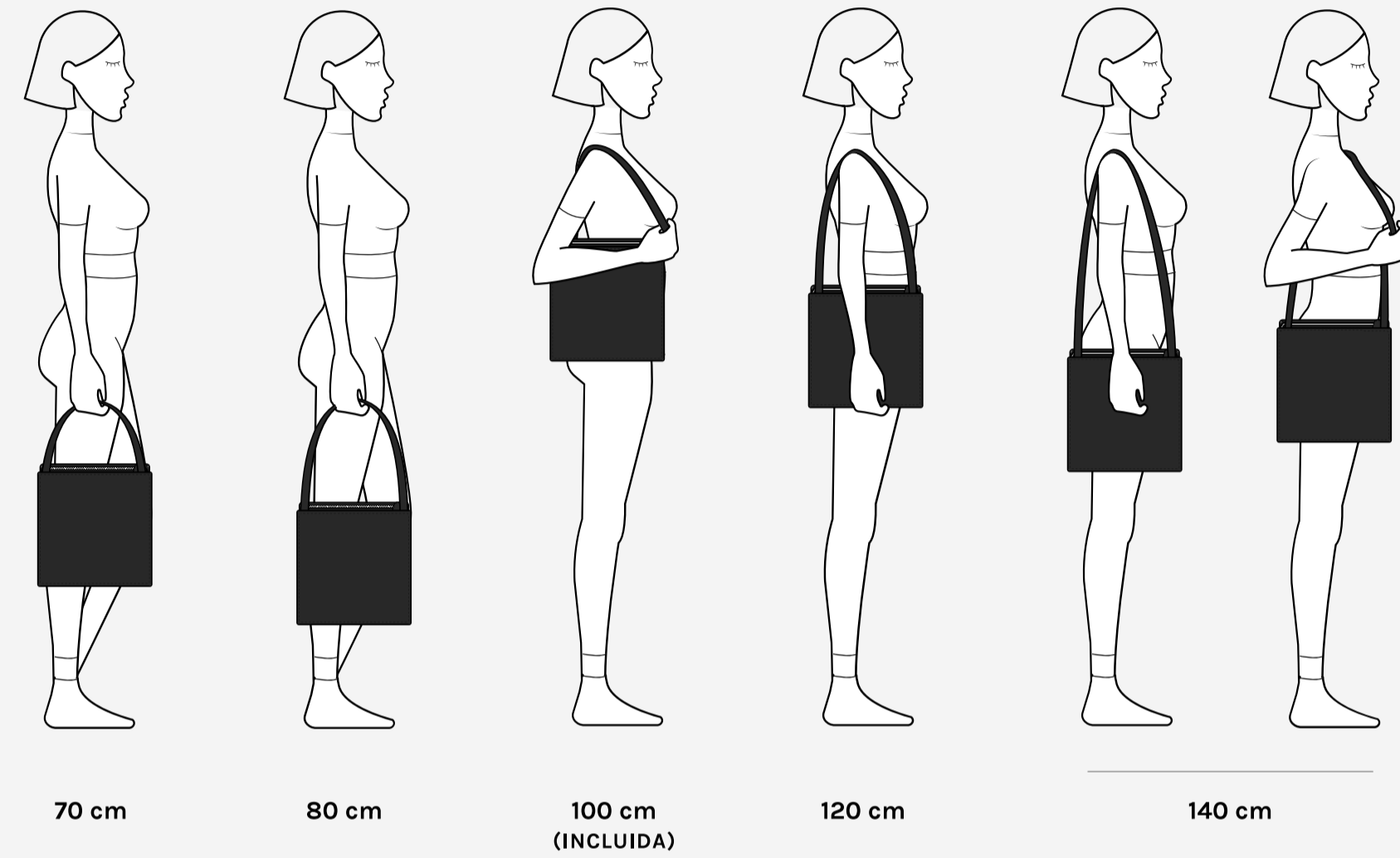

UN PLUS DE ESPACIO

## SOFÍA (MADRE)

COMPRAR

PVP RETAIL: 299,95€

\*Accede a tu cuenta para ver tu precio wholesale





TOP VENTAS

## BERNARDITA

Un bolso con forma de media luna que rebosa encanto. Su solapa pura y minimalista le da el toque de personalidad que completa cualquier look.

DESCÚBRELA

TOP VENTAS

# BERNARDITA

- Cierre de imán con solapa
- Dos bolsillos interiores (uno de ellos tarjetero)
- Cantos lujados y pintados a mano para una mayor protección
- Incluye un cordón ajustable de 140 cm
- Cordones extra disponibles: 50 cm, 100 cm, 120 cm o 140 cm
- Accesorios a juego

COMPRAR

EXTRAS

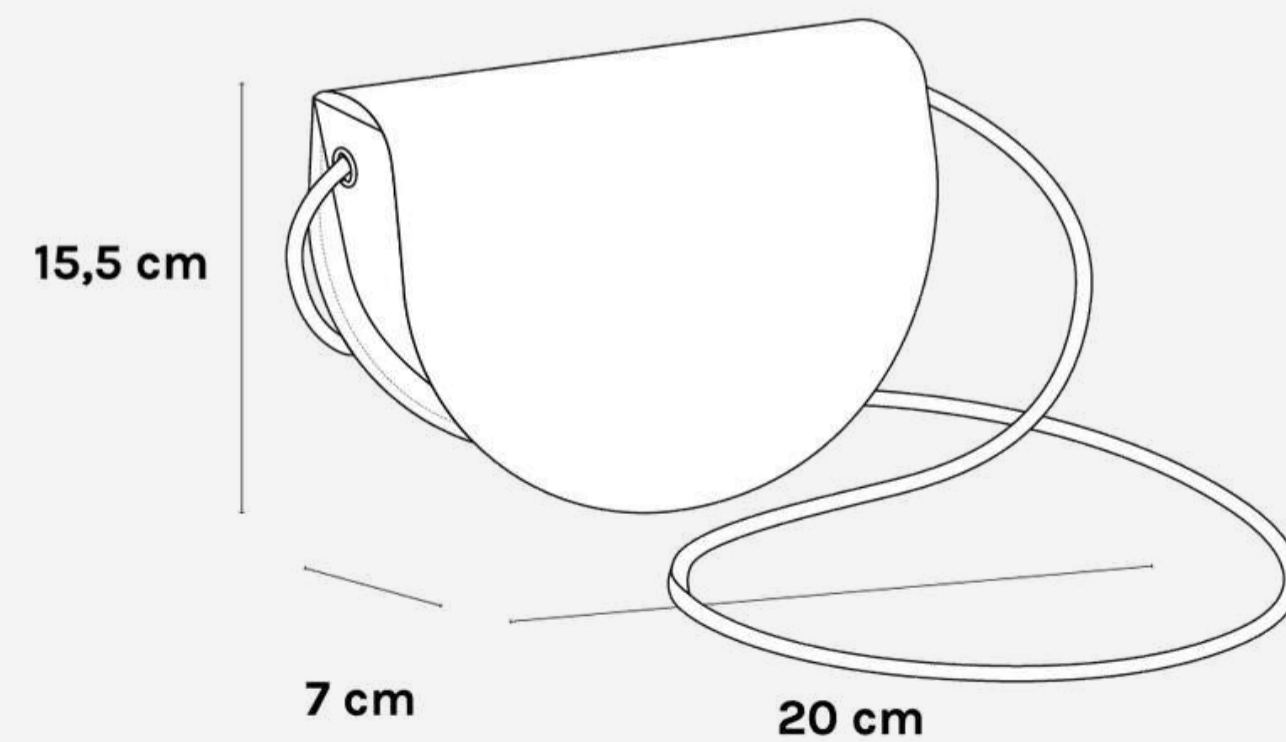

TEJA



ROJO



NEGRO BOOM



NUDE



CELESTE



VINO



CRUDO



TOSTADO



NAVY



VERDE TRÉBOL

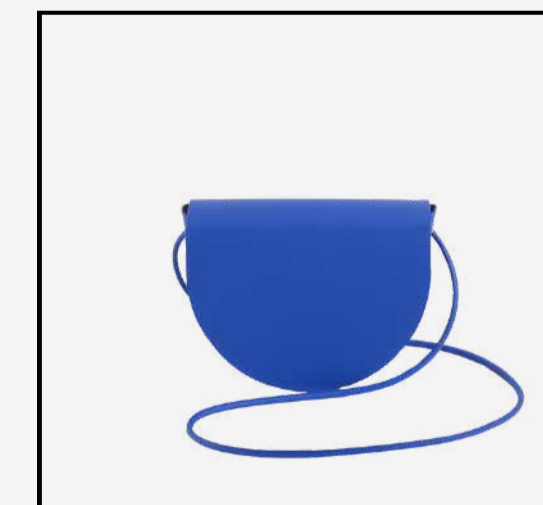

AZUL BIENHECHA



NEGRO MATE



POSICIONES | \*La modelo mide 1,70 m



50 cm

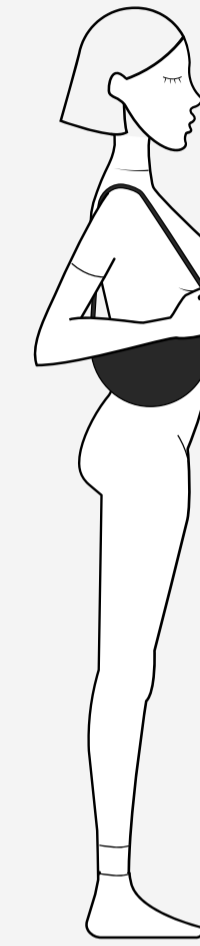

100 cm



120 cm

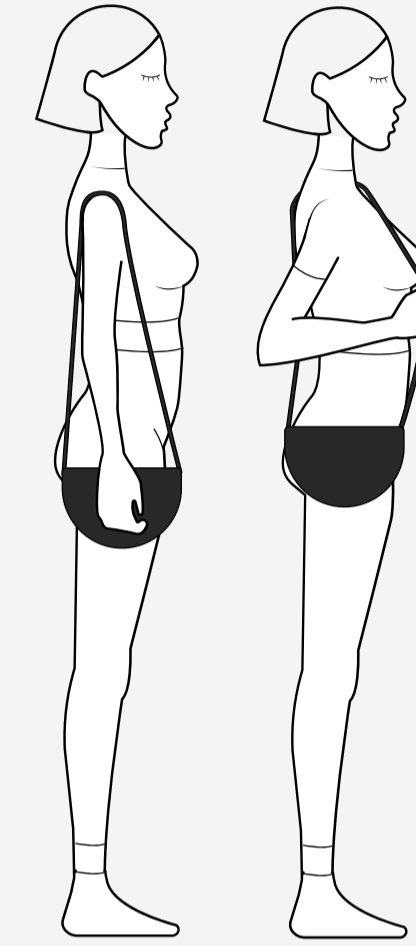

140 cm  
(INCLUIDO)

TOP VENTAS

## BERNARDITA

COMPRAR

PVP RETAIL: 219,95€

\*Accede a tu cuenta para ver tu precio wholesale

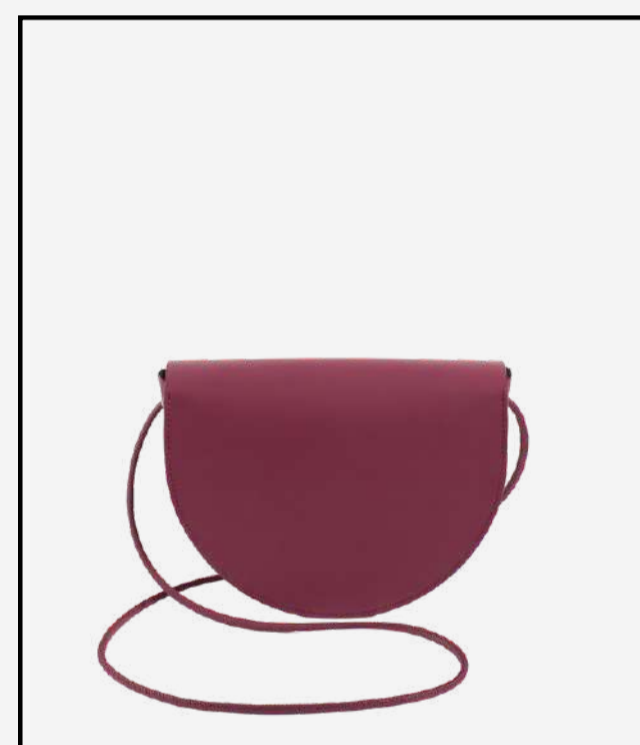
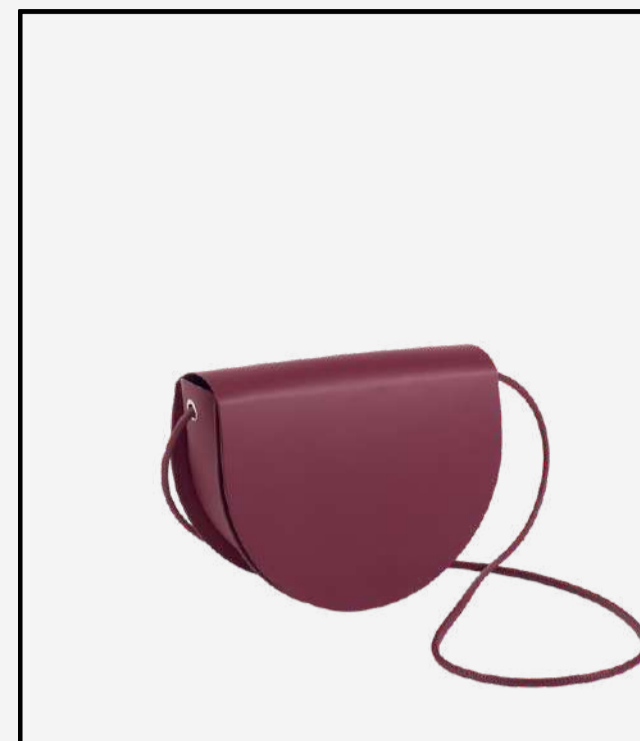
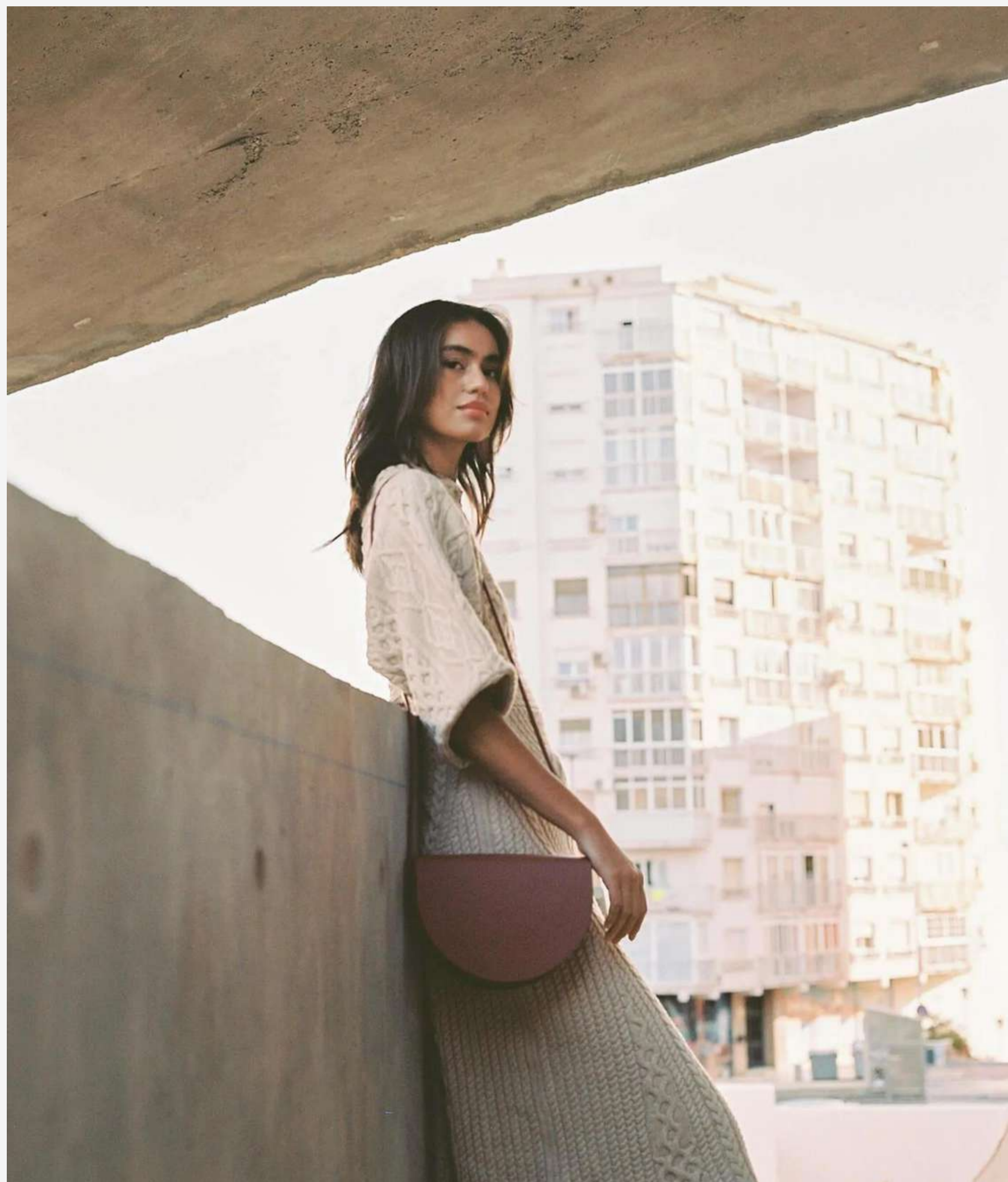

TOP VENTAS

## BERNARDA

Un bolso con forma de media luna que rebosa encanto. Su solapa pura y minimalista le da el toque de personalidad que completa cualquier look. La hermana mayor de Bernardita.

DESCÚBRELA

TOP VENTAS

## BERNARDA

- Cierre de imán con solapa
- Dos bolsillos interiores (uno de ellos tarjetero)
- Cantos lujados y pintados a mano para una mayor protección
- Incluye un cordón ajustable de 140 cm
- Cordones extra disponibles: 50 cm, 100 cm, 120 cm o 140 cm
- Accesorios a juego

COMPRAR

EXTRAS

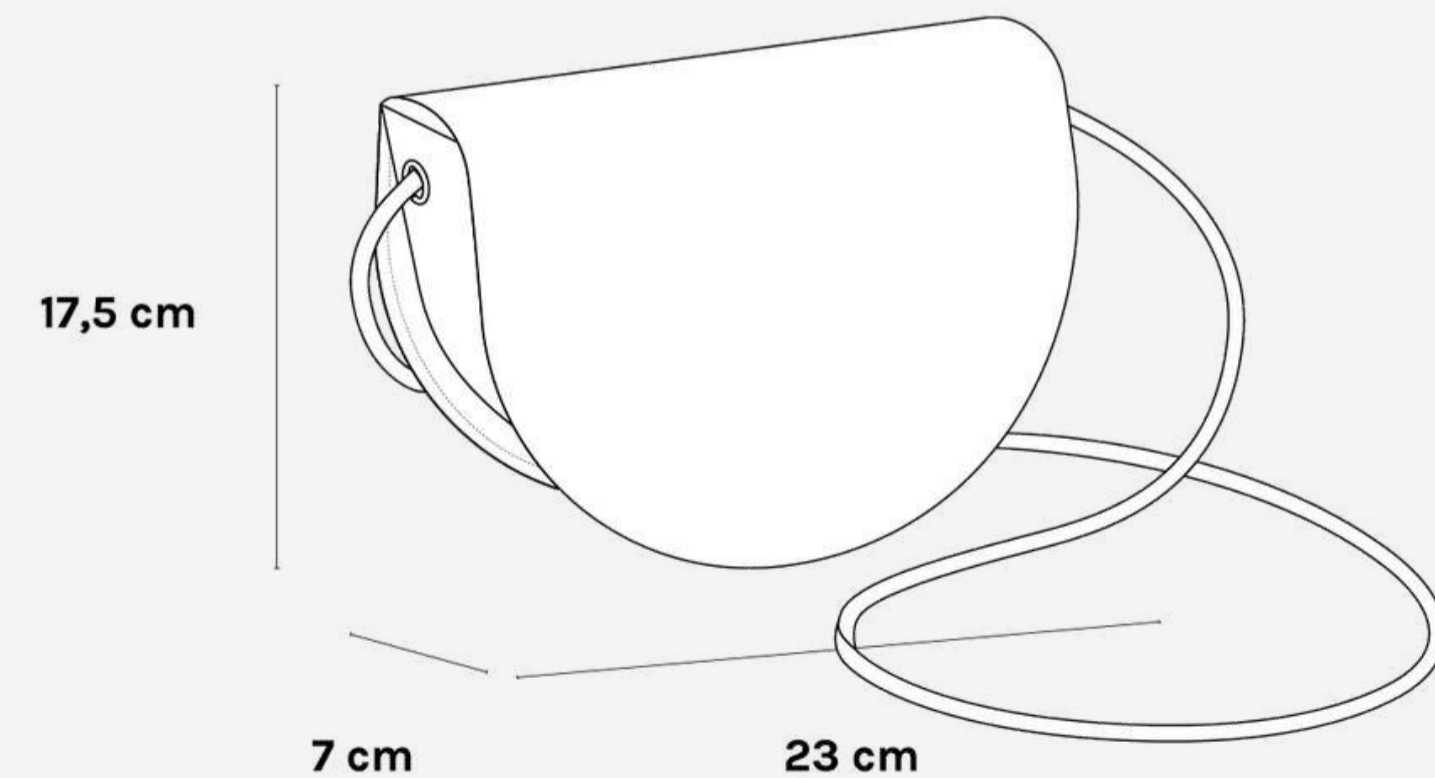

TEJA



ROJO



NEGRO BOOM



NUDE



CELESTE



VINO



CRUDO



TOSTADO



NAVY



VERDE TRÉBOL



AZUL BIENHECHA



NEGRO MATE



POSICIONES | \*La modelo mide 1,70 m

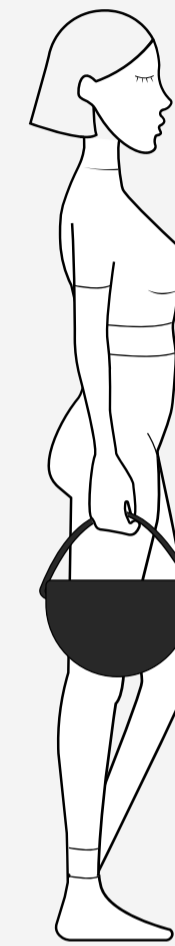

50 cm

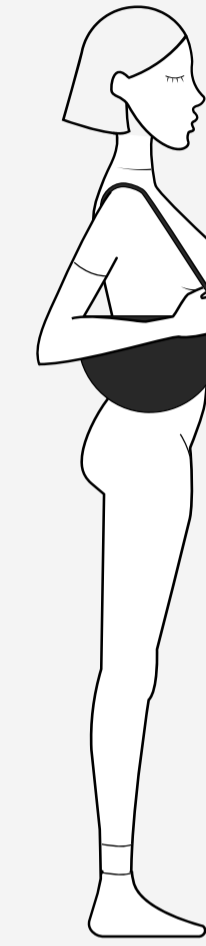

100 cm



120 cm



140 cm  
(INCLUIDO)

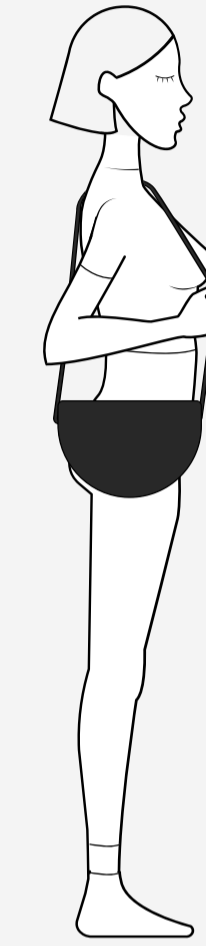

TOP VENTAS

## BERNARDA

COMPRAR

PVP RETAIL: 239,95€

\*Accede a tu cuenta para ver tu precio wholesale

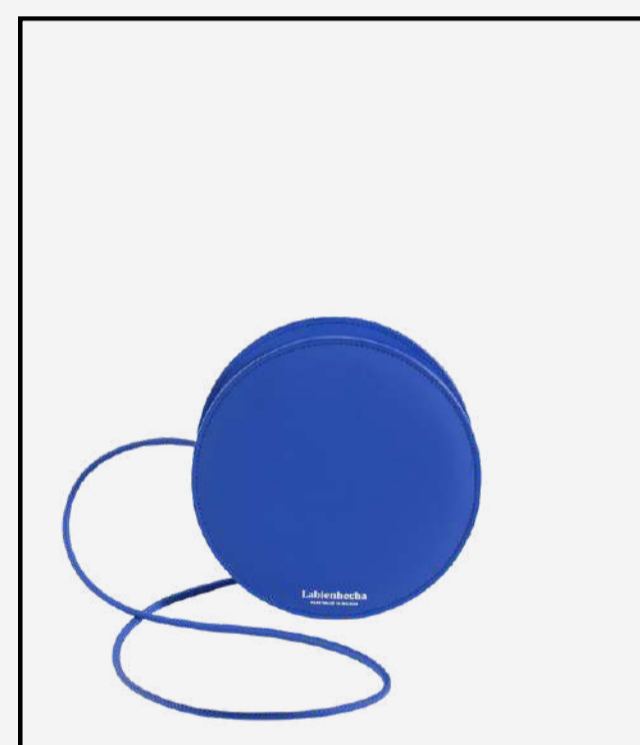
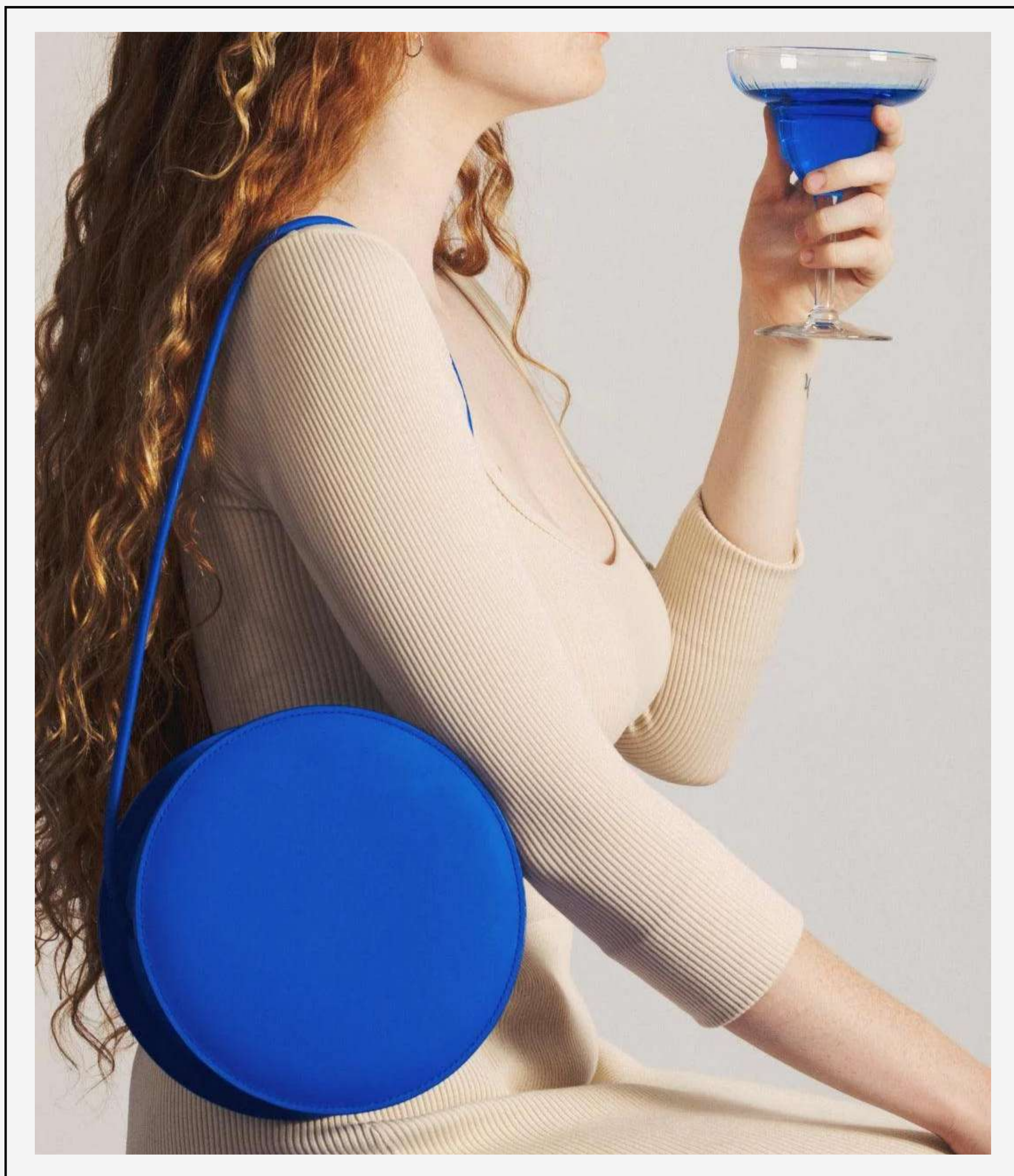

UNA JOYITA

## MARCELINA

Un bolso de tamaño pequeño para llevar lo esencial. Su forma totalmente circular lo hace muy especial. Siempre nos dicen que es un bolso de coleccionista.

DESCÚBRELA

UNA JOYITA

## MARCELINA

- Cierre de cremallera YKK (muy gustosita)
- Un bolsillo interior
- Cantos lujados y pintados a mano para una mayor protección
- Incluye un cordón ajustable de 140 cm
- Cordones extra disponibles: 50 cm, 100 cm, 120 cm o 140 cm
- Accesorios a juego

COMPRAR

EXTRAS

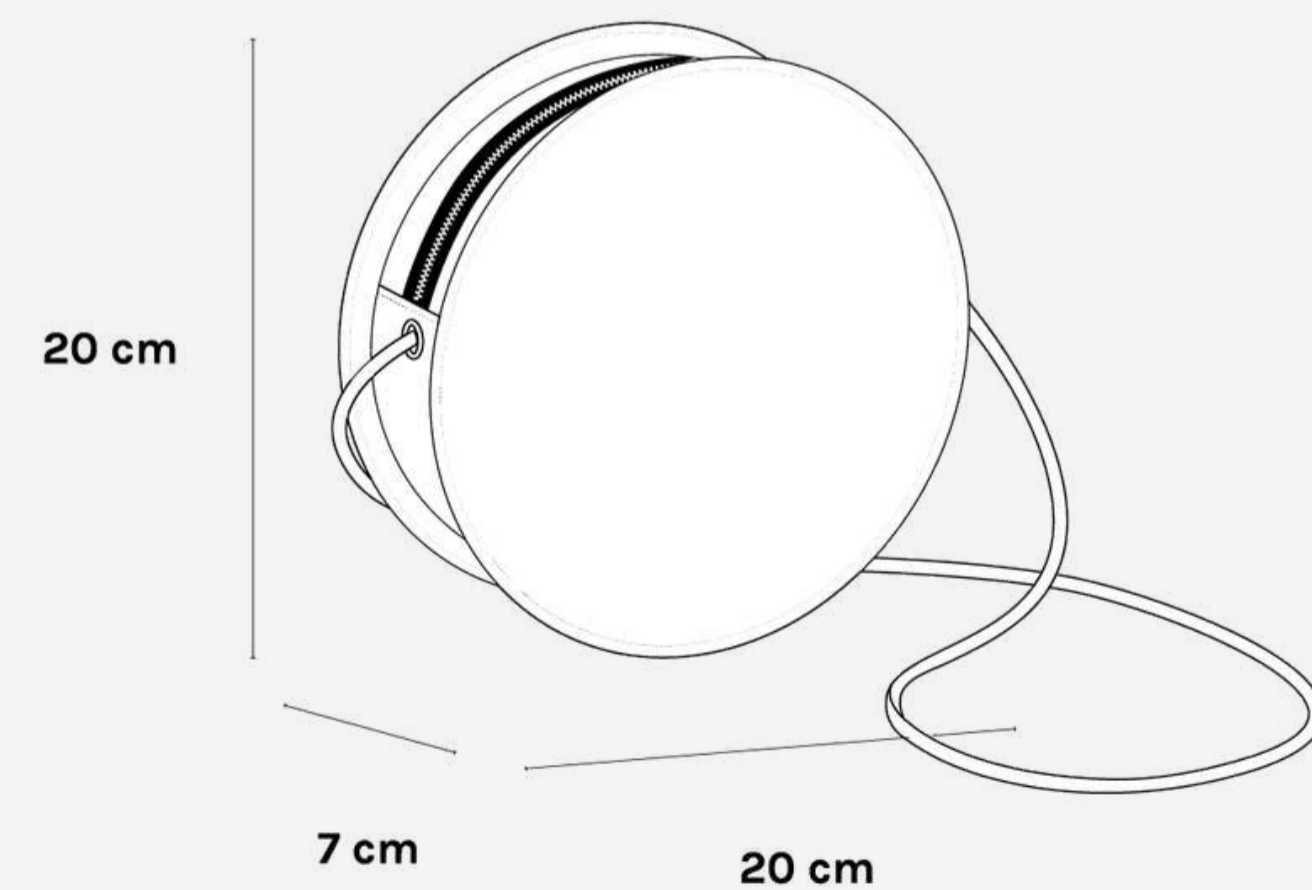

TEJA

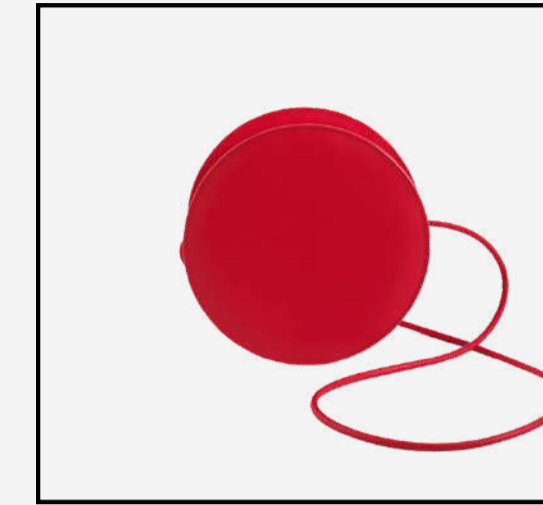

ROJO



NEGRO BOOM



NUDE

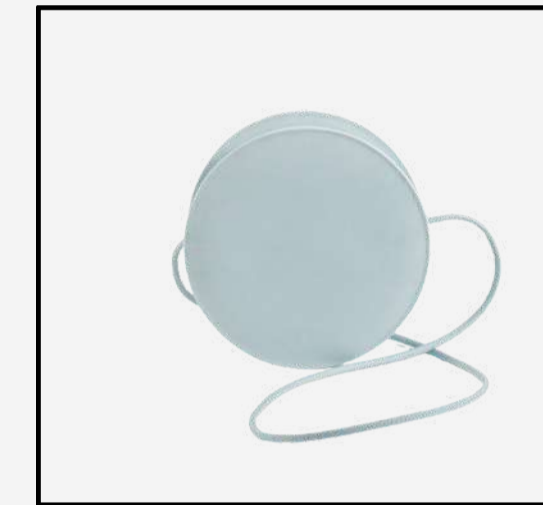

CELESTE

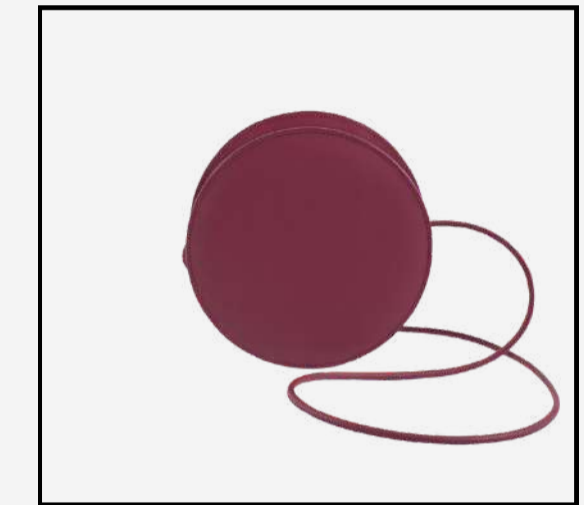

VINO



CRUDO



TOSTADO



NAVY

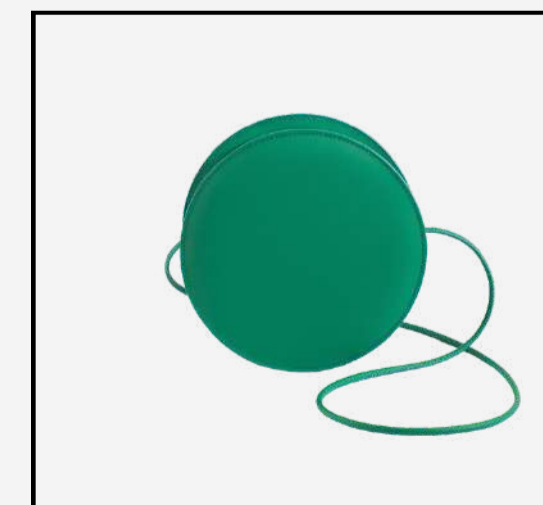

VERDE TRÉBOL



AZUL BIENHECHA



NEGRO MATE





POSICIONES | \*La modelo mide 1,70 m



50 cm

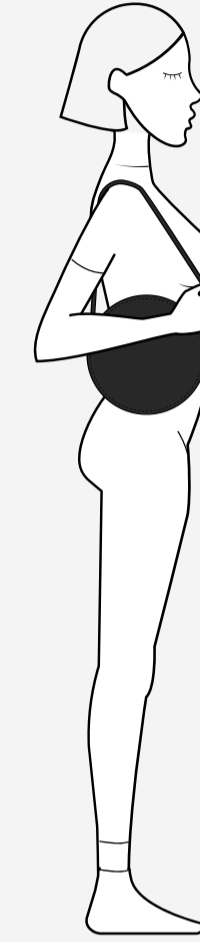

100 cm



120 cm



140 cm  
(INCLUIDO)

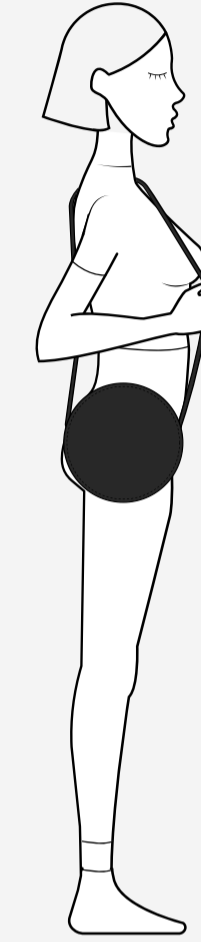

UNA JOYITA

## MARCELINA

COMPRAR

PVP RETAIL: 269,95€

\*Accede a tu cuenta para ver tu precio wholesale

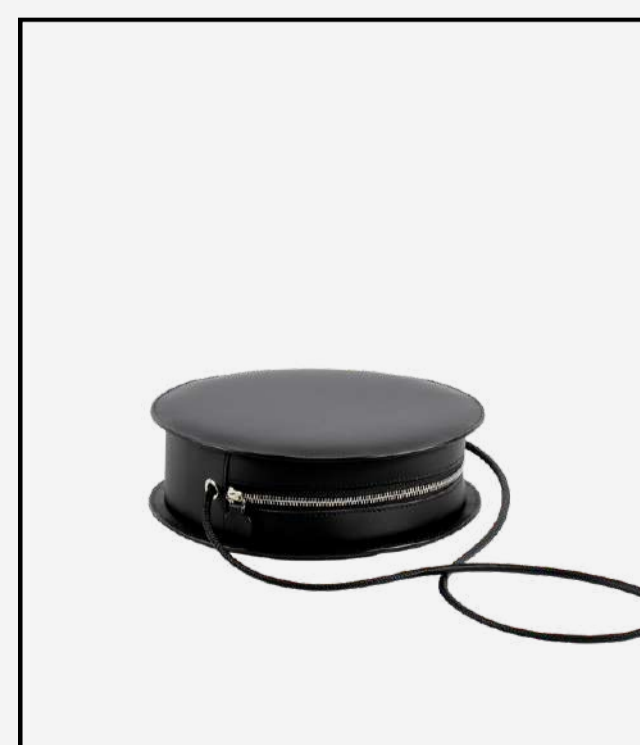
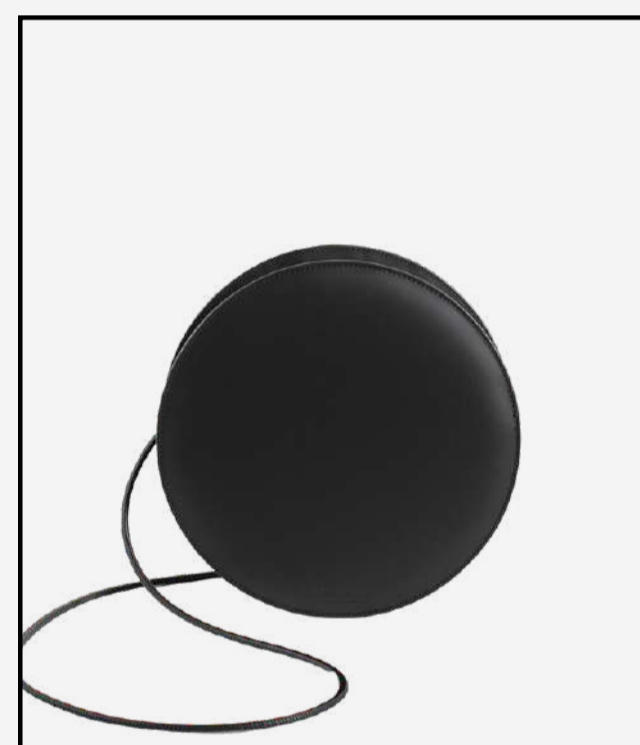
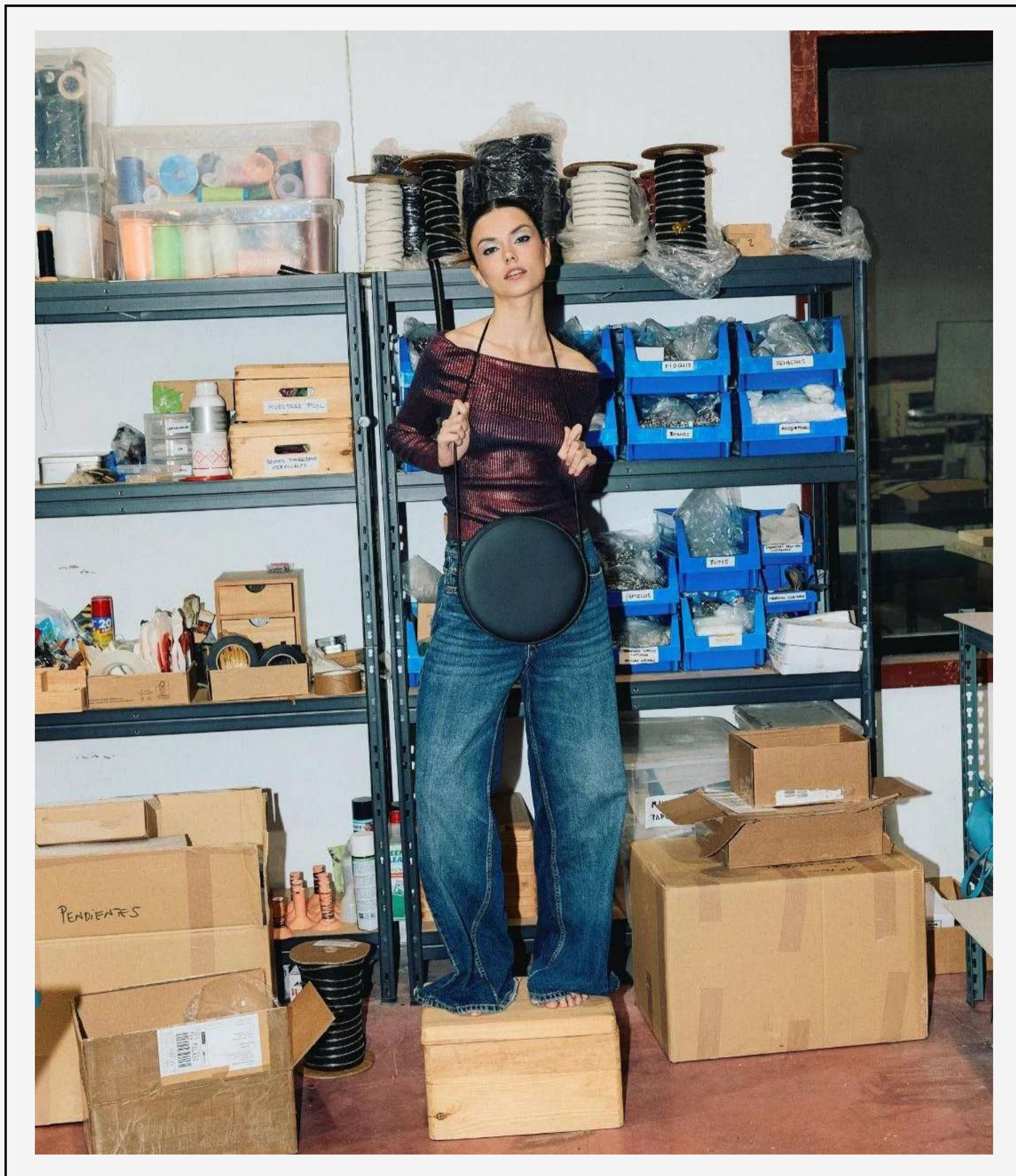

UNA JOYA

## MARCELA

Un bolso de tamaño pequeño para llevar lo esencial. Su forma totalmente circular lo hace muy especial. Siempre nos dicen que es un bolso de coleccionista. La hermana mayor de Marcelina.

DESCÚBRELA

UNA JOYA

## MARCELA

- Cierre de cremallera YKK (muy gustosita)
- Un bolsillo interior
- Cantos lujados y pintados a mano para una mayor protección
- Incluye un cordón ajustable de 140 cm
- Cordones extra disponibles: 70 cm, 80 cm, 100 cm, 120 cm o 140 cm
- Accesorios a juego

COMPRAR

EXTRAS

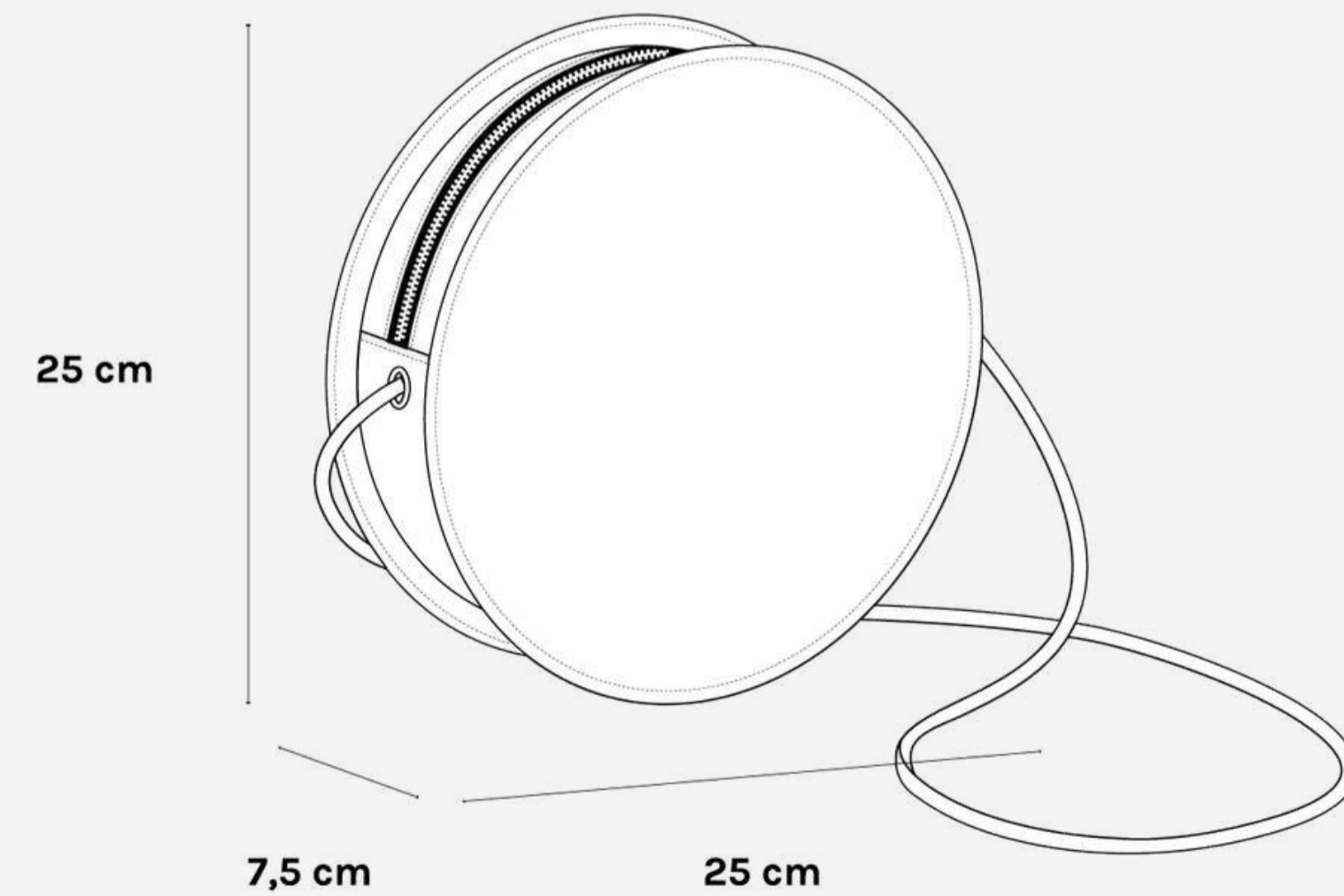

TEJA



ROJO



NEGRO BOOM



NUDE



CELESTE

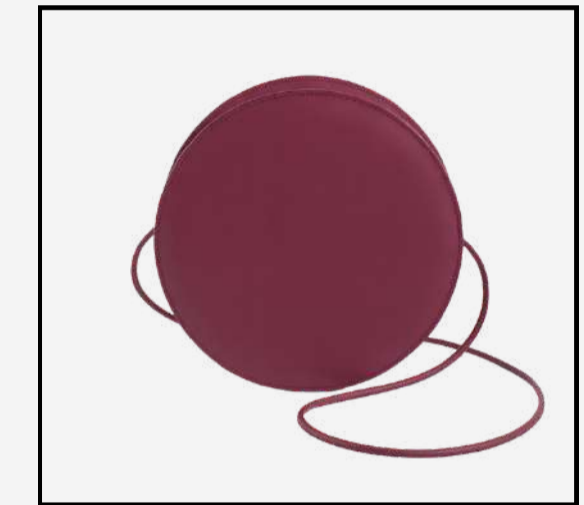

VINO



CRUDO



TOSTADO



NAVY



VERDE TRÉBOL



AZUL BIENHECHA



NEGRO MATE



POSICIONES | \*La modelo mide 1,70 m



50 cm



100 cm



120 cm

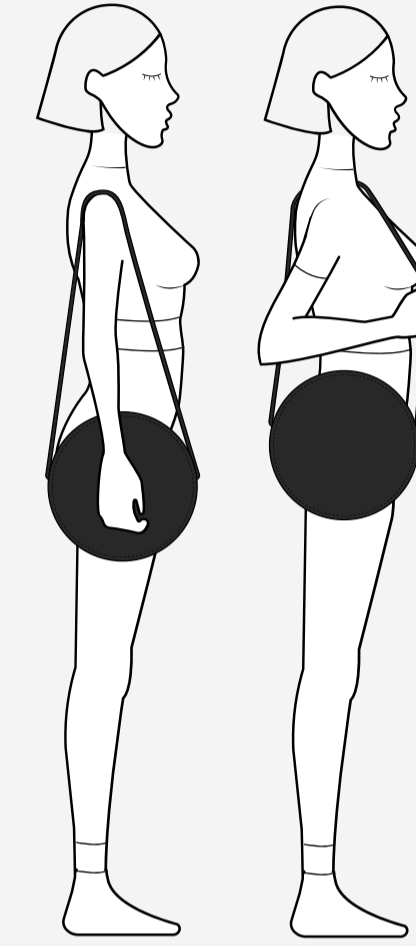

140 cm  
(INCLUIDO)

UNA JOYA

## MARCELA

COMPRAR

PVP RETAIL: 299,95€

\*Accede a tu cuenta para ver tu precio wholesale

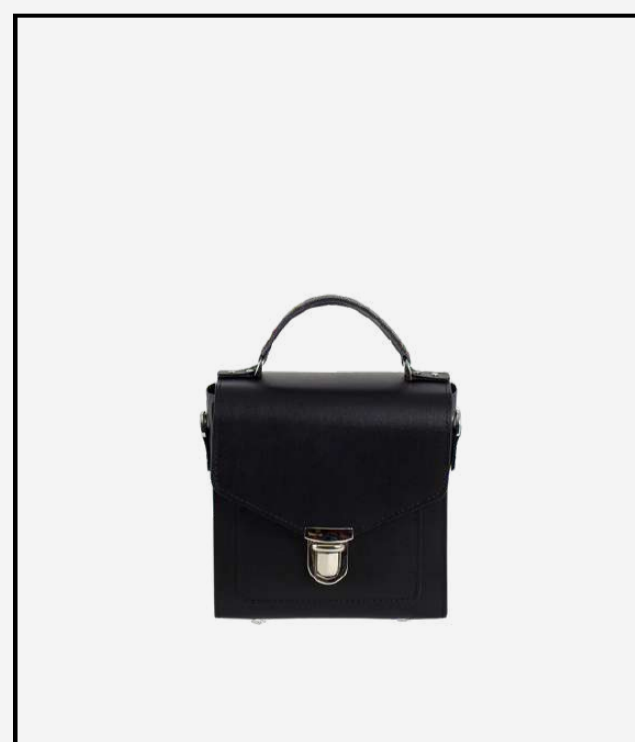
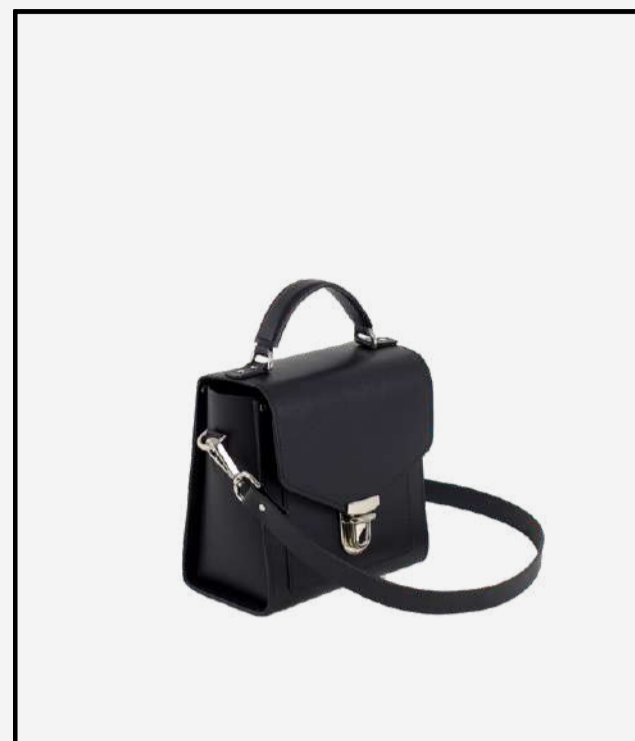

TOP VENTAS

## RAMONA

Una de las joyas de la corona. De las más deseadas.  
Disponibile en todos los colores y en dos tamaños.  
Opciones extra.

DESCÚBRELA

## TOP VENTAS

# RAMONA

- Dos bolsillos interiores (uno de ellos tarjetero)
- Broche de cierre libre de níquel
- Cantos lujados y pintados a mano para una mayor protección
- Base y solapa reforzados para que no pierda su estructura
- Patitas de metal libres de níquel
- Una correa de mosquetón incluida (120 cm)
- Correas extra disponibles

COMPRAR

EXTRAS

LA GRANDE

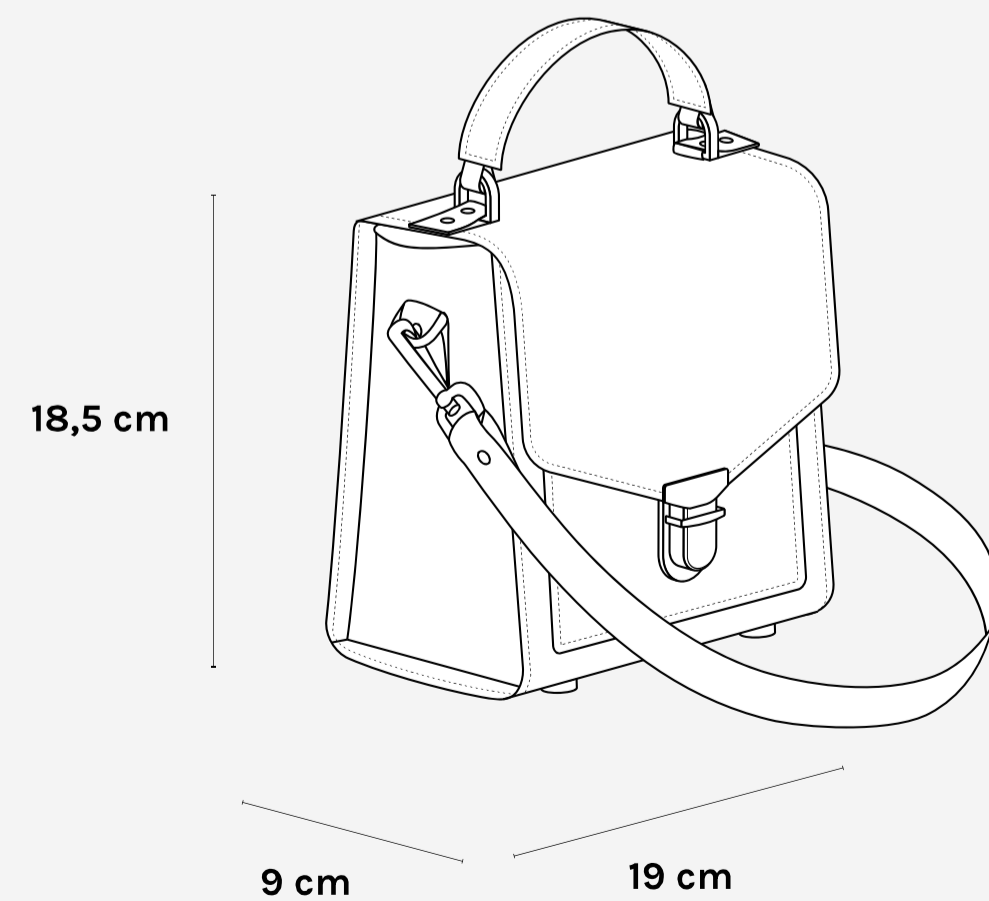

LA CHICA

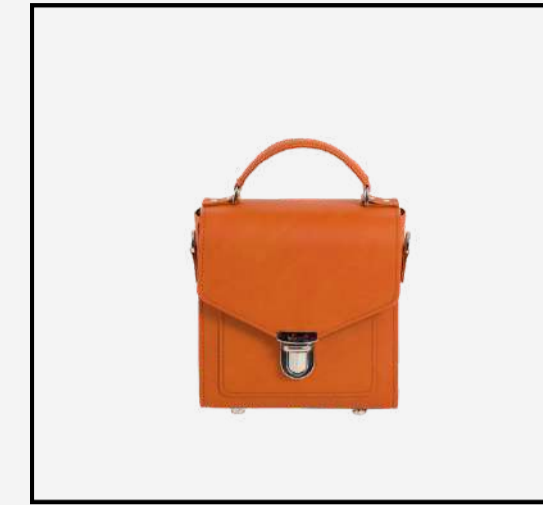
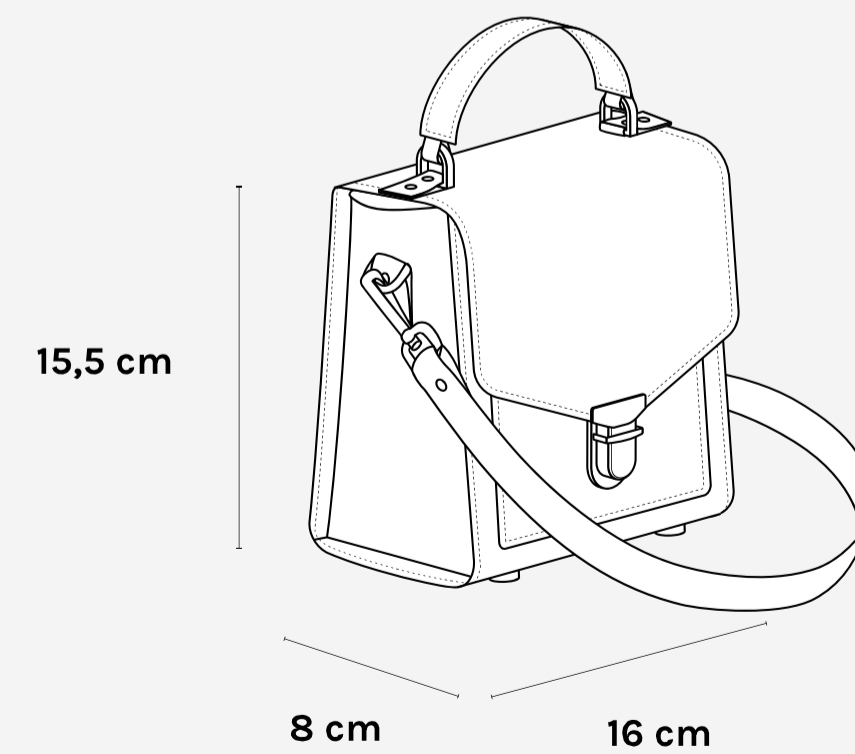

TEJA

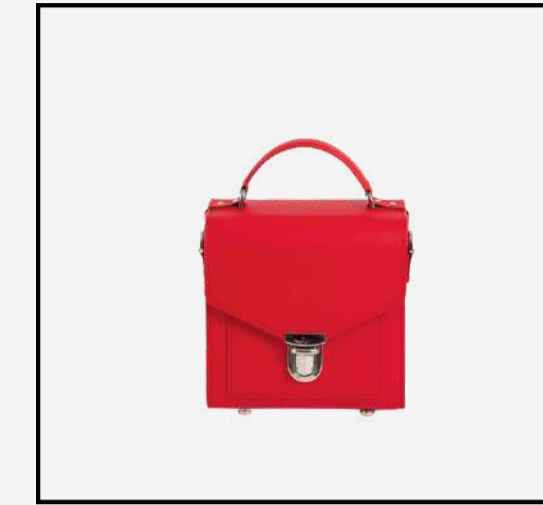

ROJO



NEGRO BOOM



NUDE



CELESTE



VINO



CRUDO



TOSTADO



NAVY

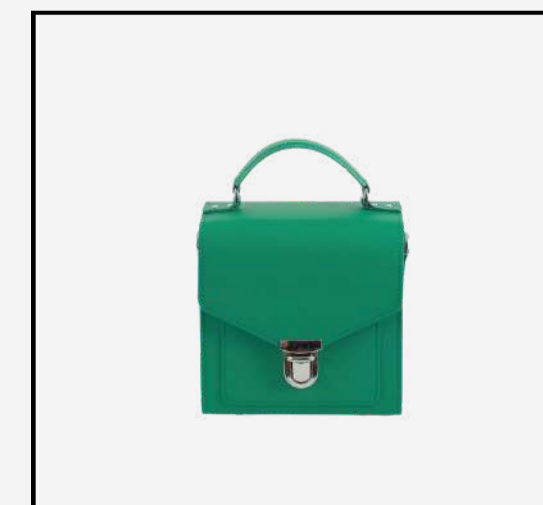

VERDE TRÉBOL



AZUL BIENHECHA



NEGRO MATE



POSICIONES | \*La modelo mide 1,70 m

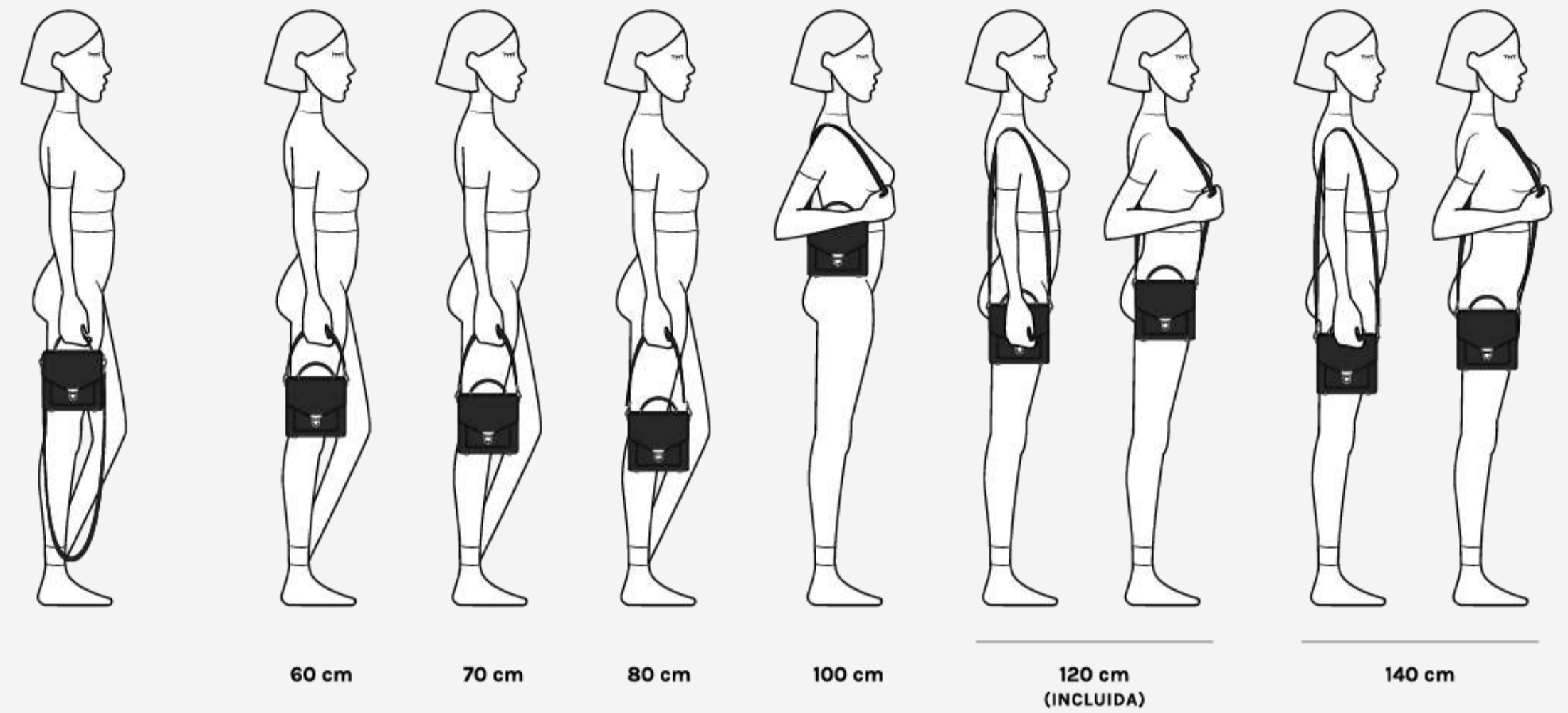

TOP VENTAS

## RAMONA (LA CHICA)

COMPRAR

PVP RETAIL: 299,95€

\*Accede a tu cuenta para ver tu precio wholesale



POSICIONES | \*La modelo mide 1,70 m

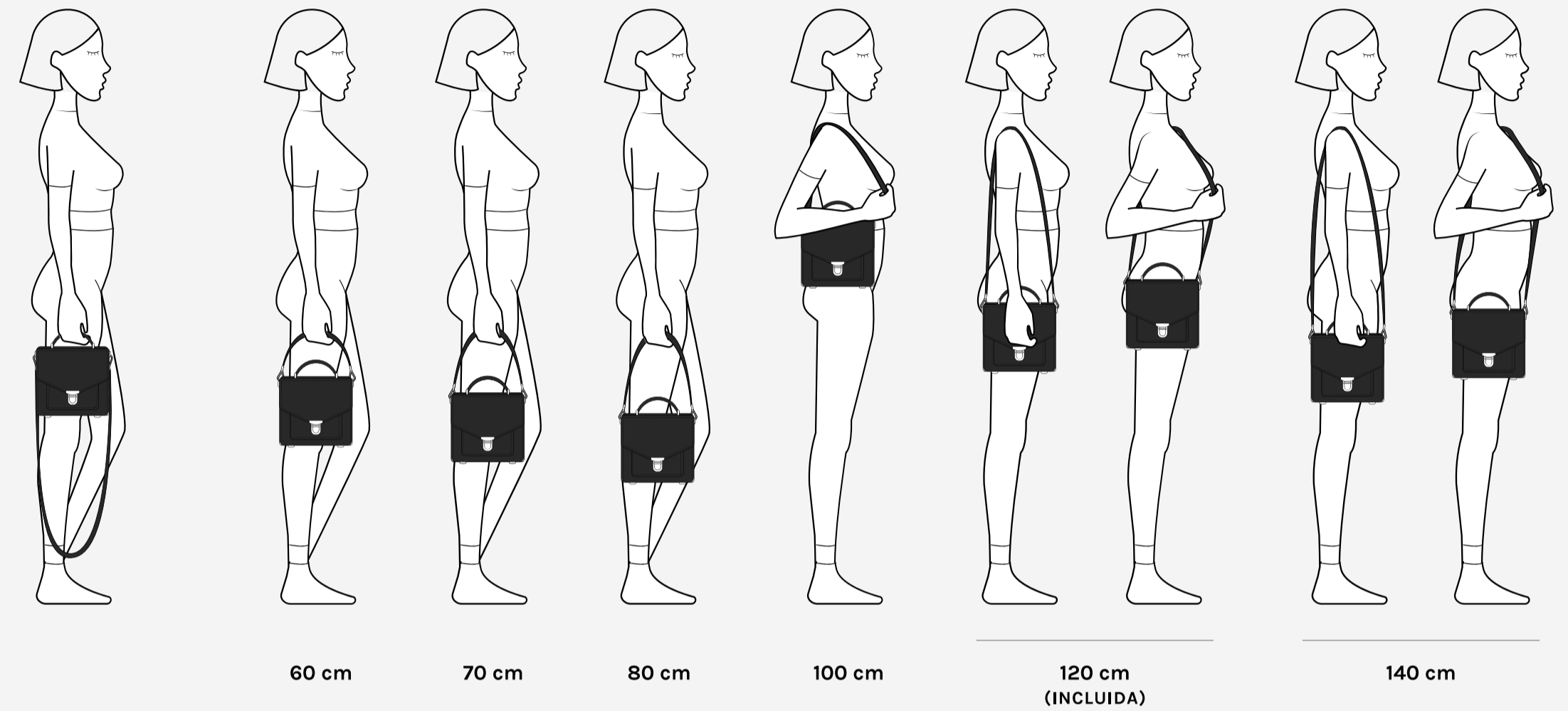

TOP VENTAS

## RAMONA (LA GRANDE)

COMPRAR

PVP RETAIL: 329,95€

\*Accede a tu cuenta para ver tu precio wholesale



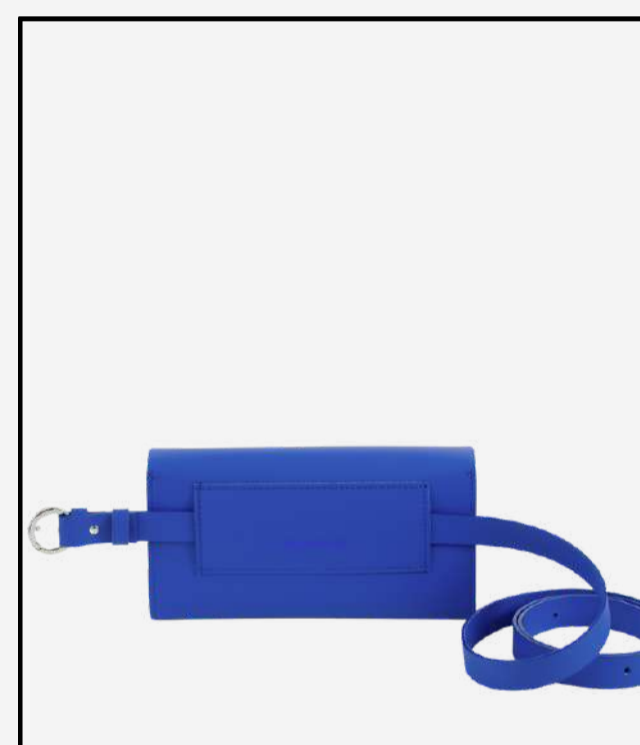
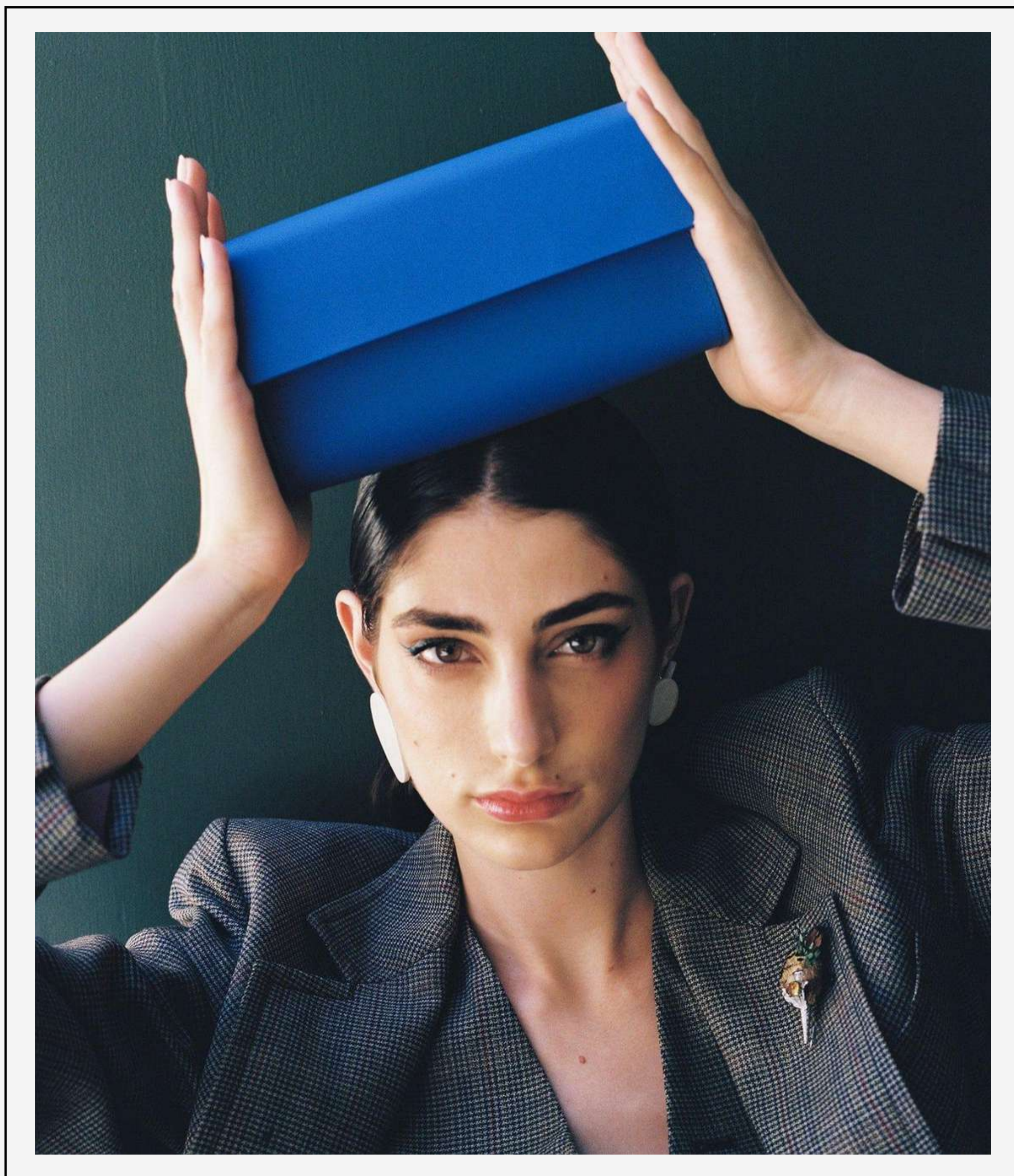

LA RIÑONERA / CLUTCH

## LOLA (LA MAYOR)

Nuestra Lola es uno de los modelos más icónicos. Un bolso 3 en 1 todoterreno. Se puede llevar como clutch, como riñonera (añadiendo el cinturón) o como bandolera.

DESCÚBRELA

LA RIÑONERA / CLUTCH

## LOLA (LA MAYOR)

- Doble cierre de imán con solapa
- Dos bolsillos interiores, uno de ellos tarjetero
- Cantos lujados y pintados a mano para una mayor protección
- Posibilidad de añadir cinturón de 120 cm o de 140 cm
- Accesorios a juego

COMPRAR

EXTRAS

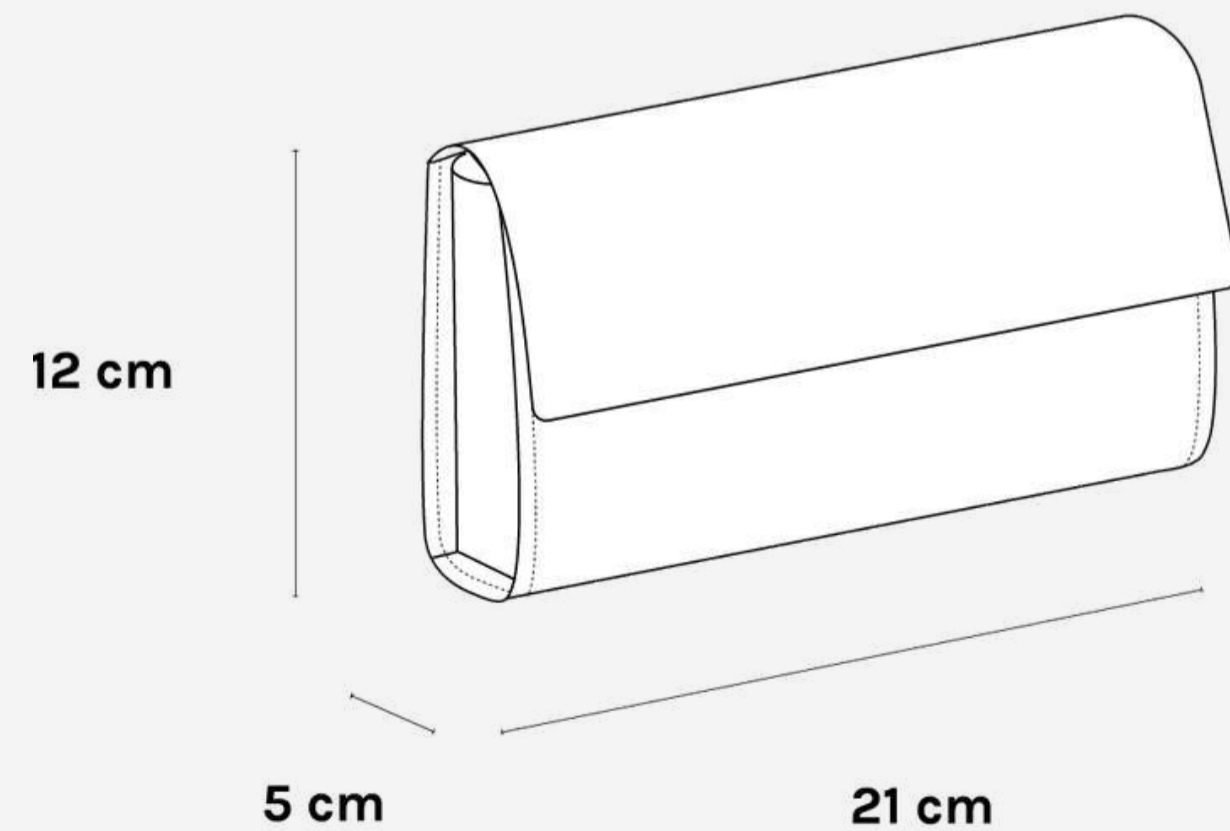

TEJA

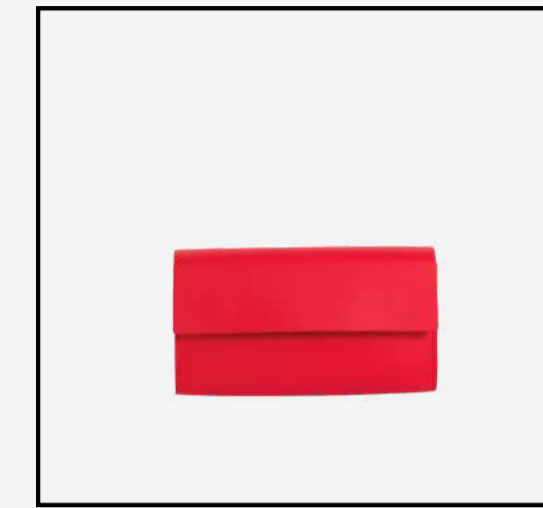

ROJO



NEGRO BOOM

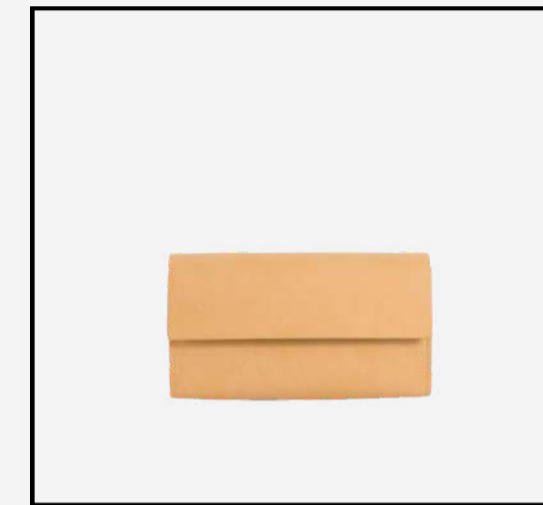

NUDE

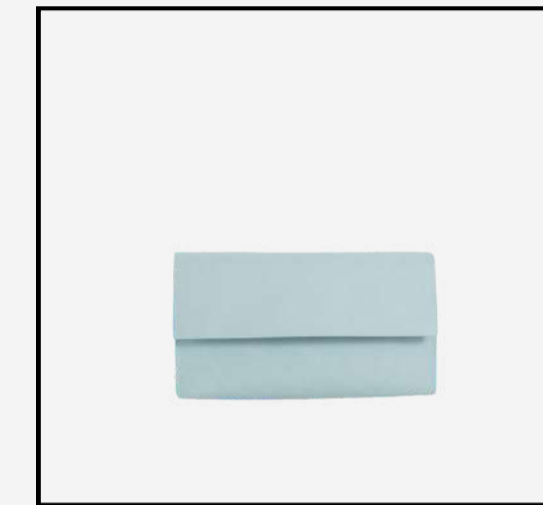

CELESTE



VINO



CRUDO



TOSTADO



NAVY

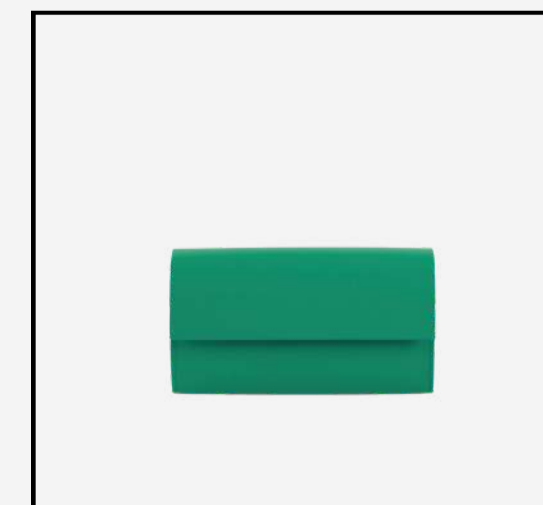

VERDE TRÉBOL

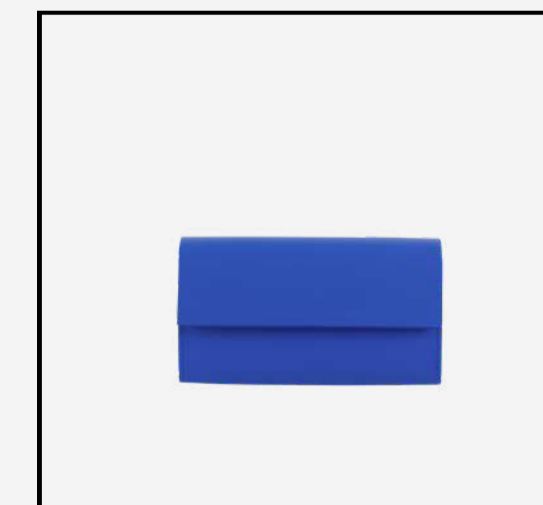

AZUL BIENHECHA



NEGRO MATE



POSICIONES | \*La modelo mide 1,70 m

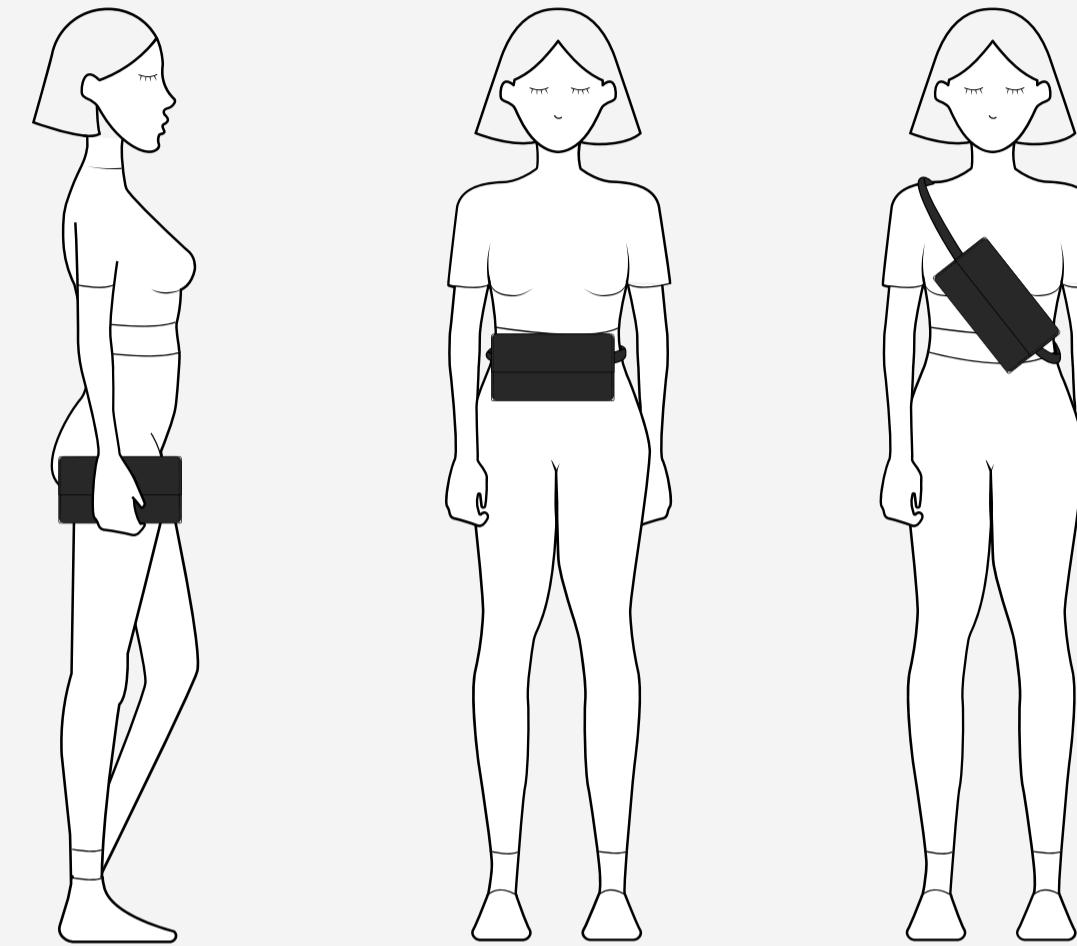

120 cm

140 cm

LA RIÑONERA / CLUTCH

## LOLA (LA MAYOR)

COMPRAR

PVP RETAIL: 159,95€

\*Accede a tu cuenta para ver tu precio wholesale



MINIMALISTA Y ESPACIOSO

## ENCARNITA (LA MAYOR)

De los más minimalistas y puros, pero a la vez superespacioso y cómodo. De tamaño mediano y muy bien estructurado en el cuerpo, con acabados impolutos.

DESCÚBRELA

MINIMALISTA Y ESPACIOSO

## ENCARNITA (LA MAYOR)

- Cierre de imán con solapa
- Un bolsillo interior
- Cantos lujados y pintados a mano para una mayor protección
- Incluye un cordón ajustable de 140 cm
- Cordones extra disponibles: 50 cm, 100 cm, 120 cm o 140 cm
- Accesorios a juego

COMPRAR

EXTRAS

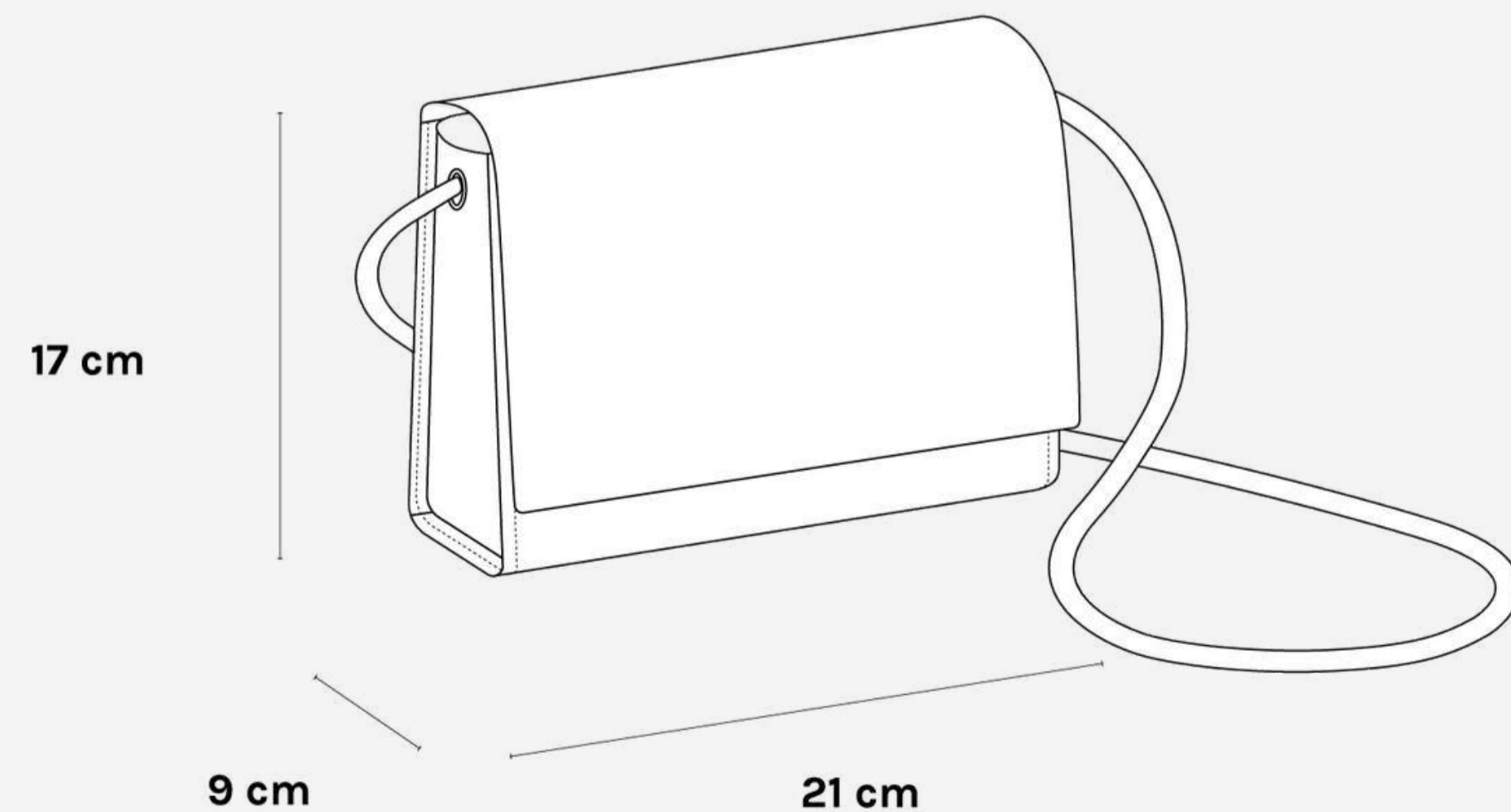

TEJA



ROJO



NEGRO BOOM



NUDE

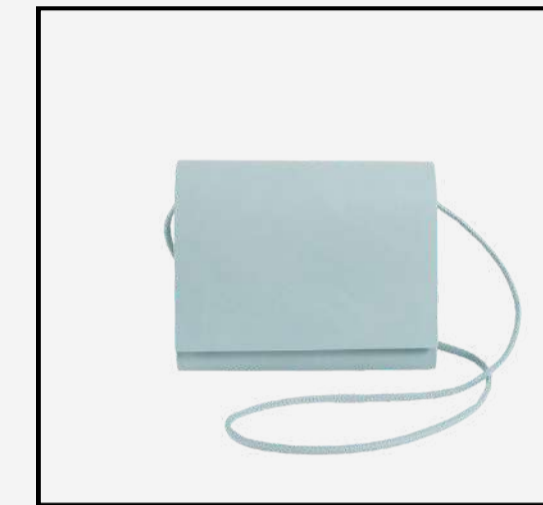

CELESTE



VINO



CRUDO



TOSTADO



NAVY



VERDE TRÉBOL

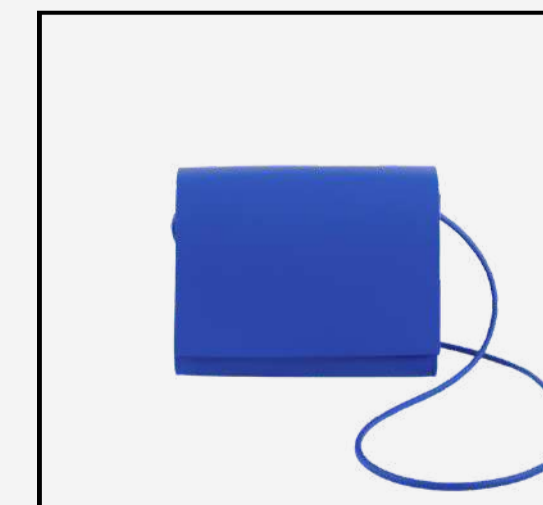

AZUL BIENHECHA



NEGRO MATE



POSICIONES | \*La modelo mide 1,70 m

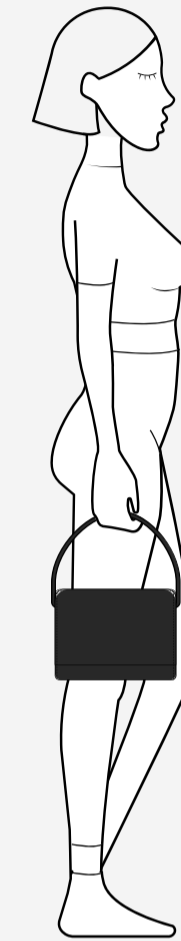

50 cm

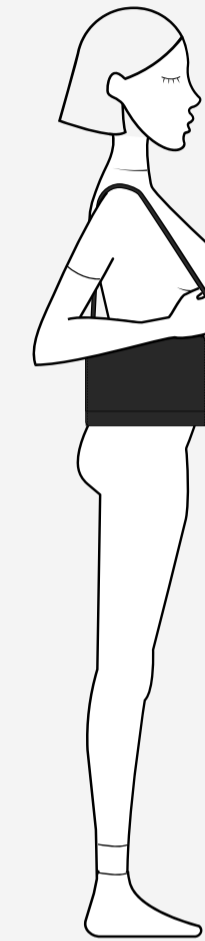

100 cm

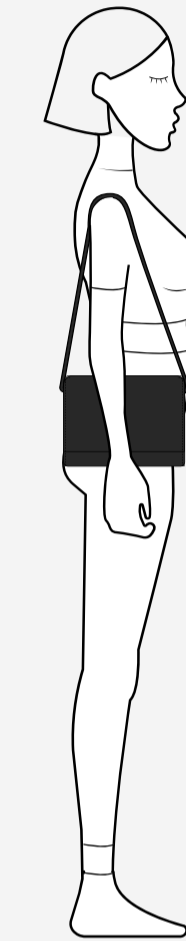

120 cm



140 cm  
(INCLUIDO)

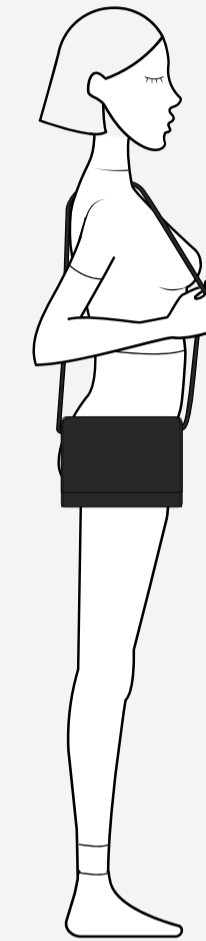

MINIMALISTA Y ESPACIOSO

## ENCARNITA (LA MAYOR)

COMPRAR

PVP RETAIL: 169,95€

\*Accede a tu cuenta para ver tu precio wholesale

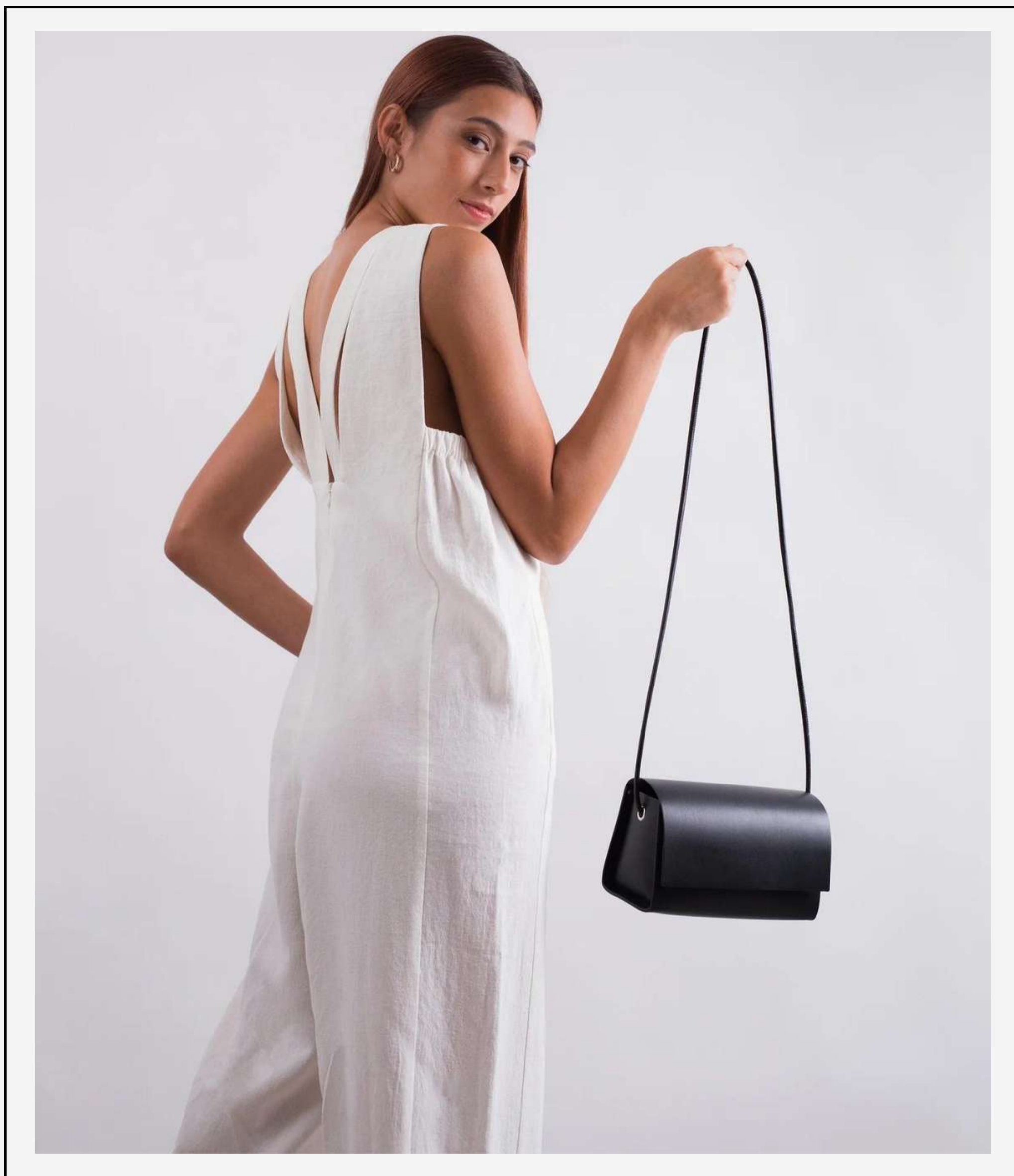

SUPERESPACIOSO

## AMPARITO (LA MAYOR)

Un bolso versátil, espacioso y con el tamaño ideal. Te sorprenderá muchísimo la capacidad de Amparito y la comodidad de tenerlo todo a mano gracias a su anchura.

DESCÚBRELA

SUPERESPACIOSO

## AMPARITO (LA MAYOR)

- Cierre de imán con solapa
- Un bolsillo interior
- Cantos lujados y pintados a mano para una mayor protección
- Incluye un cordón ajustable de 140 cm
- Cordones extra disponibles: 50 cm, 100 cm, 120 cm o 140 cm
- Accesorios a juego

COMPRAR

EXTRAS

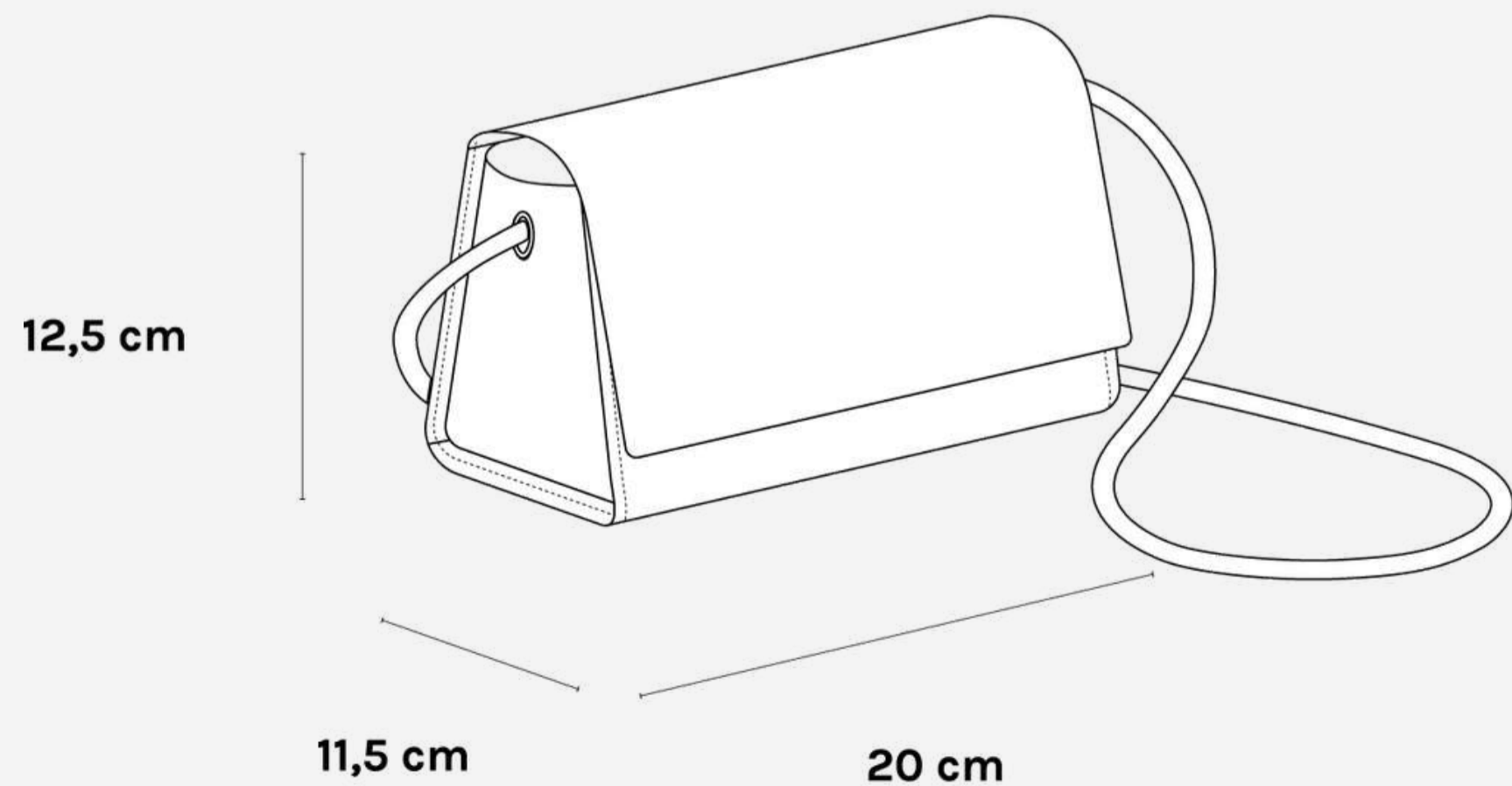

TEJA



ROJO



NEGRO BOOM



NUDE

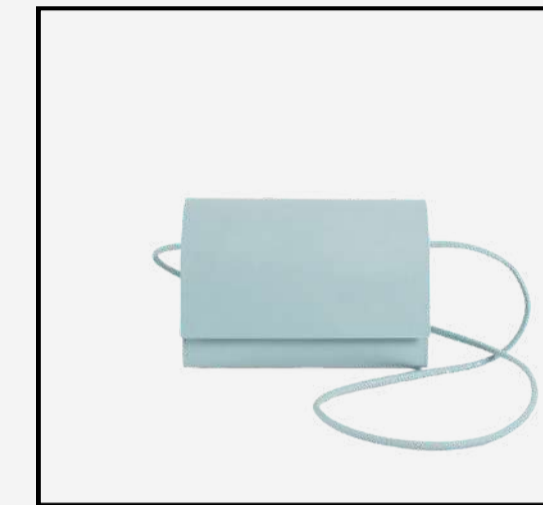

CELESTE



VINO



CRUDO



TOSTADO



NAVY

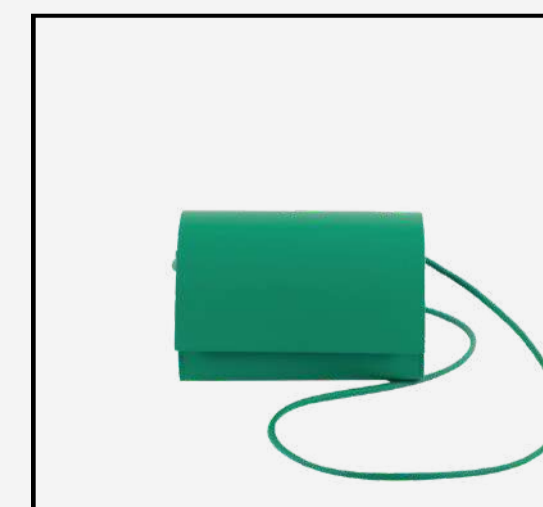

VERDE TRÉBOL



AZUL BIENHECHA



NEGRO MATE





POSICIONES | \*La modelo mide 1,70 m

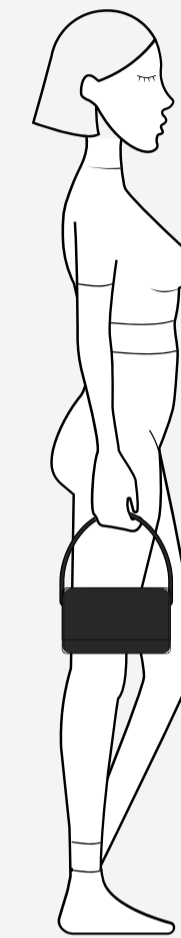

50 cm

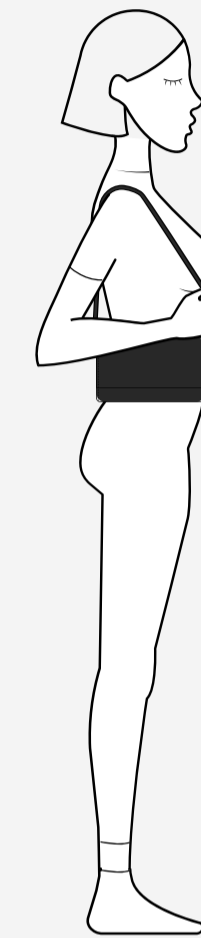

100 cm

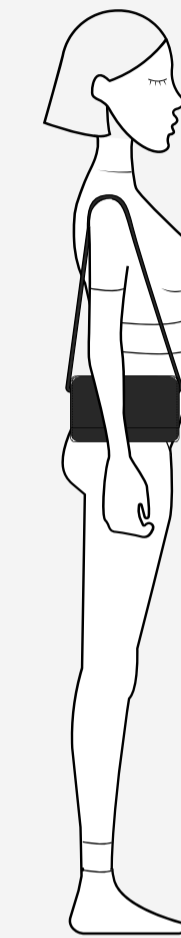

120 cm

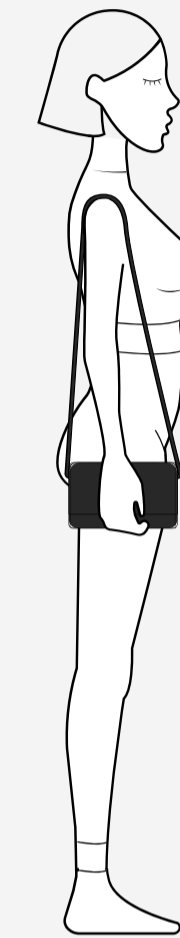

140 cm  
(INCLUIDO)

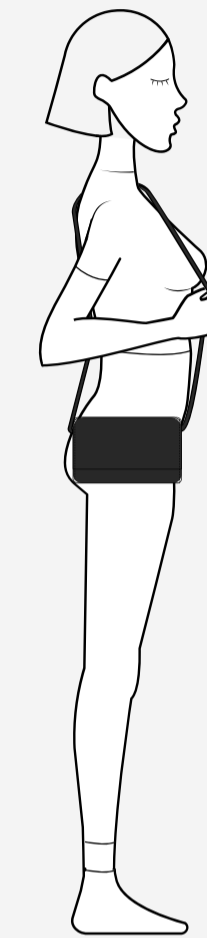

SUPERESPACIOSO

## AMPARITO (LA MAYOR)

COMPRAR

PVP RETAIL: 164,95€

\*Accede a tu cuenta para ver tu precio wholesale

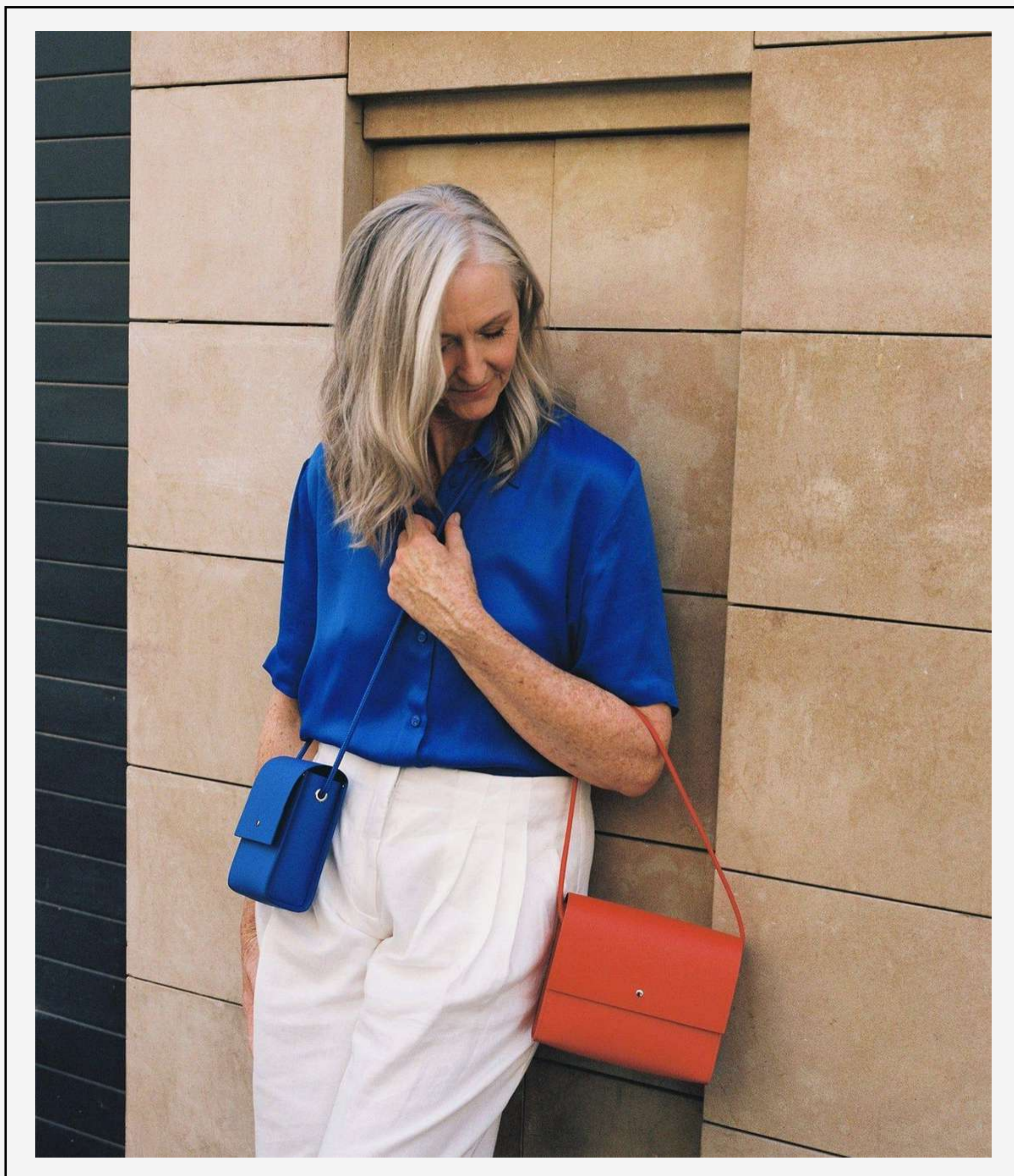

BÁSICOS

## CARMEN

Un bolso superligero pero con mucho espacio. Es el de mayor tamaño de la familia de tres (Carmelita, Carmela y Carmen). Básicos, pero no tanto.

DESCÚBRELA

## BÁSICOS

# CARMEN

- Cierre de imán con solapa
- Un bolsillo interior
- Cantos lujados y pintados a mano para una mayor protección
- Incluye un cordón ajustable de 140 cm
- Cordones extra disponibles: 50 cm, 100 cm, 120 cm o 140 cm
- Accesorios a juego

COMPRAR

EXTRAS

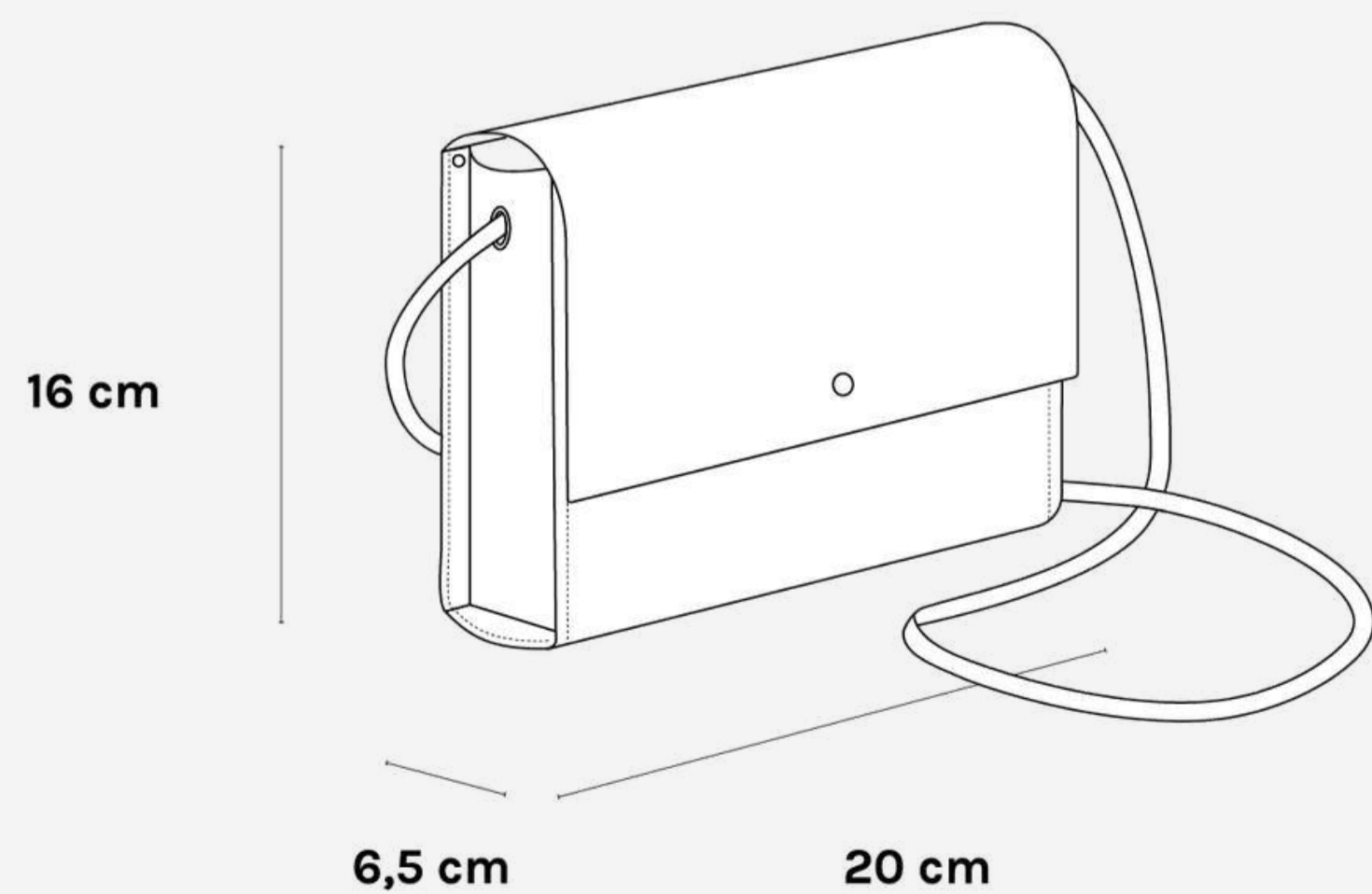

TEJA



ROJO



NEGRO BOOM



NUDE



CELESTE



VINO



CRUDO



TOSTADO



NAVY



VERDE TRÉBOL



AZUL BIENHECHA



NEGRO MATE



POSICIONES | \*La modelo mide 1,70 m

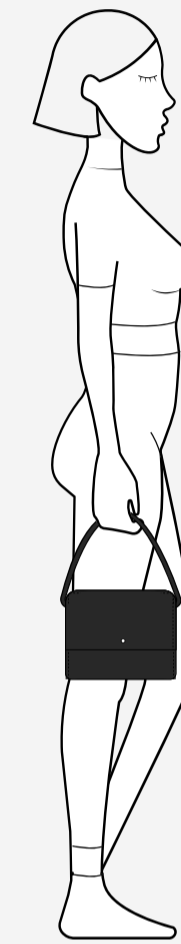

50 cm

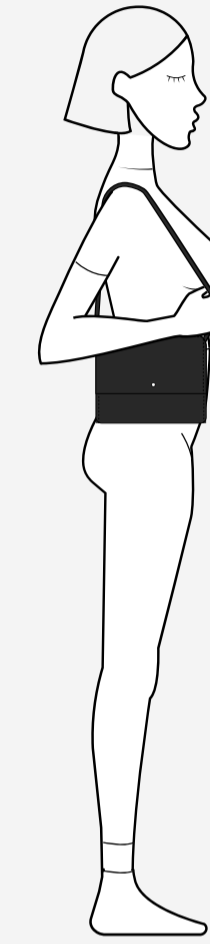

100 cm



120 cm

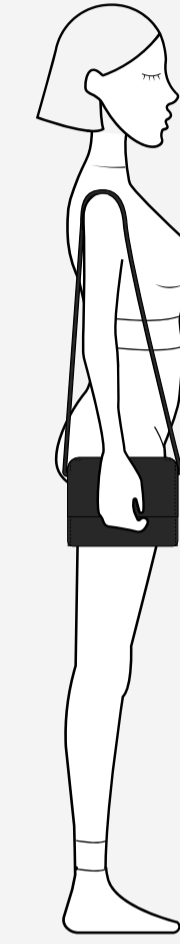

140 cm  
(INCLUIDO)

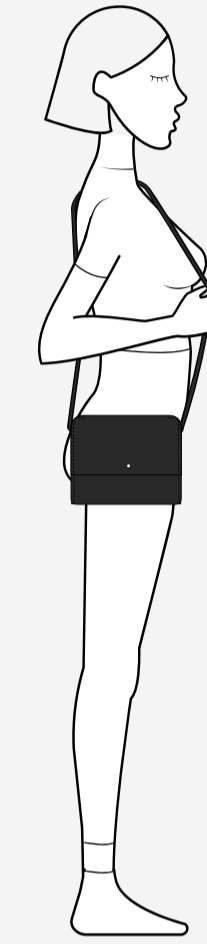

BÁSICOS

**CARMEN**

COMPRAR

PVP RETAIL: 159,95€

\*Accede a tu cuenta para ver tu precio wholesale



BÁSICOS

## CARMELA

Es el mediano de la familia de tres (Carmelita, Carmela y Carmen). Básico pero especial, ligero, con suficiente espacio para los esenciales y suuuuuper versátil.

DESCÚBRELA

## BÁSICOS

# CARMELA

- Cierre de imán con solapa
- Un bolsillo interior
- Cantos lujados y pintados a mano para una mayor protección
- Incluye un cordón ajustable de 140 cm
- Cordones extra disponibles: 50 cm, 100 cm, 120 cm o 140 cm
- Accesorios a juego

COMPRAR

EXTRAS

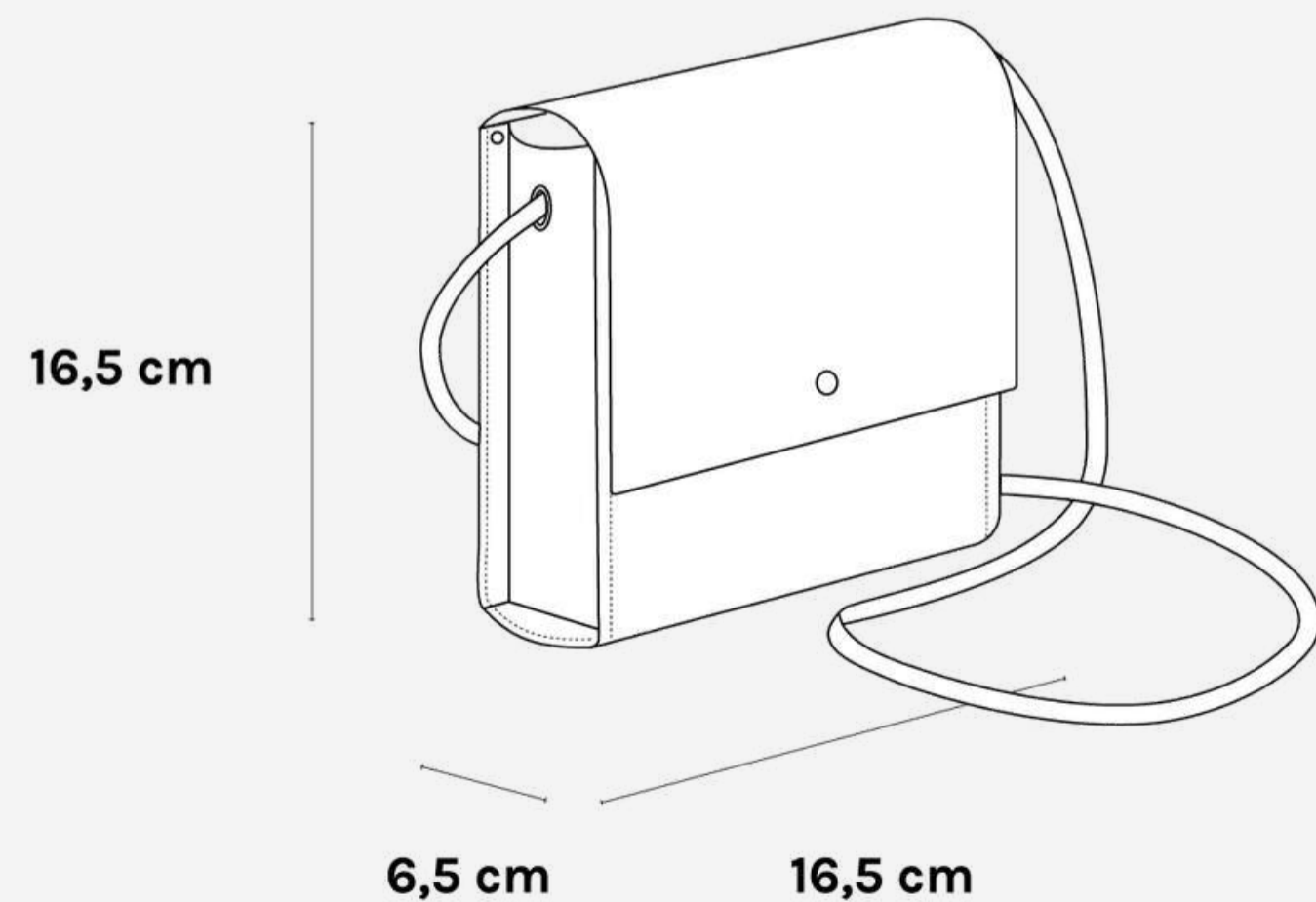

TEJA



ROJO



NEGRO BOOM



NUDE



CELESTE



VINO



CRUDO



TOSTADO

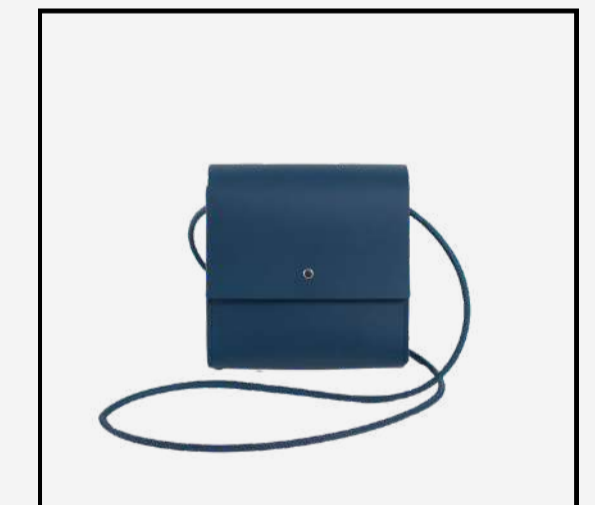

NAVY



VERDE TRÉBOL



AZUL BIENHECHA



NEGRO MATE



POSICIONES | \*La modelo mide 1,70 m

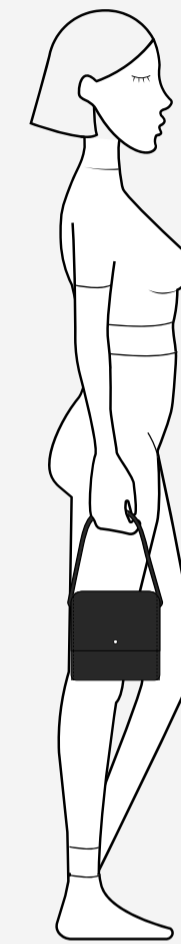

50 cm

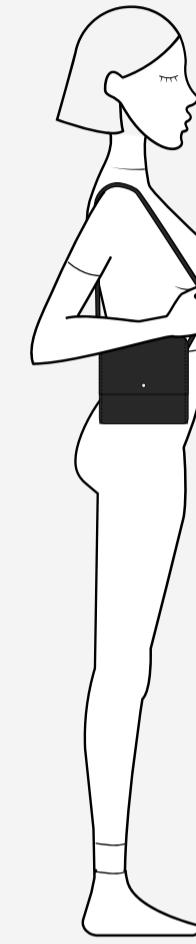

100 cm



120 cm

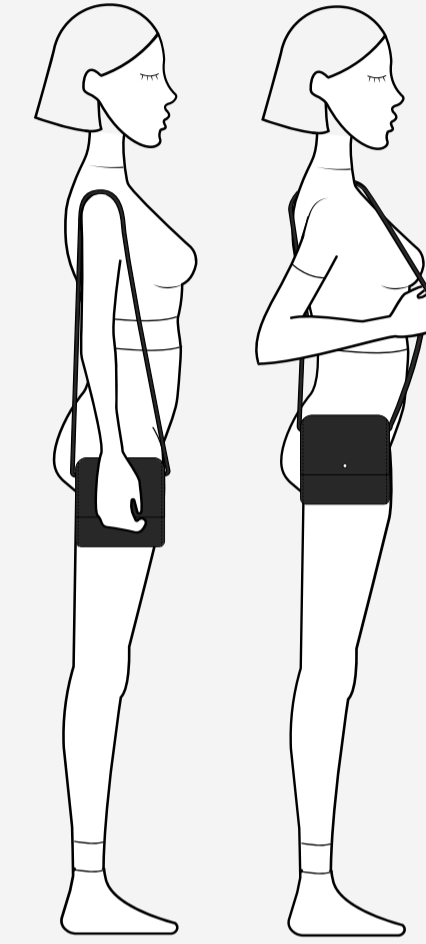

140 cm  
(INCLUIDO)

BÁSICOS

## CARMELA

COMPRAR

PVP RETAIL: 154,95€

\*Accede a tu cuenta para ver tu precio wholesale

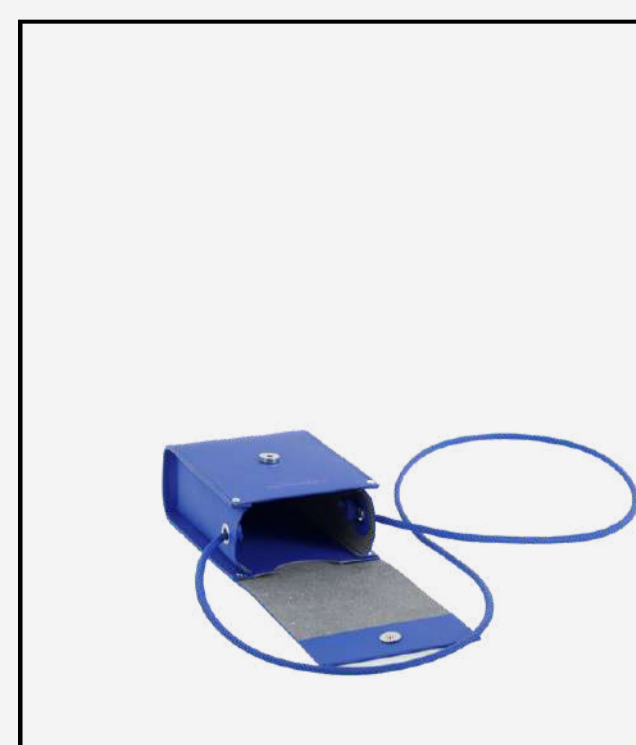
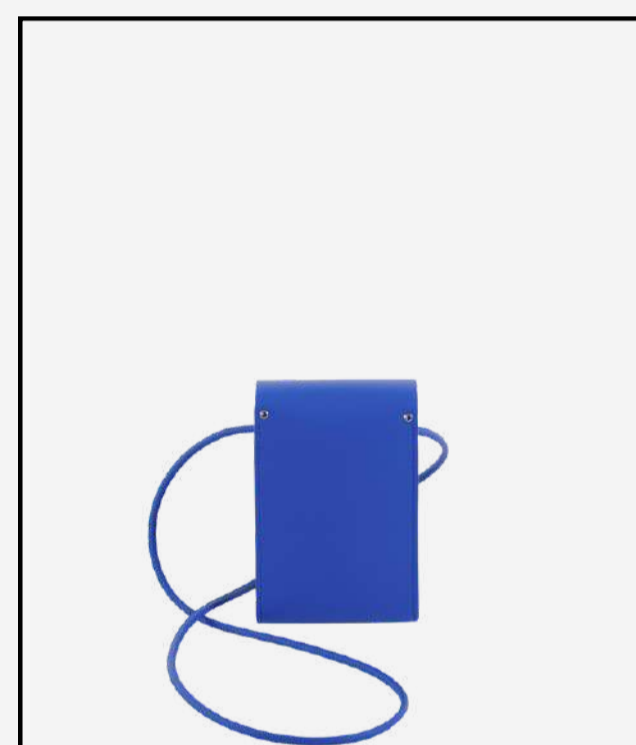

BÁSICOS

## CARMELITA

El más pequeño de la familia de tres (Carmelita, Carmela y Carmen) pero con muchísima personalidad. No pesa nada de nada. Es elegante, sencillo y realmente práctico.

DESCÚBRELA



## BÁSICOS

# CARMELITA

- Cierre de imán con solapa
- Un bolsillo interior
- Cantos lujados y pintados a mano para una mayor protección
- Incluye un cordón ajustable de 140 cm
- Cordones extra disponibles: 60 cm, 70 cm, 80 cm, 100 cm, 120 cm o 140 cm
- Accesorios a juego

COMPRAR

EXTRAS

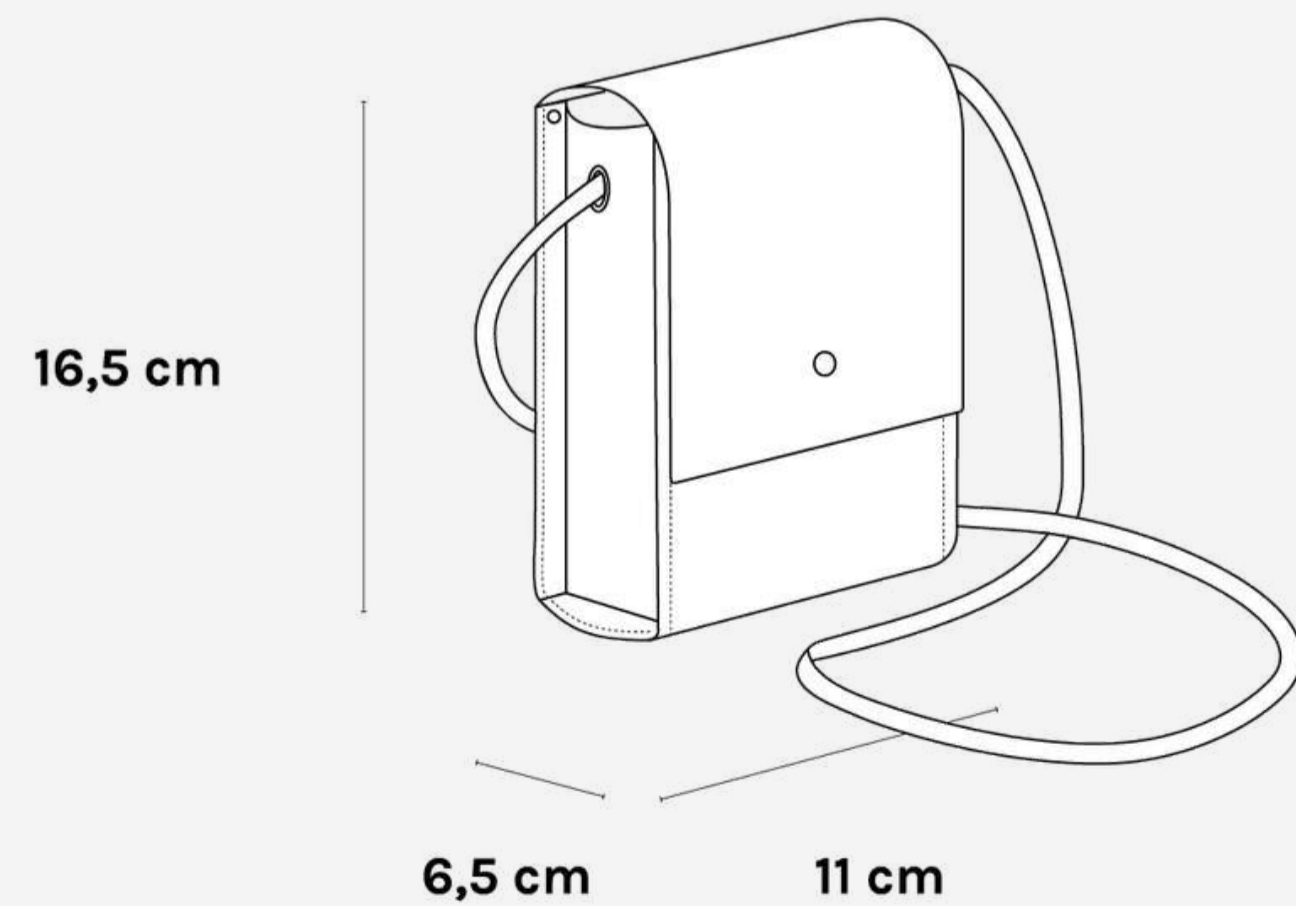

TEJA



ROJO



NEGRO BOOM



NUDE

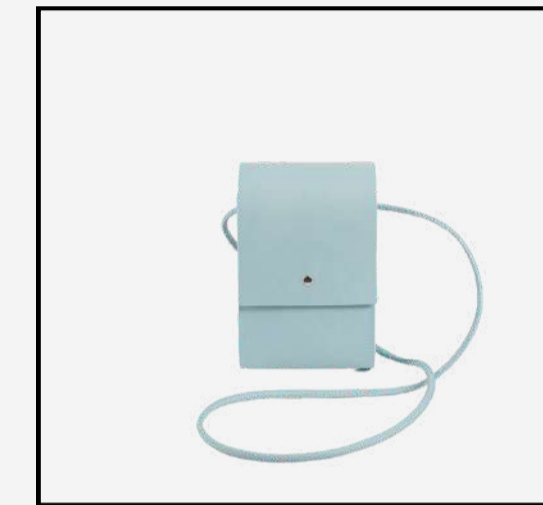

CELESTE



VINO



CRUDO



TOSTADO



NAVY



VERDE TRÉBOL

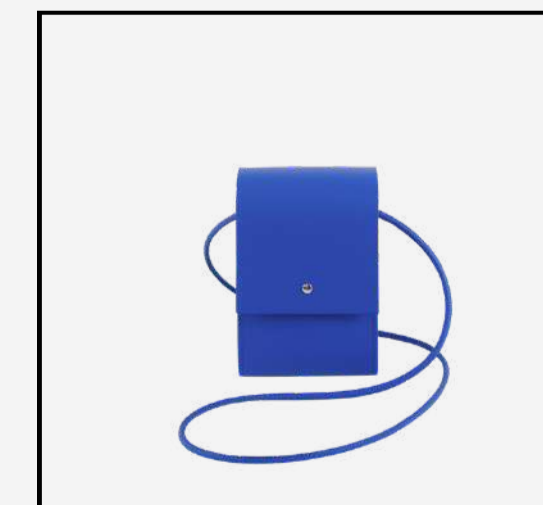

AZUL BIENHECHA



NEGRO MATE



POSICIONES | \*La modelo mide 1,70 m



50 cm

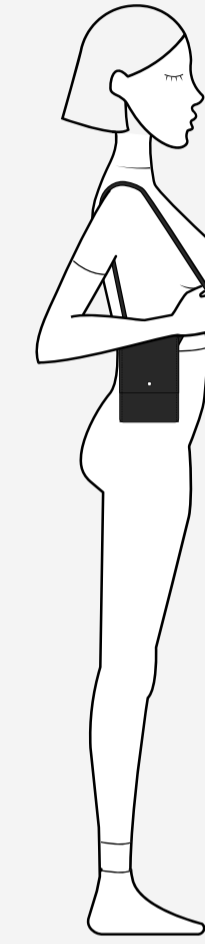

100 cm



120 cm

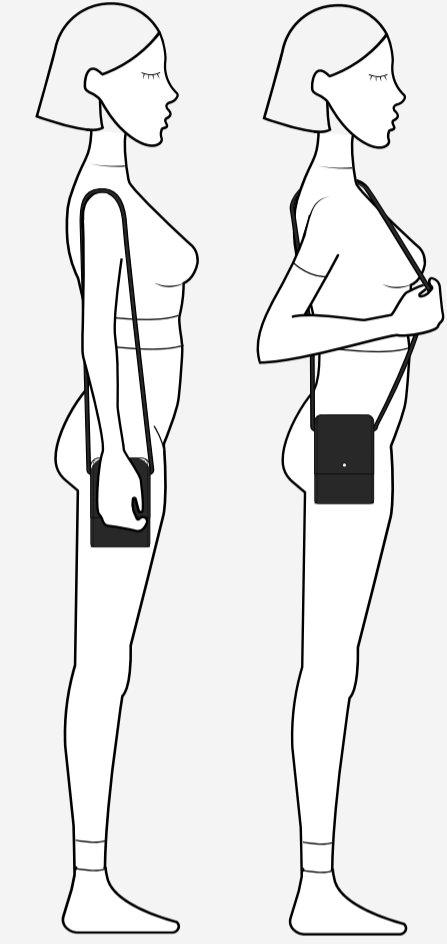

140 cm  
(INCLUIDO)

BÁSICOS

## CARMELITA

COMPRAR

PVP RETAIL: 149,95€

\*Accede a tu cuenta para ver tu precio wholesale



CUERO RECICLADO

## ACCESORIOS

Nuestros accesorios son la opción perfecta para combinar con nuestros bolsos o para usarlos de forma independiente.

DESCÚBRELOS

## ACCESORIOS

# ROSARITO

- Cierre de cremallera
- Cantos lujados y pintados a mano para una mayor protección
- Perfecta como monedero o para guardar tarjetas, tickets, o cualquier cosa que se quiera tener separada dentro del bolso
- Pack perfecto si se acompaña de Rosario

COMPRAR

PVP RETAIL: 49,95€

\*Accede a tu cuenta para ver tu precio wholesale

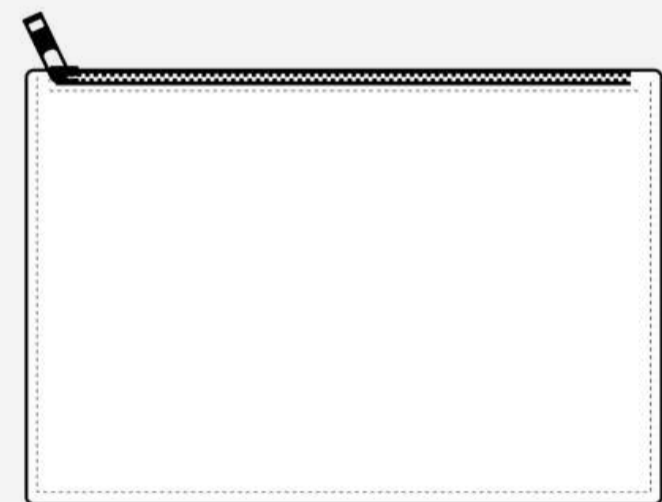

10,5 cm

15 cm



TEJA



ROJO



NEGRO BOOM



NUDE



CELESTE



VINO



CRUDO



TOSTADO



NAVY



VERDE TRÉBOL



AZUL BIENHECHA



NEGRO MATE

## ACCESORIOS

# ROSARIO

- Cierre de cremallera
- Cantos lujados y pintados a mano para una mayor protección
- Perfecta como monedero o para guardar tarjetas, tickets, o cualquier cosa que se quiera tener separada dentro del bolso
- Pack perfecto si se acompaña de Rosarito

COMPRAR

PVP RETAIL: 54,95€

\*Accede a tu cuenta para ver tu precio wholesale

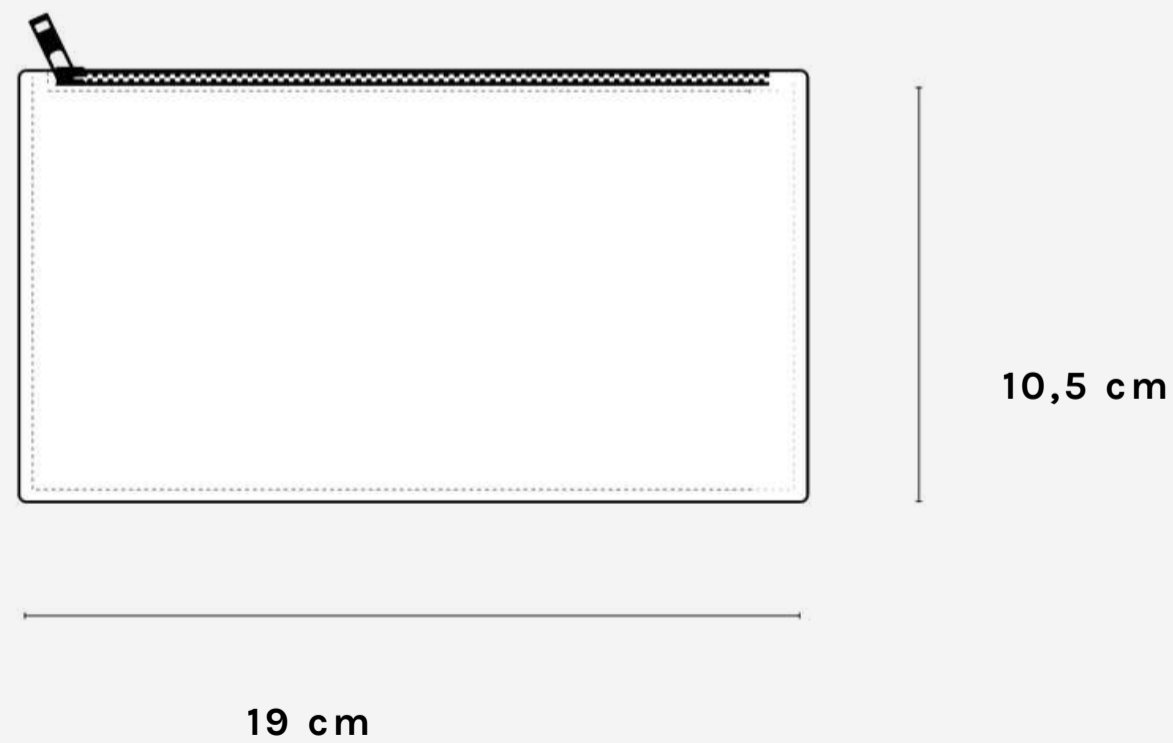

TEJA



ROJO



NEGRO BOOM



NUDE



CELESTE



VINO



CRUDO



TOSTADO



NAVY



VERDE TRÉBOL



AZUL BIENHECHA



NEGRO MATE

## ACCESORIOS

# OLIVIA

- Doble tarjetero (máximo 6 tarjetas)
- Cantos lujados y pintados a mano para una mayor protección
- Perfecta para guardar tarjetas, tickets, bonos transporte

COMPRAR

PVP RETAIL: 39,95€

\*Accede a tu cuenta para ver tu precio wholesale

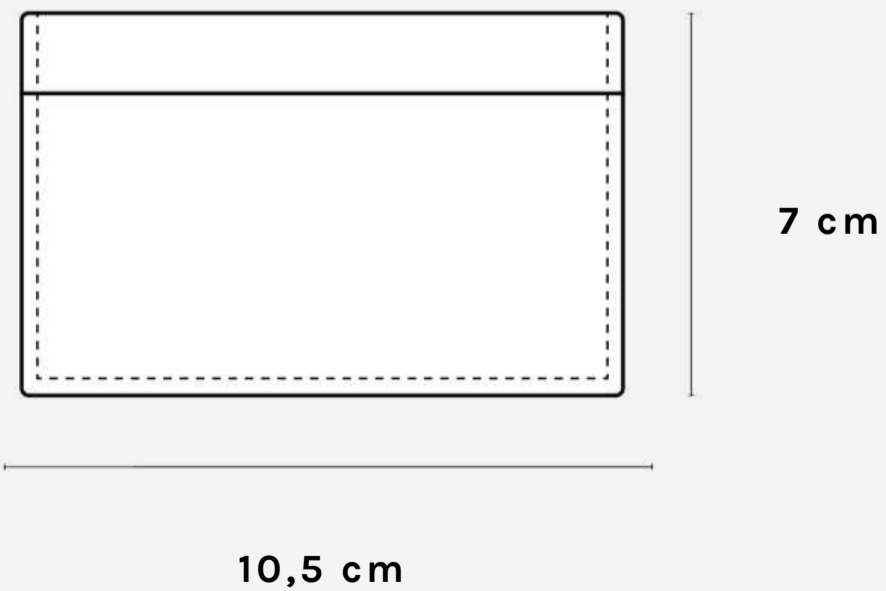

TEJA



ROJO

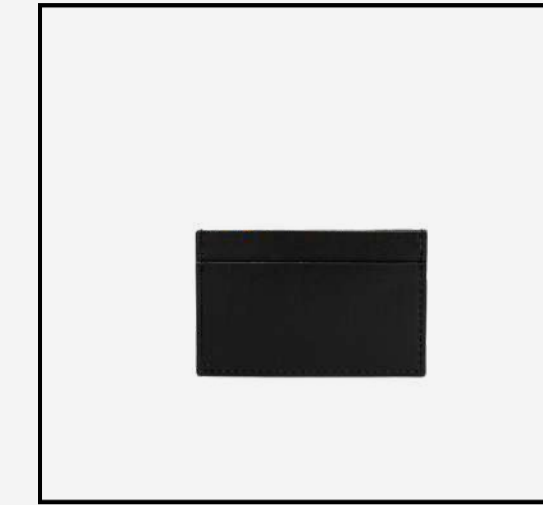

NEGRO BOOM



NUDE



CELESTE

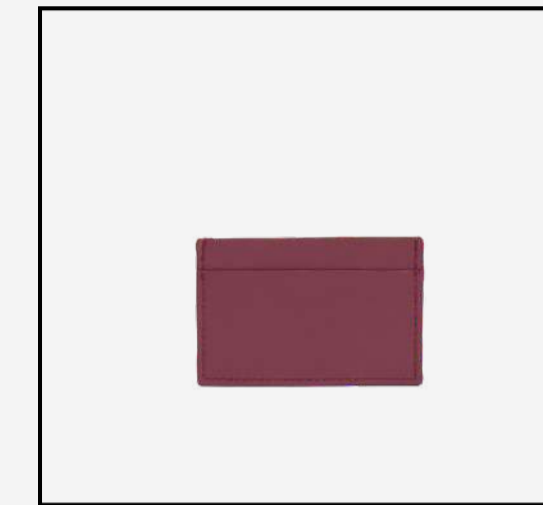

VINO

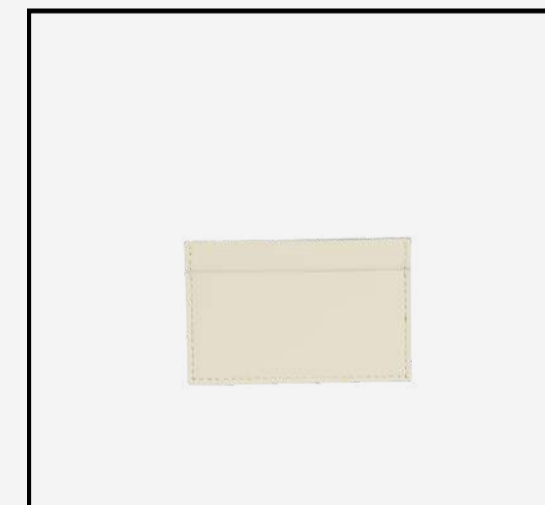

CRUDO



TOSTADO



NAVY

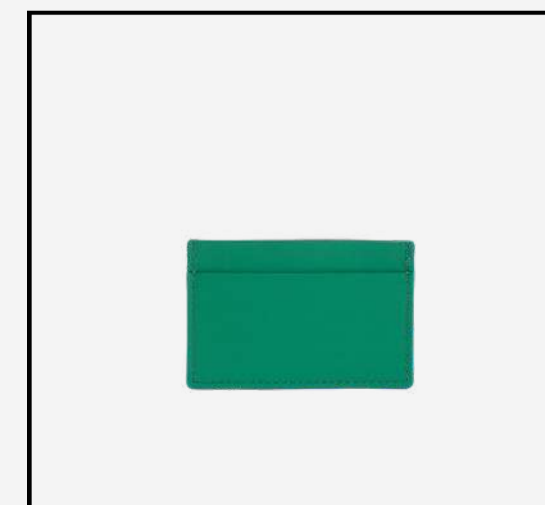

VERDE TRÉBOL

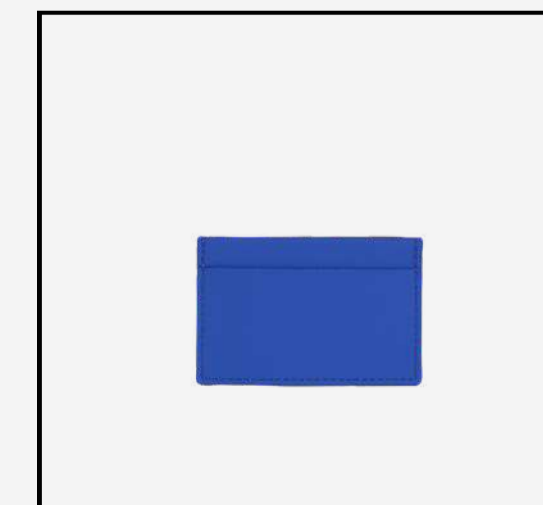

AZUL BIENHECHA



NEGRO MATE



CUERO RECICLADO

## EXTRAS

Para darle vida a nuestros bienhechas. Añade correas y cordones para intercambiar y mezclar colores, y hacer varios bolsos en uno.

DESCÚBRELOS

EXTRAS

## PASAHOMBROS

- Pequeño: 2,5 cm x 12,5 cm - Para Paca y Paquita
- Grande: 4 cm x 18 cm - Bernardita, Bernarda, Carmen, Carmela, Carmelita, Amparito (La Mayor) y Encarnita (La Mayor)

COMPRAR

PVP RETAIL: 24,95€

\*Accede a tu cuenta para ver tu precio wholesale

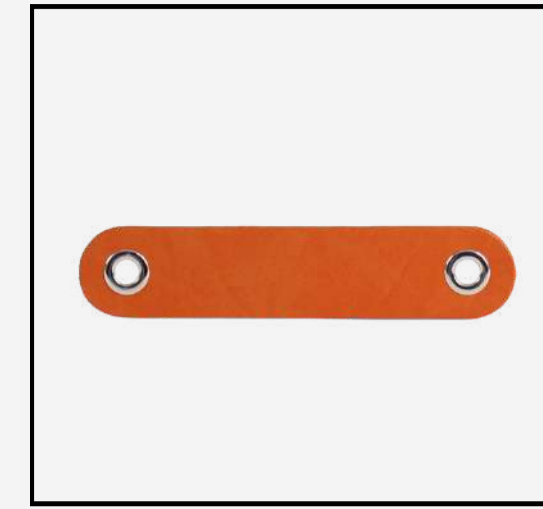

TEJA

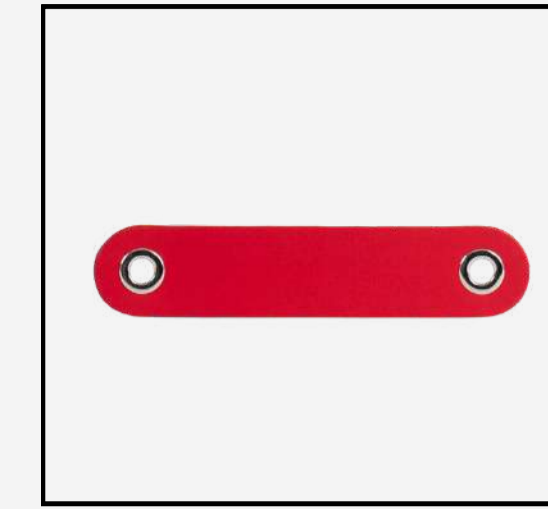

ROJO

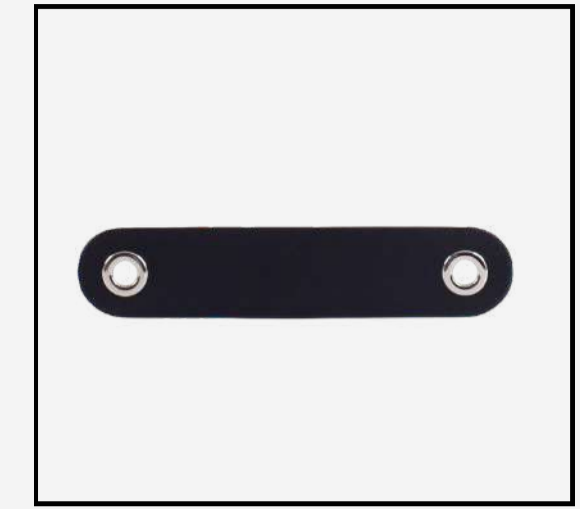

NEGRO BOOM

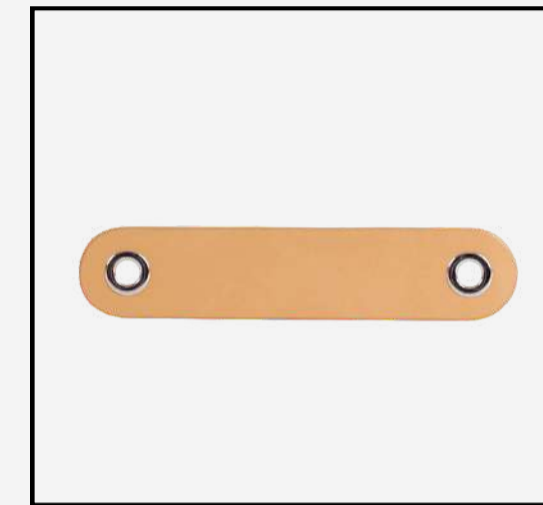

NUDE

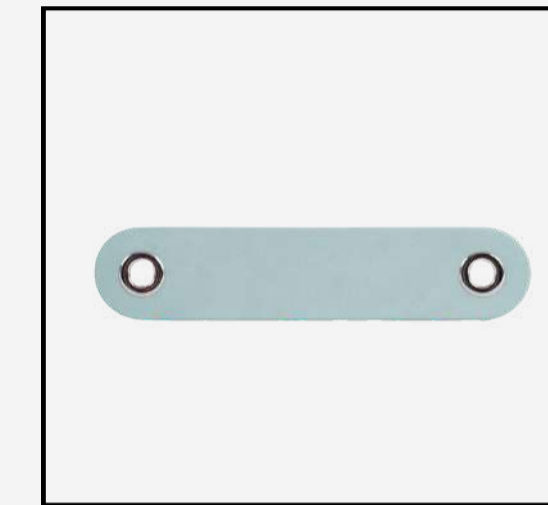

CELESTE

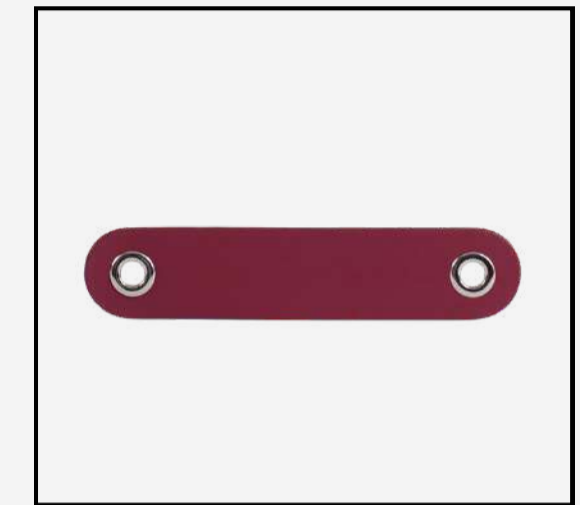

VINO



CRUDO

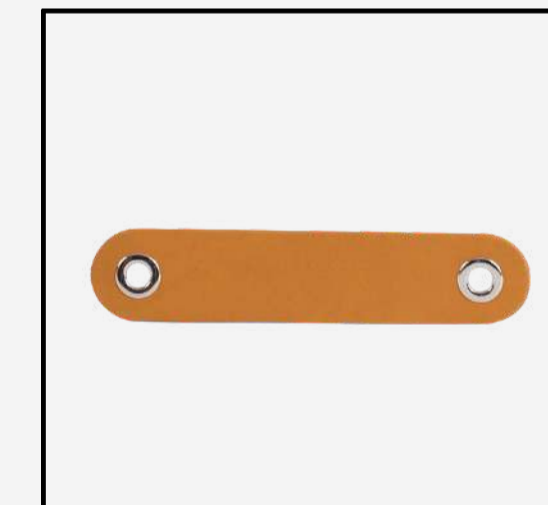

TOSTADO



NAVY

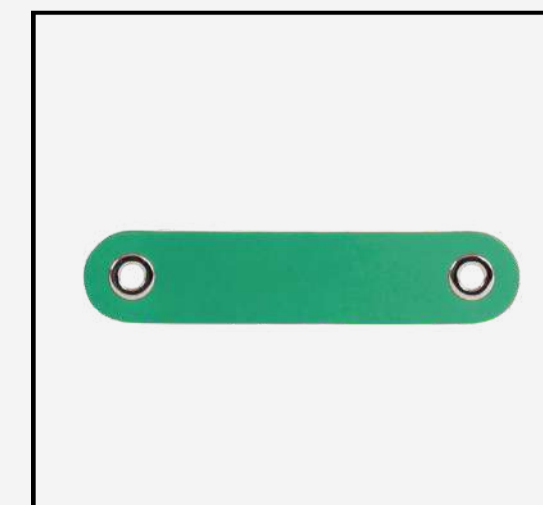

VERDE TRÉBOL

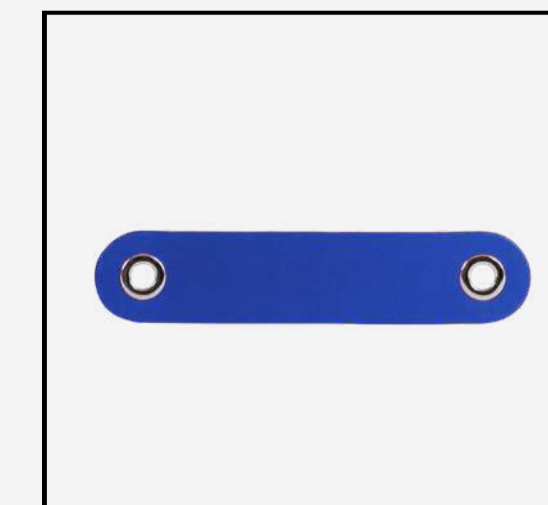

AZUL BIENHECHA



NEGRO MATE



EXTRAS

## CORDONES

- Medidas ajustables disponibles: 50 cm, 100 cm, 120 cm, 140 cm.
- Mini: 0,4 diámetro - Para Paca y Paquita
- Maxi: 0,6 diámetro - Para Bernardita, Bernarda, Carmen, Carmela, Carmelita, Amparito (La Mayor) y Encarnita (La Mayor)

COMPRAR

PVP RETAIL: 15,95€

\*Accede a tu cuenta para ver tu precio wholesale

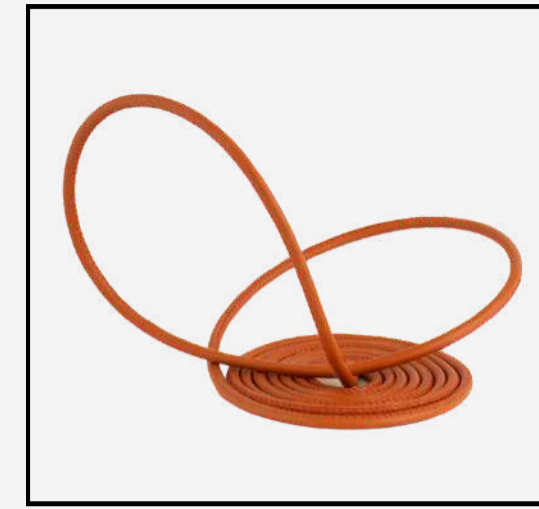

TEJA



ROJO



NEGRO BOOM



NUDE

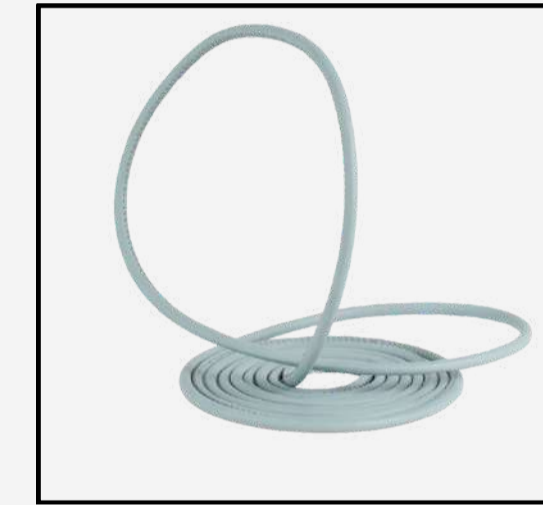

CELESTE



VINO



CRUDO



TOSTADO



NAVY



VERDE TRÉBOL



AZUL BIENHECHA



NEGRO MATE

EXTRAS

## CINTURONES

- Medidas disponibles: 120 cm y 140 cm
- Cantos lujados, pintados y ajustables
- Compatible con Lola (La Mayor)

COMPRAR

PVP RETAIL: 59,95€

\*Accede a tu cuenta para ver tu precio wholesale



TEJA



ROJO



NEGRO BOOM



NUDE



CELESTE



VINO



CRUDO



TOSTADO



NAVY



VERDE TRÉBOL



AZUL BIENHECHA



NEGRO MATE

EXTRAS

## CORREAS

- Medidas disponibles: 60 cm, 70 cm, 80 cm, 100 cm, 120 cm y 140 cm
- Cantos lujados y pintados
- Ajustables
- Compatible con Sofía Madre, Sofía Hija, Josefa, Pepa

COMPRAR

PVP RETAIL: 34,95€

\*Accede a tu cuenta para ver tu precio wholesale

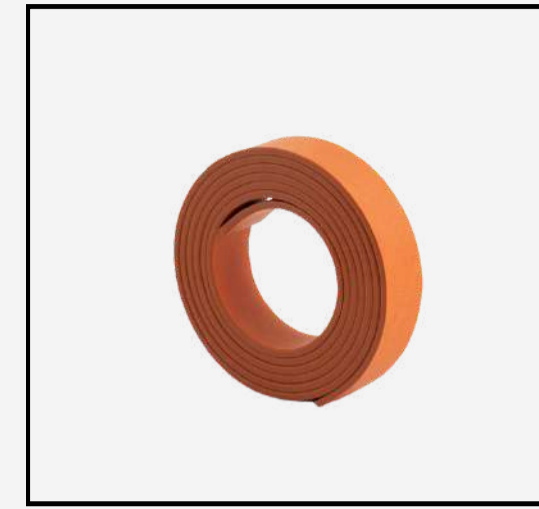

TEJA



ROJO



NEGRO BOOM

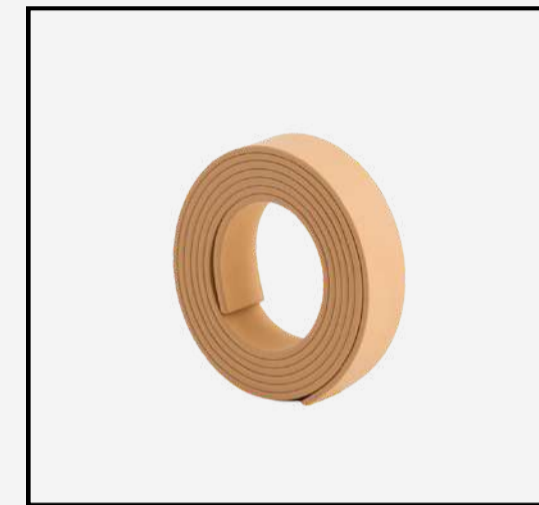

NUDE

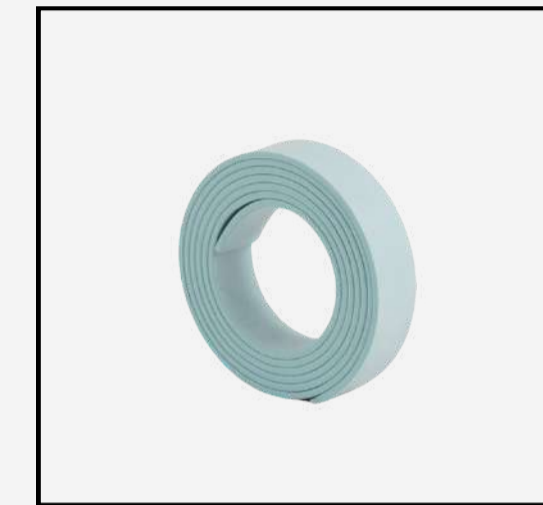

CELESTE



VINO



CRUDO



TOSTADO



NAVY



VERDE TRÉBOL

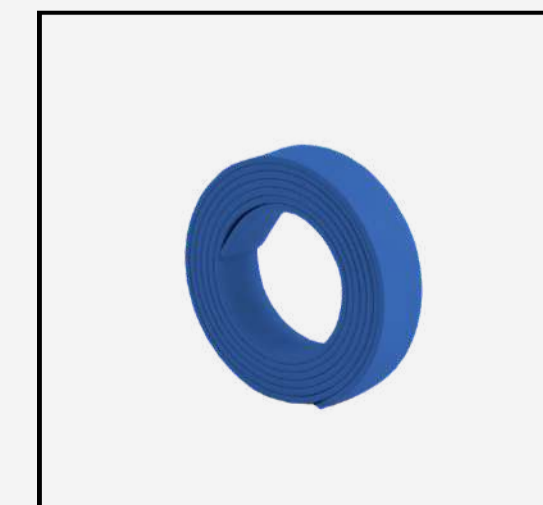

AZUL BIENHECHA



NEGRO MATE

EXTRAS

## CORREAS MOSQUETÓN

- Medidas disponibles: 60 cm, 70 cm, 100 cm, 120 cm y 140 cm
- Cantos lujados y pintados
- Ajustables
- Compatible con Ramonas

COMPRAR

PVP RETAIL: 39,95€

\*Accede a tu cuenta para ver tu precio wholesale



TEJA



ROJO



NEGRO BOOM

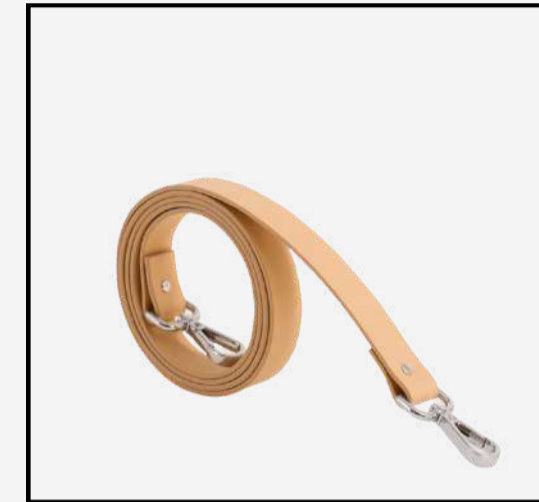

NUDE

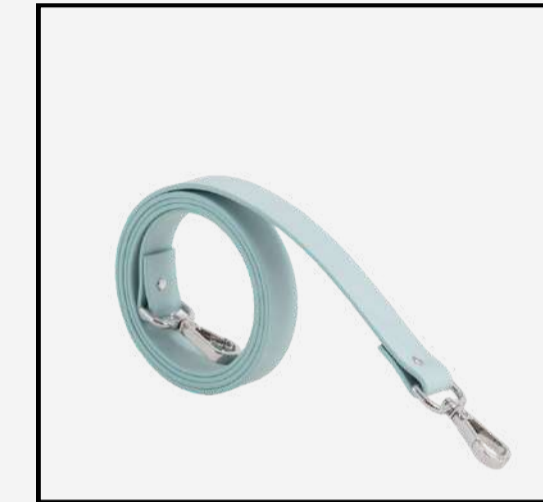

CELESTE



VINO



CRUDO

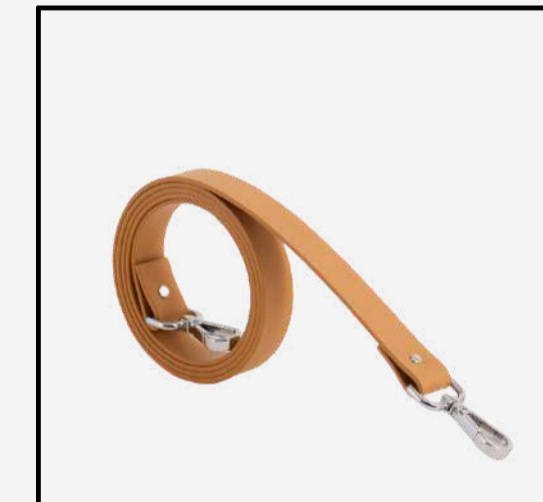

TOSTADO



NAVY



VERDE TRÉBOL



AZUL BIENHECHA

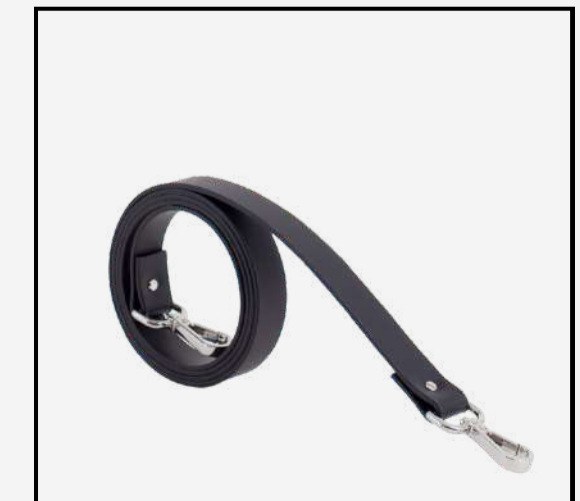

NEGRO MATE



CUERO RECICLADO

## PENDIENTES

Nuestros pendientes se hacen aprovechando todos los retales de cuero reciclado y poniendo kilos y kilos de amor en cada pieza.

DESCÚBRELOS

## PENDIENTES

# CLARA

- No pesan nada
- Son antialérgicos (la fornitura es de acero quirúrgico)
- Hechos artesanalmente con pequeños retales de nuestro cuero para reducir nuestro residuo y aprovechar todito lo que tenemos en el taller
- Cantos lujados y pintados a mano uno a uno
- Medidas: 1,5 cm (por su parte más anchita) x 2,5 cm de alto (Milímetros arriba o abajo, que están hechos a mano :))
- Pídelos en tu paleta de color

COMPRAR

PVP RETAIL: 39,95€

\*Accede a tu cuenta para ver tu precio wholesale

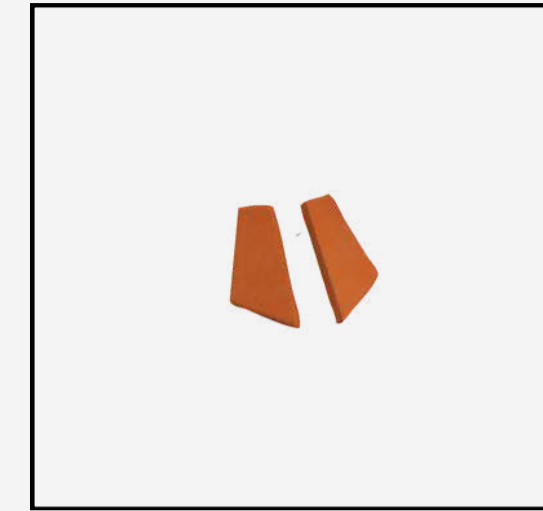

TEJA

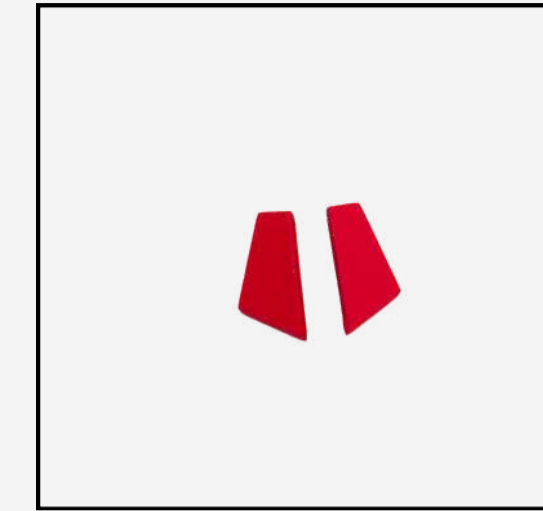

ROJO



NEGRO BOOM

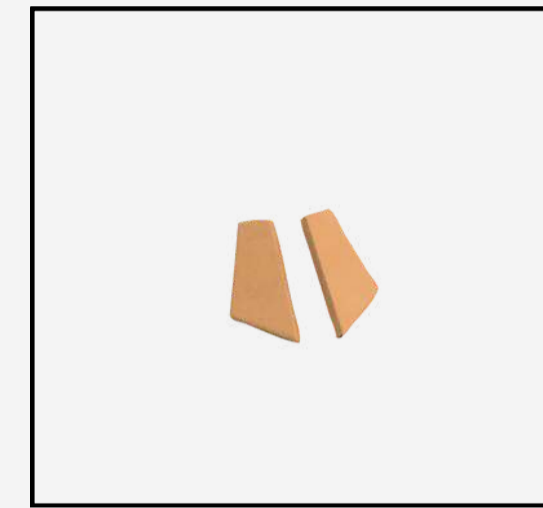

NUDE

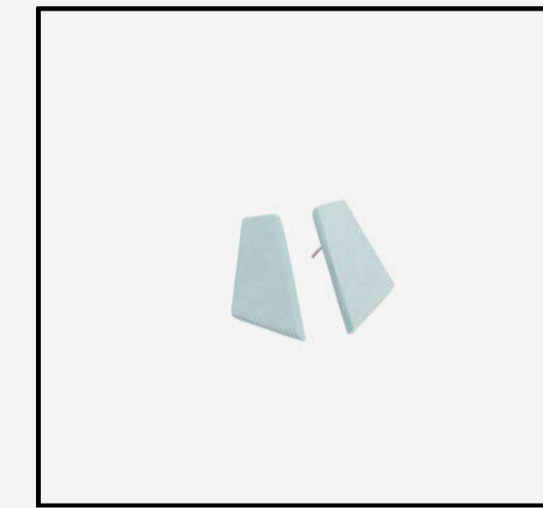

CELESTE

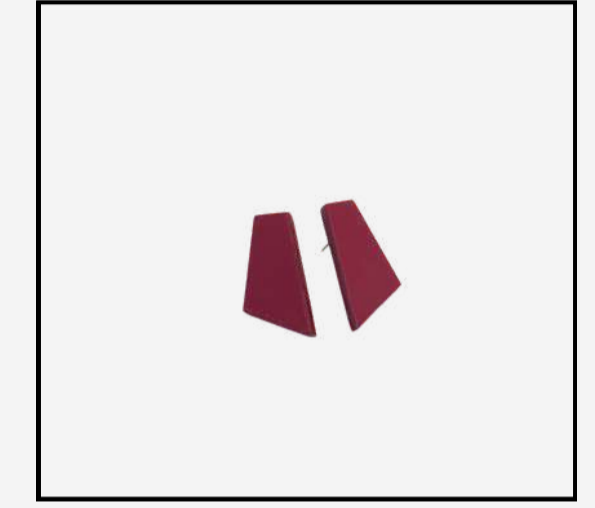

VINO

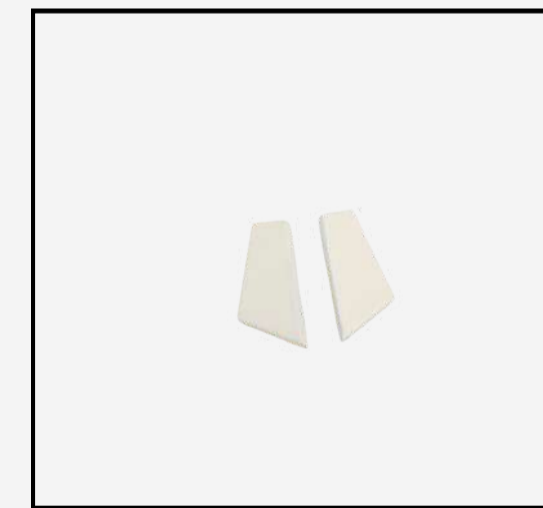

CRUDO

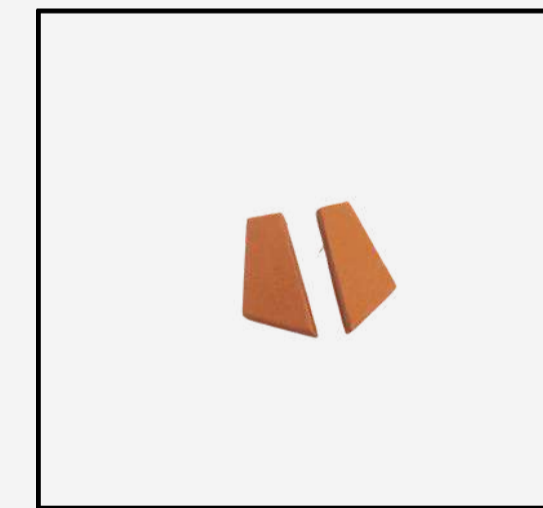

TOSTADO

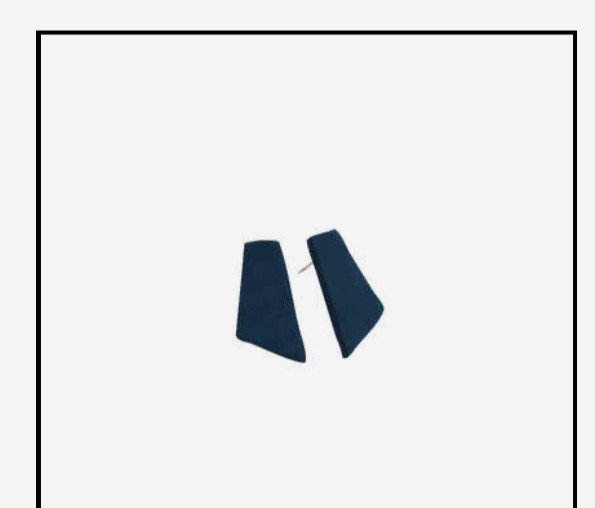

NAVY

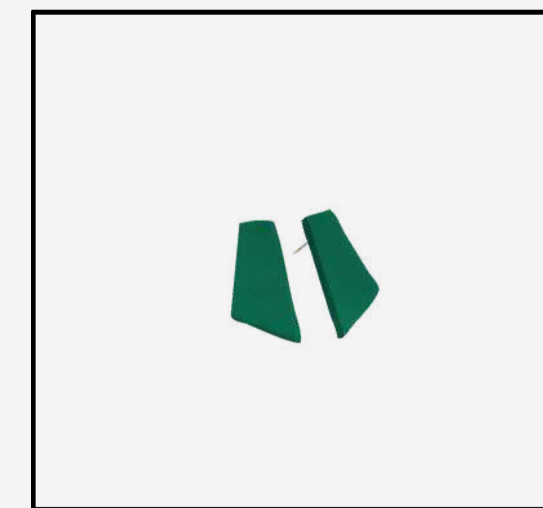

VERDE TRÉBOL

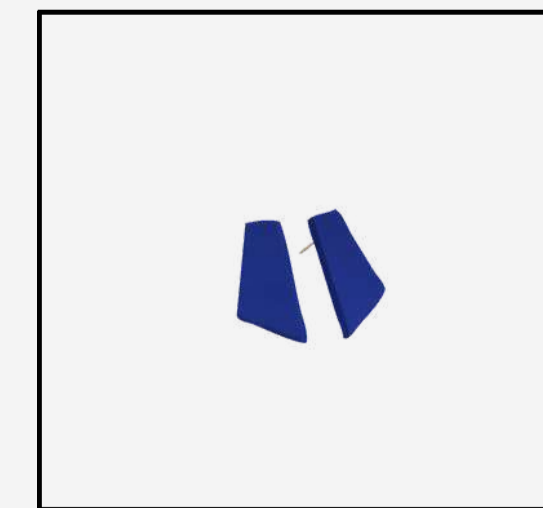

AZUL BIENHECHA

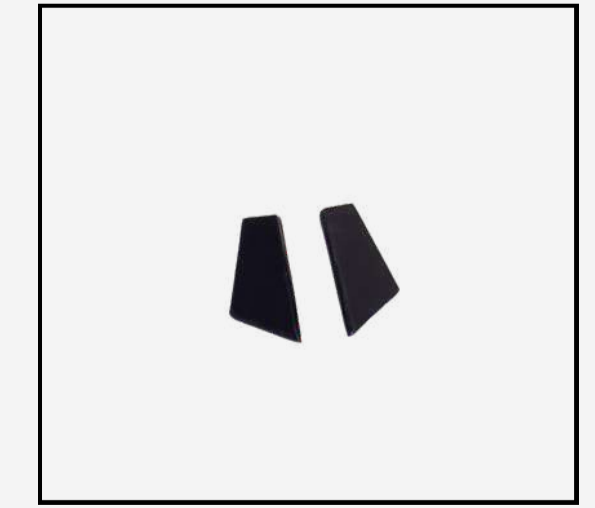

NEGRO MATE

## PENDIENTES

# IRENE

- No pesan nada
- Son antialérgicos (la fornitura es de acero quirúrgico)
- Hechos artesanalmente con pequeños retales de nuestro cuero para reducir nuestro residuo y aprovechar todito lo que tenemos en el taller
- Cantos lujados y pintados a mano uno a uno
- Medidas: 2 cm (por su parte más anchita) x 5 cm de alto (Milímetros arriba o abajo, que están hechos a mano :))
- Pídelos en tu paleta de color

COMPRAR

PVP RETAIL: 44,95€

\*Accede a tu cuenta para ver tu precio wholesale

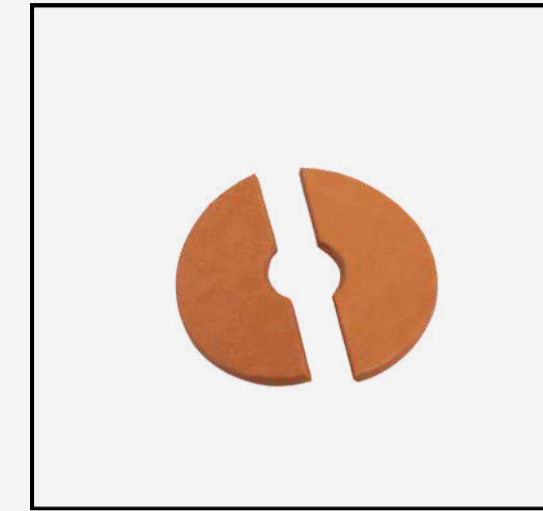

TEJA

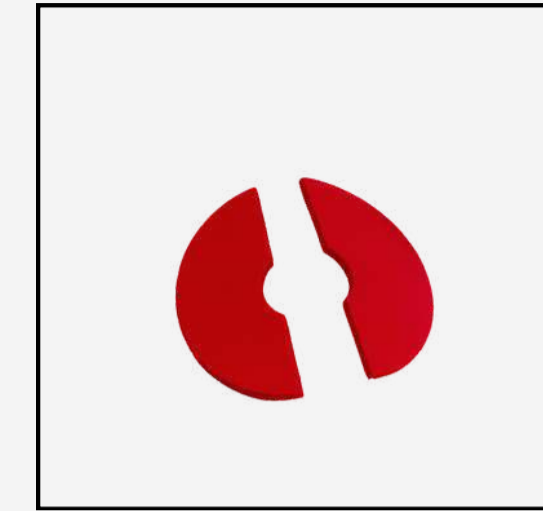

ROJO



NEGRO BOOM

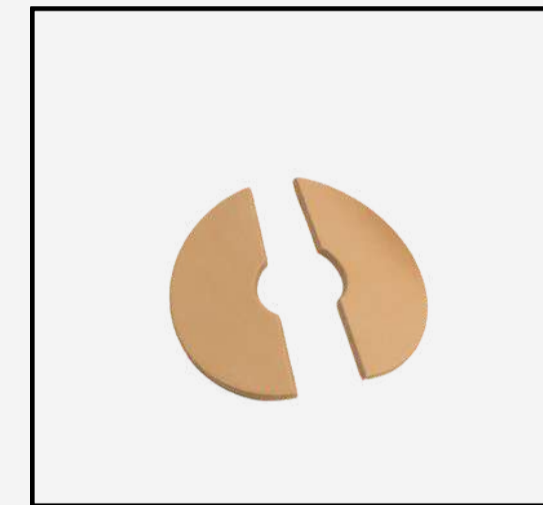

NUDE

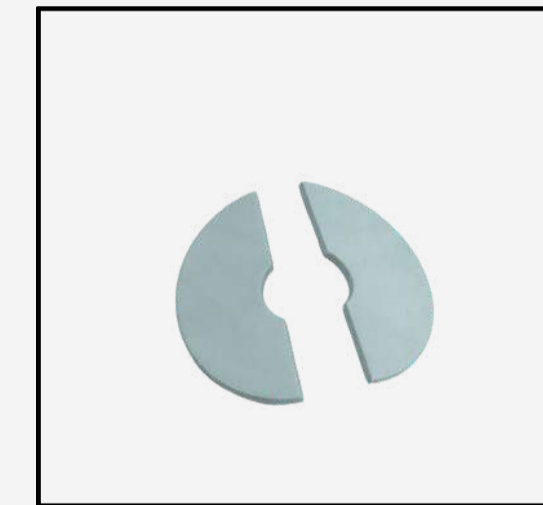

CELESTE

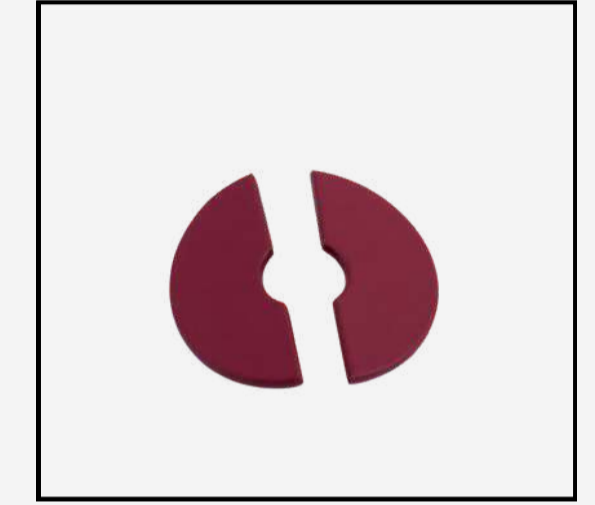

VINO

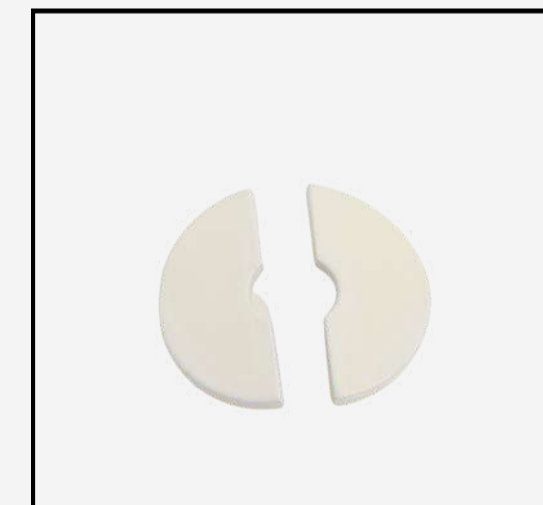

CRUDO

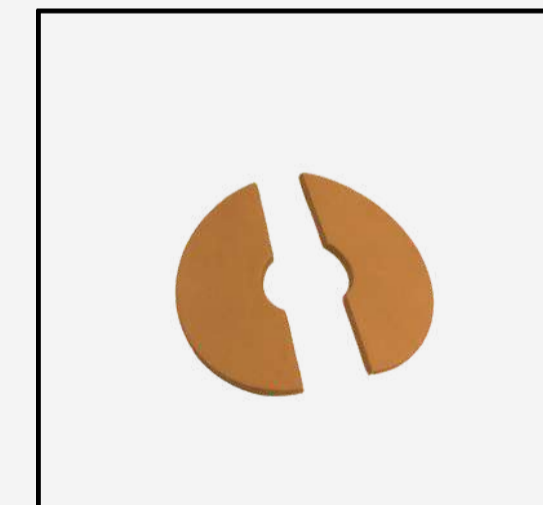

TOSTADO

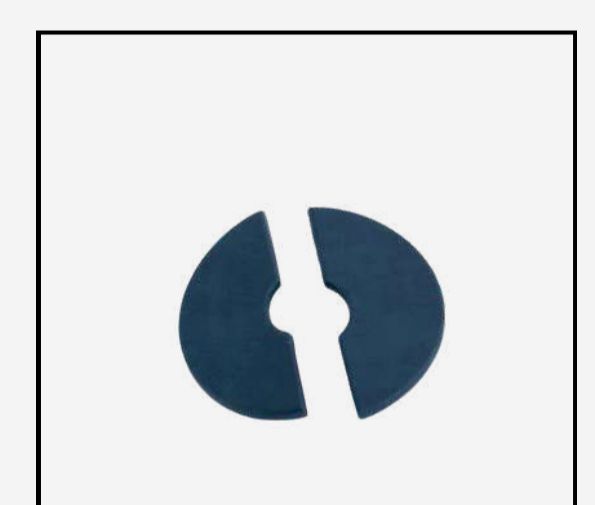

NAVY

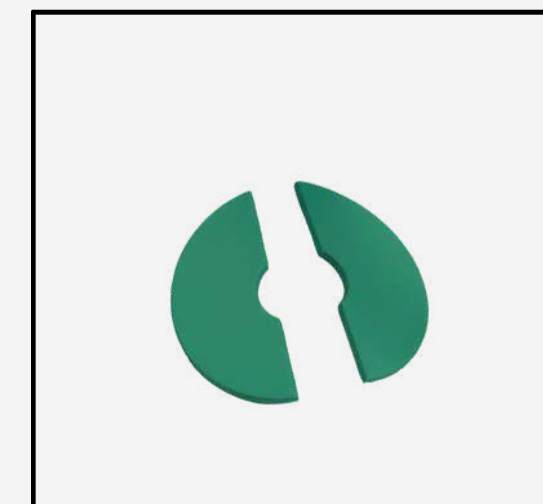

VERDE TRÉBOL

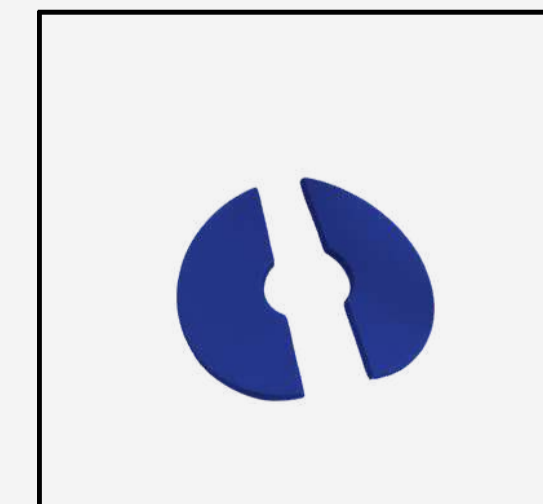

AZUL BIENHECHA

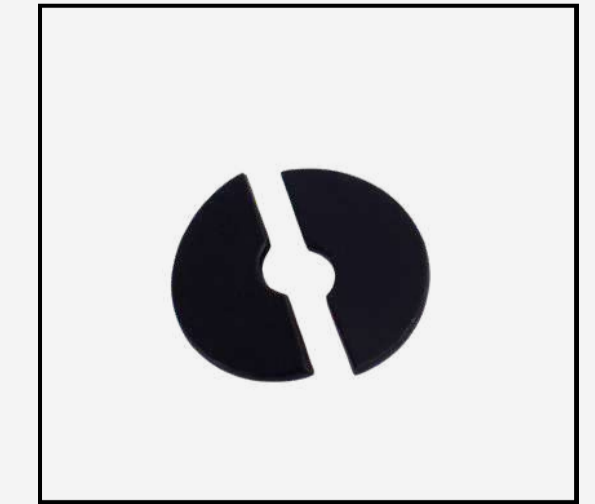

NEGRO MATE

## PENDIENTES

# ANA

- No pesan nada
- Son antialérgicos (la fornitura es de acero quirúrgico)
- Hechos artesanalmente con pequeños retales de nuestro cuero para reducir nuestro residuo y aprovechar todito lo que tenemos en el taller
- Cantos lujados y pintados a mano uno a uno
- Medidas: 2,5 cm (por su parte más anchita) x 3 cm de alto (Milímetros arriba o abajo, que están hechos a mano :))
- Pídelos en tu paleta de color

COMPRAR

PVP RETAIL: 44,95€

\*Accede a tu cuenta para ver tu precio wholesale

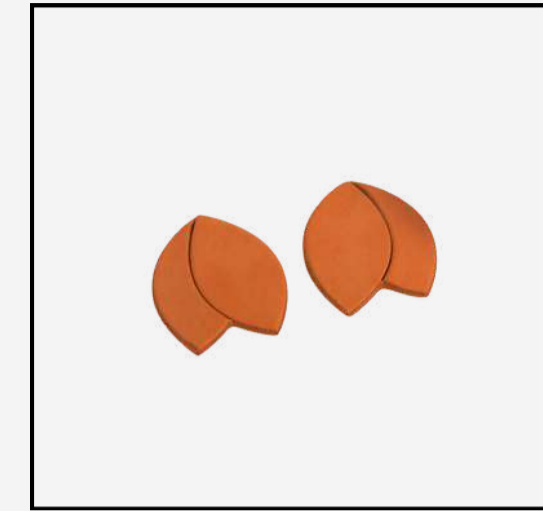

TEJA

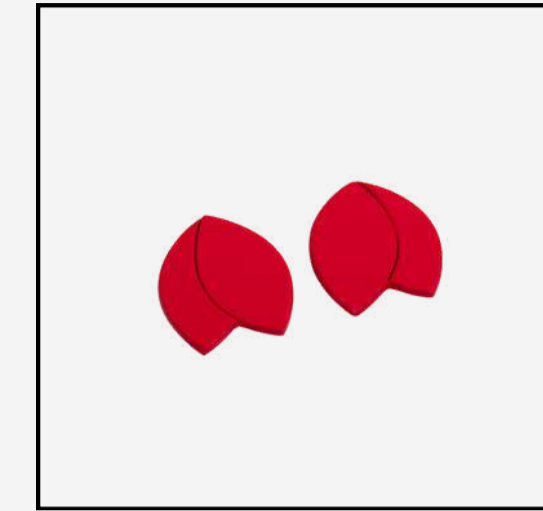

ROJO



NEGRO BOOM

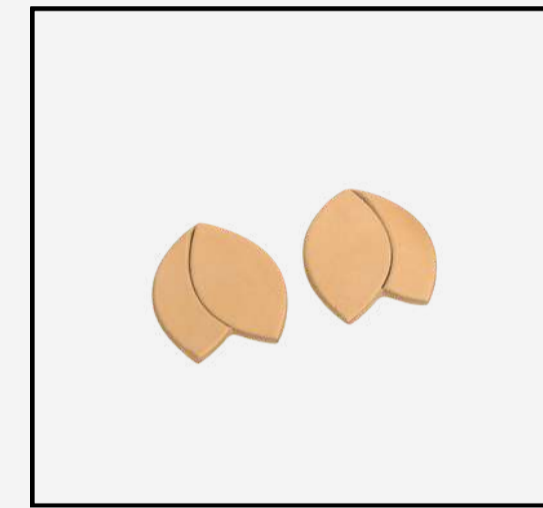

NUDE

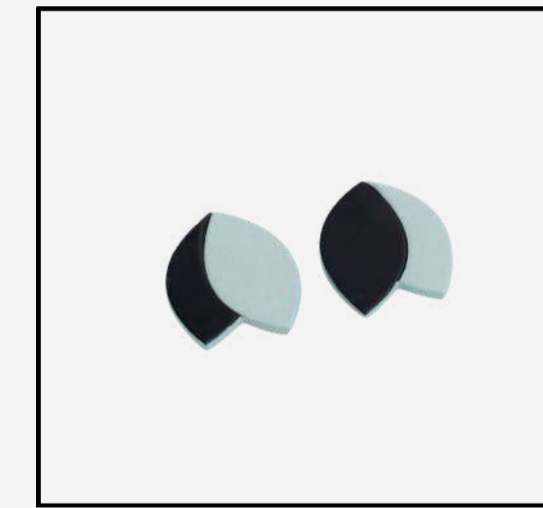

CELESTE

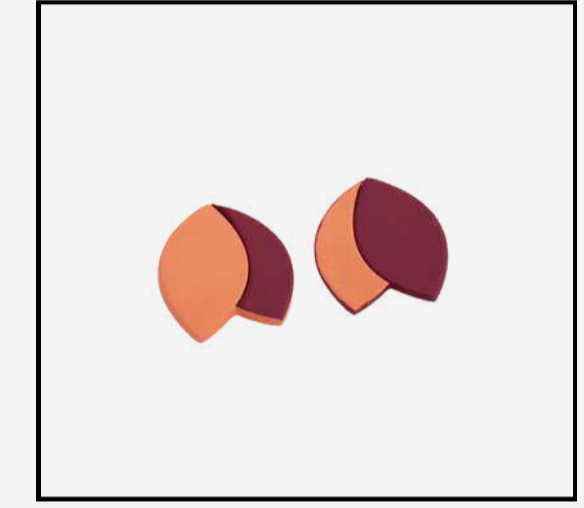

VINO

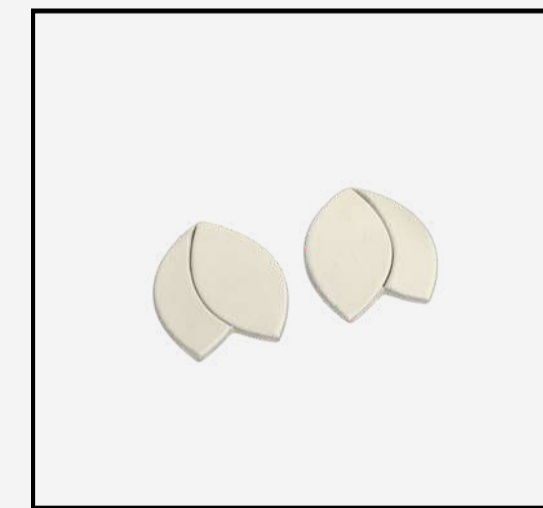

CRUDO



TOSTADO



NAVY

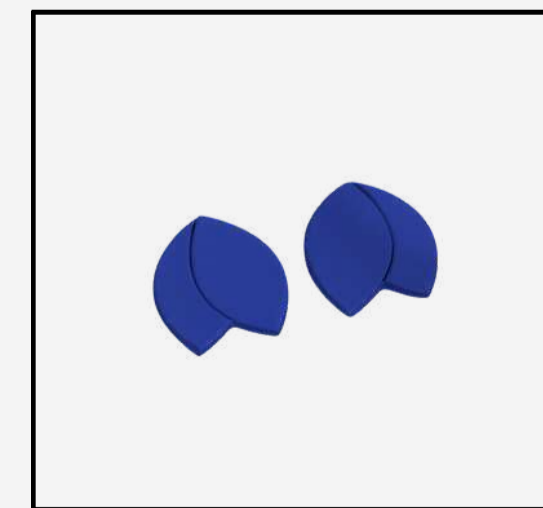

VERDE TRÉBOL

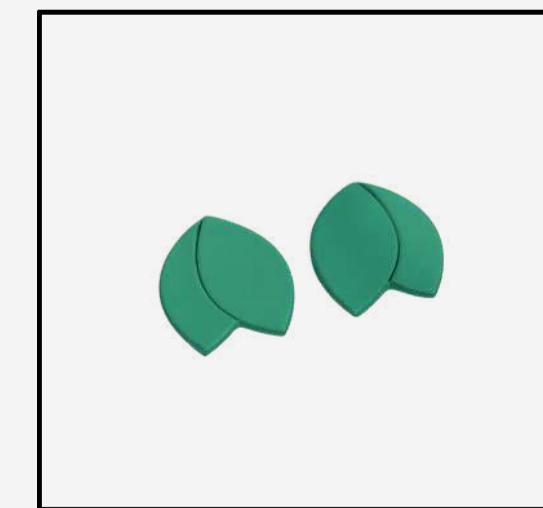

AZUL BIENHECHA

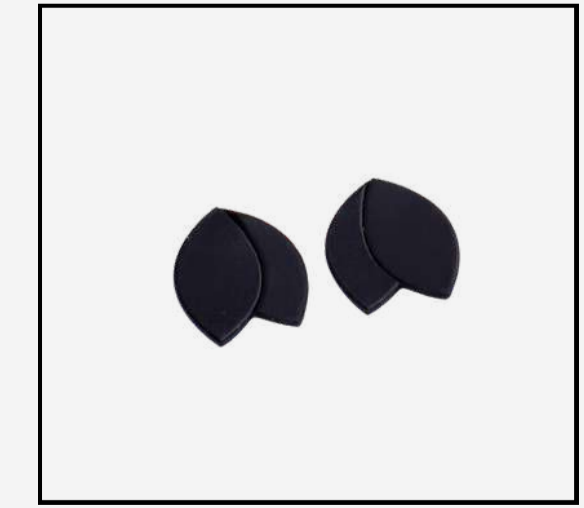

NEGRO MATE



## PENDIENTES

# CRISTINA

- No pesan nada
- Son antialérgicos (la fornitura es de acero quirúrgico)
- Hechos artesanalmente con pequeños retales de nuestro cuero para reducir nuestro residuo y aprovechar todito lo que tenemos en el taller.
- Cantos lujados y pintados a mano, uno a uno.
- Medidas: 3,6 cm (por su parte más anchita) x 5 cm de alto (Milímetros arriba o abajo, que están hechos a mano :))
- Pídelos en tu paleta de color

COMPRAR

PVP RETAIL: 54,95€

\*Accede a tu cuenta para ver tu precio wholesale



TEJA

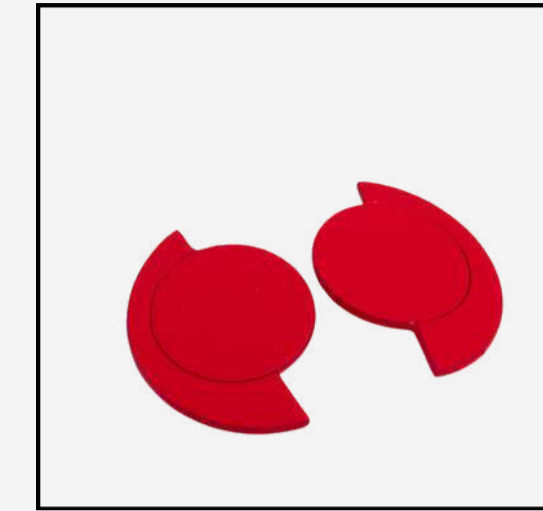

ROJO



NEGRO BOOM

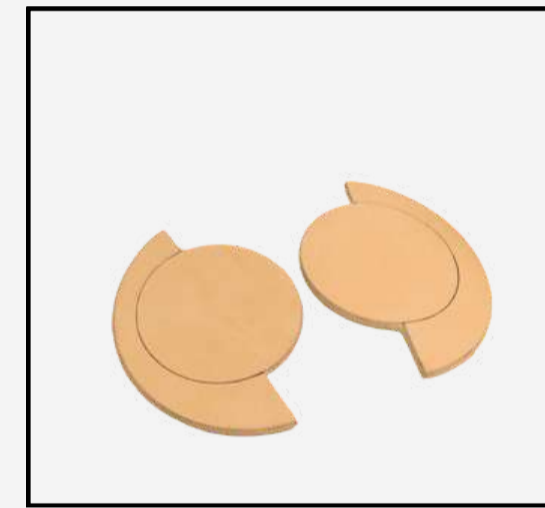

NUDE



CELESTE

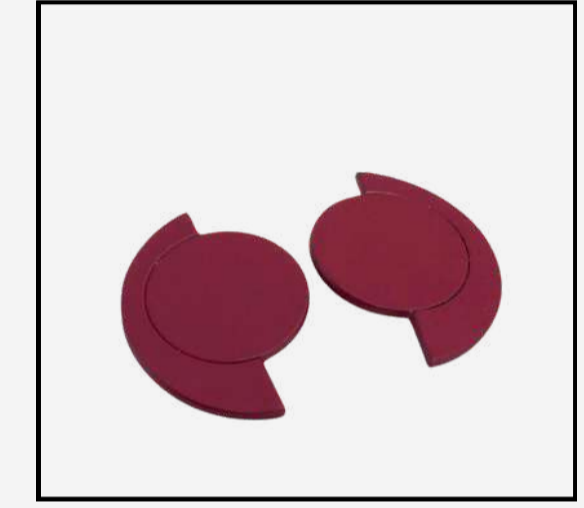

VINO



CRUDO



TOSTADO



NAVY

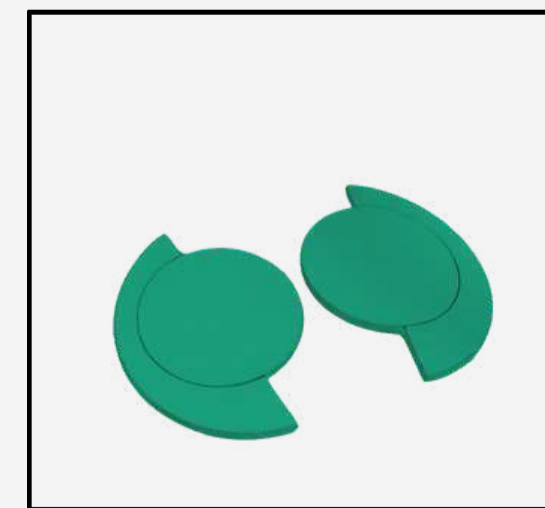

VERDE TRÉBOL

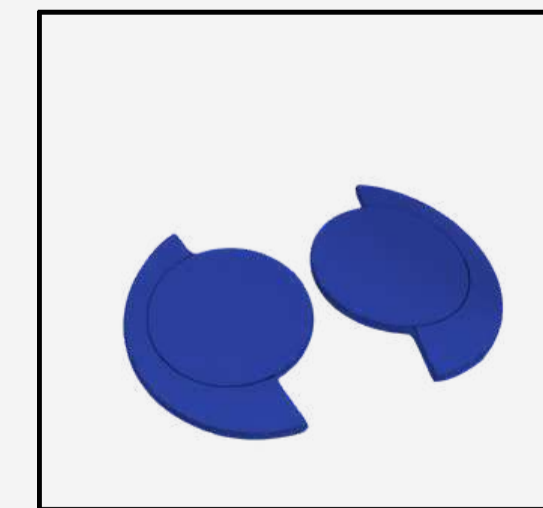

AZUL BIENHECHA

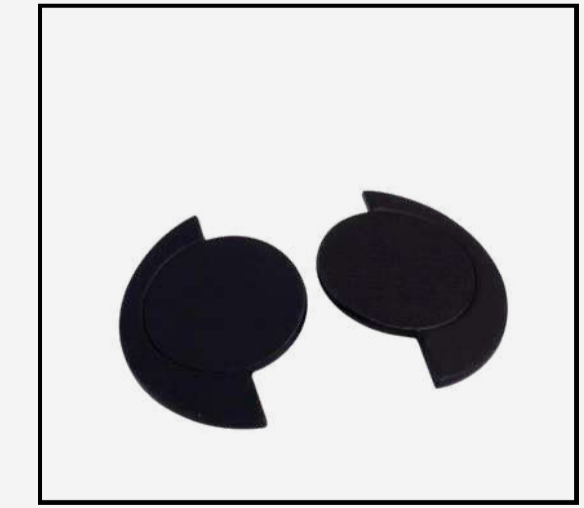

NEGRO MATE

TOP 10

# BEST-SELLERS

Los bienhechas que llevan mucho tiempo conquistando corazones.

Algunos llevan con nosotras desde el minuto uno... y seguimos produciéndolos sin parar.

COMPRAR



PAQUITA      [DESCÚBRELA →](#)



RAMONA      [DESCÚBRELA →](#)



PEPA      [DESCÚBRELA →](#)



SOFÍA (HIJA)      [DESCÚBRELA →](#)



ANGELINES      [DESCÚBRELA →](#)



SOFÍA (MADRE)      [DESCÚBRELA →](#)



ENCARNITA (LM)      [DESCÚBRELA →](#)



BERNARDITA      [DESCÚBRELA →](#)



BERNARDA      [DESCÚBRELA →](#)



JOSEFA      [DESCÚBRELA →](#)



¿QUIÉNES SOMOS?

## **SOBRE LABIENHECHA**

Somos un equipo de mujeres haciendo cosas (bienhechas) en un taller en Málaga y trabajando en torno a tres líneas de acción: crear un producto de calidad, local y ecológico; crear consciencia en torno a lo sostenible; y, además, empoderar el papel femenino en el emprendimiento y en la vida en general.

**¿Lo que más nos enorgullece de nuestro proyecto?**

- Producto 100 % artesanal, local y ecológico
- Hecho en España, en nuestro taller, de forma responsable y ética
- Materiales sostenibles de primera calidad, siempre certificados
- Empoderamos el emprendimiento femenino



¿CÓMO LO HACEMOS?

DESCÚBRELA

## NUESTRO TALLER

Todo lo que hacemos se produce en nuestro propio taller, con nuestras propias manos, de manera artesanal y honesta, intentando dañar lo menos posible nuestro entorno, esforzándonos para mantener viva la tradición y, por supuesto, con kilos de amor.

En Labienhecha nos encargamos de todo. Cuando decimos todo es TODO. Desde la idea, el diseño y la confección del bolso, hasta el marketing, la comercialización, administración... ¡Todo!

¿CÓMO LO HACEMOS?

## PRODUCCIÓN SOSTENIBLE

Creemos que nada es 100 % sostenible, pero que con pequeños actos y con nuestras decisiones como marca, podemos reducir nuestro impacto negativo y fomentar una cultura en torno a la sostenibilidad.

Tenemos en cuenta todas las perspectivas en torno a la sostenibilidad (económica, medioambiental y/o social y laboral). Por eso, queremos avanzar en nuestro propio I+D, trabajando con otros materiales sostenibles y certificados, ofreciendo otras alternativas, ampliando nuestro conocimiento, mejorando nuestros recursos para conseguir mejores resultados, optimizando nuestro taller y siempre apostando por dañar lo menos posible nuestro planeta.



¿CÓMO LO HACEMOS?

## NUESTROS MATERIALES

En Labienhecha nos esforzamos por investigar materiales que cumplan con nuestros altos requisitos en cuanto a sostenibilidad. Por eso, tan sólo trabajamos con materiales eco, duraderos, de calidad y que sean respetuosos con el medio ambiente y tengan el menor impacto negativo. Estos son los principales materiales con los que trabajamos:



BIOMATERIAL VEGANO



CUERO RECICLADO



ALGODÓN ORGÁNICO

# AYUDA

---

ALTA NUEVO CLIENTE →

ACCESO CLIENTE →

PORTAL COMPRA B2B →

PEDIDO RÁPIDO →

SOLICITAR DEMO →

PROMOCIONES →

FAQS →

[CUENTA CLIENTE](#)

[ORDER FORM](#)



NO HACEMOS COSAS PERFECTAS,  
TAN SOLO HACEMOS COSAS BIENHECHAS

---

## Labienhecha

### CONTACTO

C/ Croacia, 19. CP: 29004 - Málaga, España  
sales@labienhecha.com

### SOCIAL & WEB

FB: Labienhecha  
IG: @soylabienhecha  
WEB: labienhecha.com

### INFO

Diseñamos y creamos bolsos y otras cosas bonitas usando solo eco-materiales certificados. Todo está hecho a fuego lento en un pequeño taller de Málaga por un súper equipo de mujeres que aman lo que hacen.