



Labienhecha

INDEX

RECYCLED LEATHER →

ACCESSORIES →

EXTRAS →

EARRINGS →

TOP 10 - BEST-SELLERS →

ABOUT LABIENHECHA →

OUR WORKSHOP →

CLIENT AREA B2B →

CLIENT ACCOUNT

ORDER FORM



OUR OGS

RECYCLED LEATHER COLLECTION

The core of our collection. They are the ones that have been with us since the very beginning and they don't seem to be going away. Labienhecha icons (and the best sellers). We produce them with recycled leather from a local supplier certified with Global Recycled Standard and Oeko Tex Leather Standard.

DISCOVER

THEY NEVER MISS

SUPER TOP

The all-time favourites (and best sellers). They have been in our collection for years and have become true Labienhecha icons.

SHOP



PAQUITA

DISCOVER →



PACA

DISCOVER →



SOFÍA (HIJA)

DISCOVER →



SOFÍA (MADRE)

DISCOVER →



PEPA

DISCOVER →



JOSEFA

DISCOVER →

THE HEARTROBBERS

THE MOST WANTED

They stand out for their special shape and their personality. Unique jewels of our collection that will make anyone fall in love.

SHOP

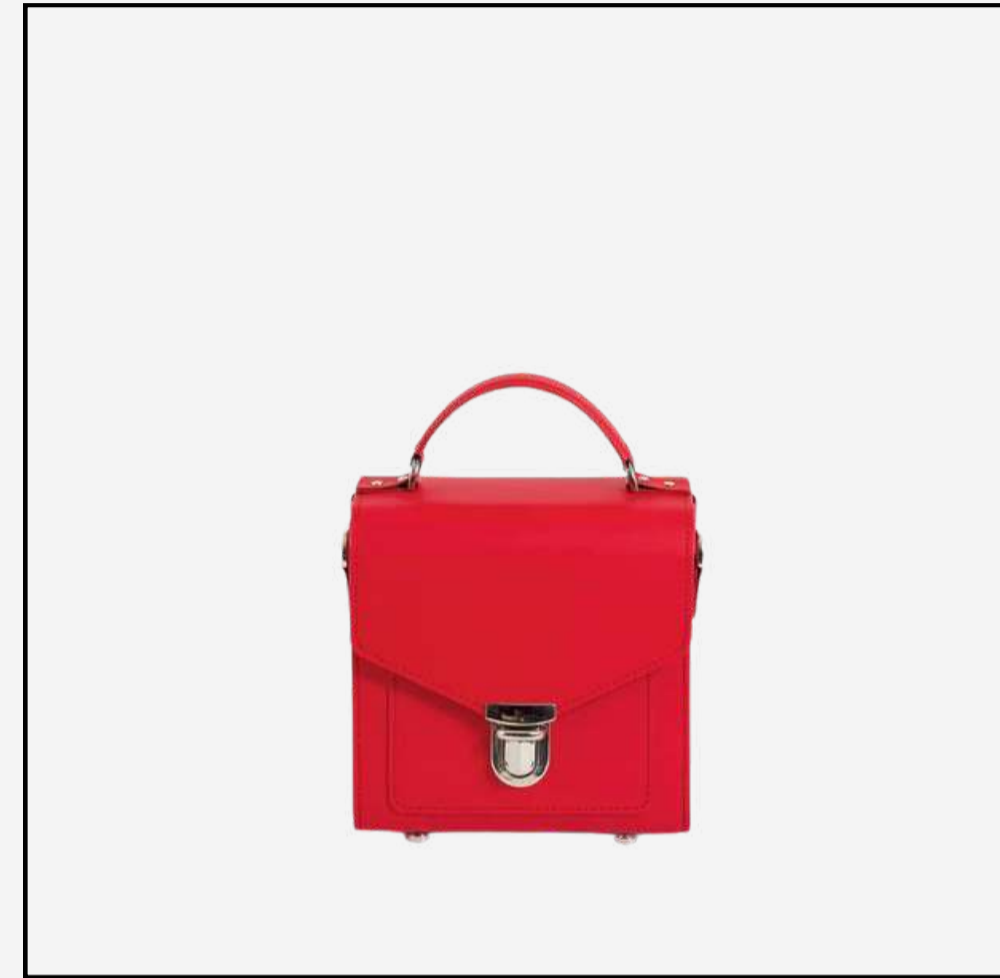

RAMONA

DISCOVER →



LOLA (THE ELDER ONE)

DISCOVER →



MARCELA

DISCOVER →



BERNARDA

DISCOVER →



MARCELINA

DISCOVER →



BERNARDITA

DISCOVER →

THEY NEVER MISS

NOT SO BASIC BASICS

A collection of lightweight, versatile bags in different sizes to cover everyday needs without compromising design.

SHOP

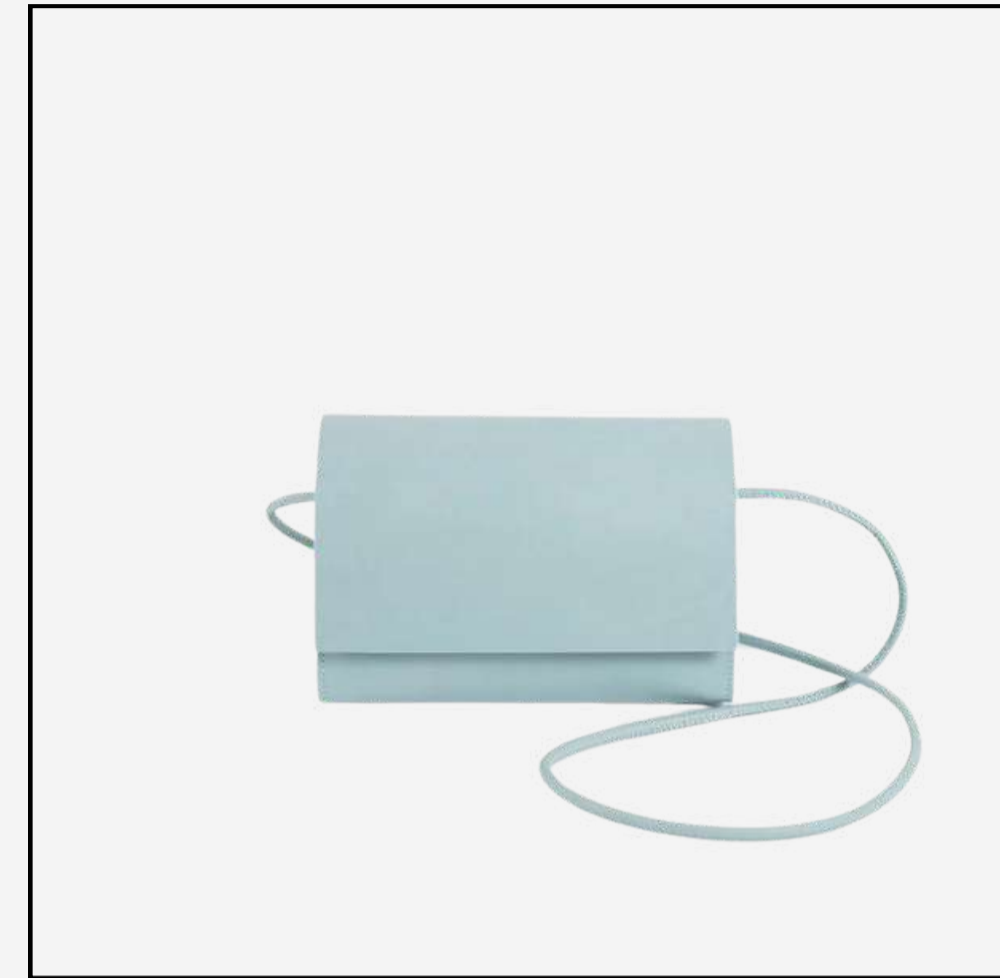

AMPARITO
(THE ELDER ONE)

DISCOVER →

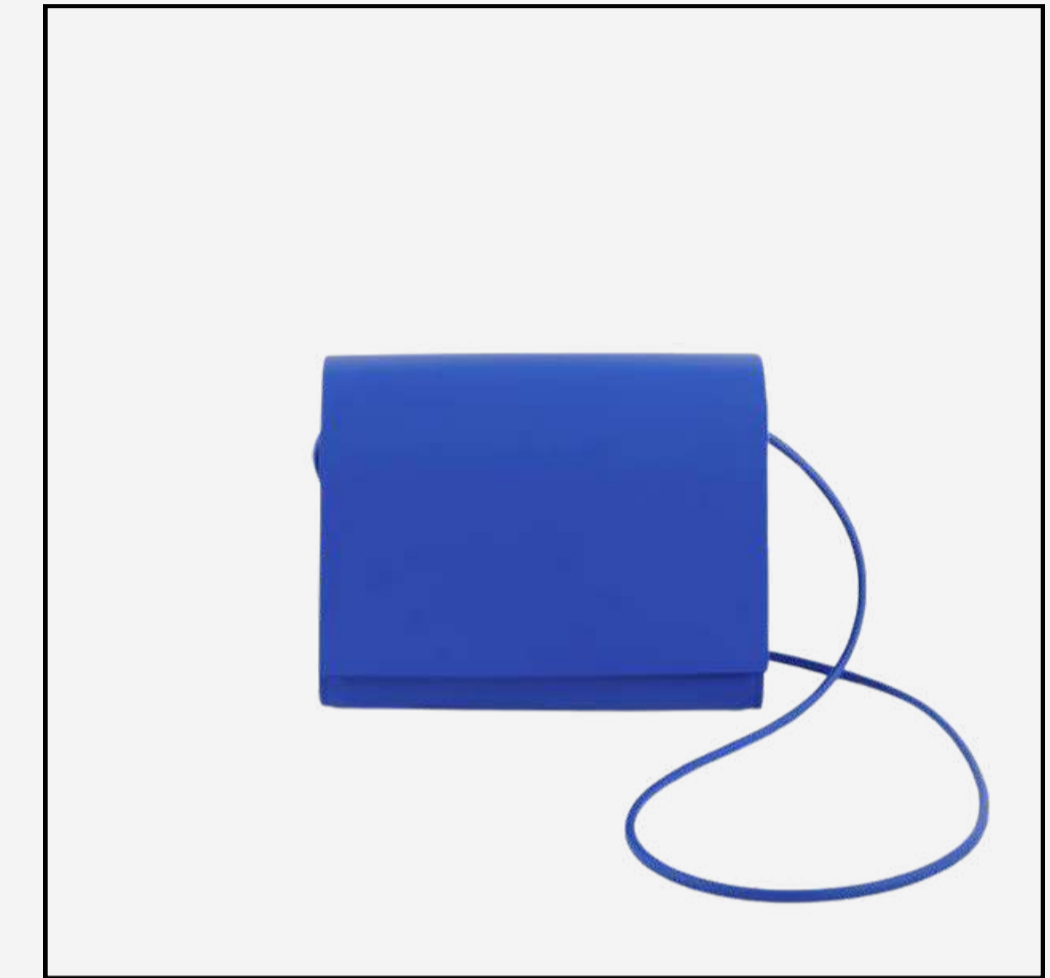

ENCARNITA
(THE ELDER ONE)

DISCOVER →

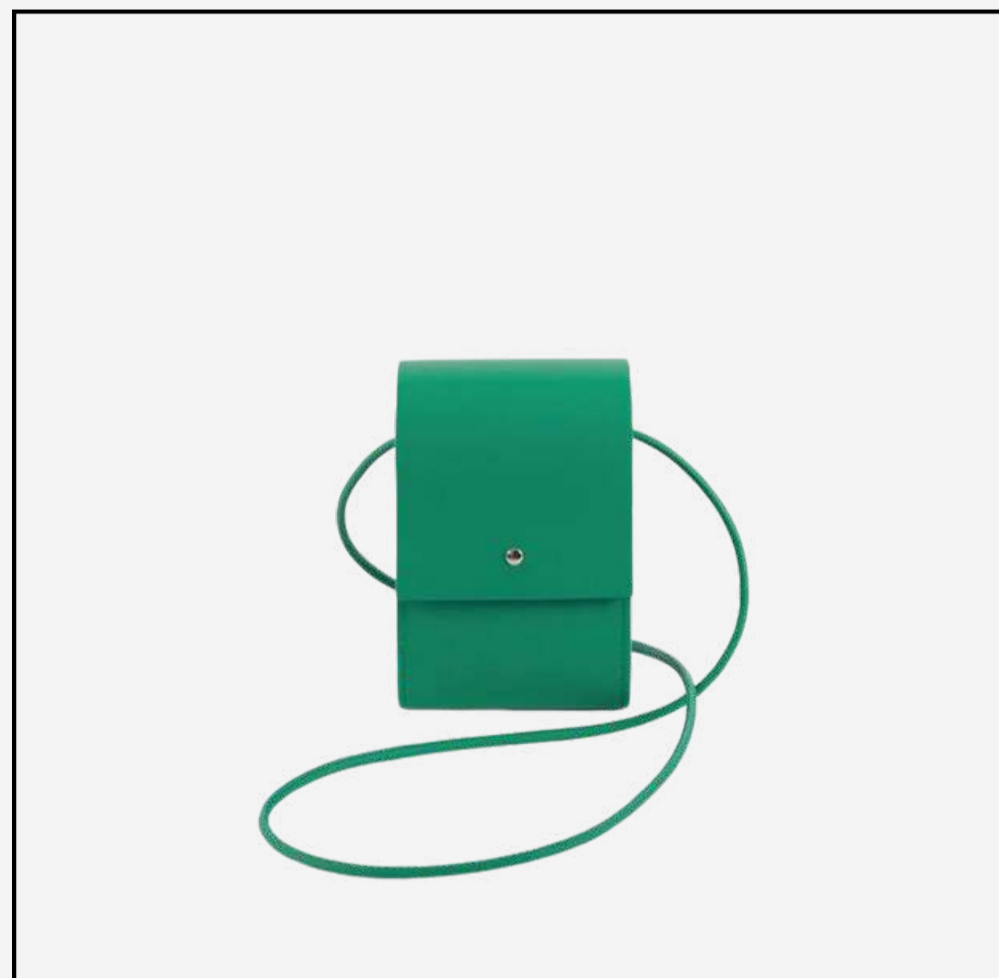

CARMELITA

DISCOVER →

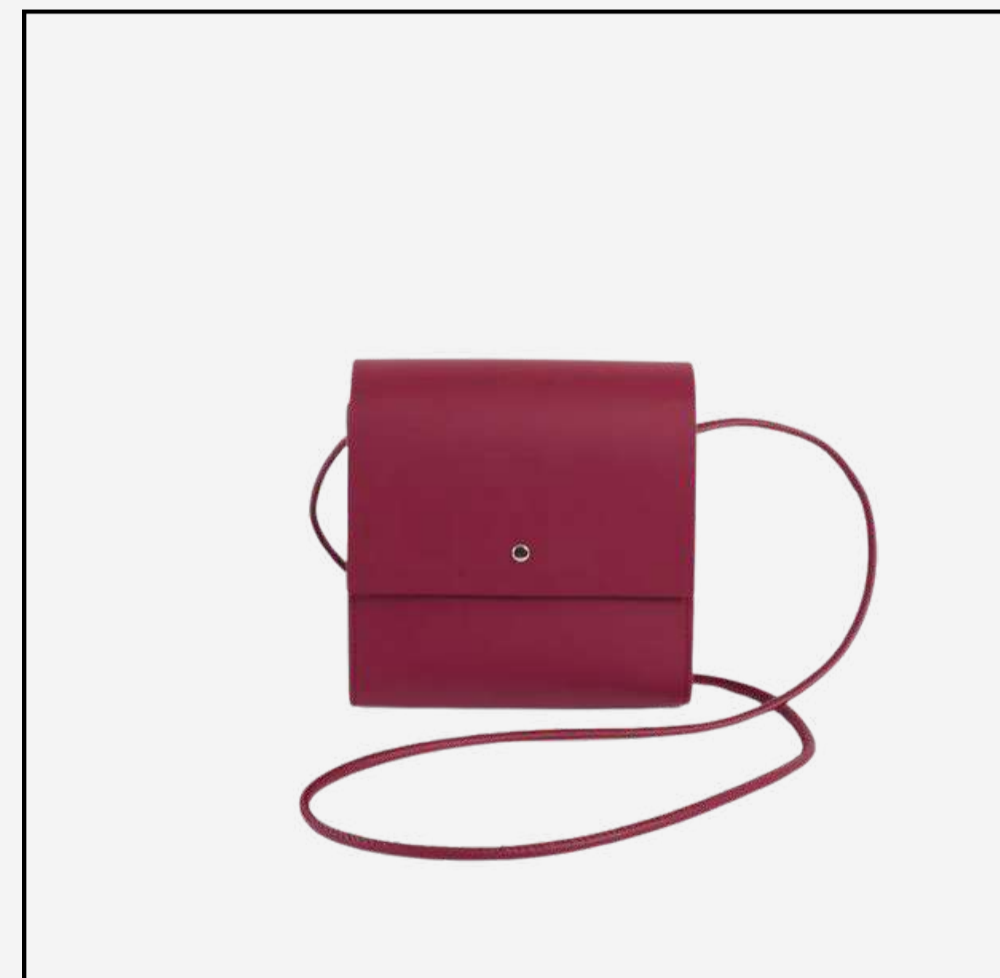

CARMELA

DISCOVER →



CARMEN

DISCOVER →

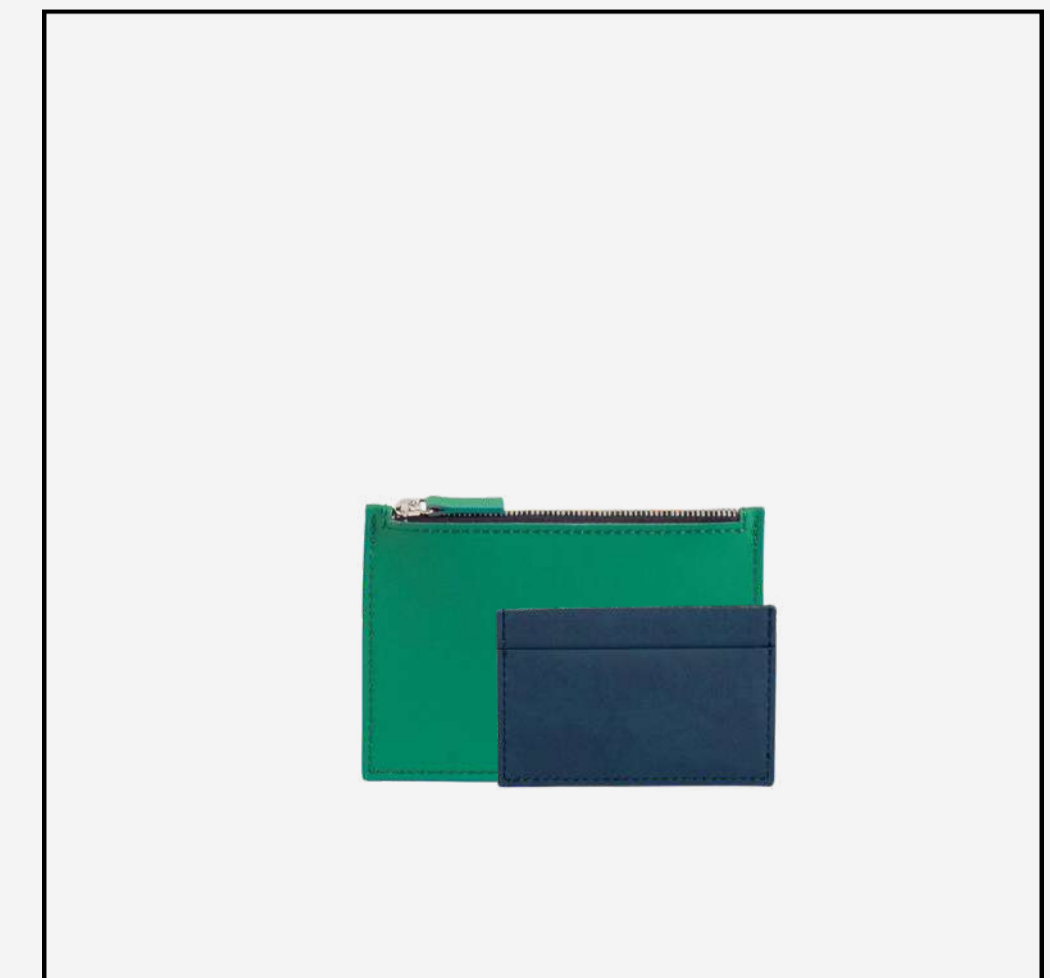

ACCESSORIES

DISCOVER →

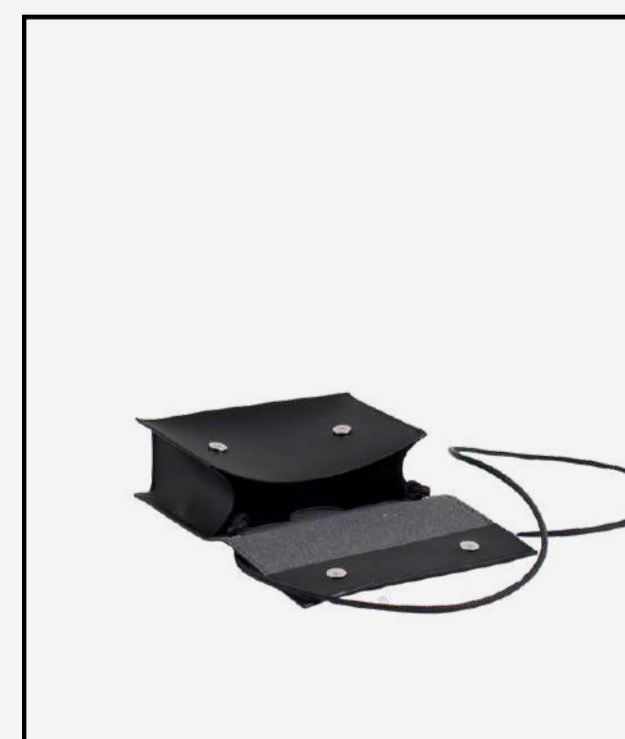

BEST SELLER - N°1

PAQUITA

Our best seller for years. Paquita is simply irresistible. A small but versatile bag that has been stealing hearts from minute one.

DISCOVER

BEST SELLER

PAQUITA

- Magnet flap fastener (double)
- One inside pocket
- Finished and painted edges for a greater protection
- Adjustable cord-strap included (140 cm)
- Extra cord-straps available: 50 cm, 100 cm, 120 cm or 140 cm
- Matching shoulder bag pad

SHOP

EXTRAS

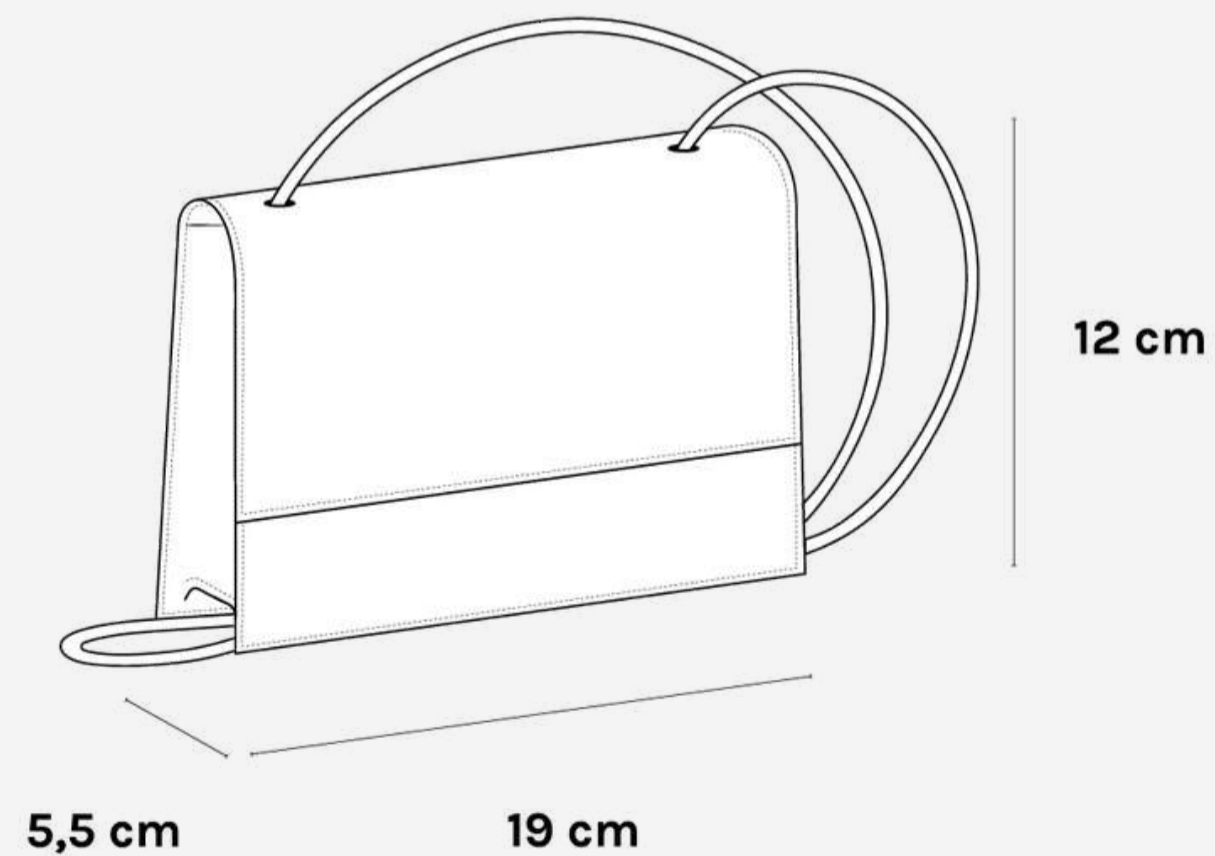

BRICK

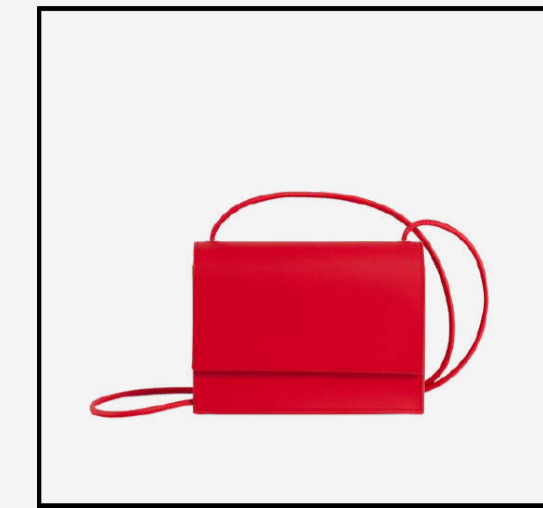

RED

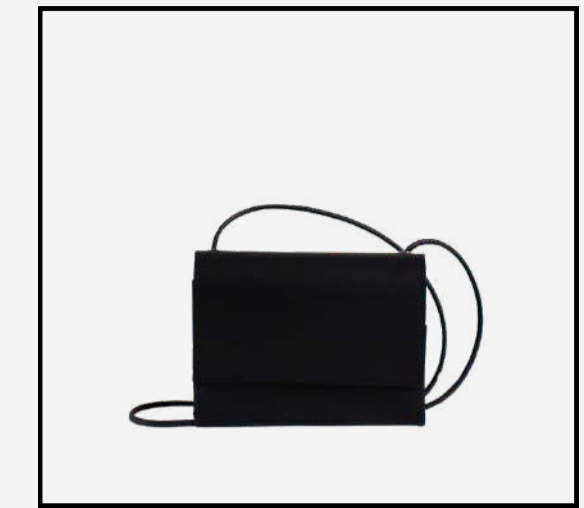

BOOM BLACK



NUDE



LIGHT-BLUE



WINE



CREAM



TANNED



NAVY

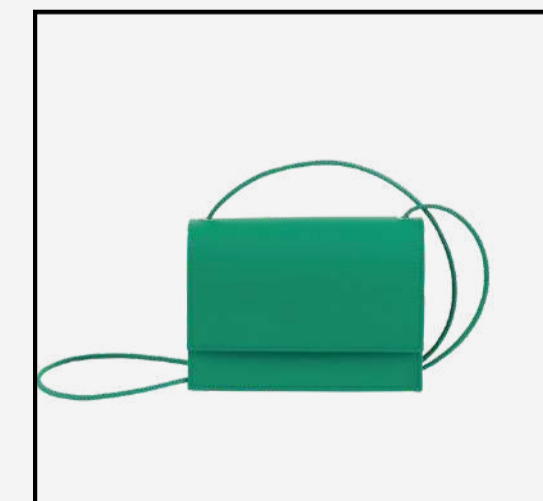

CLOVER GREEN

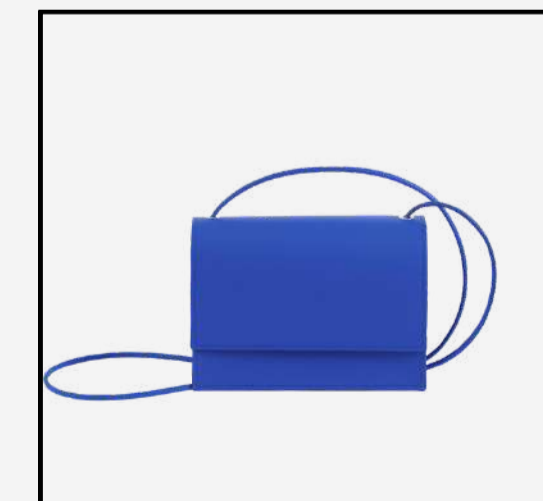

BIENHECHA BLUE



MAT BLACK



POSITIONS | * The model is 1.70 m tall



50 cm



100 cm



120 cm



140 cm
(INCLUDED)

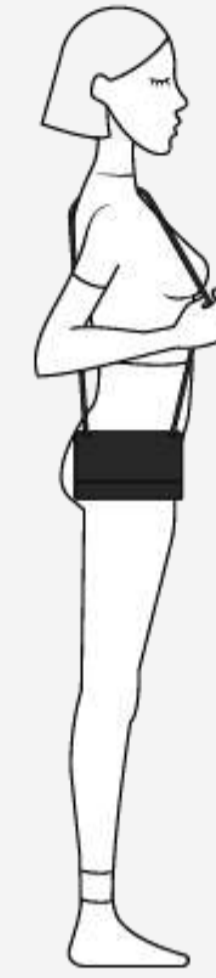

BEST SELLER

PAQUITA

SHOP

RETAIL PRICE: 149,95€

*Sign in to your account to see your wholesale price

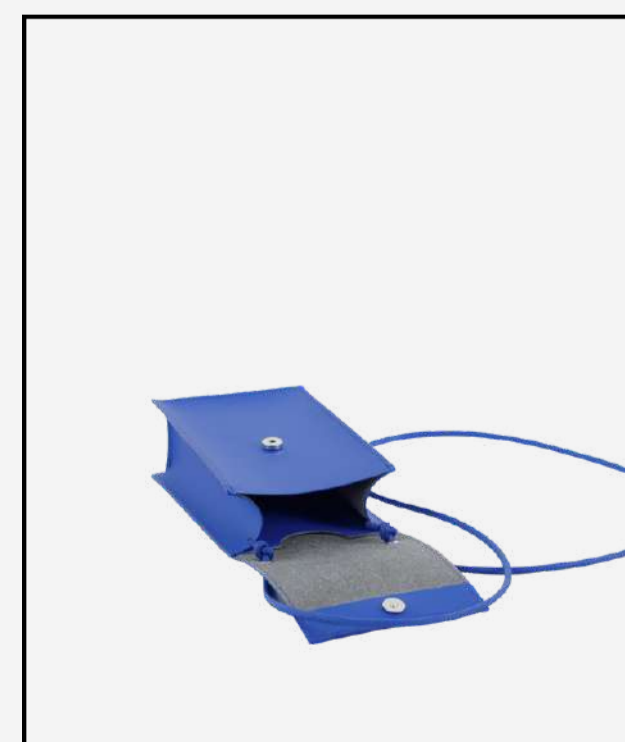

BEST SELLER

PACA

Paca is that superversatile bag for carrying exactly what you need. It has become a top seller and one of the most unisex bags in the collection.

DISCOVER

BEST SELLER

PACA

- Magnet flap fastener
- One inside pocket
- Finished and painted edges for a greater protection
- Adjustable cord-strap included (140 cm)
- Extra cord-straps available: 50 cm, 100 cm, 120 cm or 140 cm
- Matching shoulder bag pad

SHOP

EXTRAS

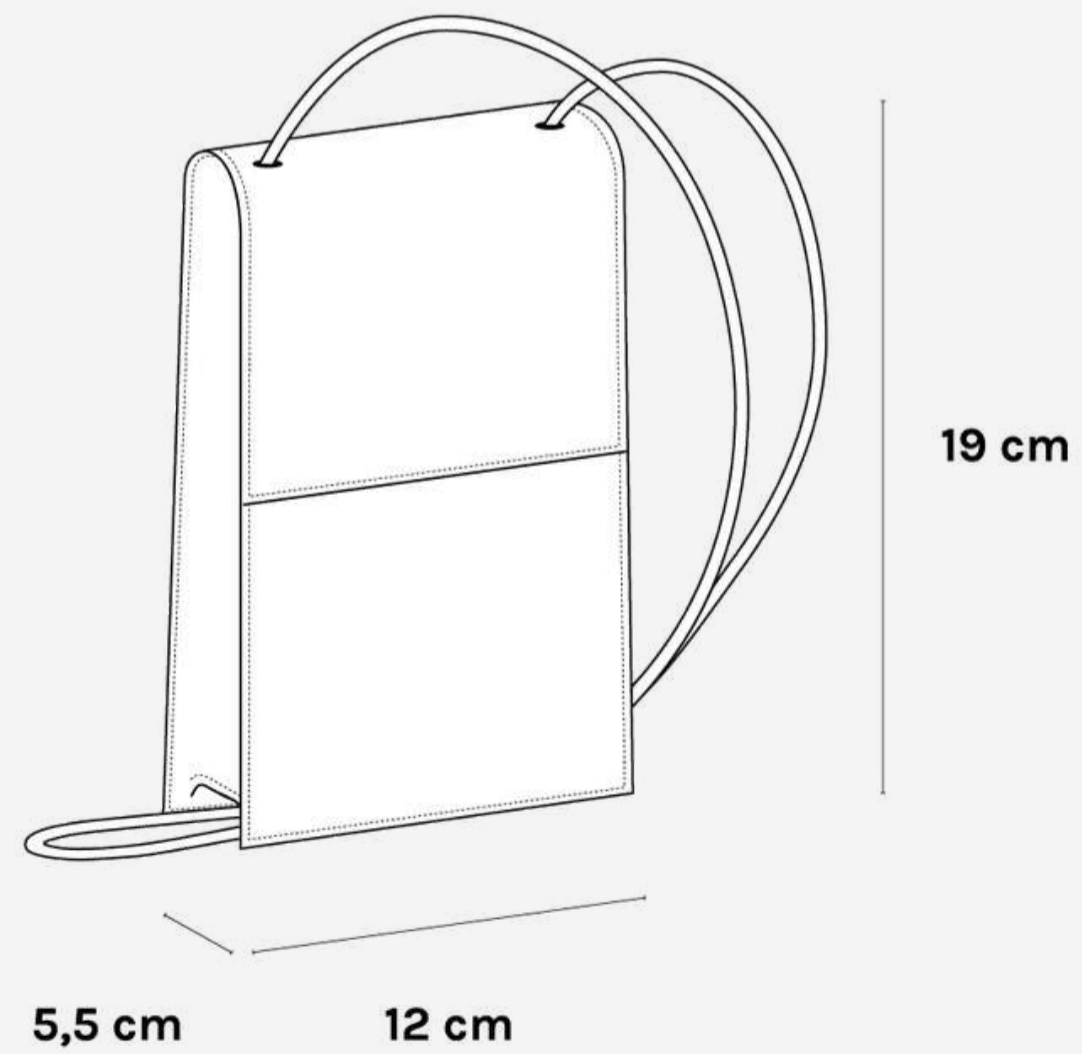

BRICK



RED



BOOM BLACK



NUDE



LIGHT-BLUE



WINE



CREAM



TANNED



NAVY



CLOVER GREEN

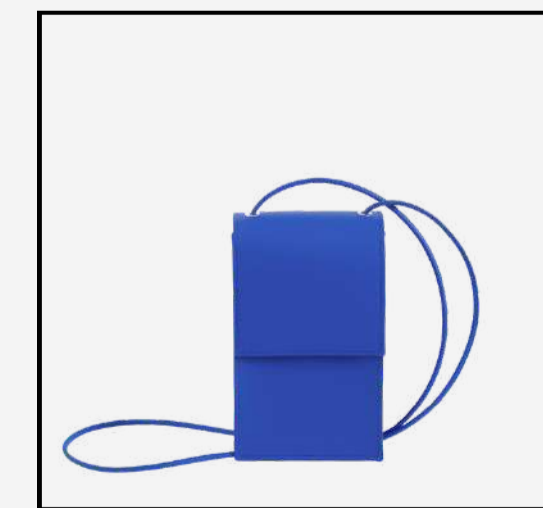

BIENHECHA BLUE



MAT BLACK



POSITIONS | * The model is 1.70 m tall



50 cm



100 cm



120 cm

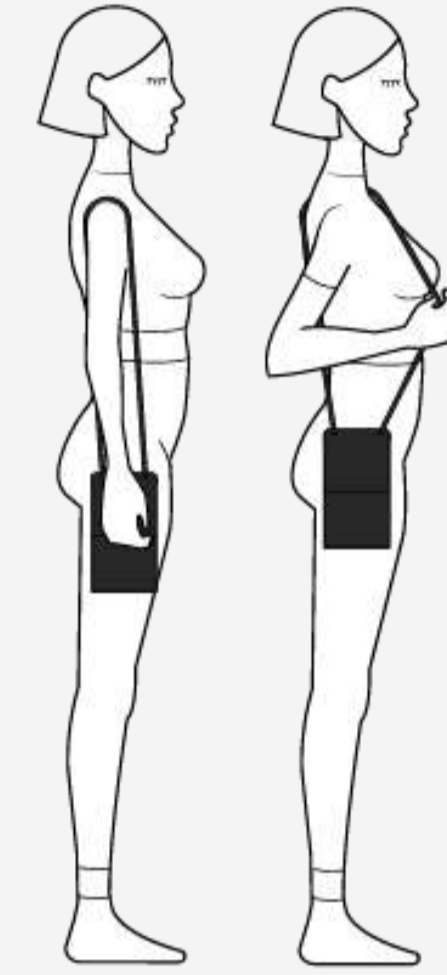

140 cm
(INCLUDED)

BEST SELLER

PACA

SHOP

RETAIL PRICE: 149,95€

*Sign in to your account to see your wholesale price

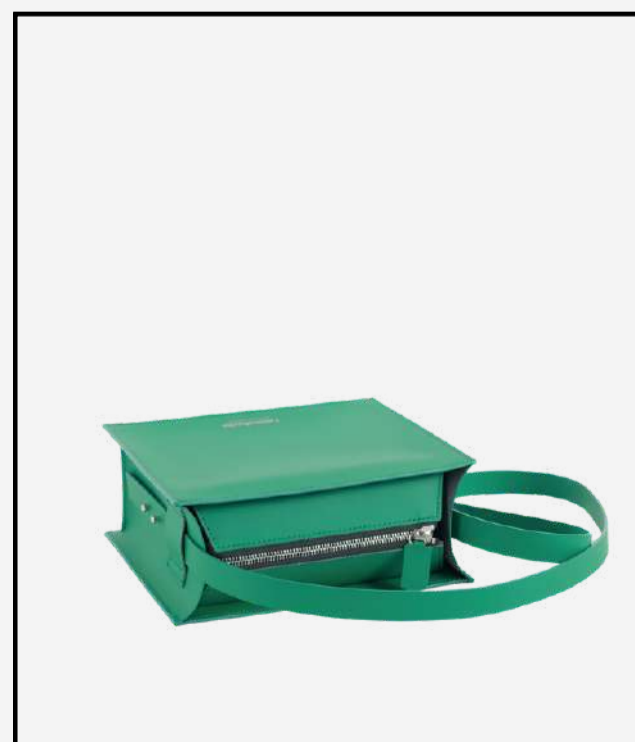
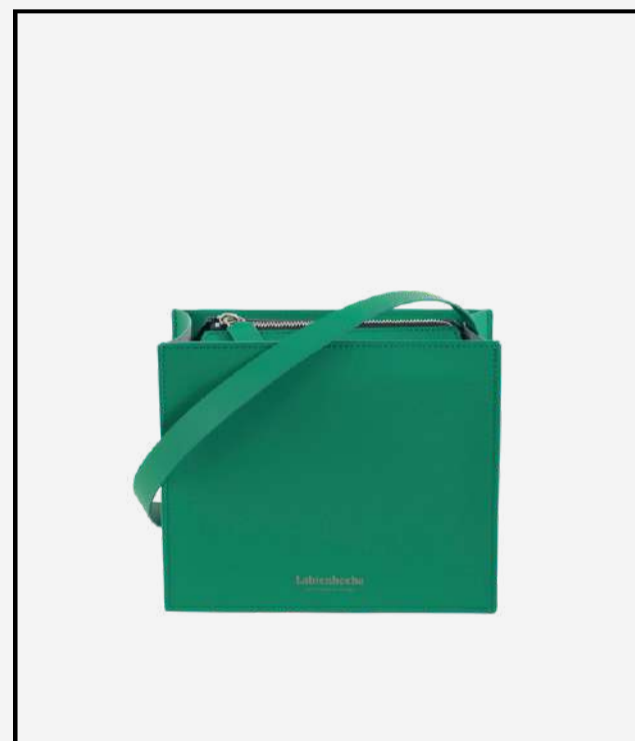

BEST SELLER

PEPA

Our first design and the second best-selling bag in Labienhecha's history. A superversatile icon thanks to its interchangeable strap set.

DISCOVER

BEST SELLER

PEPA

- Zip fastener YKK model
- Two inside pockets
- Finished and painted edges for a greater protection
- One adjustable strap included (140 cm)
- Extra straps available: 60 cm, 70 cm, 80 cm, 100 cm, 120 cm or 140 cm
- Matching accessories

SHOP

EXTRAS

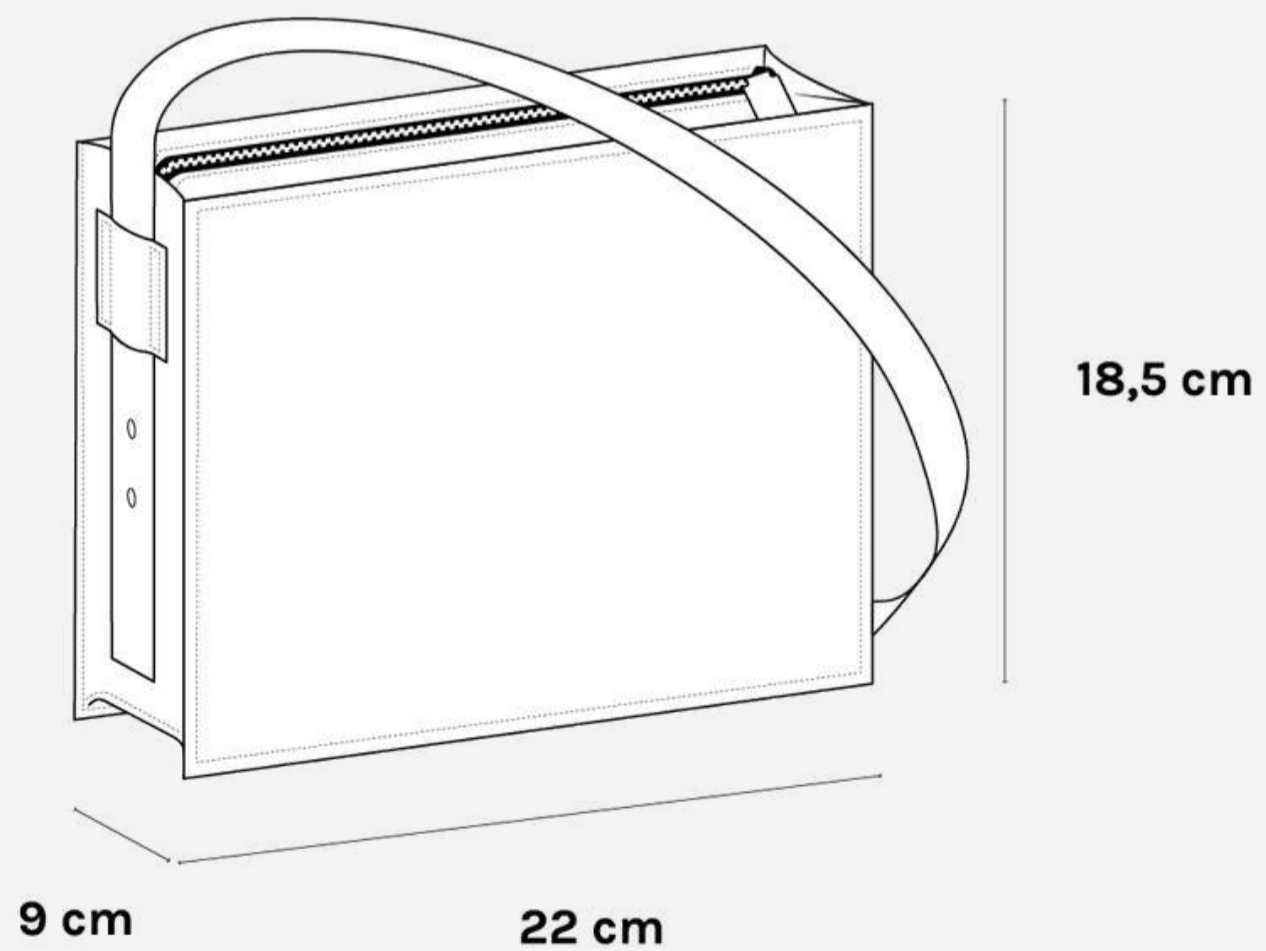

BRICK



RED



BOOM BLACK



NUDE



LIGHT-BLUE



WINE



CREAM



TANNED



NAVY



CLOVER GREEN



BIENHECHA BLUE



MAT BLACK



POSITIONS | * The model is 1.70 m tall

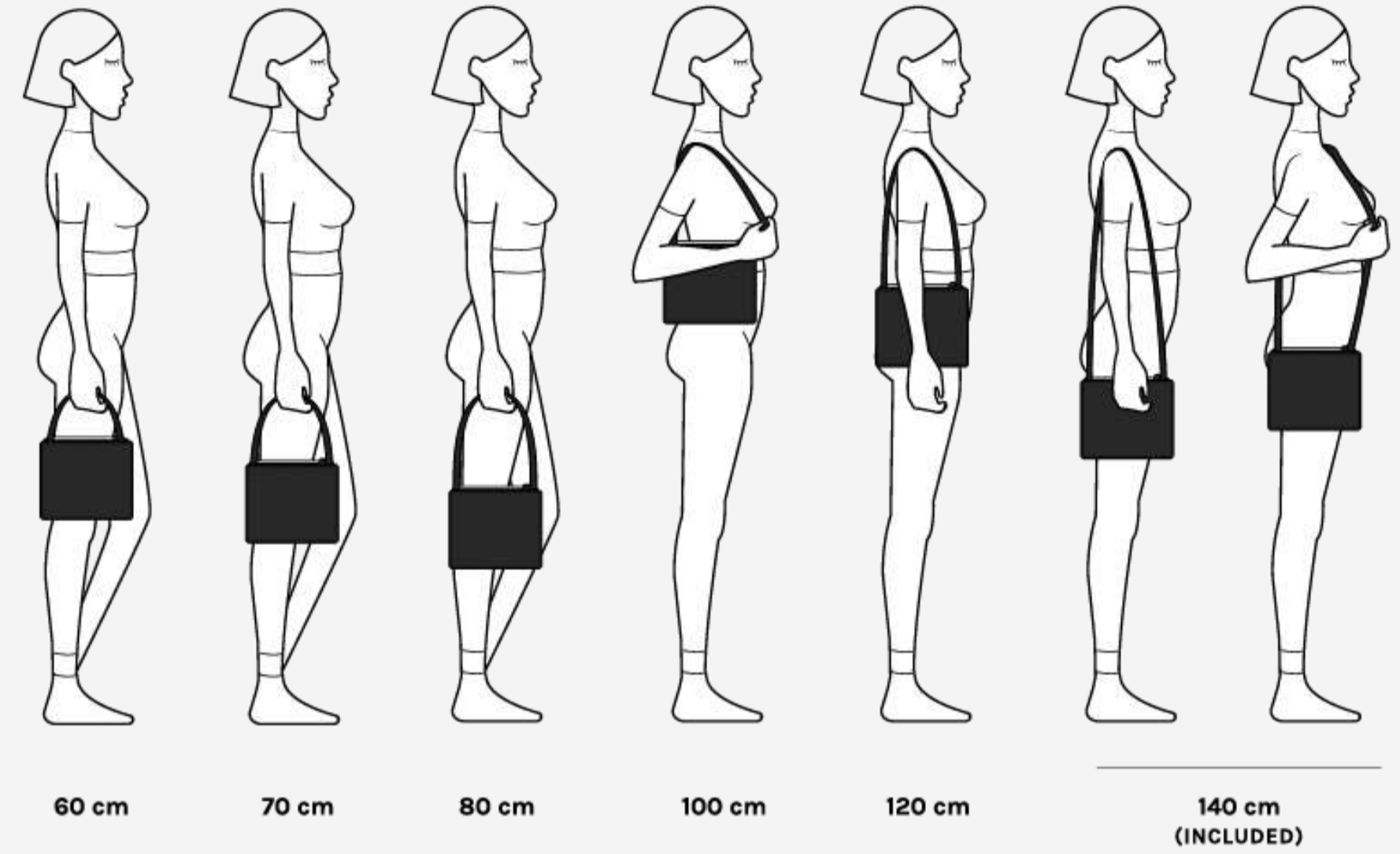

BEST SELLER

PEPA

SHOP

RETAIL PRICE: 249,95€

*Sign in to your account to see your wholesale price



BIG SIZE

JOSEFA (THE BIG PEPA)

It is a TOP of the collection, especially for those who need that extra space on a daily basis. It is the perfect companion for the office and one of the unisex bags par excellence.

DISCOVER

BIG SIZE

JOSEFA (THE BIG PEPA)

- Zip fastener YKK model
- Two inside pockets
- Finished and painted edges for a greater protection
- One adjustable strap included (140 cm)
- Extra straps available: 70 cm, 80 cm, 100 cm, 120 cm or 140 cm
- Matching accessories

SHOP

EXTRAS

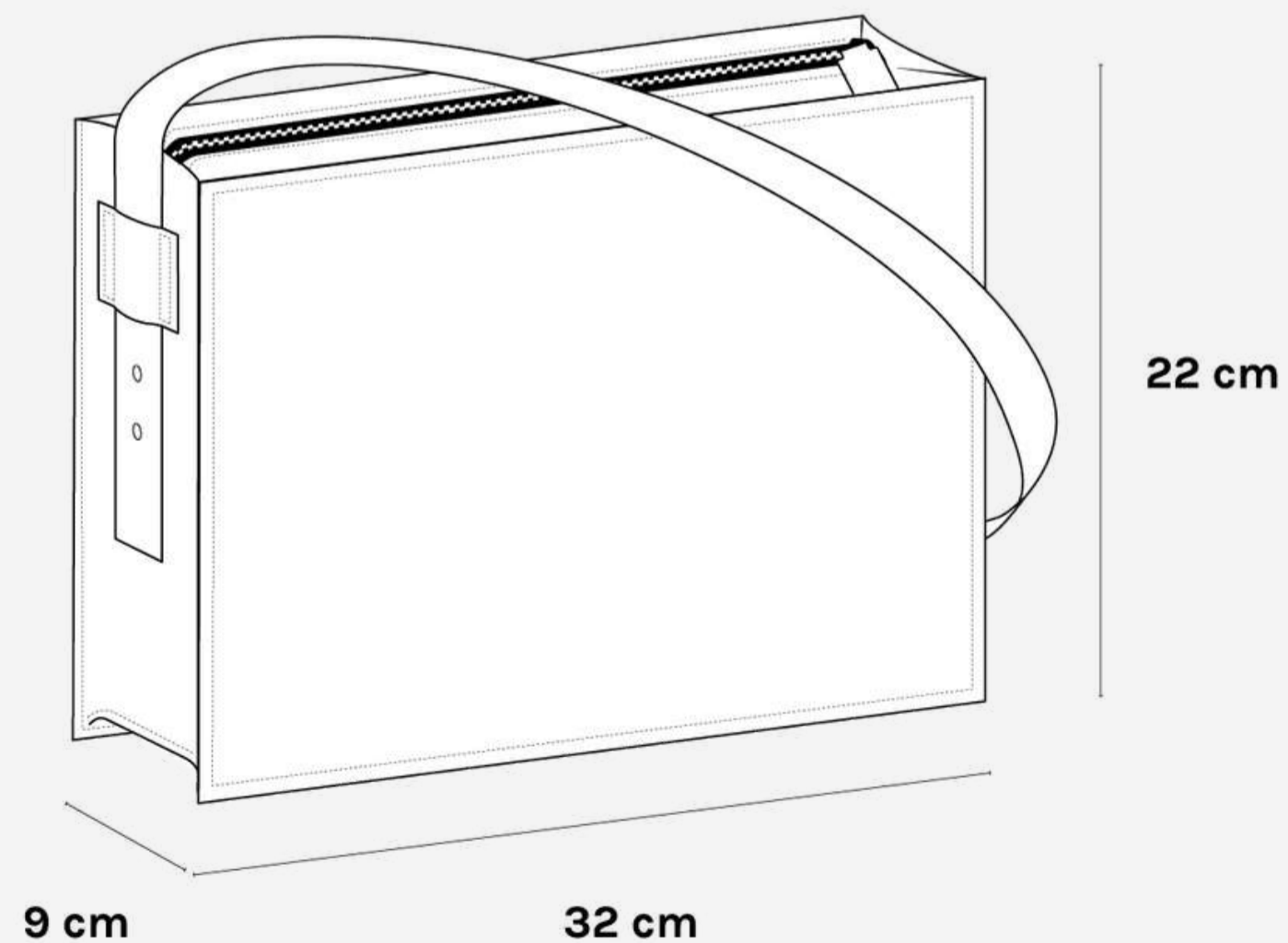

BRICK



RED



BOOM BLACK



NUDE



LIGHT-BLUE



WINE



CREAM



TANNED



NAVY



CLOVER GREEN



BIENHECHA BLUE



MAT BLACK



POSITIONS | * The model is 1.70 m tall

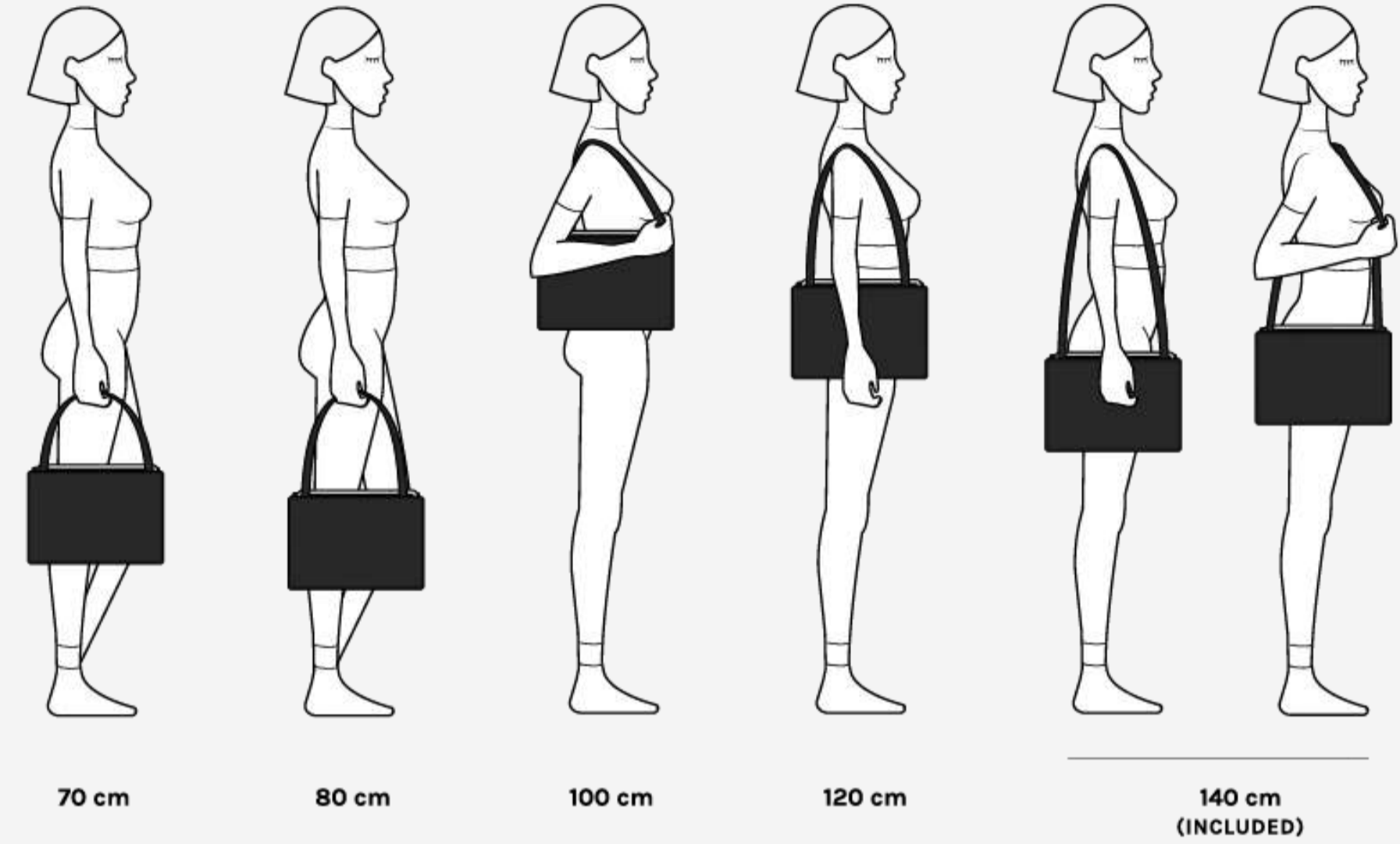

BIG SIZE

JOSEFA (THE BIG PEPA)

SHOP

RETAIL PRICE: 299,95€

*Sign in to your account to see your wholesale price

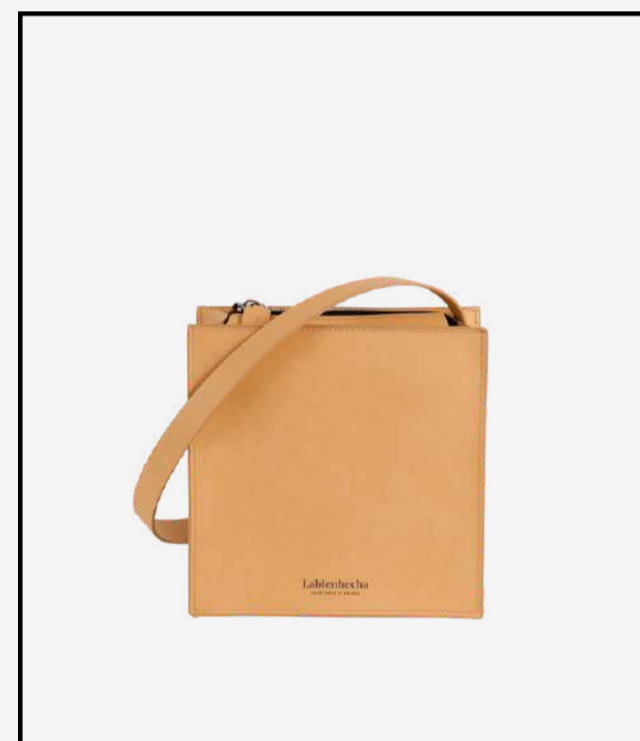

MINIMALIST

SOFÍA (HIJA)

One of the most minimalist, clean models in our collection, bursting with personality. It has been with us since the beginning and still continues to win people's hearts.

DISCOVER

MINIMALIST

SOFÍA (HIJA)

- Zip fastener YKK model
- Two inside pockets
- Finished and painted edges for a greater protection
- One adjustable strap included (140 cm)
- Extra straps available: 60 cm, 70 cm, 80 cm, 100 cm, 120 cm or 140 cm
- Matching accessories

SHOP

EXTRAS

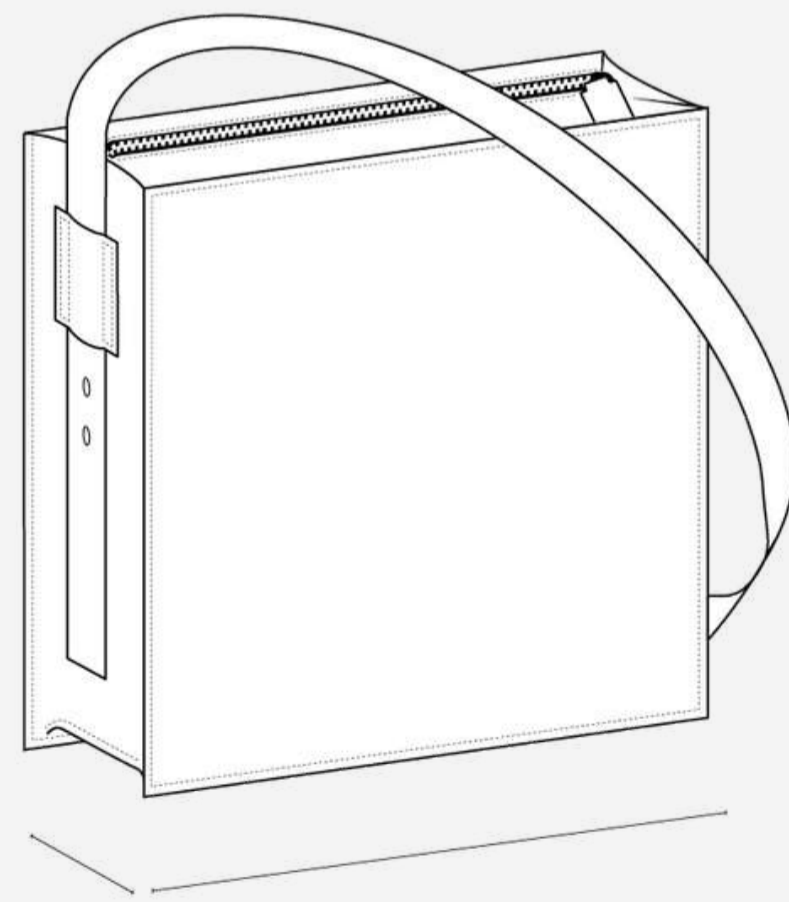

8,5 cm

20 cm

20 cm



BRICK



RED



BOOM BLACK



NUDE



LIGHT-BLUE



WINE



CREAM



TANNED



NAVY



CLOVER GREEN



BIENHECHA BLUE



MAT BLACK



POSITIONS | * The model is 1.70 m tall

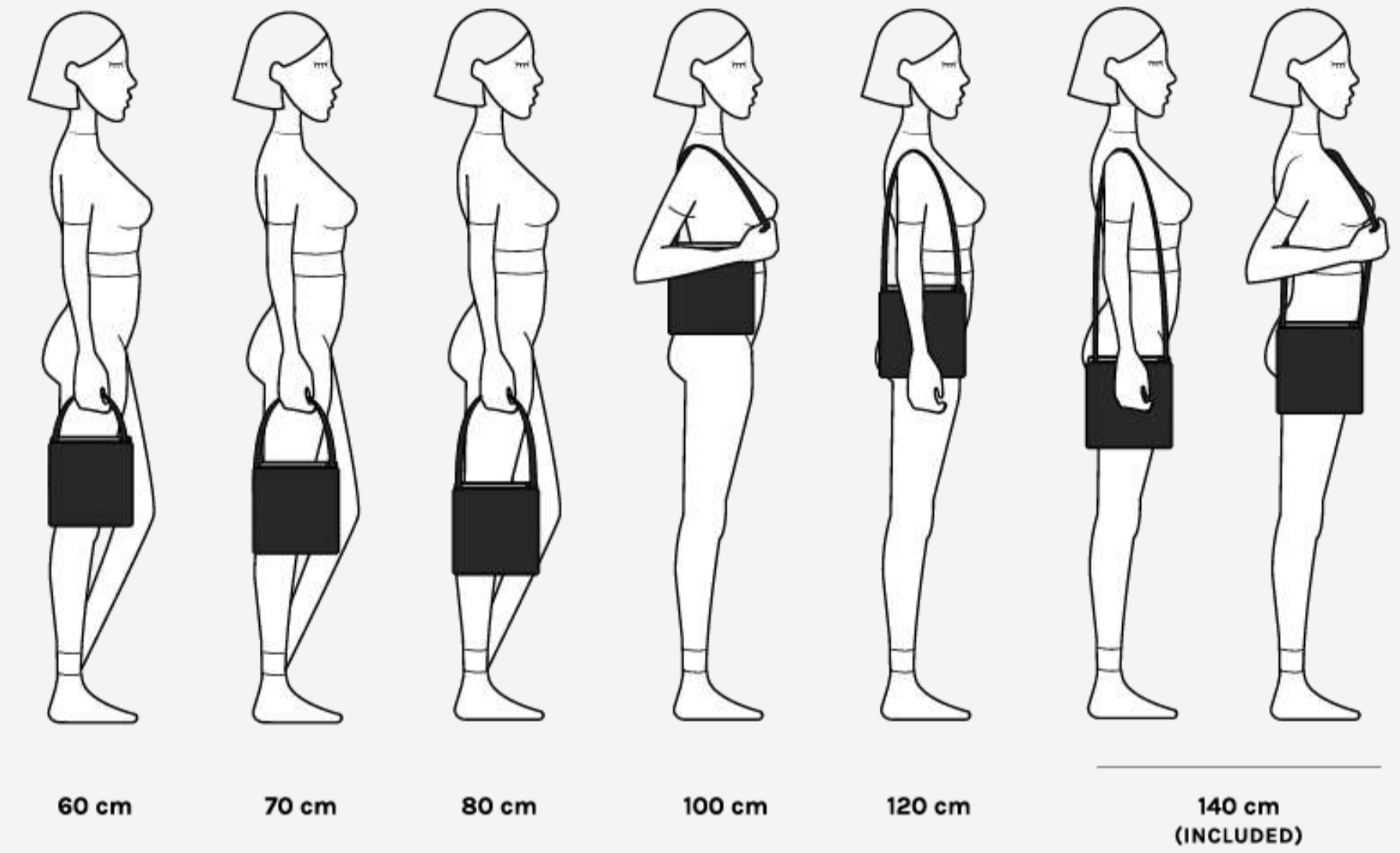

MINIMALIST

SOFÍA (HIJA)

SHOP

RETAIL PRICE: 244,95€

*Sign in to your account to see your wholesale price



EXTRA SPACE

SOFÍA (MADRE)

One of those bags that can do it all. Spacious and structured, the bigger version of Sofía (hija) has been with us since the very beginning. Perfect for those who need extra space.

DISCOVER

EXTRA SPACE

SOFÍA (MADRE)

- Zip fastener YKK model
- Two inside pockets
- Finished and painted edges for a greater protection
- Adjustable strap included (100 cm)
- Extra available straps: 70 cm, 80 cm, 100 cm, 120 cm or 140 cm
- Matching accessories

SHOP

EXTRAS

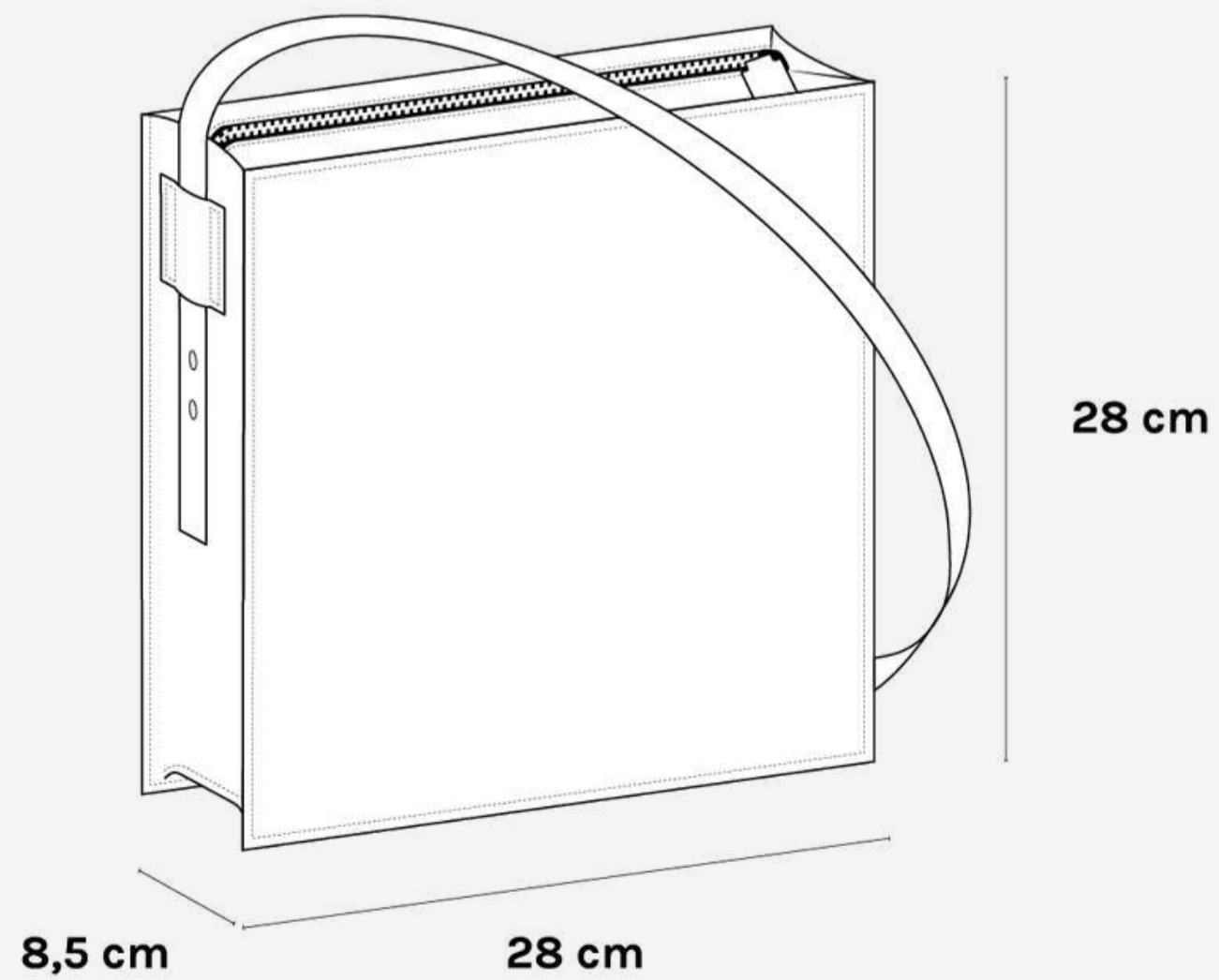

BRICK



RED



BOOM BLACK



NUDE



LIGHT-BLUE



WINE



CREAM



TANNED



NAVY



CLOVER GREEN



BIENHECHA BLUE



MAT BLACK



POSITIONS | * The model is 1.70 m tall

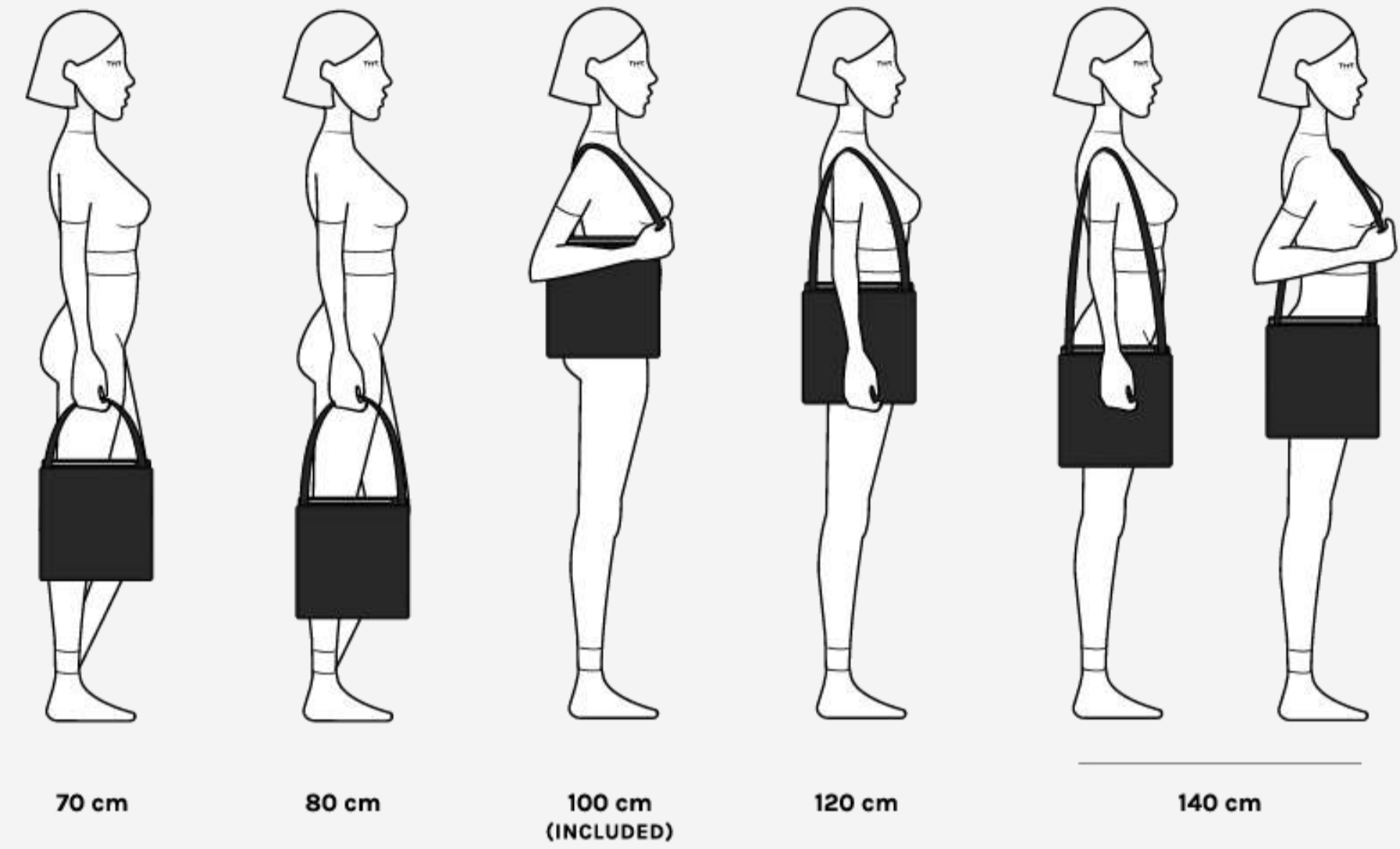

EXTRA SPACE

SOFÍA (MADRE)

SHOP

RETAIL PRICE: 299,95€

*Sign in to your account to see your wholesale price



BEST SELLER

BERNARDITA

A half-moon shaped bag that radiates charm. Its pure and minimalist flap brings a touch of personality to complete any look.

DISCOVER

BEST SELLER

BERNARDITA

- Magnet flat fastener
- Two inside pockets (one of them is a cardholder)
- Finished and painted edges for a greater protection
- One cord-strap included (140 cm)
- Extra cord-straps available: 50 cm, 100 cm, 120 cm or 140 cm
- Matching accessories

SHOP

EXTRAS

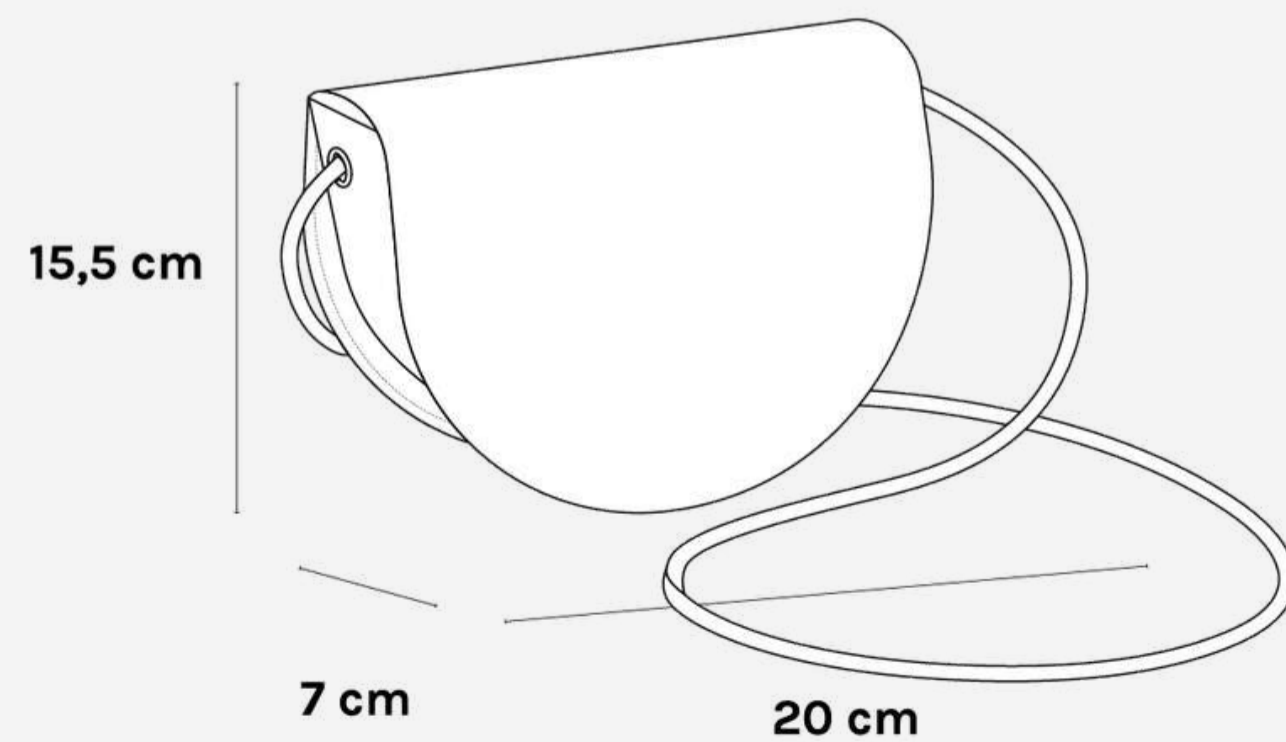

BRICK



RED



BOOM BLACK



NUDE



LIGHT-BLUE



WINE



CREAM



TANNED



NAVY



CLOVER GREEN



BIENHECHA BLUE



MAT BLACK



POSITIONS | * The model is 1.70 m tall



50 cm



100 cm



120 cm



140 cm
(INCLUDED)

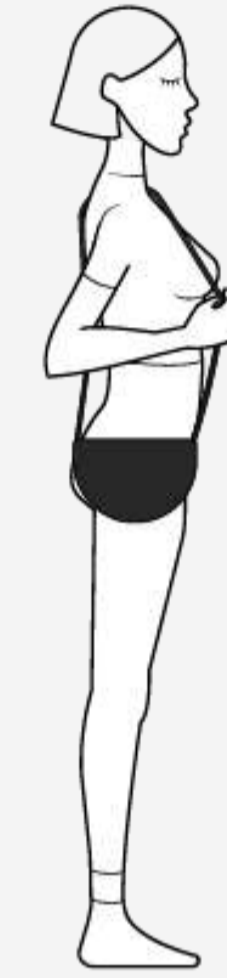

BEST SELLER

BERNARDITA

SHOP

RETAIL PRICE: 219,95€

*Sign in to your account to see your wholesale price

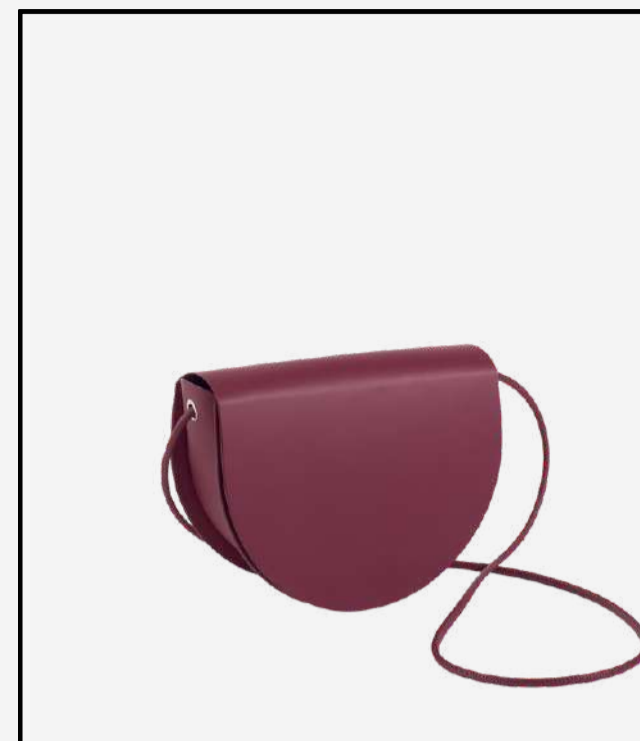

BEST SELLER

BERNARDA

A half-moon shaped bag that radiates charm. Its pure and minimalist flap brings a touch of personality to complete any look. Bernardita's big sister.

DISCOVER

BEST SELLER

BERNARDA

- Magnet flap fastener
- Two inside pockets (one of them is a cardholder)
- Finished and painted edges for a greater protection
- One cord-strap included (140 cm)
- Extra cord-straps available: 50 cm, 100 cm, 120 cm or 140 cm
- Matching accessories

SHOP

EXTRAS

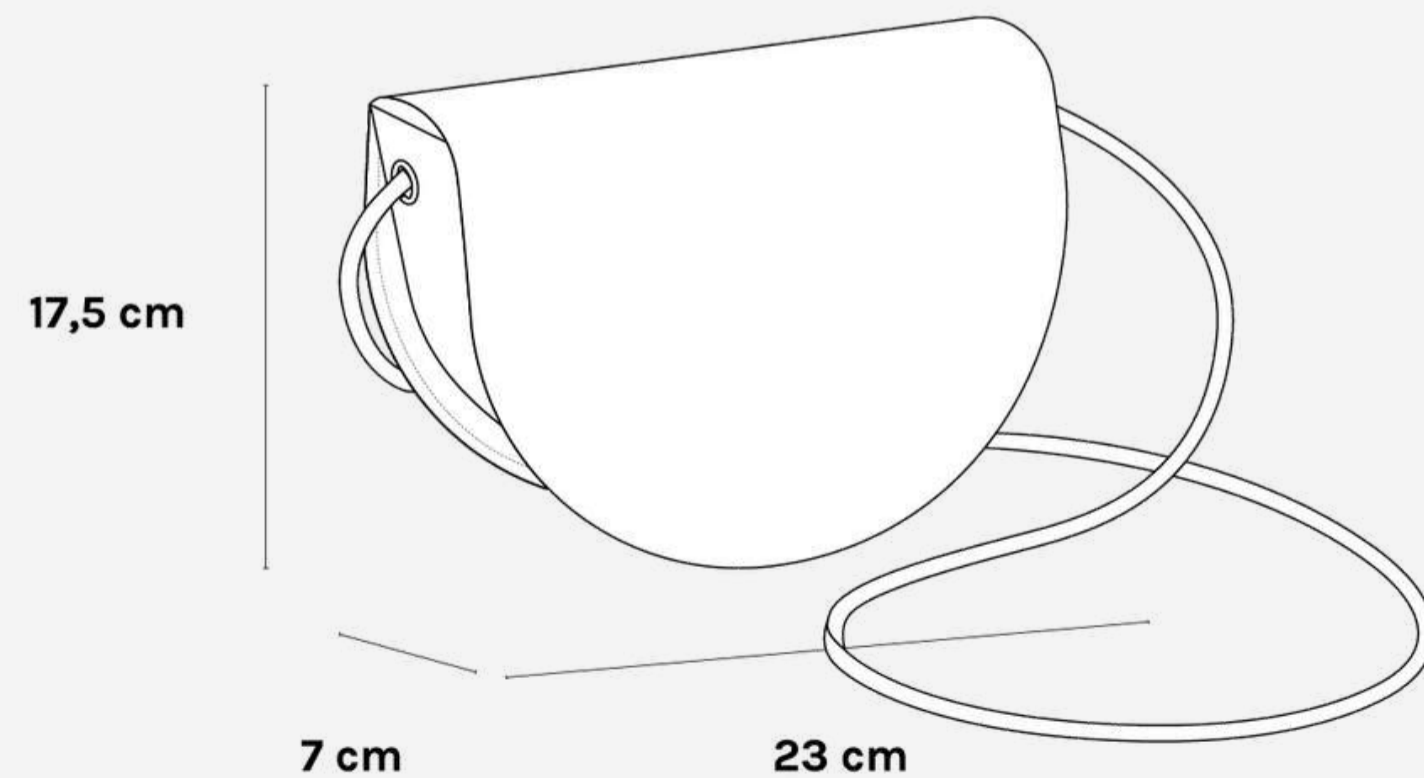

BRICK



RED



BOOM BLACK



NUDE



LIGHT-BLUE



WINE



CREAM



TANNED



NAVY



CLOVER GREEN



BIENHECHA BLUE



MAT BLACK



POSITIONS | * The model is 1.70 m tall



50 cm



100 cm



120 cm



140 cm
(INCLUDED)



BEST SELLER

BERNARDA

SHOP

RETAIL PRICE: 239,95€

*Sign in to your account to see your wholesale price

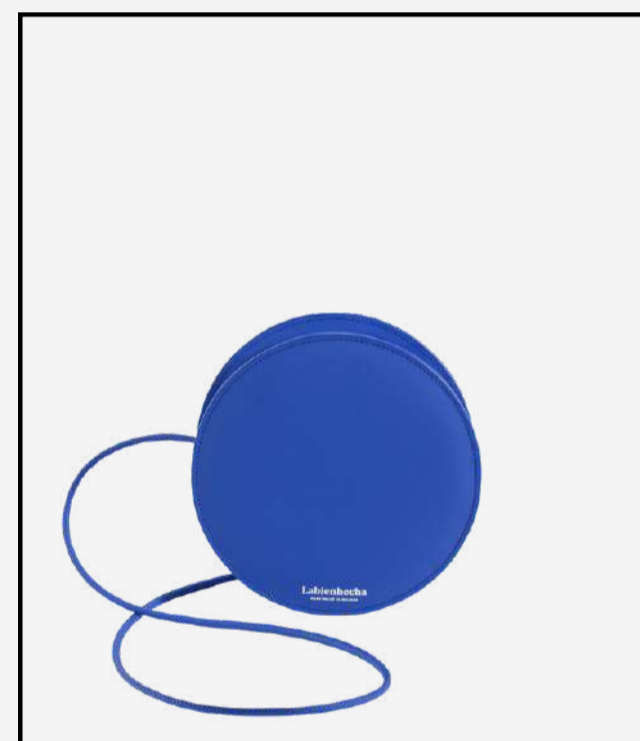

A LITTLE GEM

MARCELINA

A small size bag to carry the essentials.
Its perfectly round shape makes it very special.
We are always told it is a collector's bag.

DISCOVER

A LITTLE GEM

MARCELINA

- Zip fastener YKK model (very soft one)
- One inside pocket
- Finished and painted edges for a greater protectionn
- One cord-strap included (140 cm)
- Extra cord-straps available: 50 cm, 100 cm, 120 cm or 140 cm
- Matching accessories

SHOP

EXTRAS

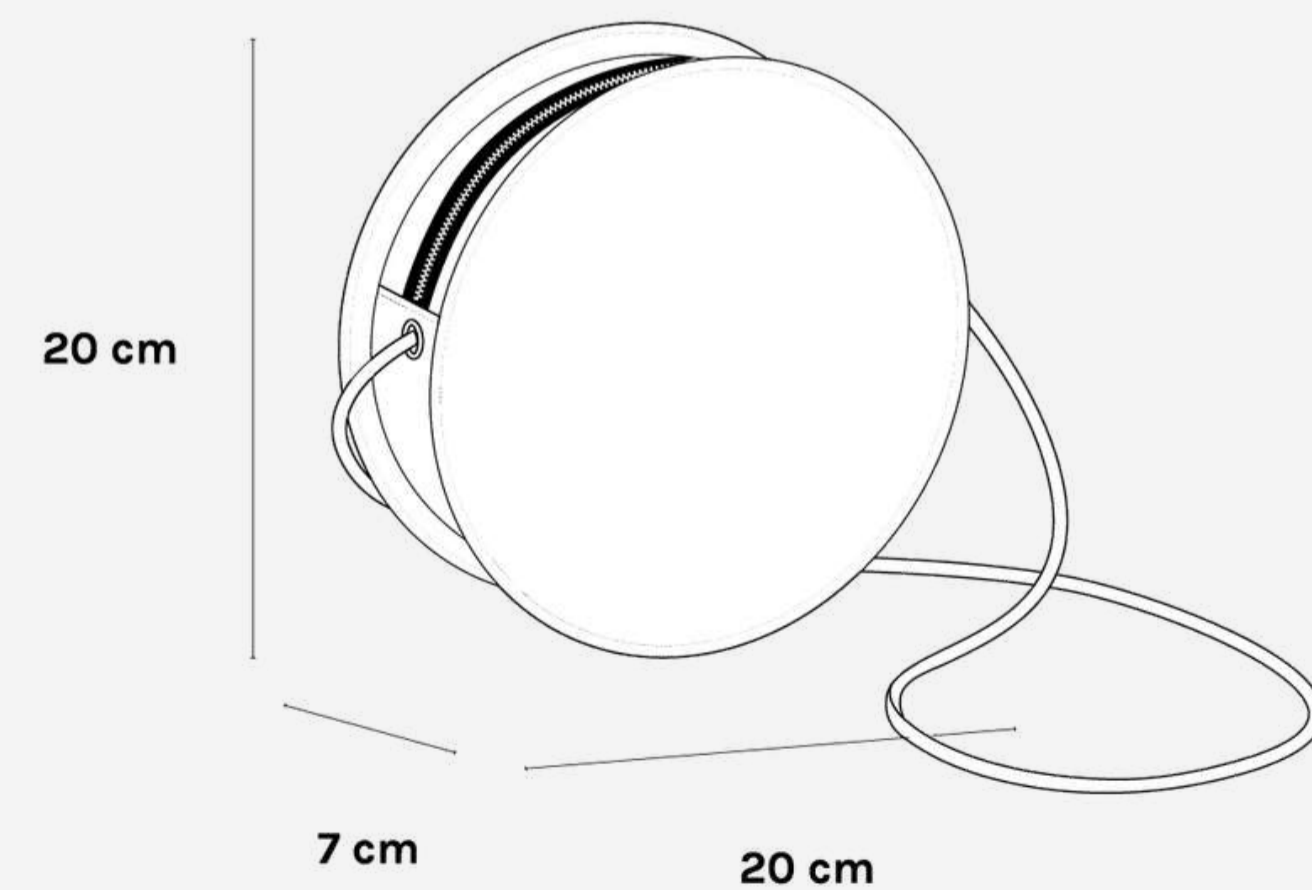

BRICK

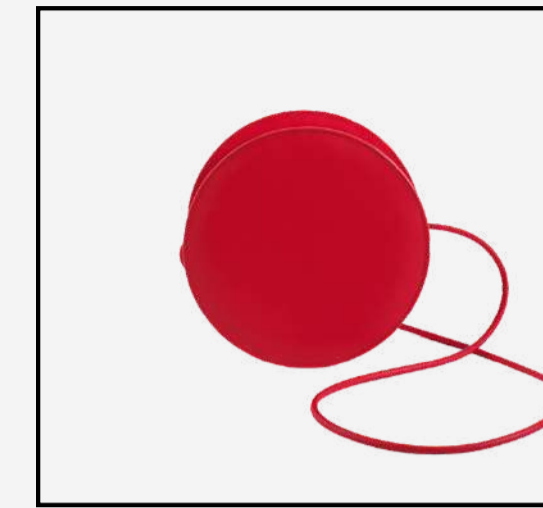

RED

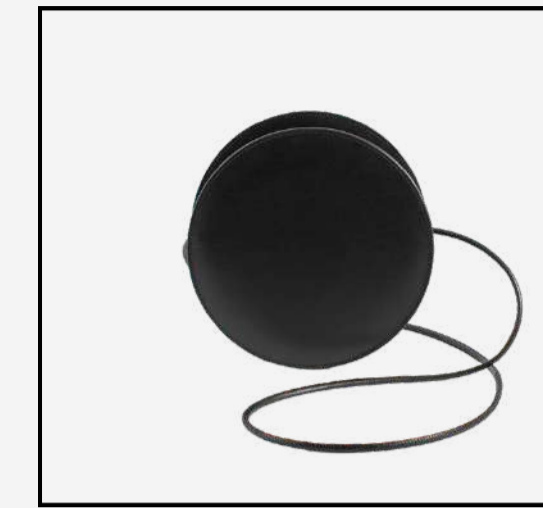

BOOM BLACK

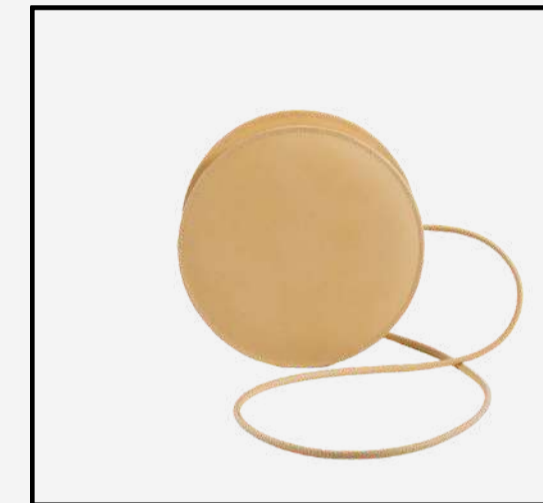

NUDE

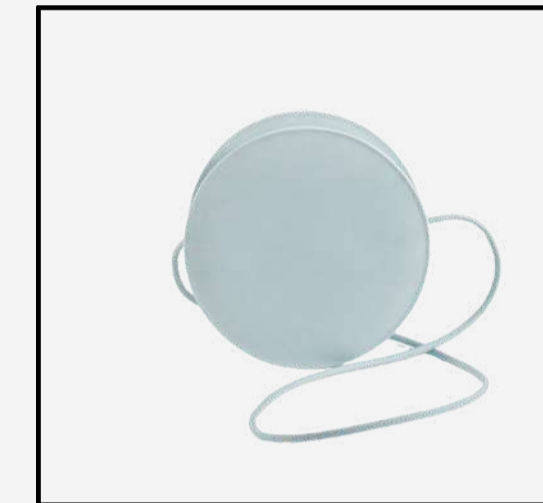

LIGHT-BLUE

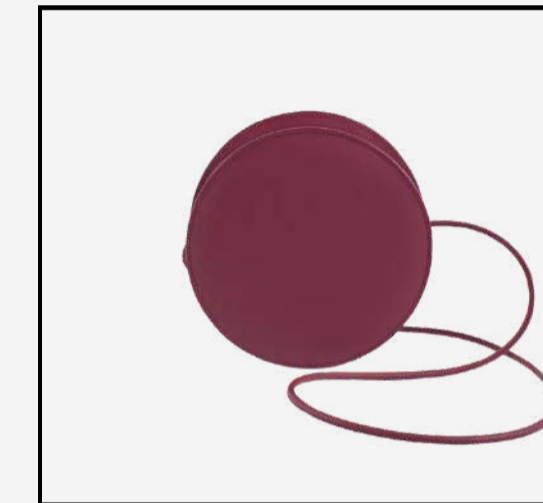

WINE



CREAM



TANNED



NAVY

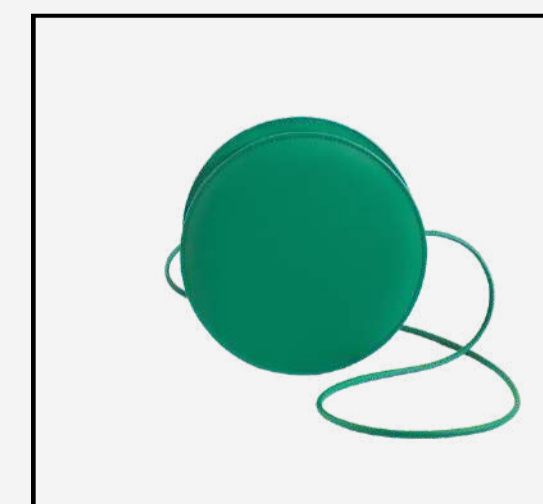

CLOVER GREEN



BIENHECHA BLUE



MAT BLACK



POSITIONS | * The model is 1.70 m tall



50 cm



100 cm



120 cm



140 cm
(INCLUDED)

A LITTLE GEM

MARCELINA

SHOP

RETAIL PRICE: 269,95€

*Sign in to your account to see your wholesale price

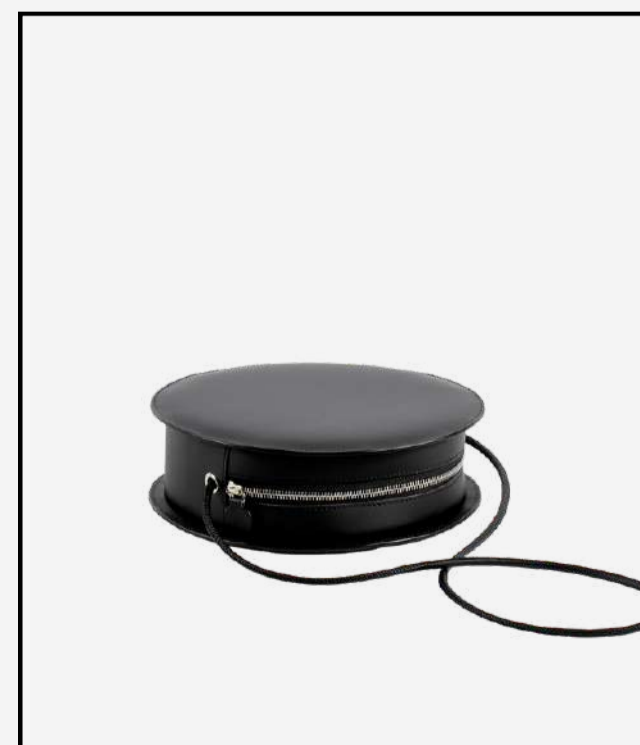
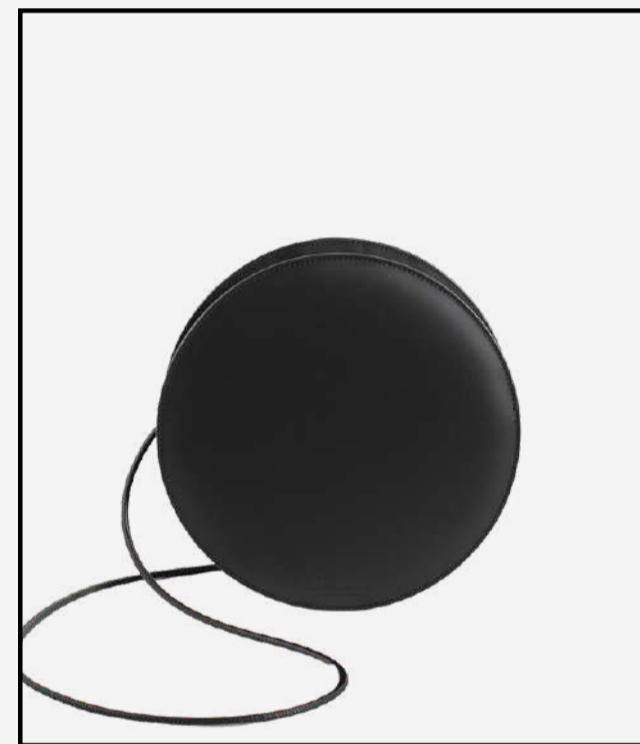

A GEM

MARCELA

A medium-sized bag to carry the essentials. Its completely circular shape makes it very special. We are always told that it is a collector's bag. Marcelina's big sister.

DISCOVER

A GEM

MARCELA

- Zip fastener YKK model (very soft one)
- One inside pocket
- Finished and painted edges for a greater protection
- One cord-strap included (140 cm)
- Extra cord-straps available: 50 cm, 100 cm, 120 cm or 140 cm
- Matching accessories

SHOP

EXTRAS

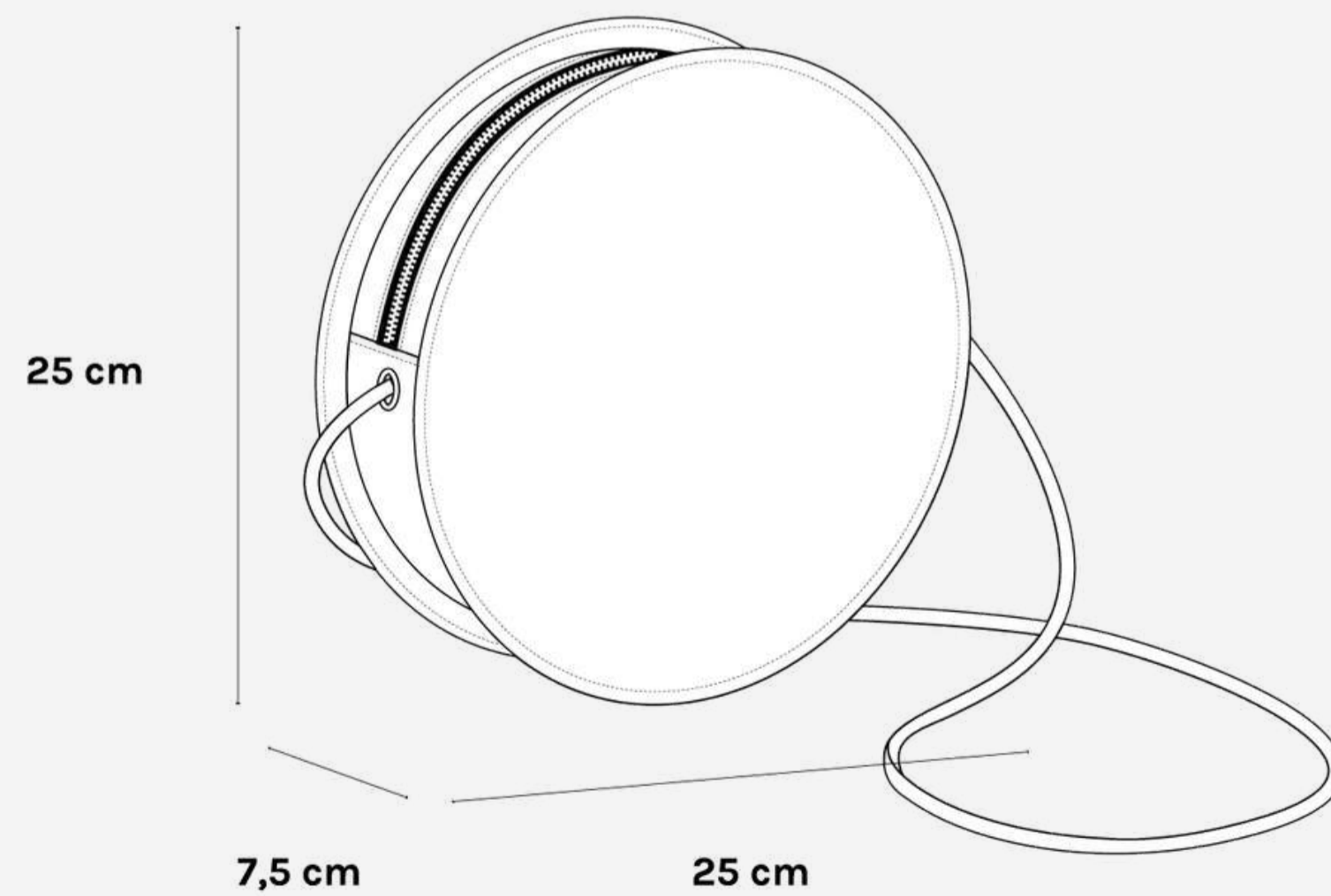

BRICK



RED

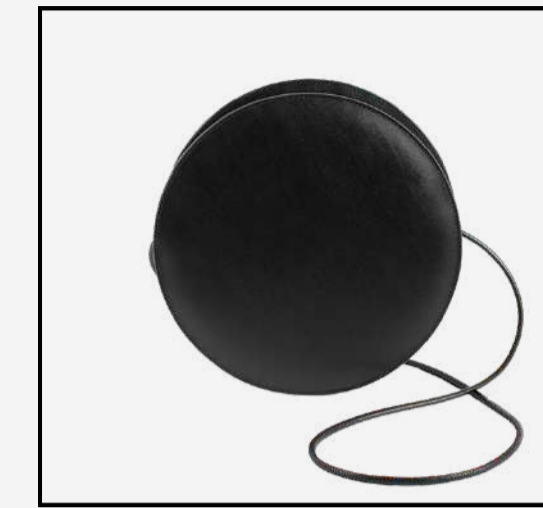

BOOM BLACK



NUDE

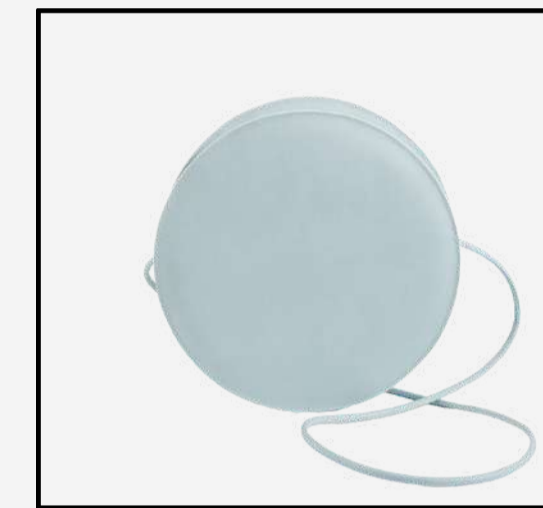

LIGHT-BLUE

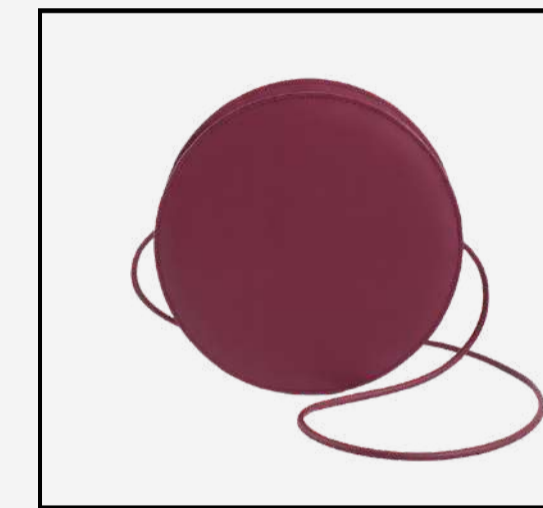

WINE



CREAM



TANNED



NAVY



CLOVER GREEN

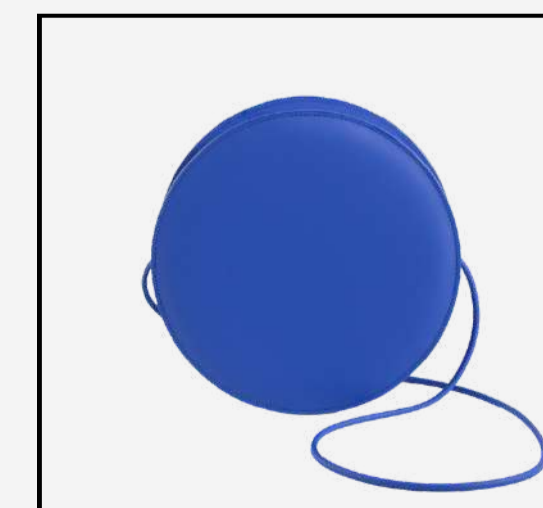

BIENHECHA BLUE



MAT BLACK



POSITIONS | * The model is 1.70 m tall



50 cm



100 cm



120 cm

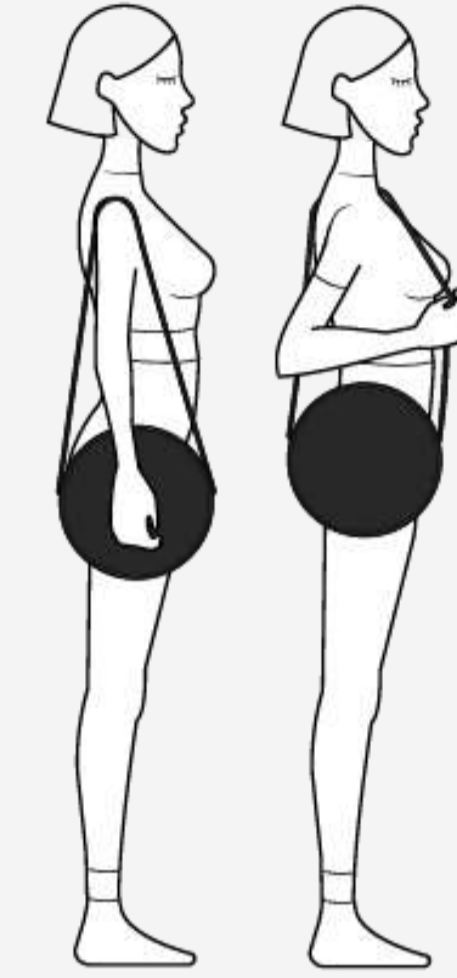

140 cm
(INCLUDED)

A GEM

MARCELA

SHOP

RETAIL PRICE: 299,95€

*Sign in to your account to see your wholesale price

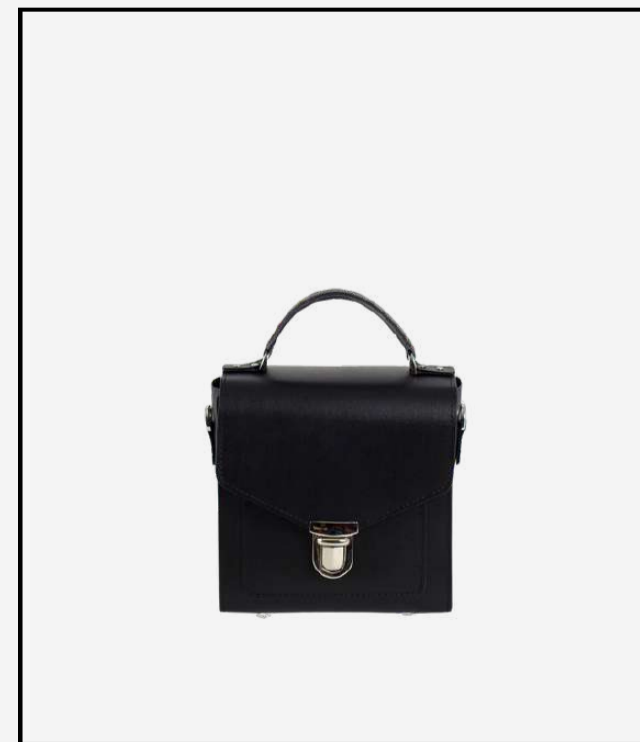
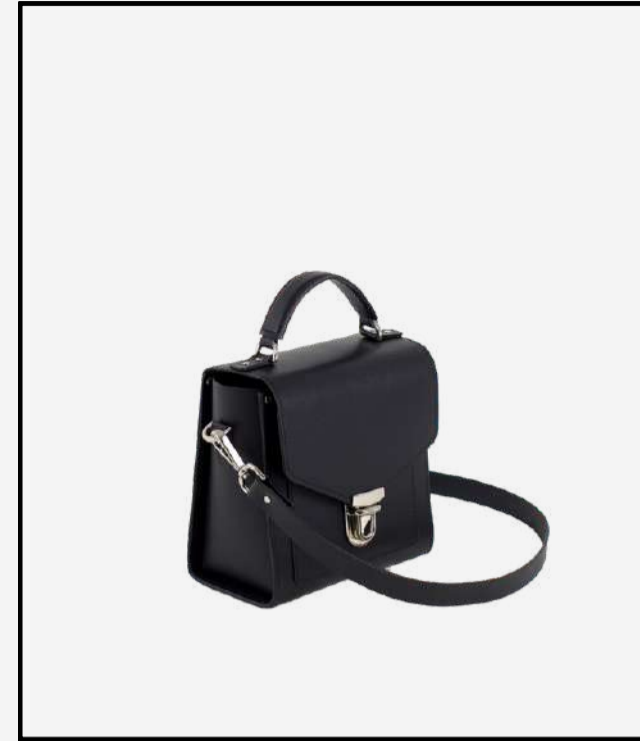

BEST SELLER

RAMONA

One of the jewels in the crown. One of the most desired. Available in all colours and in two sizes. Extra options.

DISCOVER

BEST SELLER

RAMONA

- Buckle flap fastener
- Two inside pockets (one of them is a cardholder)
- Finished and painted edges for a greater protection
- Reinforced base and flap to keep its shape
- Nickle free metal trimmings in the bas
- One carabiner strap included (120 cm)
- Extra straps available

SHOP

EXTRAS

LA GRANDE

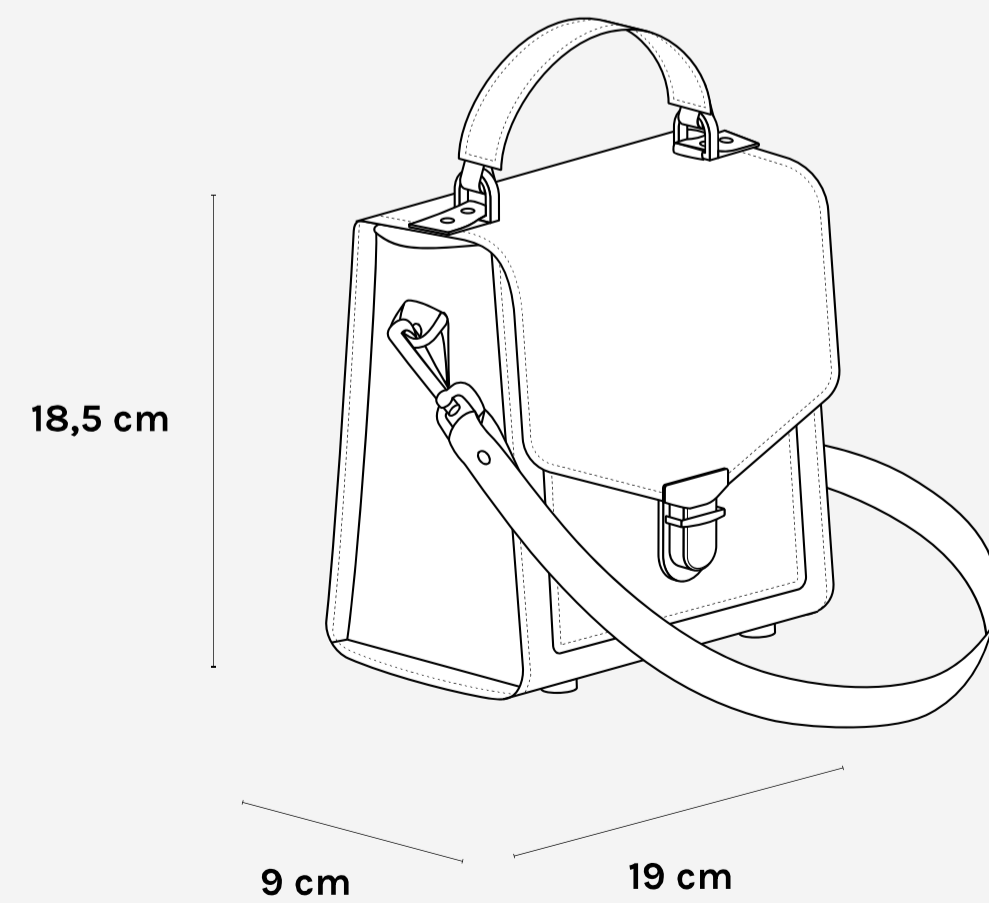

LA CHICA

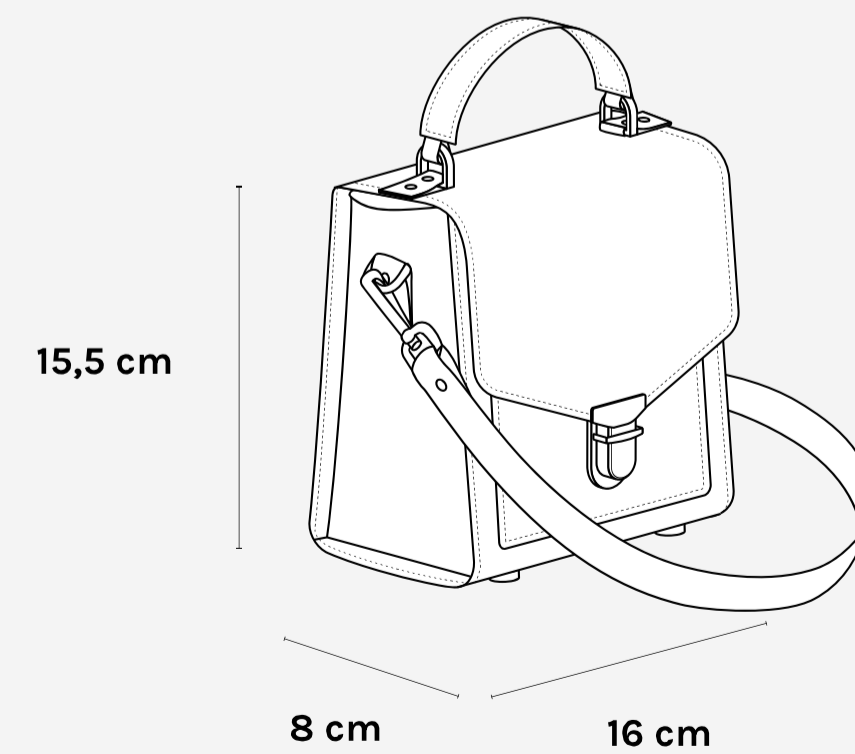

BRICK

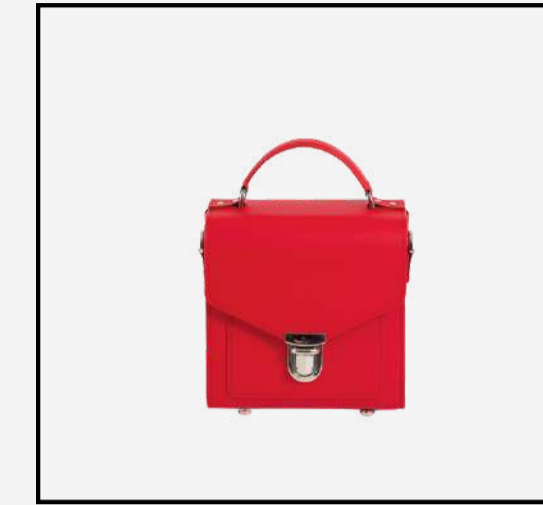

RED



BOOM BLACK



NUDE



LIGHT-BLUE



WINE



CREAM



TANNED



NAVY

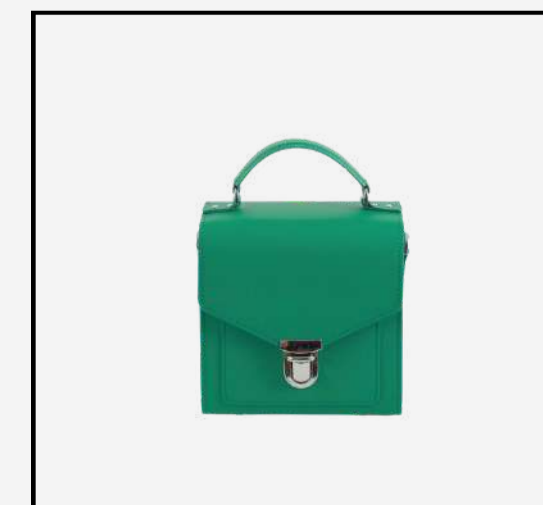

CLOVER GREEN

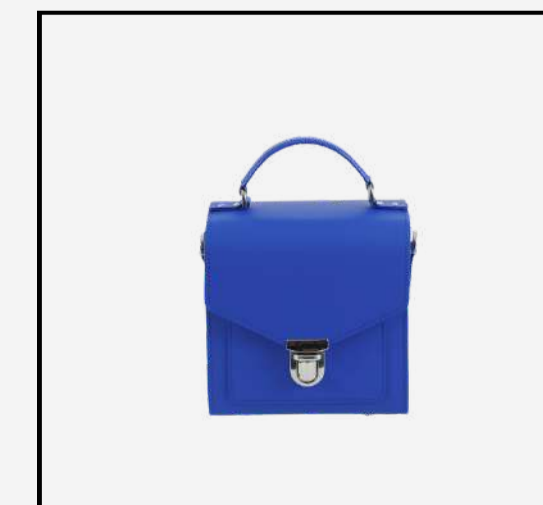

BIENHECHA BLUE



MAT BLACK



POSITIONS | * The model is 1.70 m tall

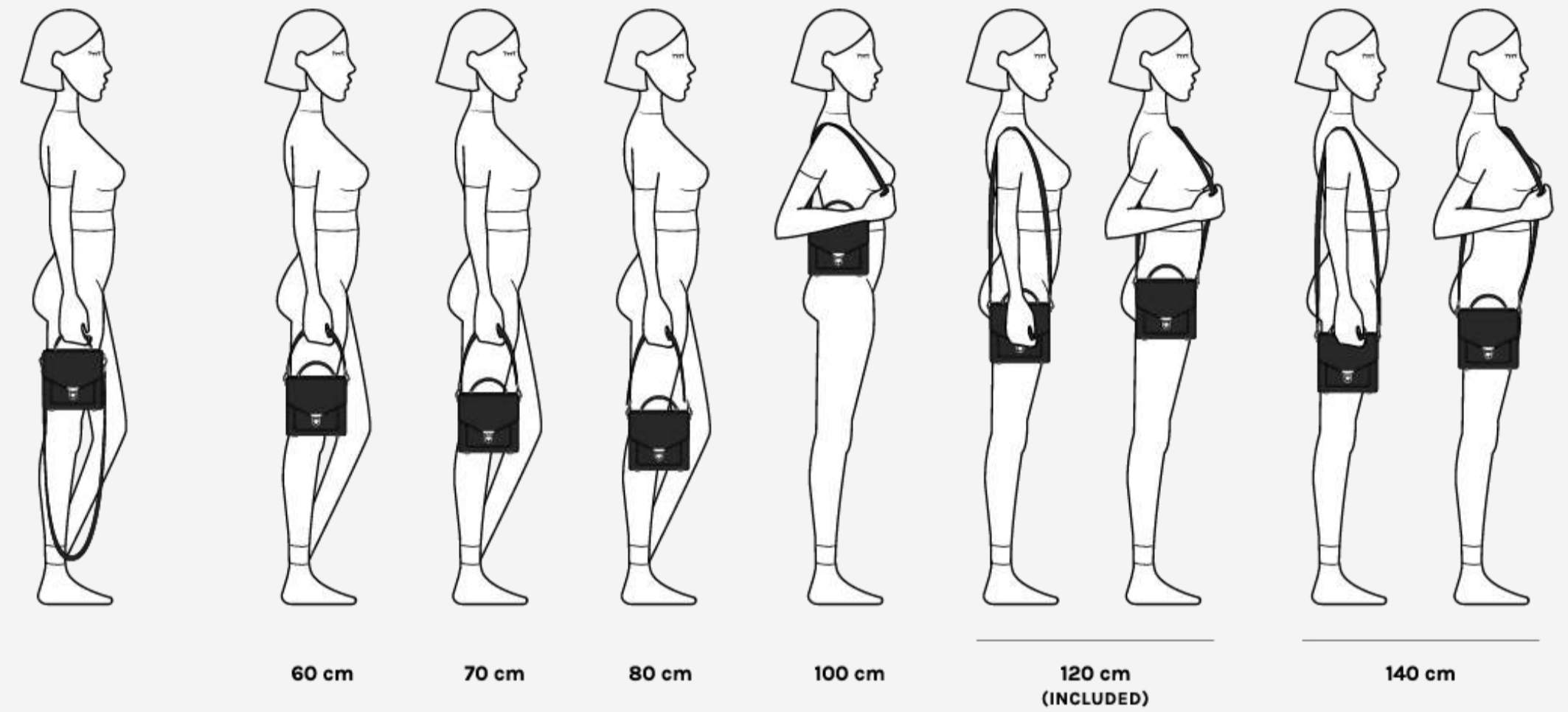

BEST SELLER

RAMONA (THE SMALL ONE)

SHOP

RETAIL PRICE: 299,95€

*Sign in to your account to see your wholesale price



POSITIONS | * The model is 1.70 m tall

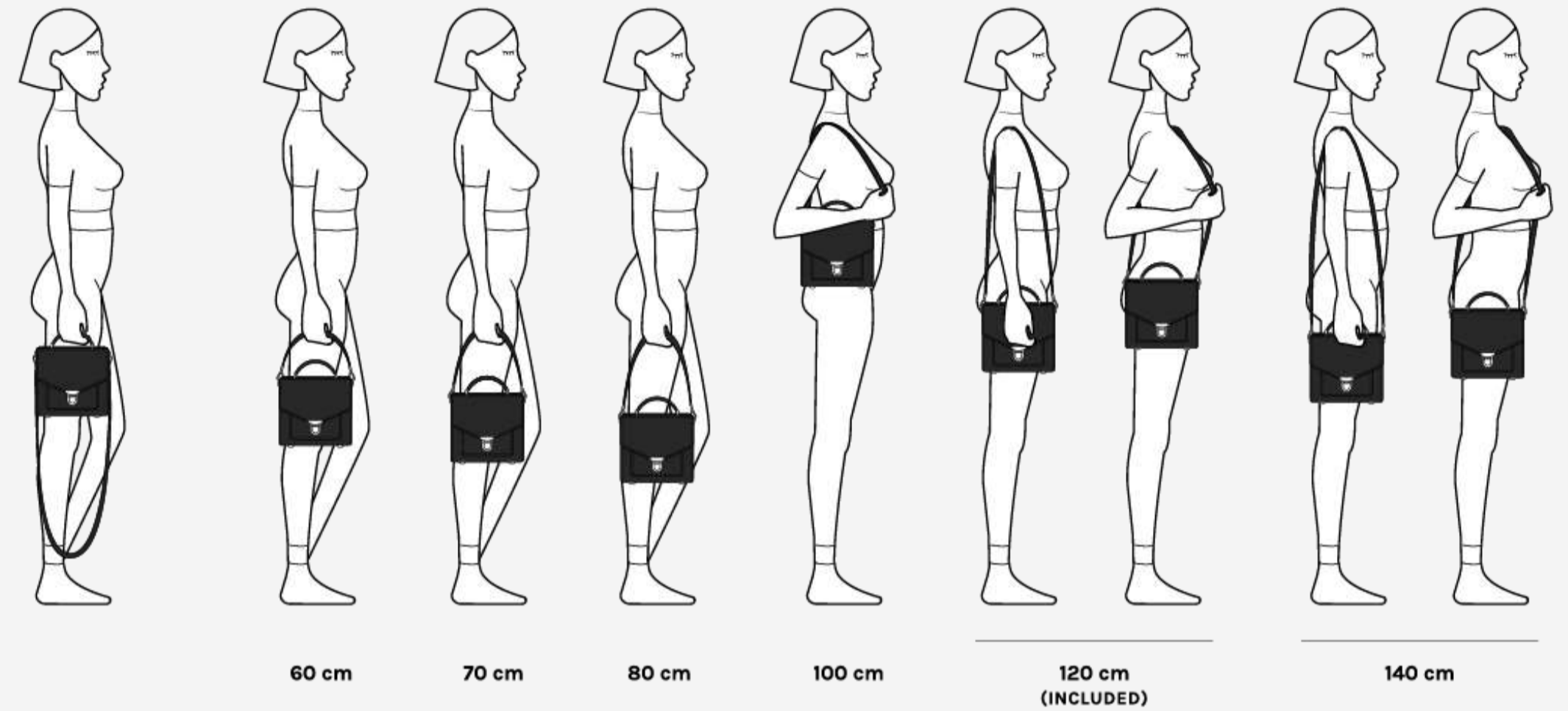

BEST SELLER

RAMONA (THE BIG ONE)

SHOP

RETAIL PRICE: 329,95€

*Sign in to your account to see your wholesale price

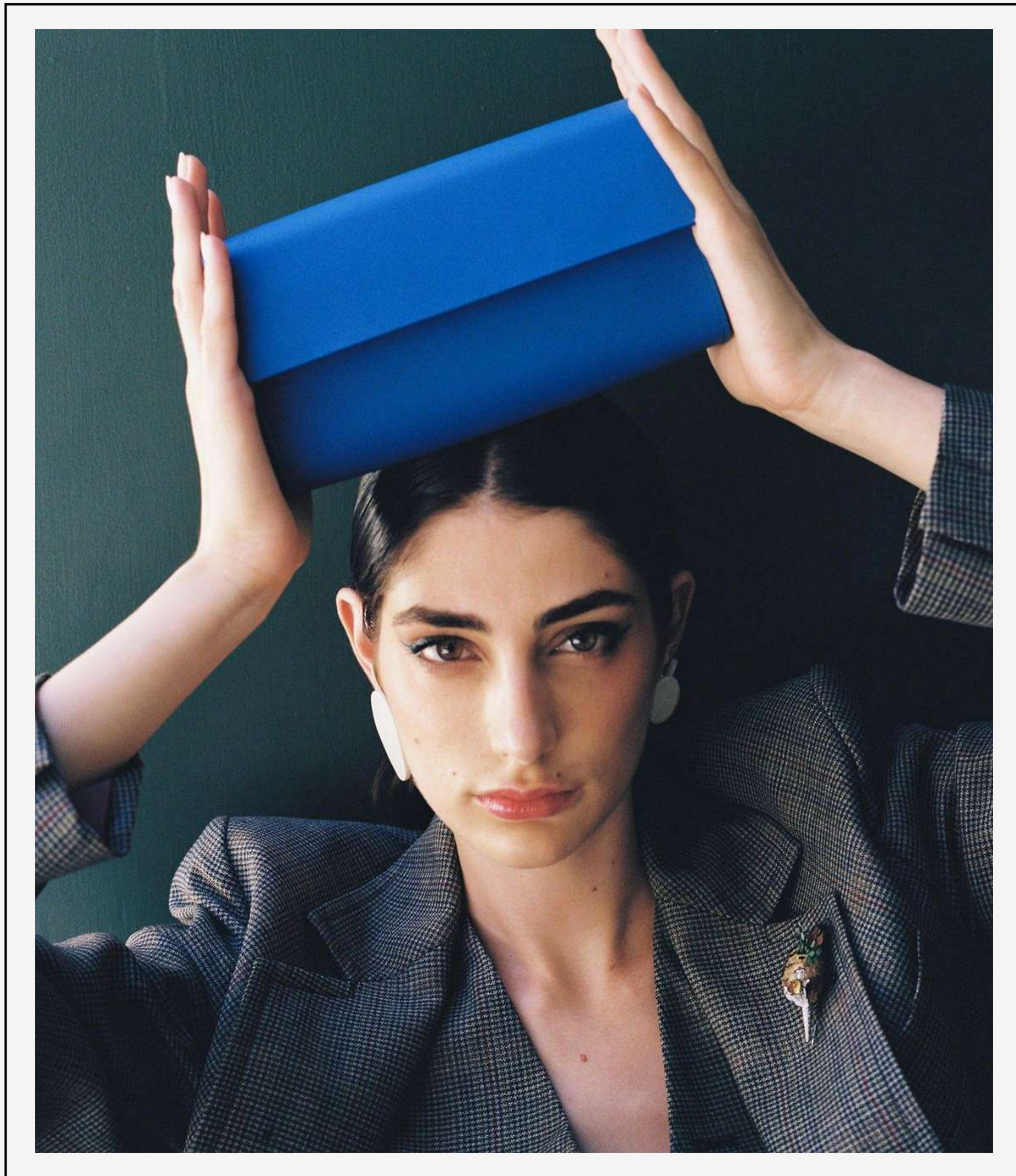

THE BELT BAG / CLUTCH

LOLA (THE ELDER ONE)

Lola is one of our most iconic models. A multi-use 3 in 1 bag. It can be worn as a clutch, as a belt bag (by adding a belt) or as a shoulder bag.

DISCOVER

THE BELT BAG / CLUTCH

LOLA (THE ELDER ONE)

- Double magnet flap fastener
- Two inside pockets (one of them is a cardholder)
- Finished and painted edges for a greater protection
- Possibility of adding a 120 cm or 140 cm belt
- Matching accessories

SHOP

EXTRAS

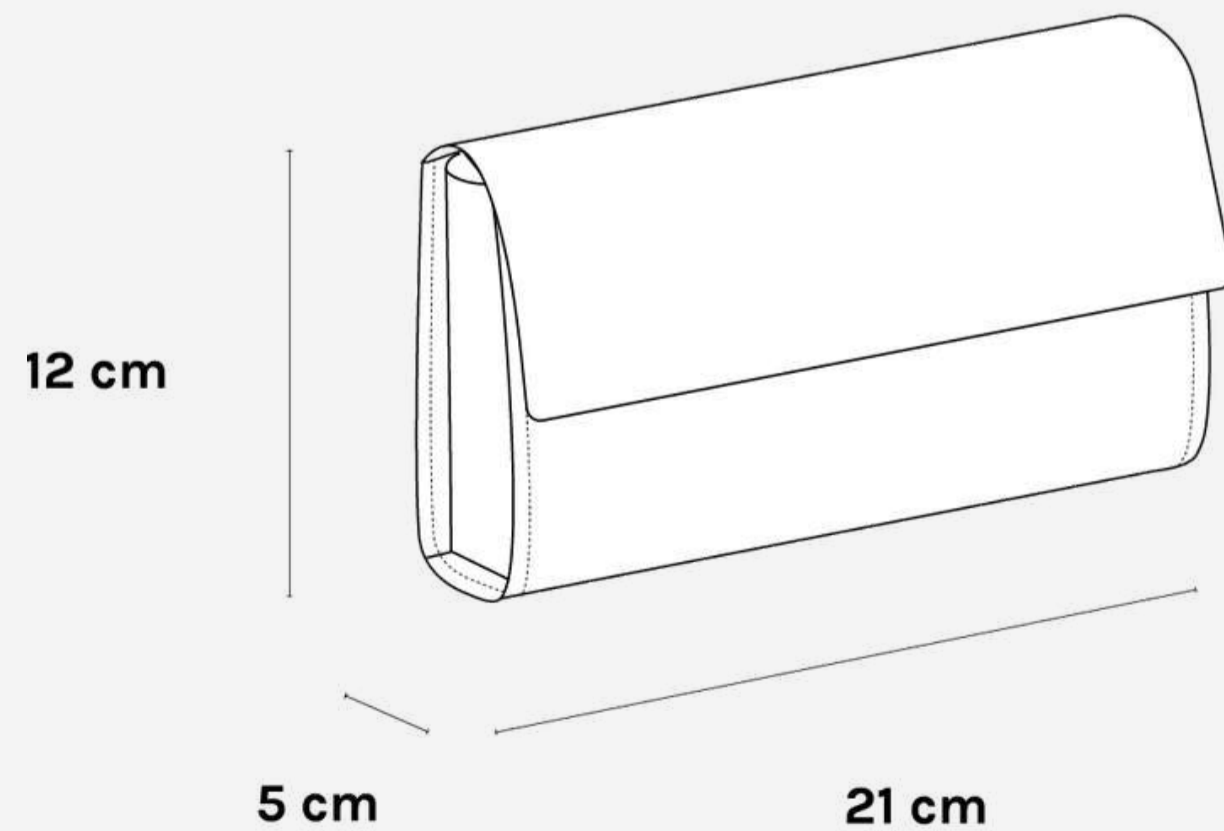

BRICK

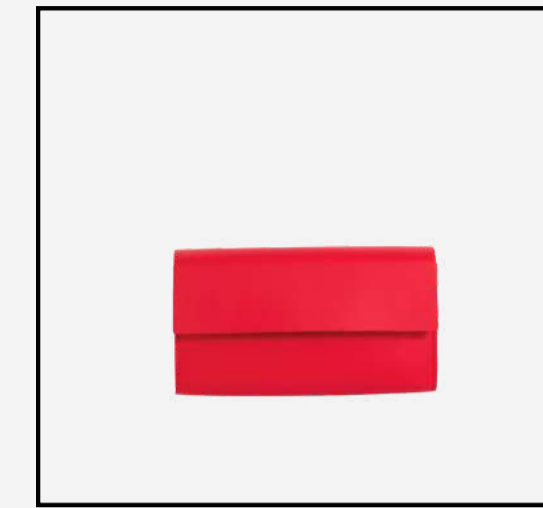

RED



BOOM BLACK

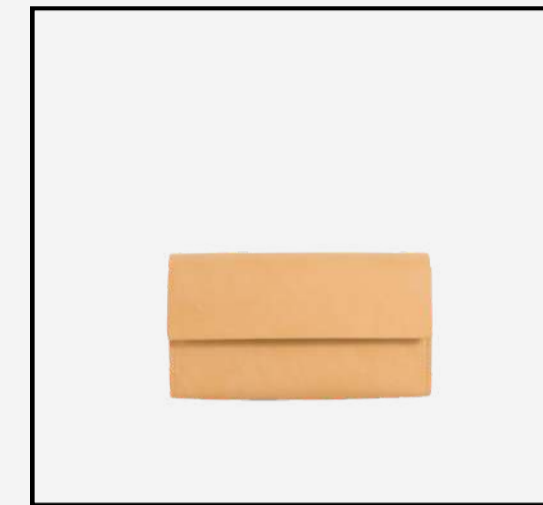

NUDE

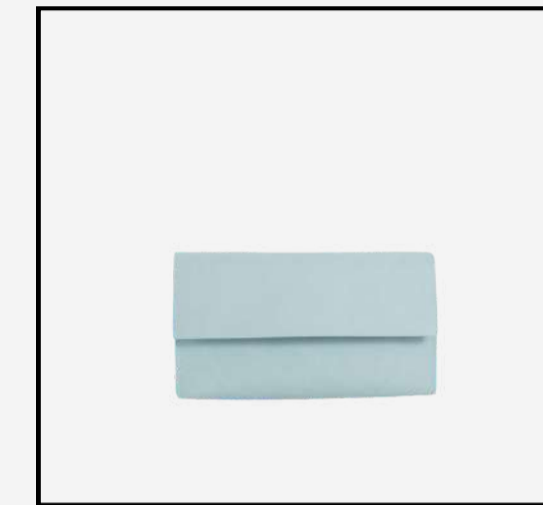

LIGHT-BLUE



WINE



CREAM



TANNED



NAVY

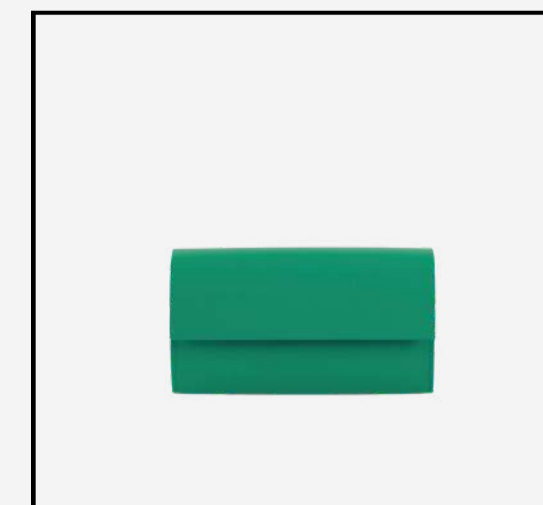

CLOVER GREEN

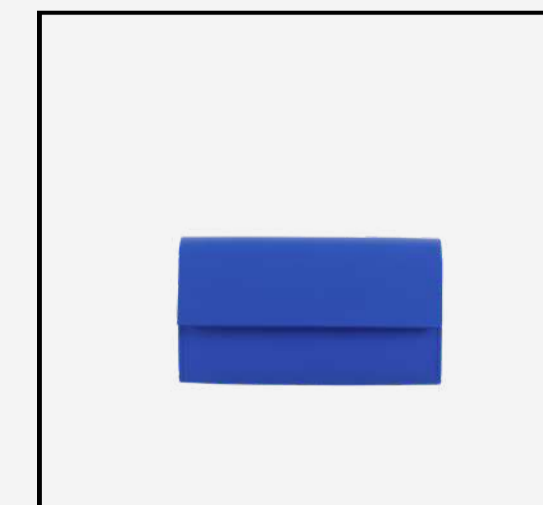

BIENHECHA BLUE



MAT BLACK



POSITIONS | * The model is 1.70 m tall

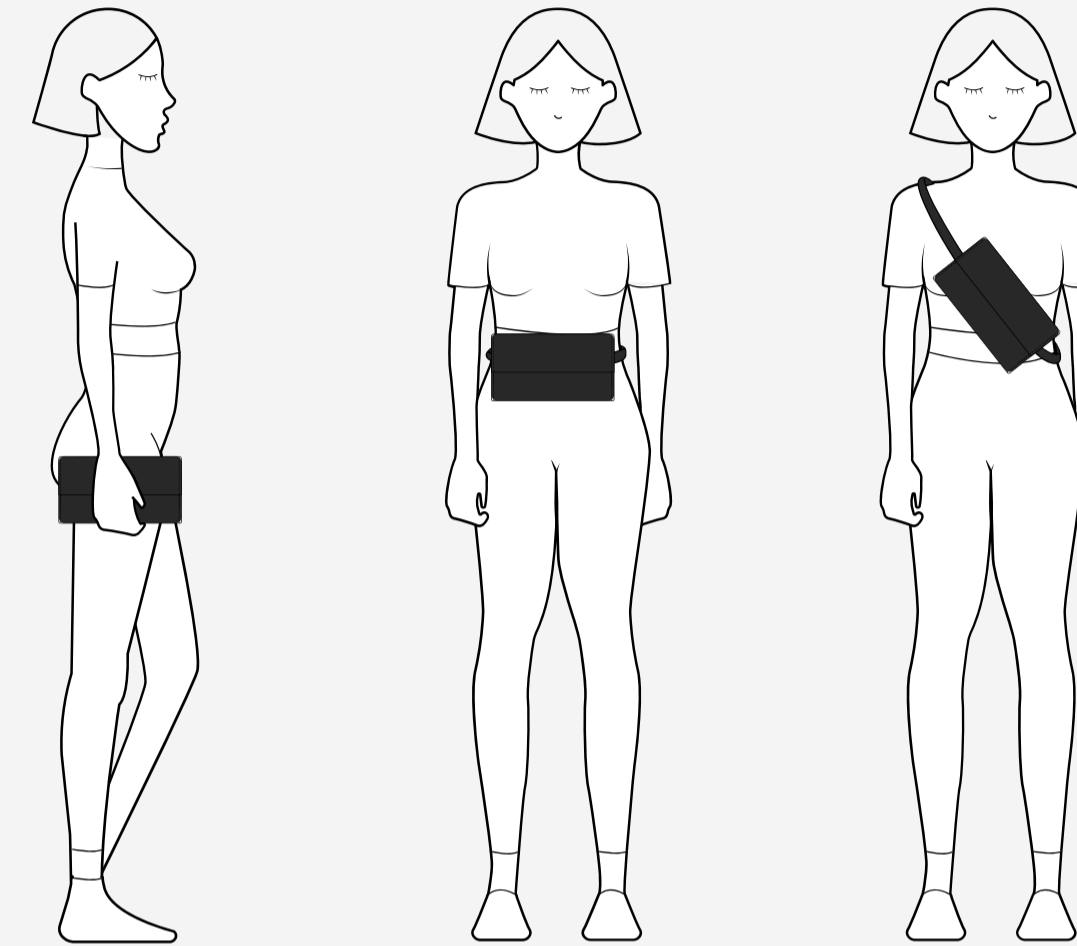

120 cm

140 cm

THE BELT BAG / CLUTCH

LOLA (THE ELDER ONE)

SHOP

RETAIL PRICE: 159,95€

*Sign in to your account to see your wholesale price



SPACIOUS & MINIMALIST

ENCARNITA (THE ELDER ONE)

One of the most minimalist and pure, yet superspacious and comfortable at the same time. Medium sized and very well structured with an impeccable finish.

DISCOVER

SPACIOUS & MINIMALIST

ENCARNITA (THE ELDER ONE)

- Magnet flap fastener
- One inside pocket
- Finished and painted edges for a greater protection
- One cord-strap included (140 cm)
- Extra cord-straps available: 50 cm, 100 cm, 120 cm or 140 cm
- Matching accessories

SHOP

EXTRAS

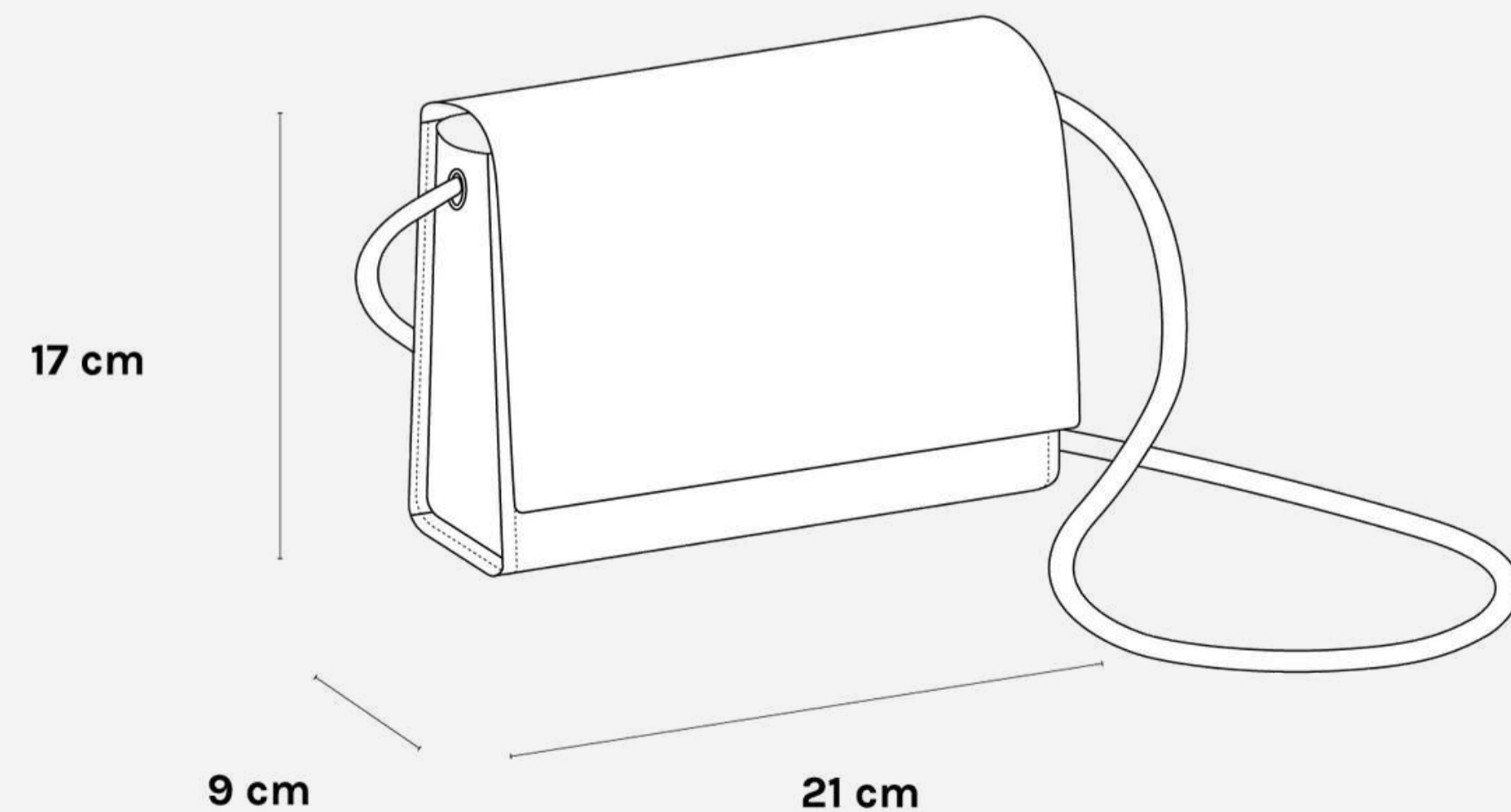

BRICK



RED



BOOM BLACK



NUDE



LIGHT-BLUE



WINE



CREAM



TANNED



NAVY



CLOVER GREEN

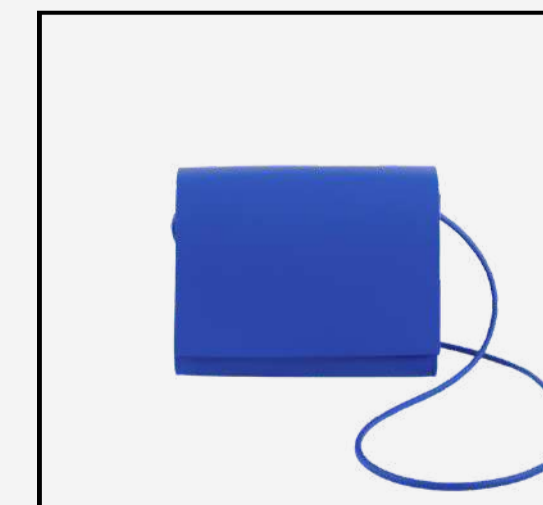

BIENHECHA BLUE



MAT BLACK



POSITIONS | * The model is 1.70 m tall



50 cm



100 cm



120 cm

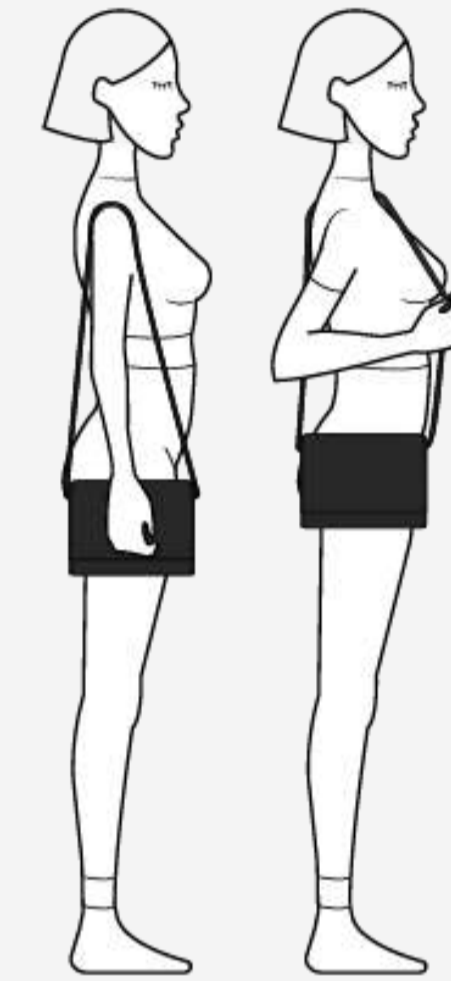

140 cm
(INCLUDED)

SPACIOUS & MINIMALIST

ENCARNITA (THE ELDER ONE)

SHOP

RETAIL PRICE: 169,95€

*Sign in to your account to see your wholesale price

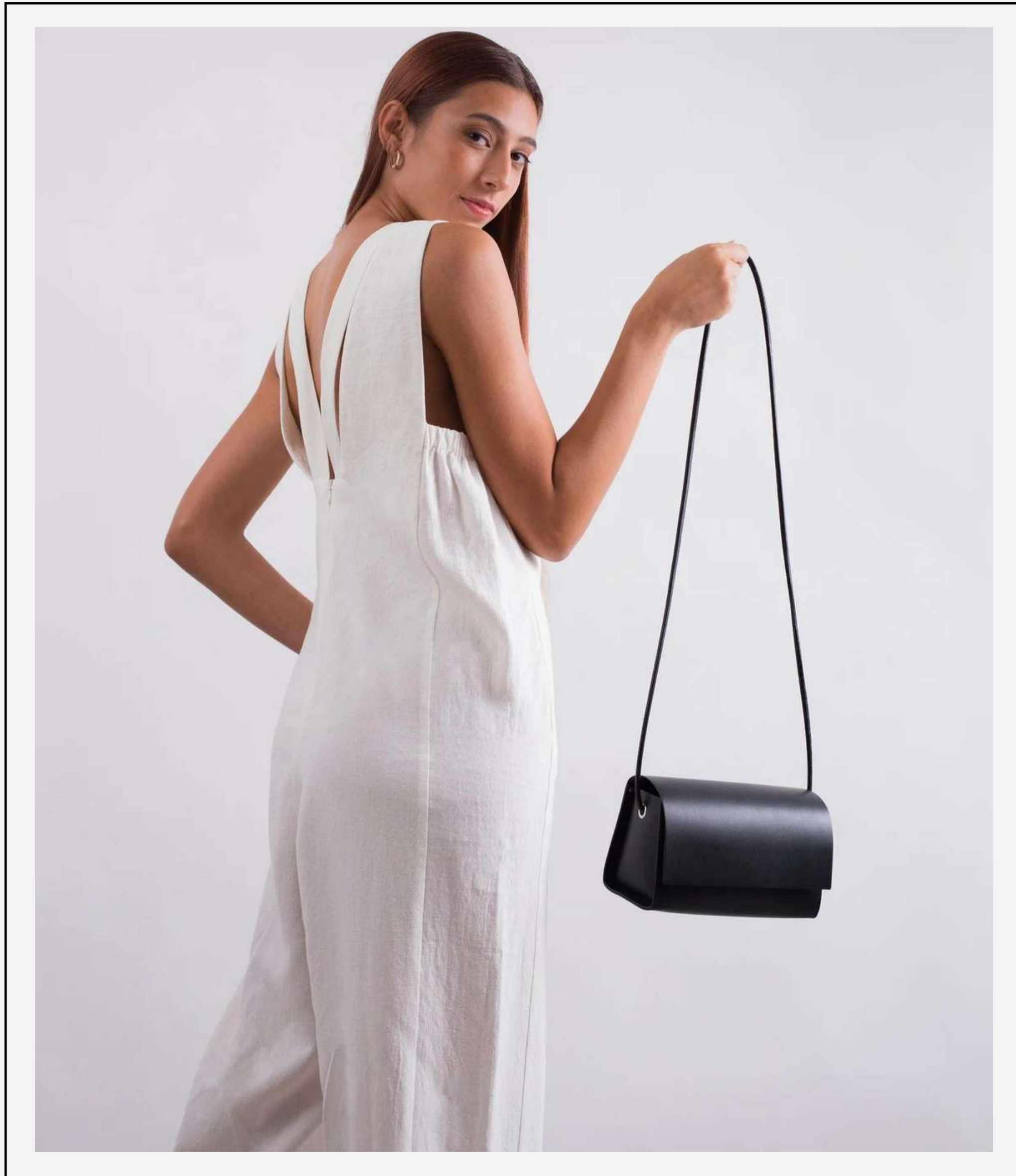

EXTRA SPACIOUS

AMPARITO (THE ELDER ONE)

A versatile, spacious bag with the ideal size. You will be surprised by Amparito's capacity and the convenience of having everything at hand thanks to its wide size.

DISCOVER

EXTRA SPACIOUS

AMPARITO (THE ELDER ONE)

- Magnet flap fastener
- One inside pocket
- Finished and painted edges for a greater protection
- One cord-strap included (140 cm)
- Extra cord-straps available: 50 cm, 100 cm, 120 cm or 140 cm
- Matching accessories

SHOP

EXTRAS

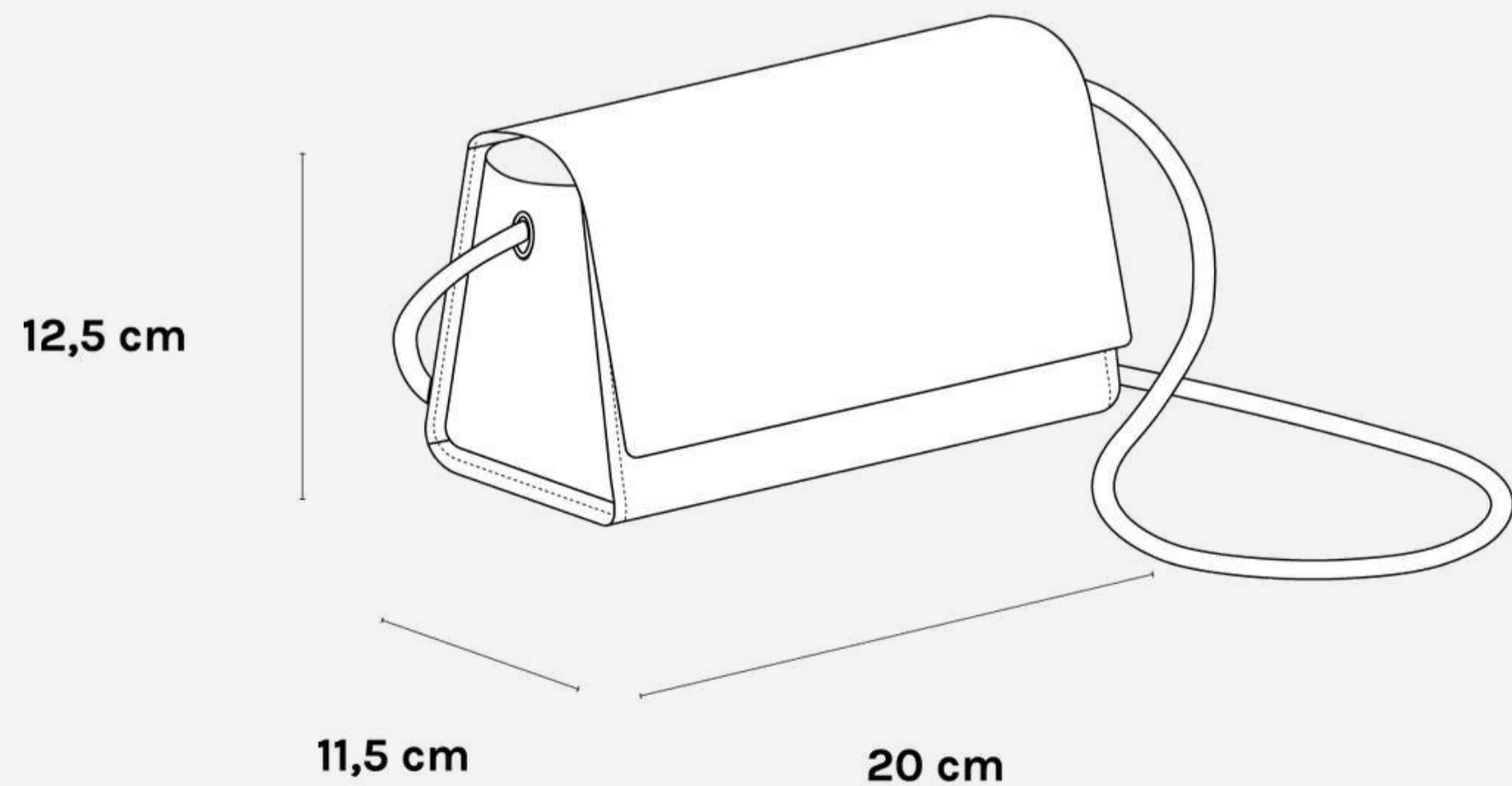

BRICK



RED



BOOM BLACK



NUDE

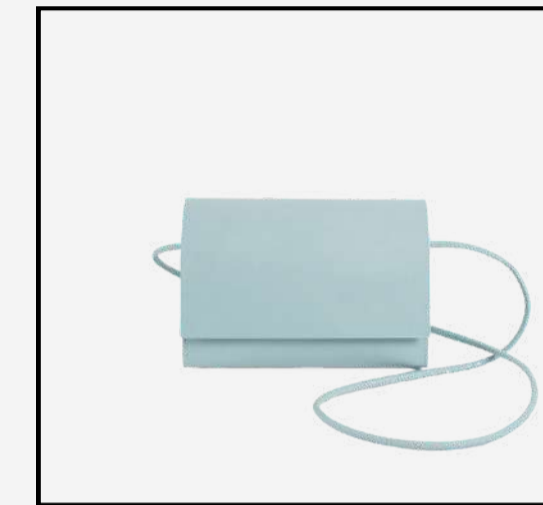

LIGHT-BLUE



WINE



CREAM



TANNED



NAVY

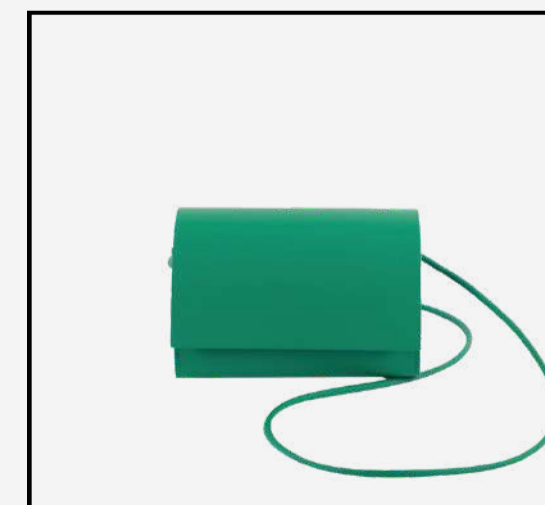

CLOVER GREEN



BIENHECHA BLUE



MAT BLACK



POSITIONS | * The model is 1.70 m tall



50 cm



100 cm



120 cm

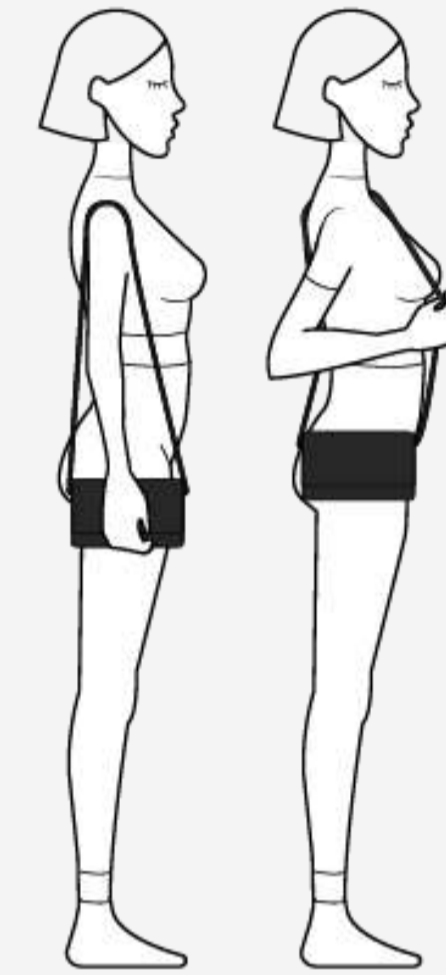

140 cm
(INCLUDED)

EXTRA SPACIOUS

AMPARITO (THE ELDER ONE)

SHOP

RETAIL PRICE: 164,95€

*Sign in to your account to see your wholesale price

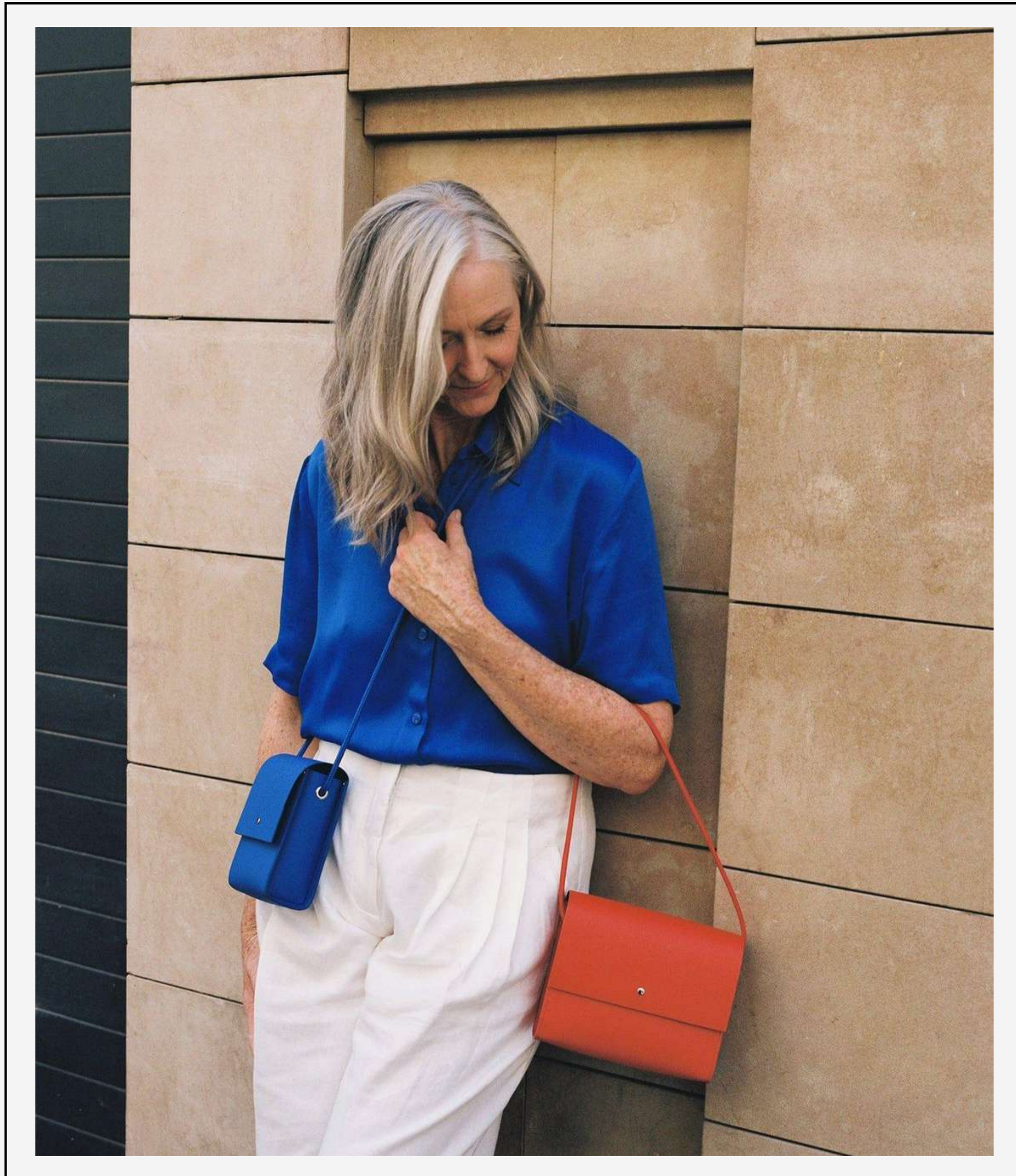

BASICS

CARMEN

A super light bag with plenty of space. It is the largest of the family of 3 (Carmelita, Carmela and Carmen).
Basic, not so basic.

DISCOVER

BASICS

CARMEN

- Magnet flap fastener
- One inside pocket
- Finished and painted edges for a greater protection
- One cord-strap included (140 cm)
- Extra cord-straps available: 50 cm, 100 cm, 120 cm or 140 cm
- Matching accessories

SHOP

EXTRAS

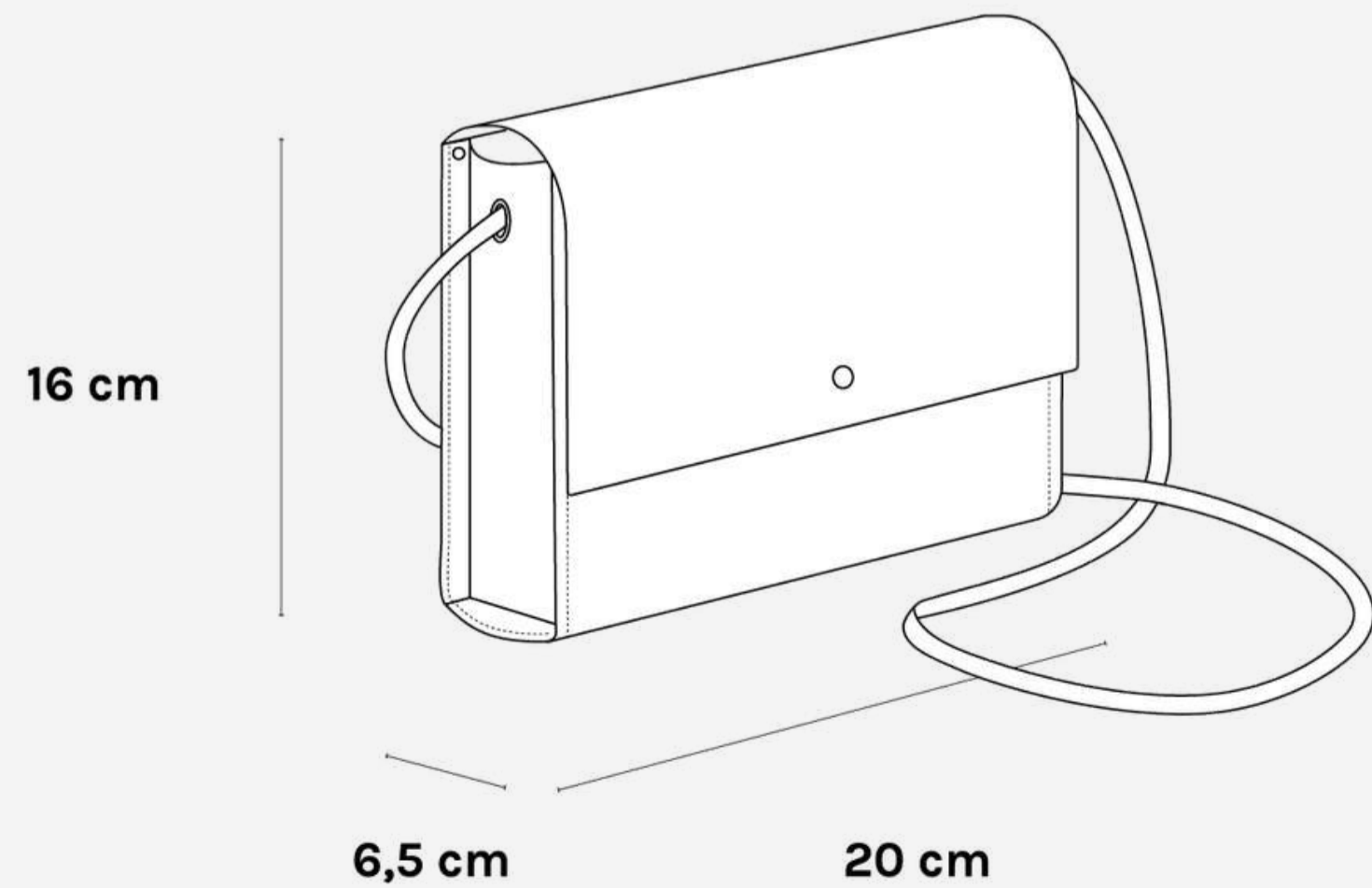

BRICK



RED



BOOM BLACK



NUDE



LIGHT-BLUE



WINE



CREAM



TANNED



NAVY



CLOVER GREEN



BIENHECHA BLUE



MAT BLACK



POSITIONS | * The model is 1.70 m tall



50 cm



100 cm



120 cm

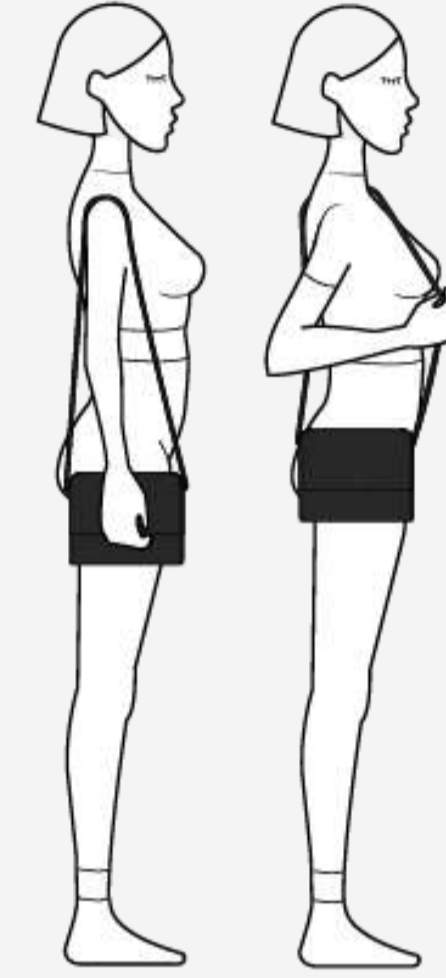

140 cm
(INCLUDED)

BASICS

CARMEN

SHOP

RETAIL PRICE: 159,95€

*Sign in to your account to see your wholesale price



BASICS

CARMELA

It's the middle child of a family of three (Carmelita, Carmela and Carmen). Basic but special, light, with enough space for the essentials and suuuuuper versatile.

DISCOVER

BASICS

CARMELA

- Magnet flap fastener
- One inside pocket
- Finished and painted edges for a greater protection
- One cord-strap included (140 cm)
- Extra cord-straps available: 50 cm, 100 cm, 120 cm or 140 cm
- Matching accessories

SHOP

EXTRAS

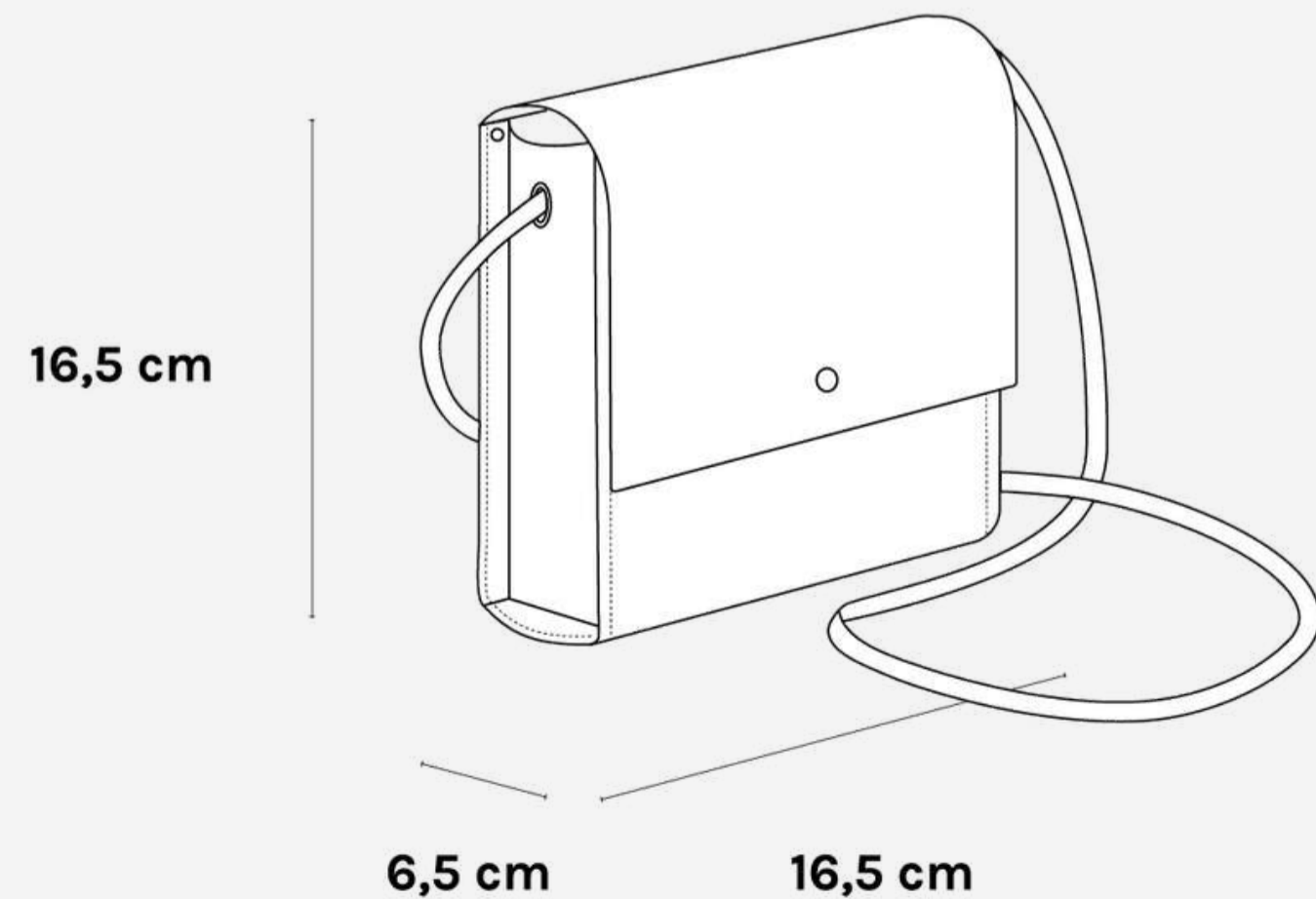

BRICK



RED



BOOM BLACK



NUDE



LIGHT-BLUE



WINE



CREAM



TANNED



NAVY



CLOVER GREEN



BIENHECHA BLUE



MAT BLACK



POSITIONS | * The model is 1.70 m tall



50 cm



100 cm



120 cm

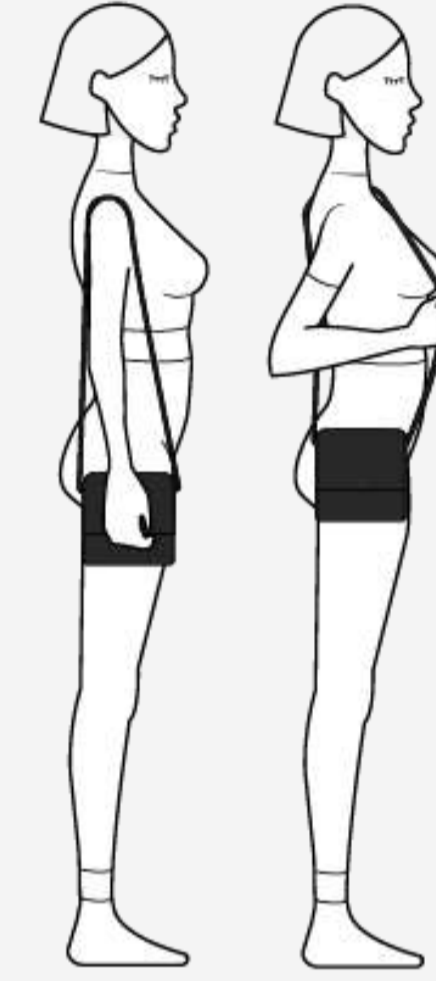

140 cm
(INCLUDED)

BASICS

CARMELA

SHOP

RETAIL PRICE: 154,95€

*Sign in to your account to see your wholesale price

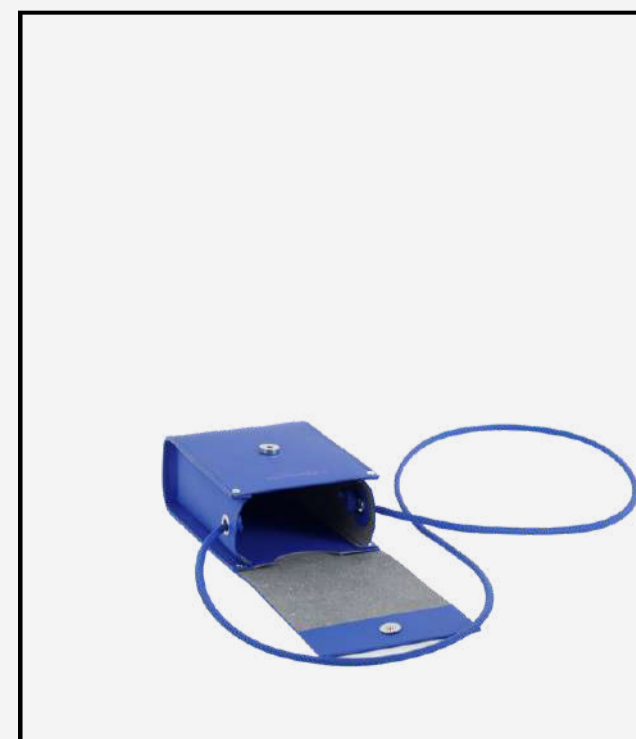
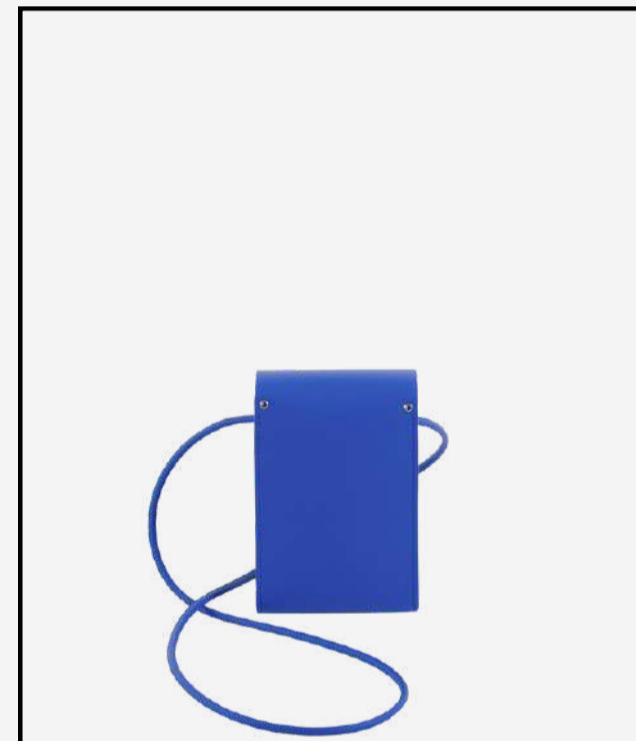
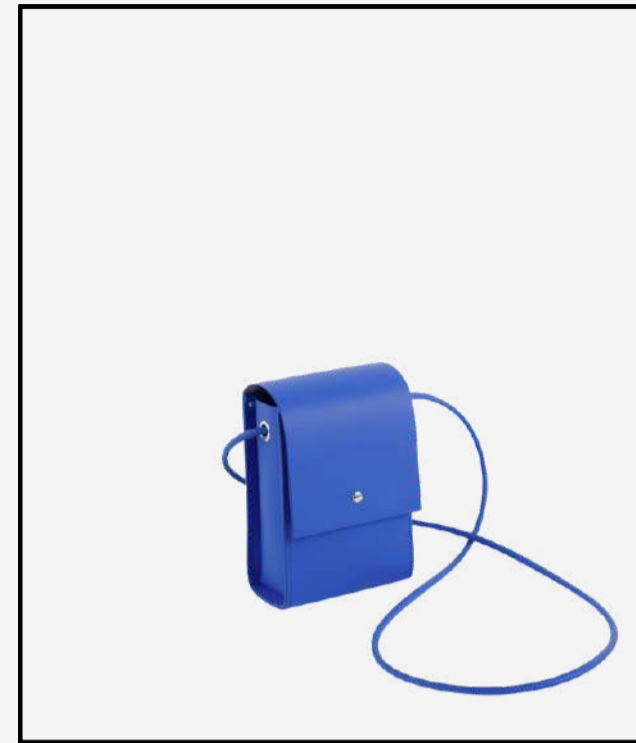

BASICS

CARMELITA

The smallest of the family of three (Carmelita, Carmela and Carmen) and full of personality. It weighs nothing at all and is really practical and simple.

DISCOVER

BASICS

CARMELITA

- Magnet flap fastener
- One inside pocket
- Finished and painted edges for a greater protection
- One cord-strap included (140 cm)
- Extra cord-straps available: 50 cm, 100 cm, 120 cm or 140 cm
- Matching accessories

SHOP

EXTRAS

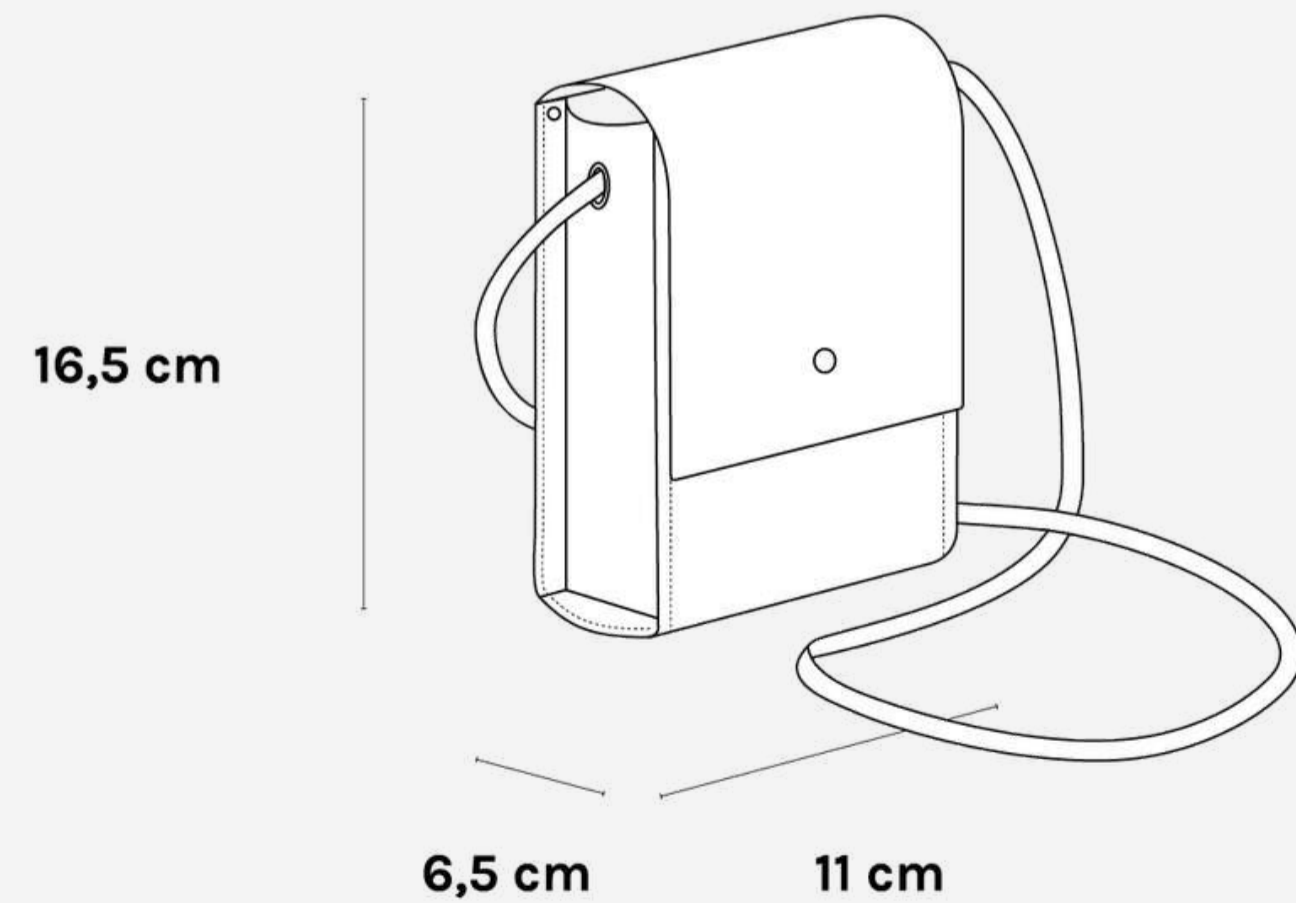

BRICK



RED



BOOM BLACK



NUDE

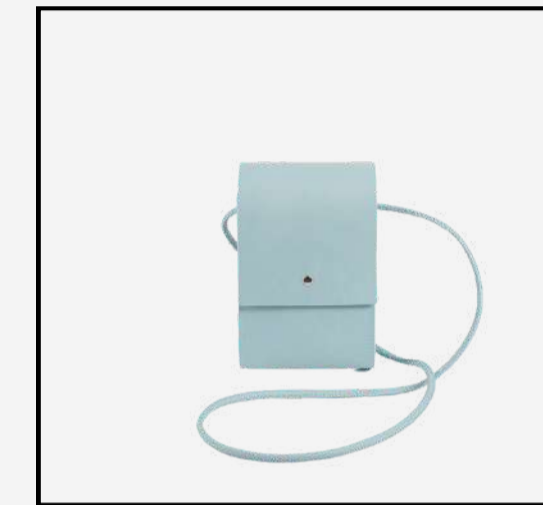

LIGHT-BLUE



WINE

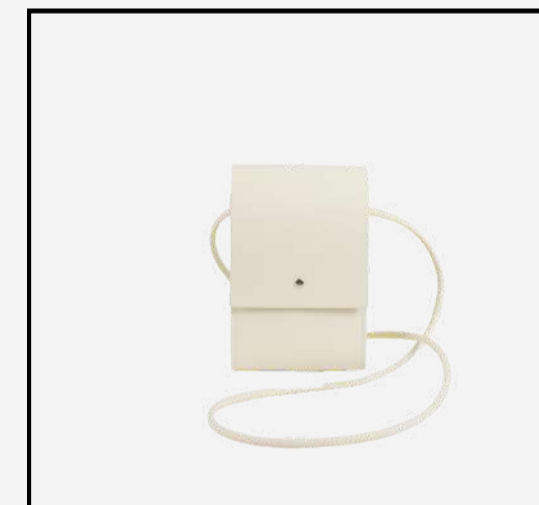

CREAM



TANNED

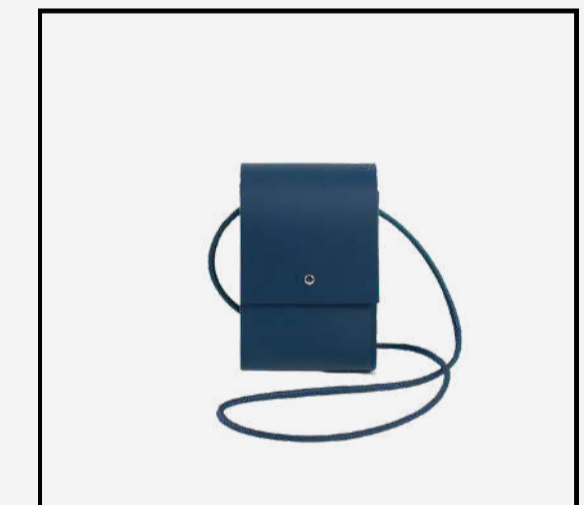

NAVY



CLOVER GREEN

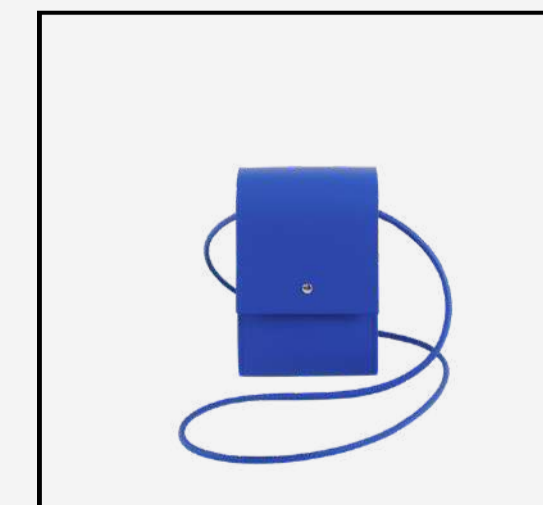

BIENHECHA BLUE

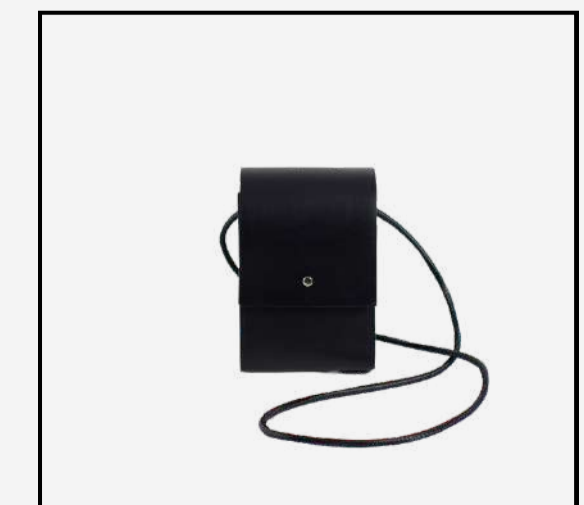

MAT BLACK



POSITIONS | * The model is 1.70 m tall



50 cm

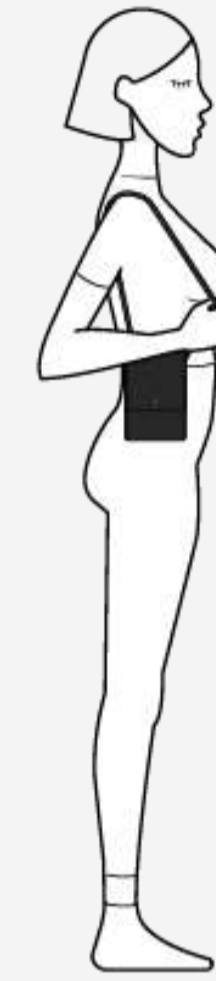

100 cm



120 cm

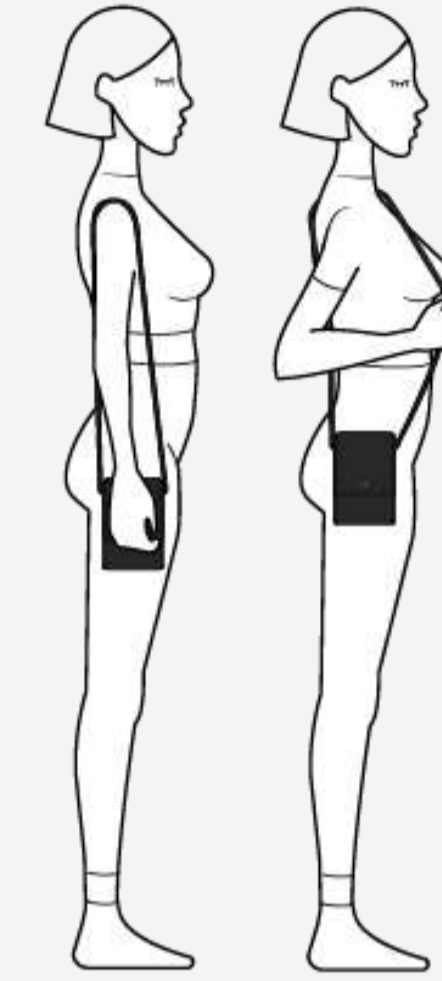

140 cm
(INCLUDED)

BASICS

CARMELITA

SHOP

RETAIL PRICE: 149,95€

*Sign in to your account to see your wholesale price



RECYCLED LEATHER

ACCESSORIES

Our accessories are the perfect choice to combine with our bags or to use on their own.

DISCOVER

ACCESSORIES

ROSARITO

- Zip fastener
- Finished and painted edges for a greater protection
- Perfect as a purse or to store cards, tickets, or anything else you want to keep separate inside the bag
- Perfect pack when combined with Rosario

SHOP

RETAIL PRICE: 49,95€

*Sign in to your account to see your wholesale price

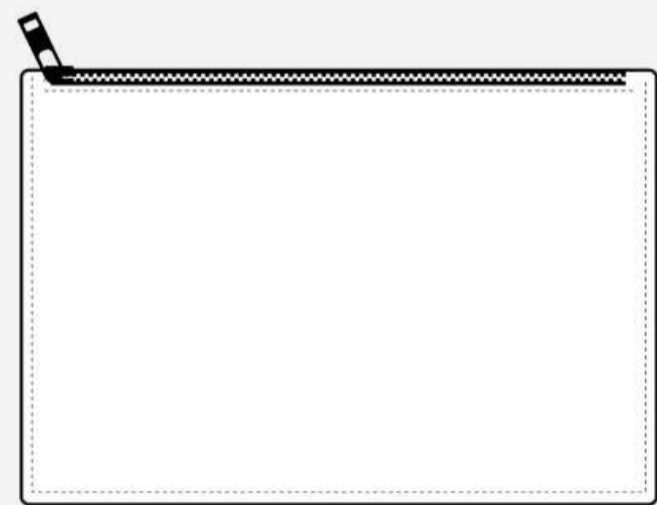

15 cm

10,5 cm



BRICK



RED



BOOM BLACK



NUDE



LIGHT-BLUE



WINE



CREAM



TANNED



NAVY



CLOVER GREEN



BIENHECHA BLUE



MAT BLACK

ACCESSORIES

ROSARIO

- Zip fastener
- Finished and painted edges for a greater protection
- Perfect as a purse or to store cards, tickets, or anything else you want to keep separate inside the bag
- Perfect pack when combined with Rosarito

SHOP

RETAIL PRICE: 54,95€

*Sign in to your account to see your wholesale price

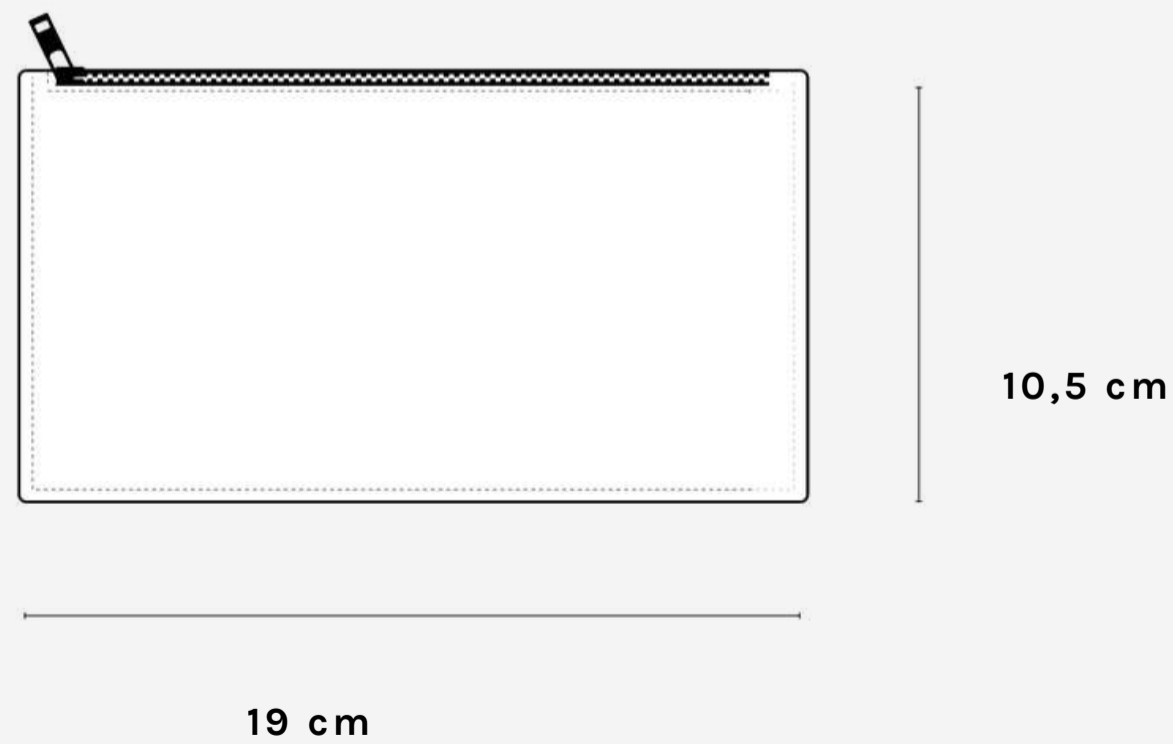

BRICK



RED



BOOM BLACK



NUDE



LIGHT-BLUE



WINE



CREAM



TANNED



NAVY



CLOVER GREEN



BIENHECHA BLUE



MAT BLACK

ACCESSORIES

OLIVIA

- Double card holder (maximum 6 cards)
- Finished and painted edges for a greater protection
- Perfect for storing cards, tickets, transport vouchers, etc.

SHOP

RETAIL PRICE: 39,95€

*Sign in to your account to see your wholesale price

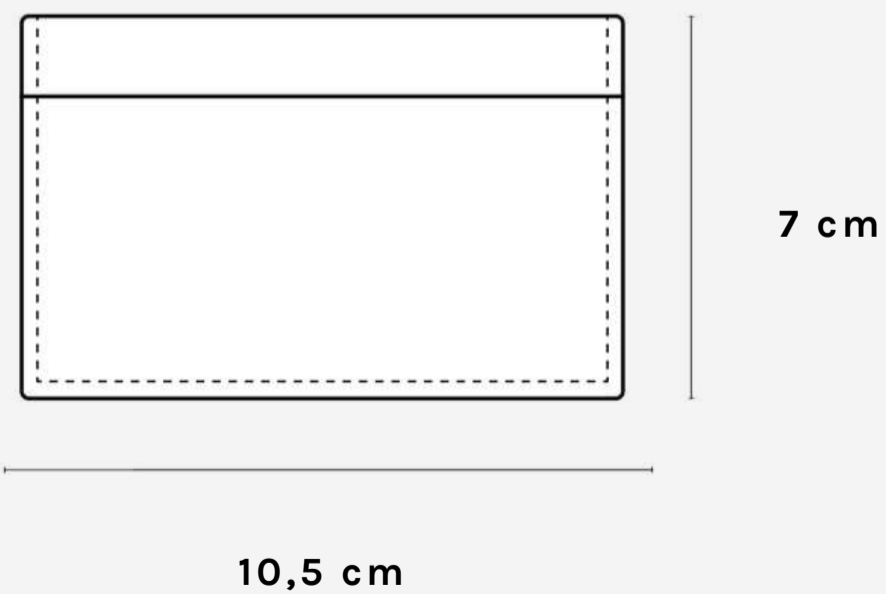

BRICK

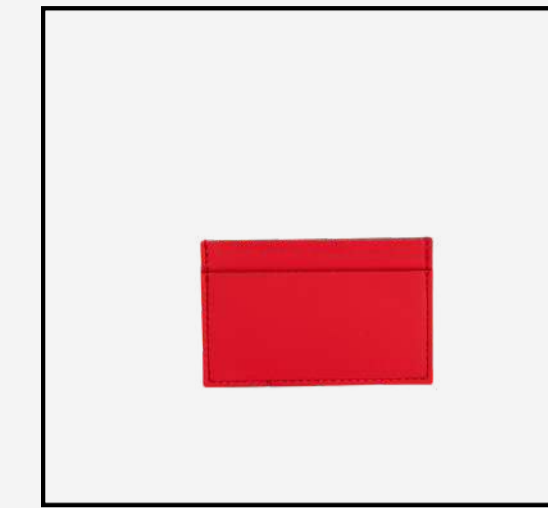

RED

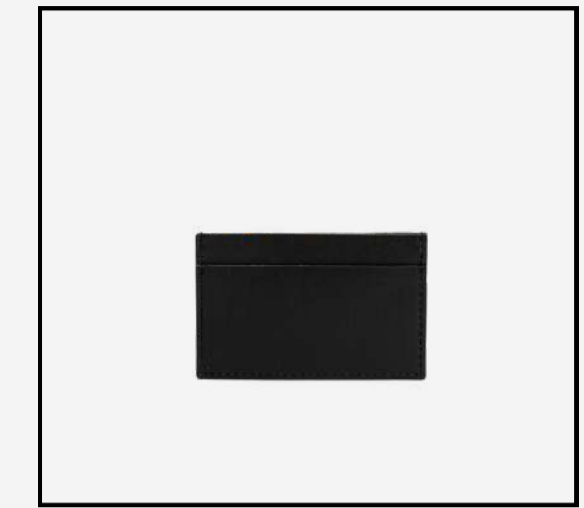

BOOM BLACK



NUDE

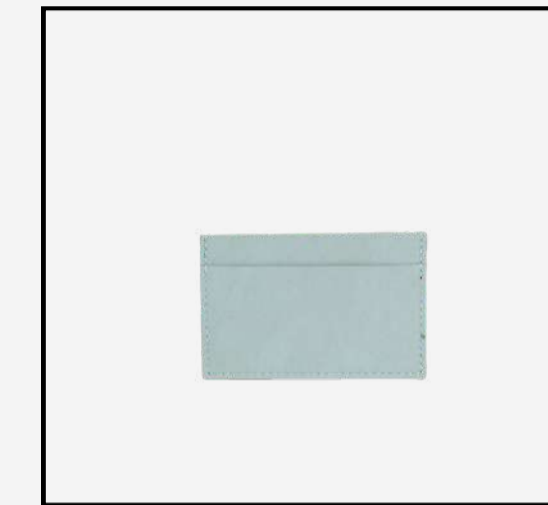

LIGHT-BLUE

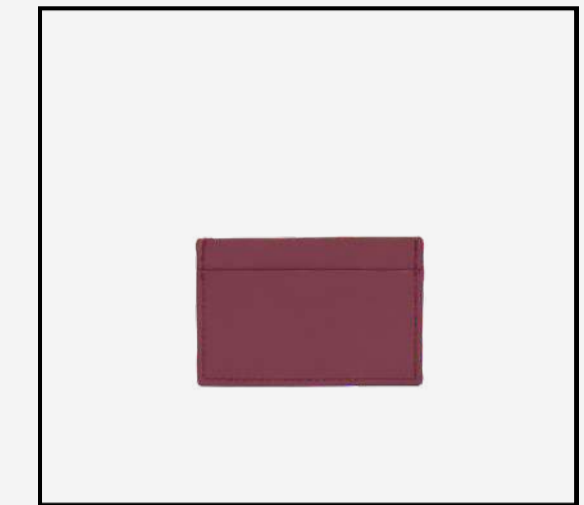

WINE

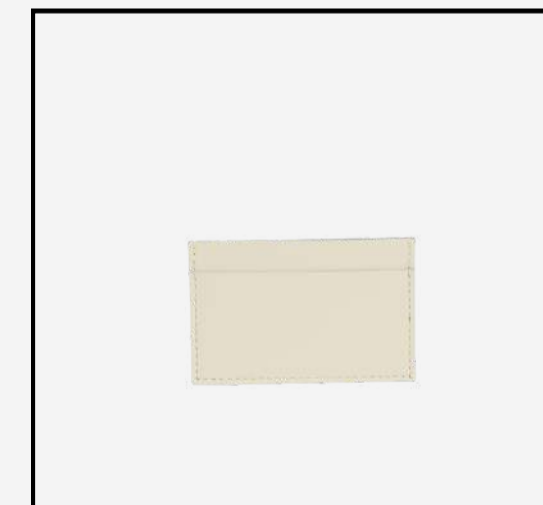

CREAM



TANNED



NAVY

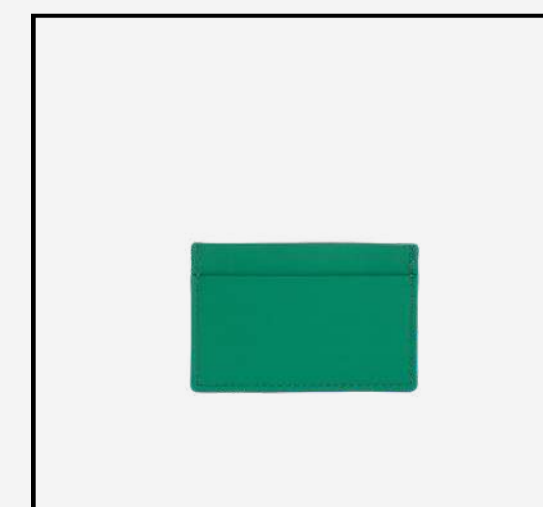

CLOVER GREEN

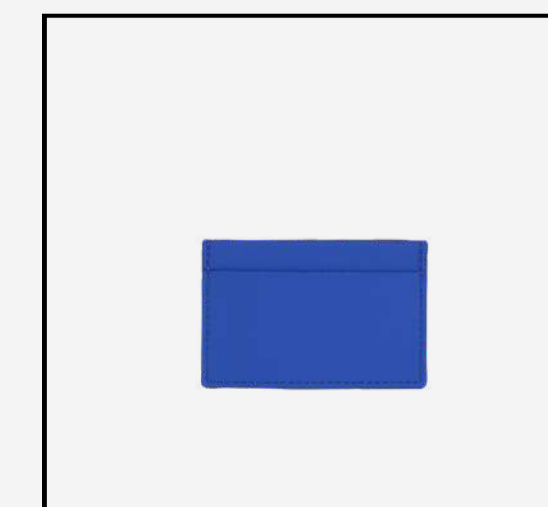

BIENHECHA BLUE



MAT BLACK



RECYCLED LEATHER

EXTRAS

To spice up our bienhechas. Add straps and cords to interchange, mix colours, and make several bags in one.

DISCOVER

EXTRAS

SHOULDER BAG PAD

- Small: 2,5 cm x 12,5 cm - For Paca and Paquita
- Big: 4 cm x 18 cm - Bernardita, Bernarda, Carmen, Carmela, Carmelita, Amparito (The Elder One) and Encarnita (The Elder One)

SHOP

RETAIL PRICE: 24,95€

*Sign in to your account to see your wholesale price

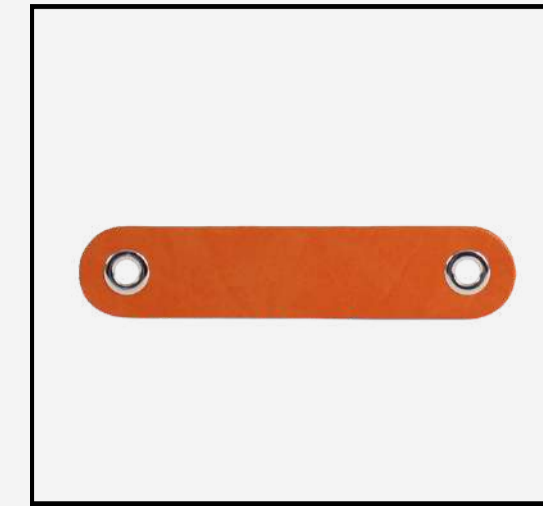

BRICK

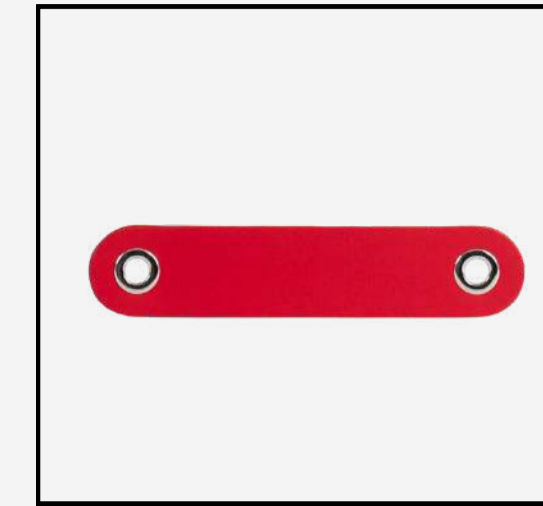

RED

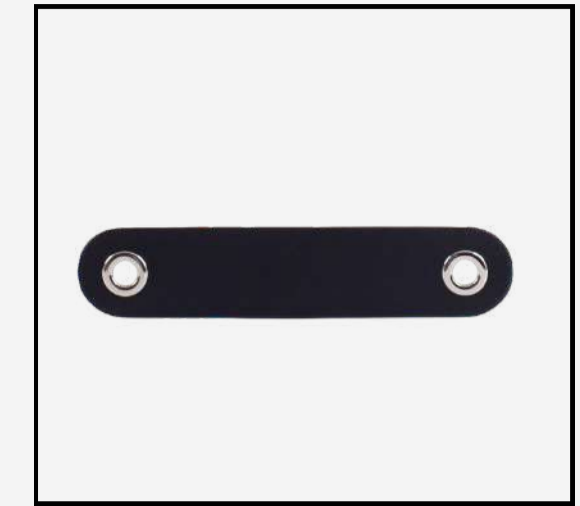

BOOM BLACK

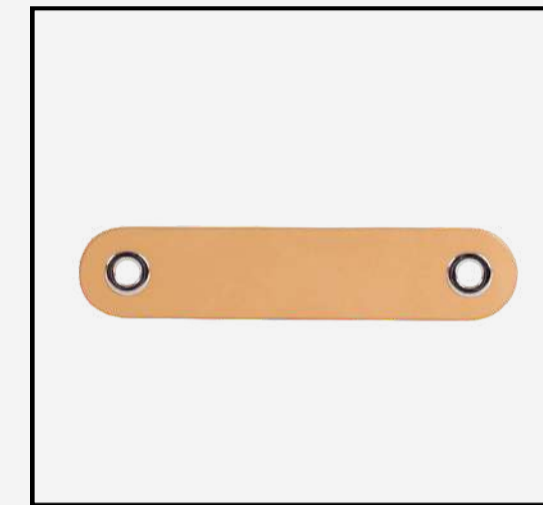

NUDE

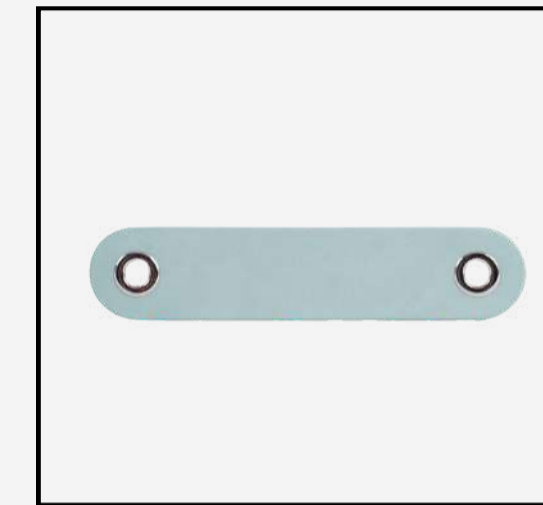

LIGHT-BLUE

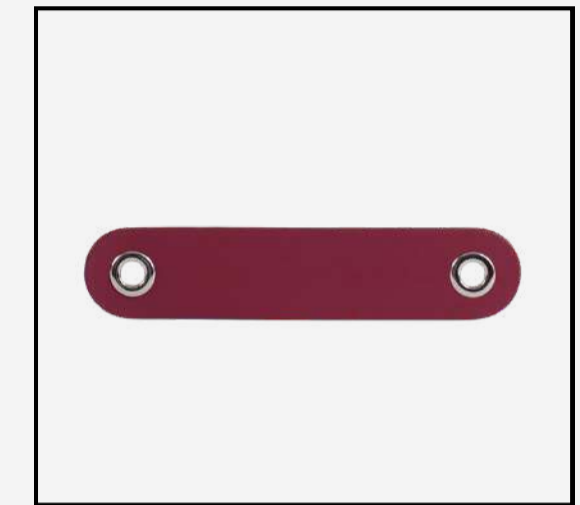

WINE



CREAM



TANNED



NAVY

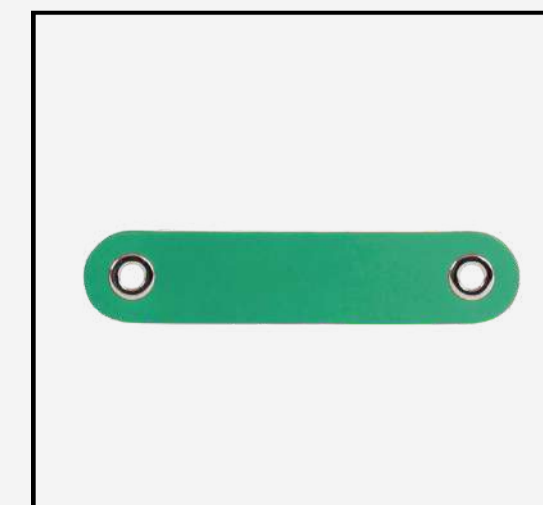

CLOVER GREEN

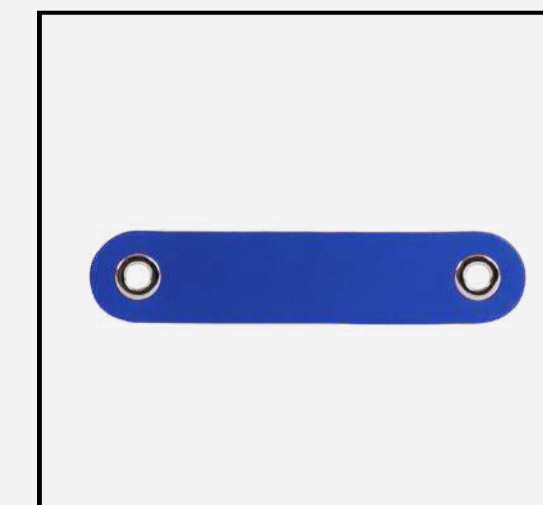

BIENHECHA BLUE



MAT BLACK

EXTRAS

CORDS

- Adjustable sizes available: 50 cm, 100 cm, 120 cm and 140 cm
- Mini: 0,4 diámetro - For Paca and Paquita
- Maxi: 0,6 diámetro - For Bernardita, Bernarda, Carmen, Carmela, Carmelita, Amparito (The Elder One) and Encarnita (The Elder One)

SHOP

RETAIL PRICE: 15,95€

*Sign in to your account to see your wholesale price



BRICK



RED



BOOM BLACK



NUDE

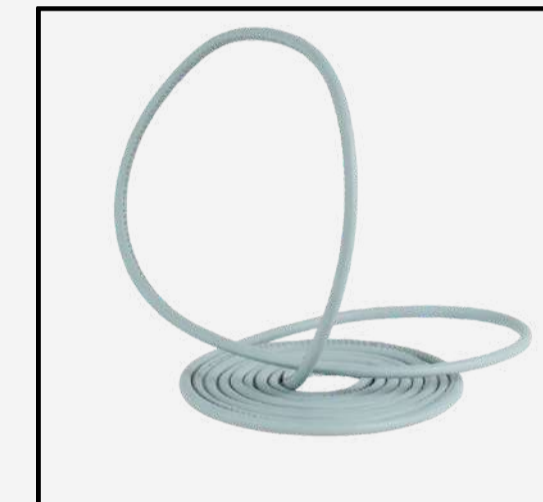

LIGHT-BLUE



WINE



CREAM



TANNED



NAVY



CLOVER GREEN



BIENHECHA BLUE



MAT BLACK

EXTRAS

BELTS

- Available sizes: 120 cm and 140 cm
- Finished and painted edges
- Adjustable
- Compatible with LOLA (THE ELDER ONE)

SHOP

RETAIL PRICE: 59,95€

*Sign in to your account to see your wholesale price



BRICK



RED



BOOM BLACK



NUUDE



LIGHT-BLUE



WINE



CREAM



TANNED



NAVY



CLOVER GREEN



BIENHECHA BLUE



MAT BLACK

EXTRAS

STRAPS

- Available sizes: 60 cm, 70 cm, 80 cm, 100 cm, 120 cm y 140 cm
- Finished and painted edges
- Adjustable
- Compatible with Sofía Madre, Sofía Hija, Josefa, Pepa

SHOP

RETAIL PRICE: 34,95€

*Sign in to your account to see your wholesale price

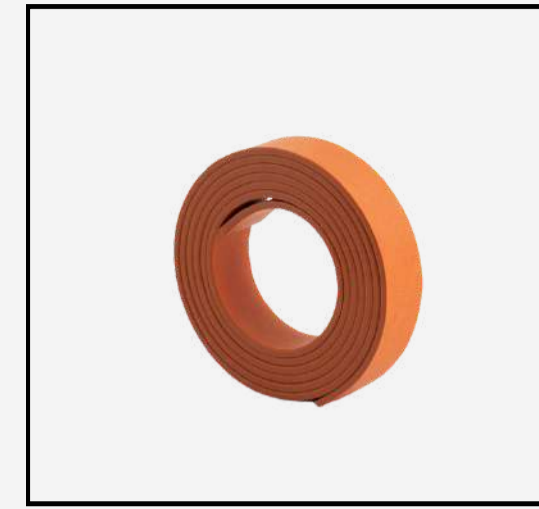

BRICK



RED



BOOM BLACK

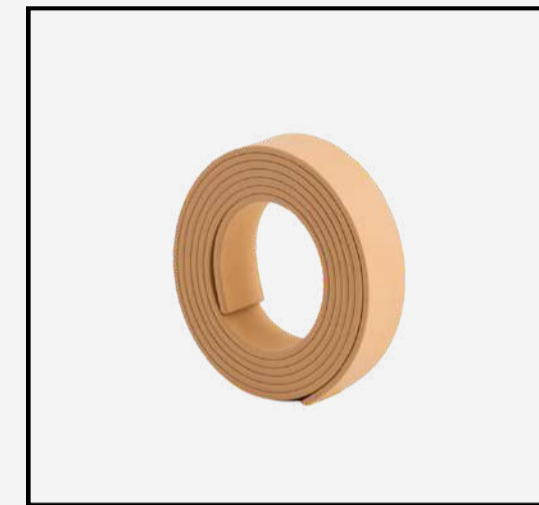

NUPE

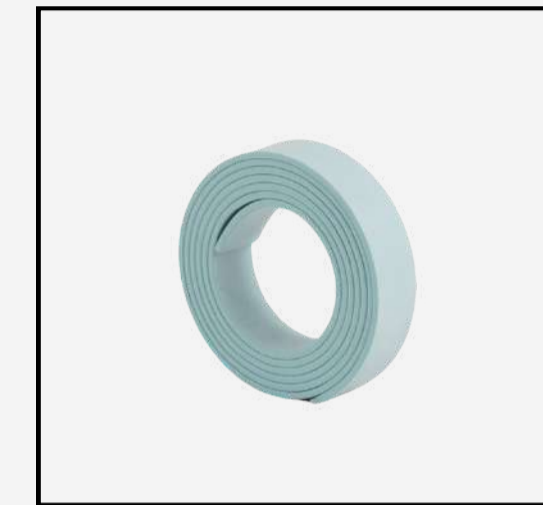

LIGHT-BLUE



WINE



CREAM



TANNED



NAVY



CLOVER GREEN

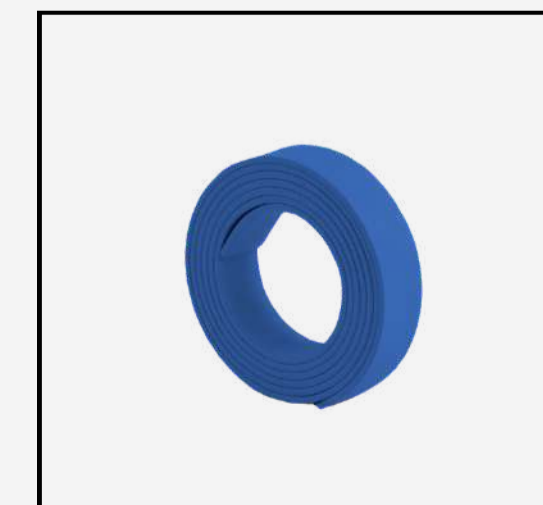

BIENHECHA BLUE



MAT BLACK

EXTRAS

CARABINER STRAP

- Available sizes: 60 cm, 70 cm, 100 cm, 120 cm and 140 cm
- Finished and painted edges
- Adjustable
- Compatible with Sofía Madre, Sofía Hija, Josefa, Pepa

SHOP

RETAIL PRICE: 39,95€

*Sign in to your account to see your wholesale price



BRICK



RED



BOOM BLACK

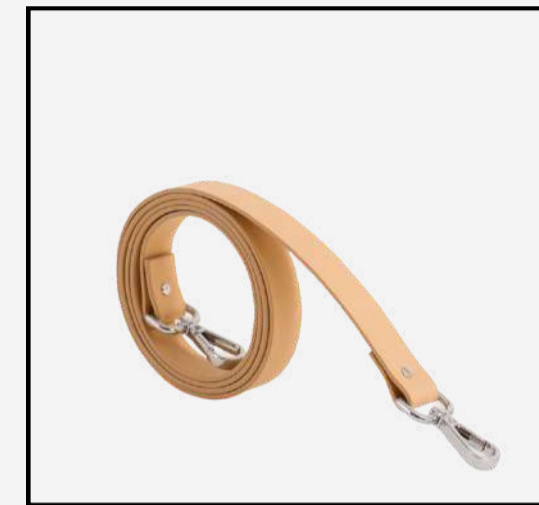

NUPE



LIGHT-BLUE



WINE



CREAM

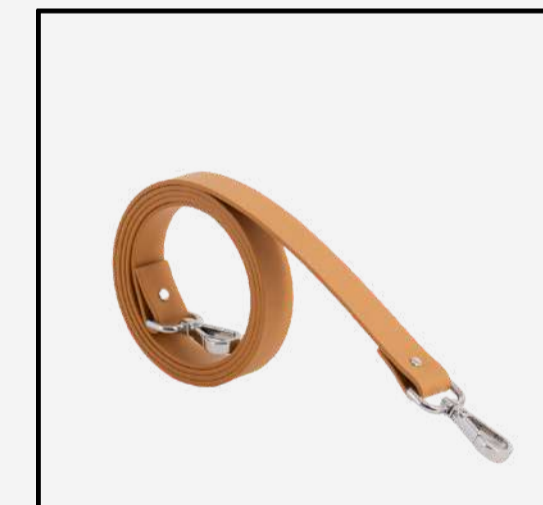

TANNED



NAVY



CLOVER GREEN



BIENHECHA BLUE

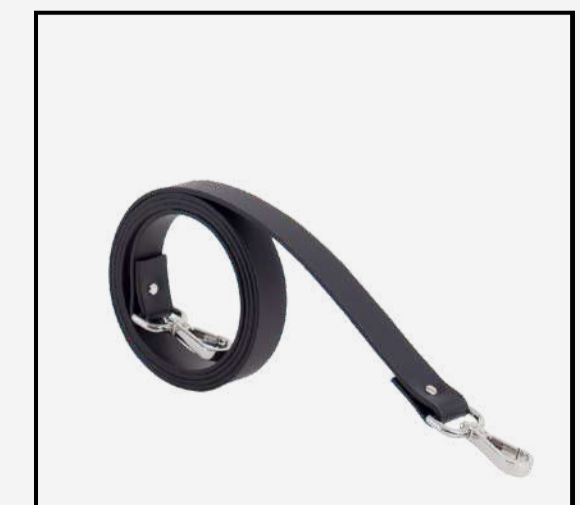

MAT BLACK



RECYCLED LEATHER

EARRINGS

Our earrings are made using all the recycled leather scraps and putting kilos and kilos of love into each piece.

[DISCOVER](#)

EARRINGS

CLARA

- Very light
- Antiallergic (the trimming is made of surgical steel)
- Handcrafted with small scraps of leather to reduce our waste and make the most of everything we have in the workshop
- Hand-painted and polished edges, one by one
- Sizes: 1'5 cm (in its wider part) x 2'5 cm (more or less, as they're handmade :))
- Order them in your colour palette

SHOP

RETAIL PRICE: 39,95€

*Sign in to your account to see your wholesale price

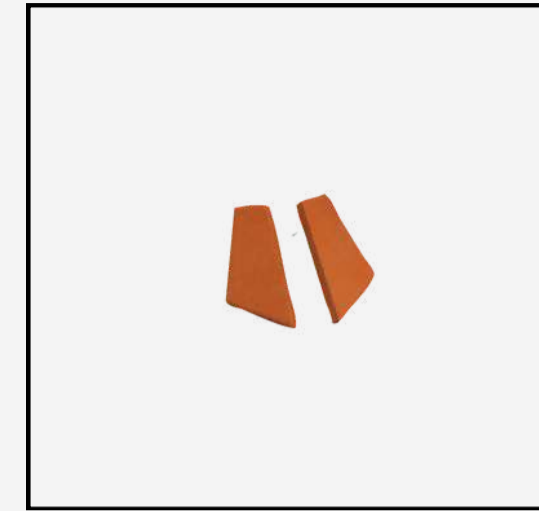

BRICK

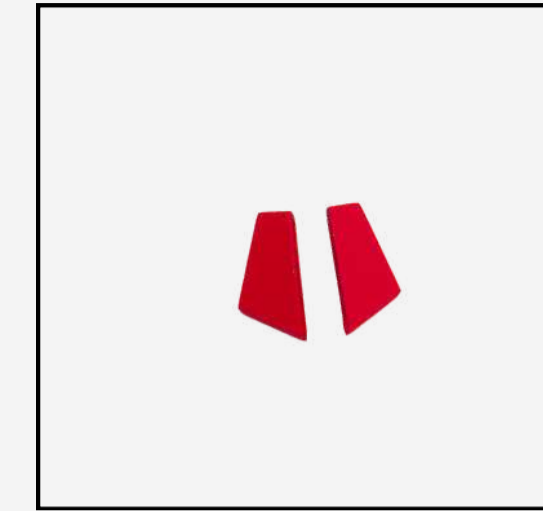

RED



BOOM BLACK

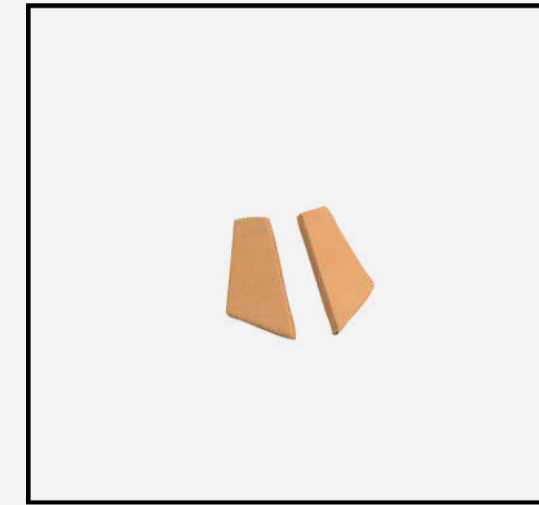

NUDE

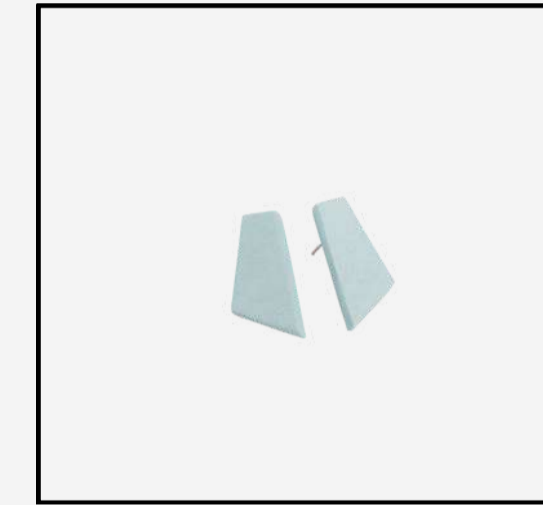

LIGHT-BLUE

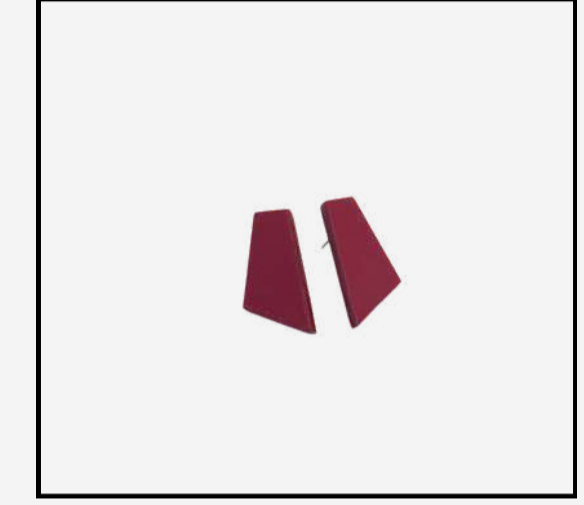

WINE

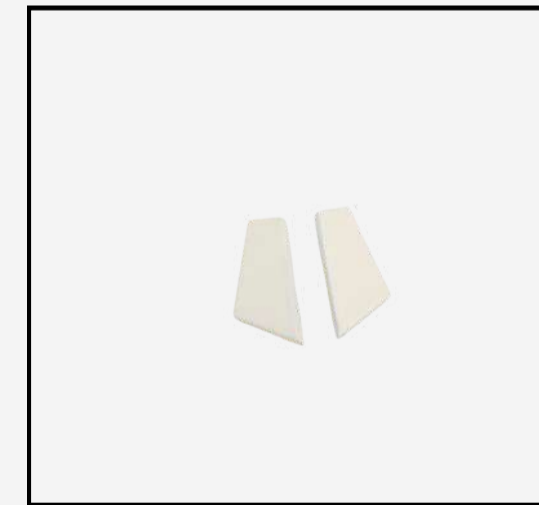

CREAM

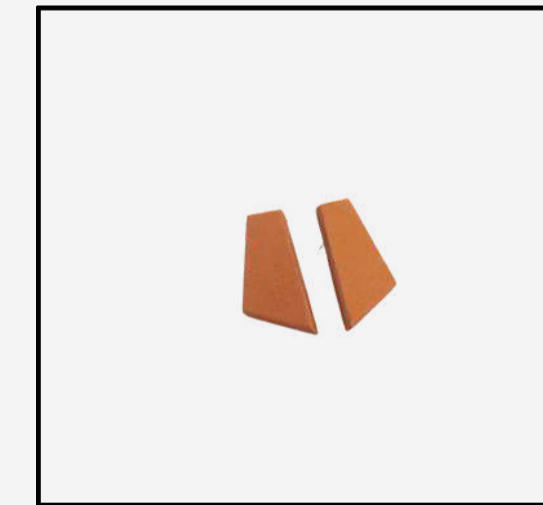

TANNED



NAVY

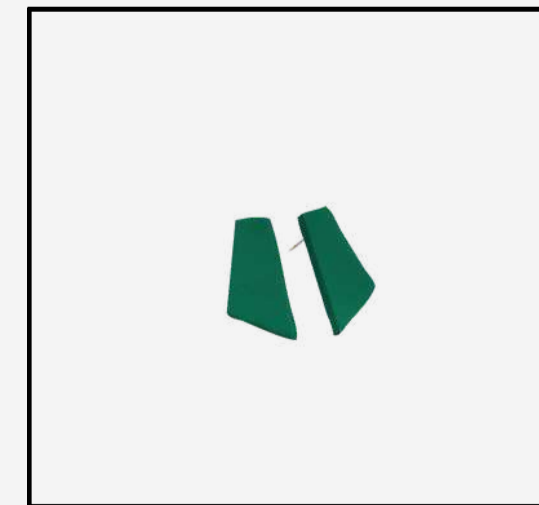

CLOVER GREEN

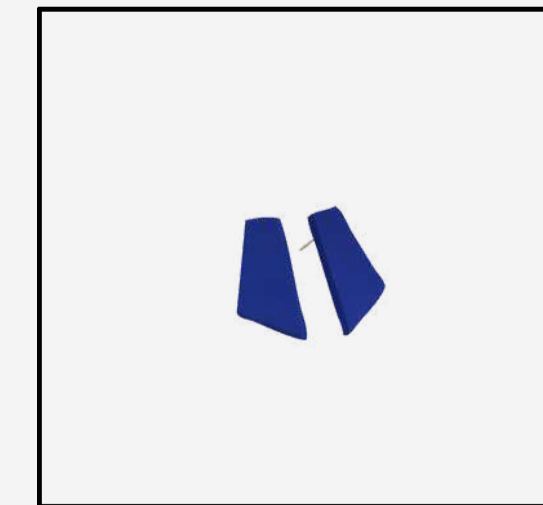

BIENHECHA BLUE

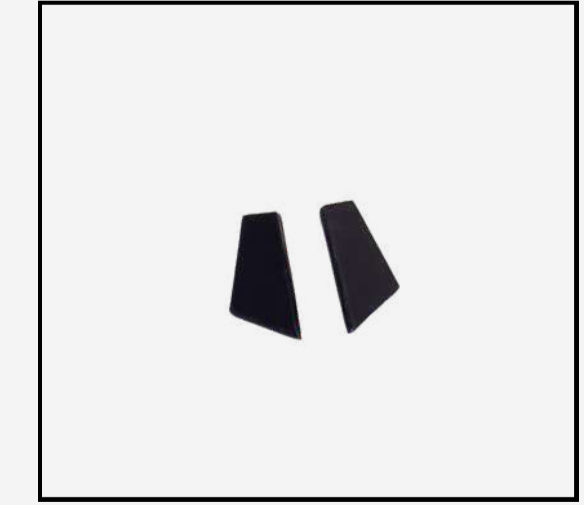

MAT BLACK

EARRINGS

IRENE

- Very light
- Antiallergic (the trimming is made of surgical steel)
- Handcrafted with small scraps of leather to reduce our waste and make the most of everything we have in the workshop
- Hand-painted and polished edges, one by one
- Sizes: 2 cm (in its wider part) x 5 cm (more or less, as they're handmade :))
- Order them in your colour palette

SHOP

RETAIL PRICE: 44,95€

*Sign in to your account to see your wholesale price

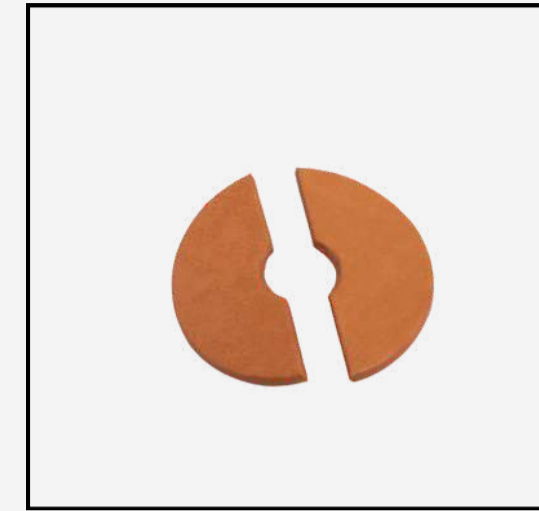

BRICK

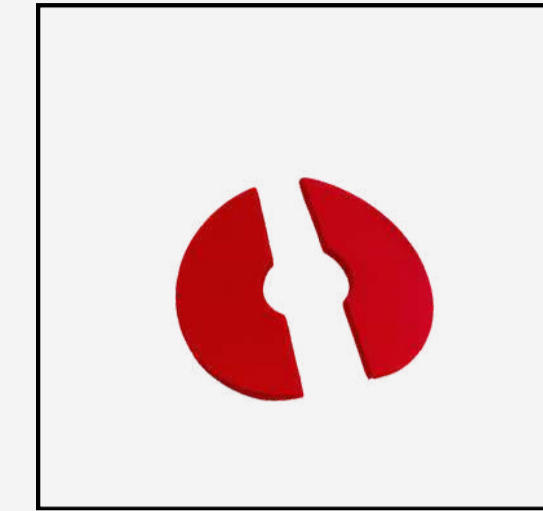

RED



BOOM BLACK

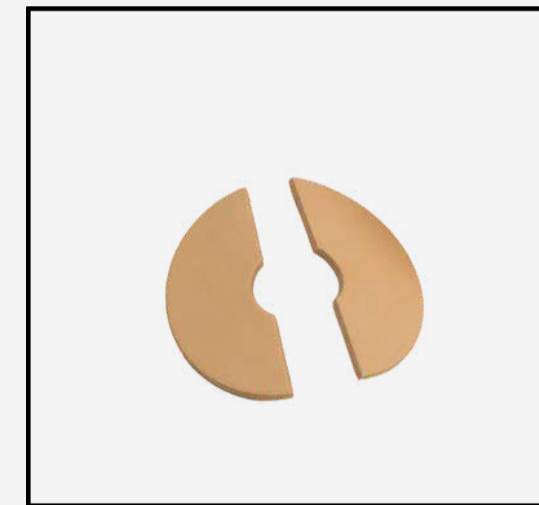

NUDE

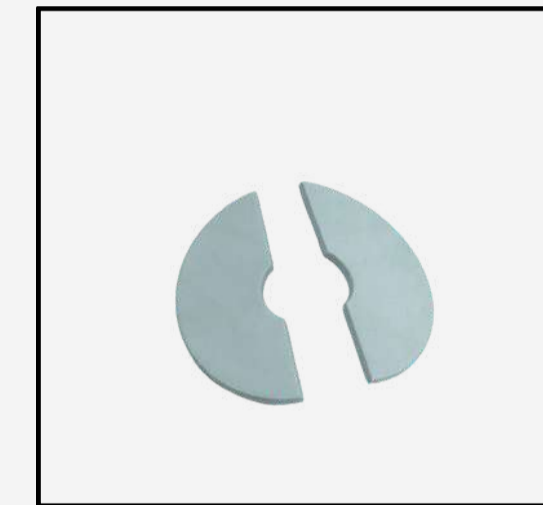

LIGHT-BLUE

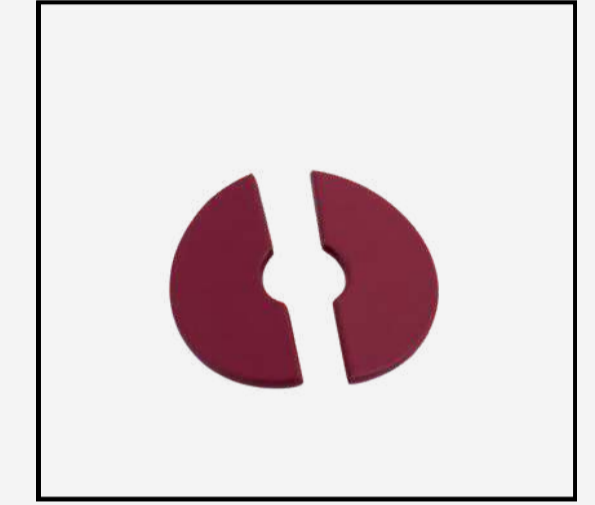

WINE

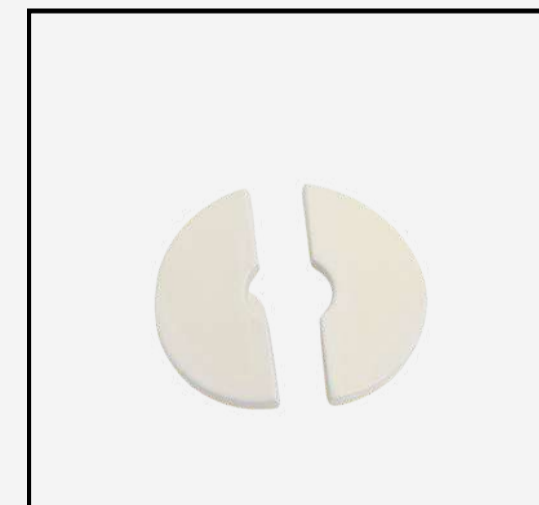

CREAM

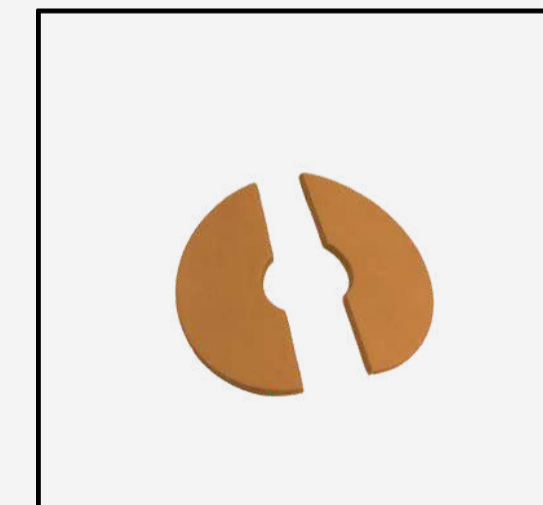

TANNED

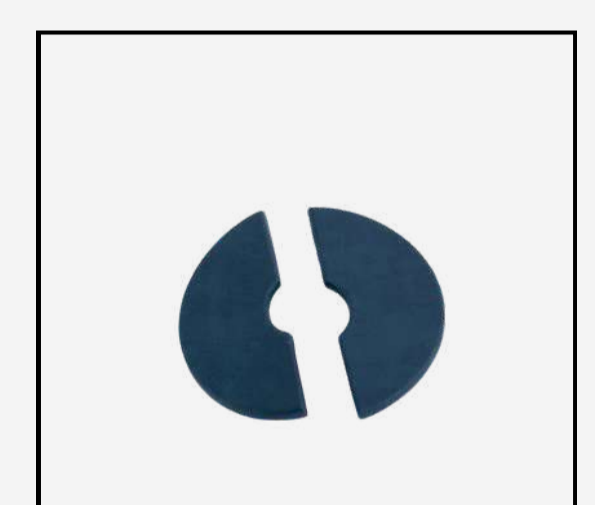

NAVY

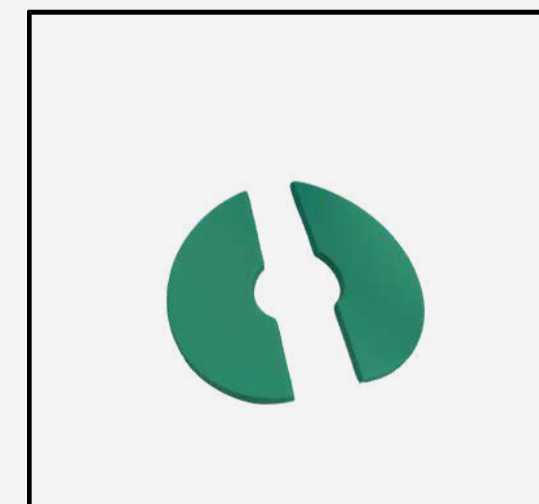

CLOVER GREEN

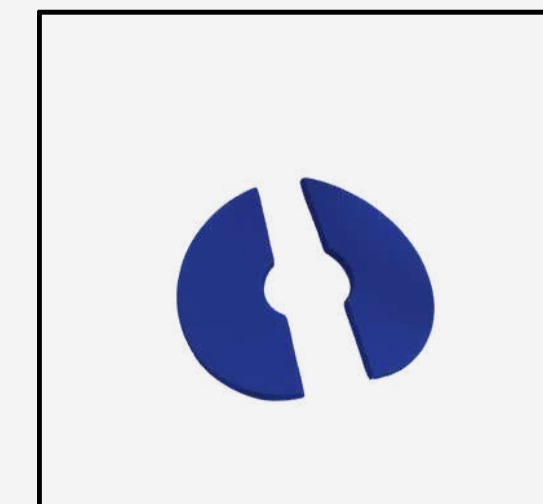

BIENHECHA BLUE

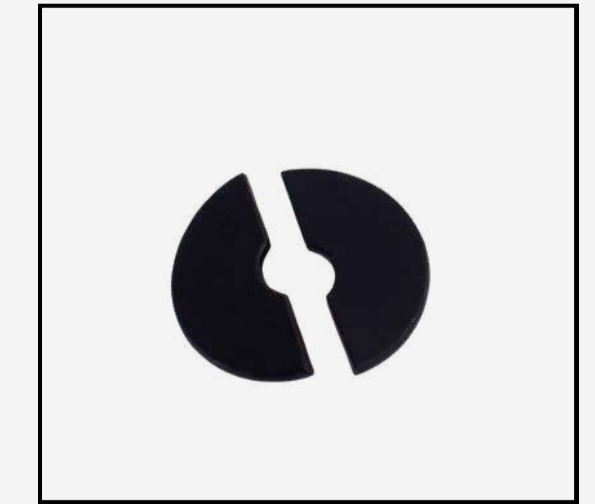

MAT BLACK

EARRINGS

ANA

- Very light
- Antiallergic (the trimming is made of surgical steel)
- Handcrafted with small remains of leather to reduce our waste and make the most of everything we have in the workshop
- Hand-painted and polished edges, one by one
- Sizes: 2'5 cm (in its wider part) x 3 cm (more or less, as they're handmade :))
- Order them in your colour palette

SHOP

RETAIL PRICE: 44,95€

*Sign in to your account to see your wholesale price

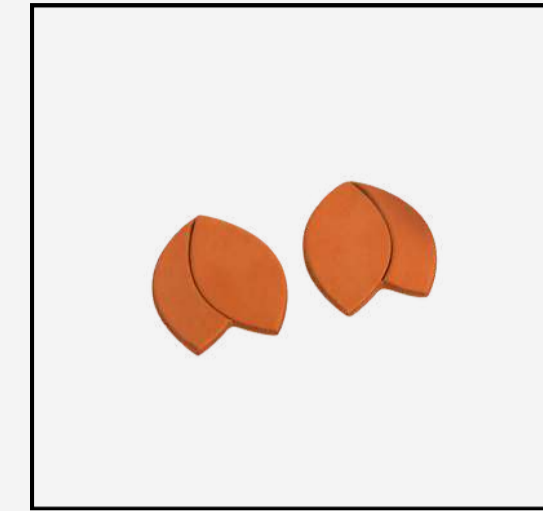

BRICK

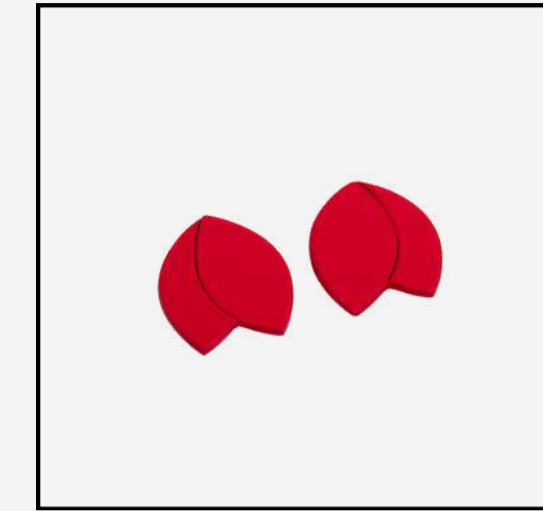

RED



BOOM BLACK

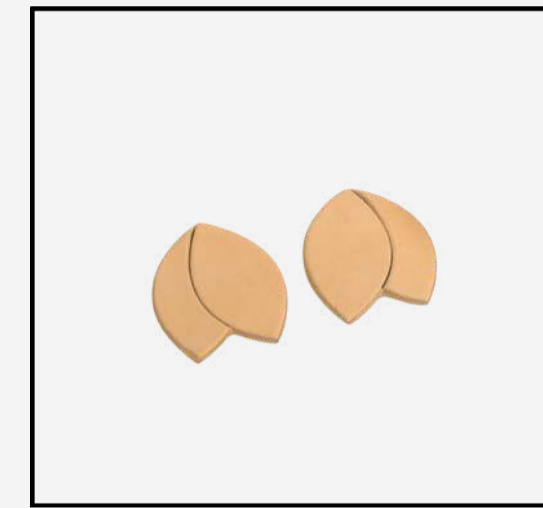

NUDE

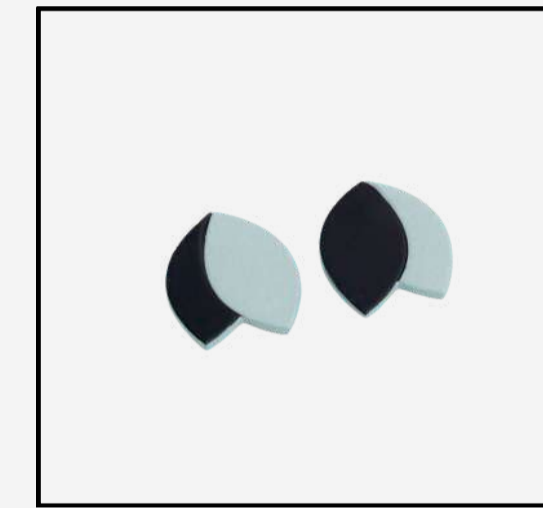

LIGHT-BLUE

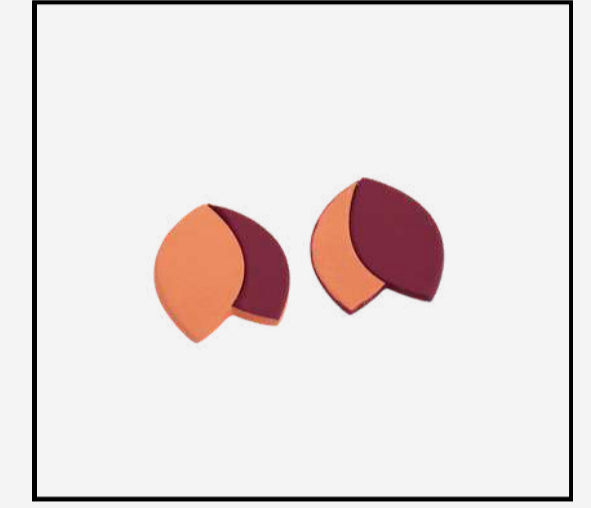

WINE

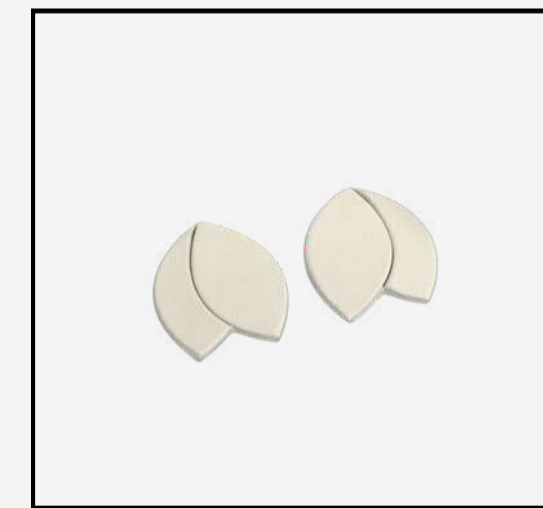

CREAM



TANNED



NAVY

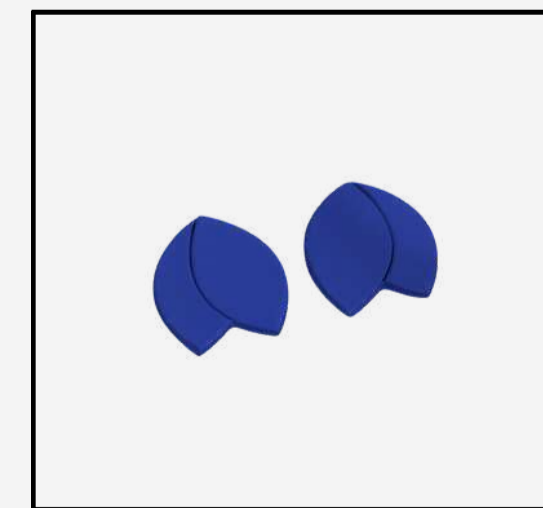

CLOVER GREEN

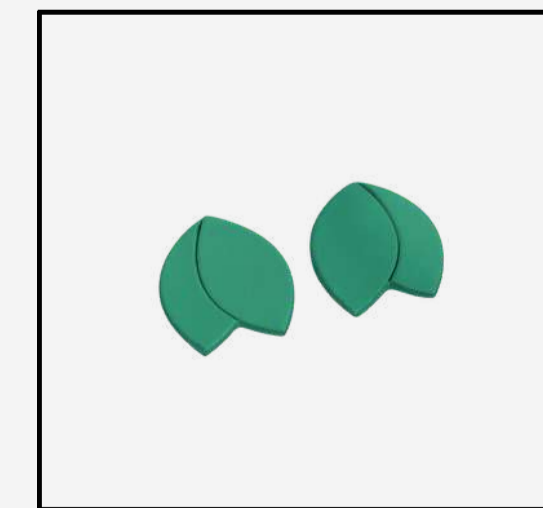

BIENHECHA BLUE

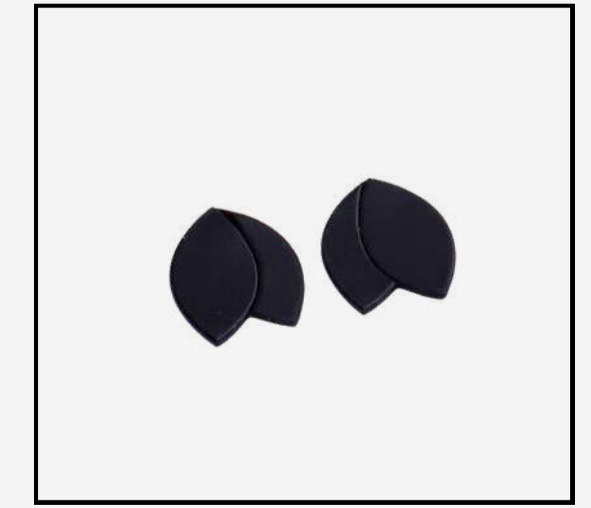

MAT BLACK

EARRINGS

CRISTINA

- Very light
- Antiallergic (the trimming is made of surgical steel)
- Handcrafted with small remains of leather to reduce our waste and make the most of everything we have in the workshop
- Hand-painted and polished edges, one by one
- Sizes: 1'5 cm (in its wider part) x 2'5 cm (more or less, as they're handmade :))
- Order them in your colour palette

SHOP

RETAIL PRICE: 54,95€

*Sign in to your account to see your wholesale price



BRICK

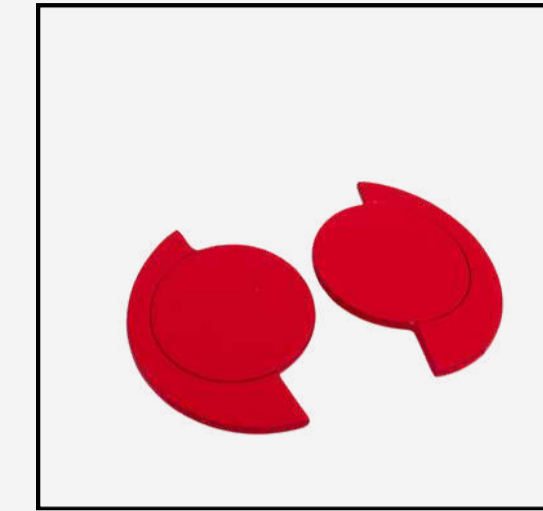

RED



BOOM BLACK

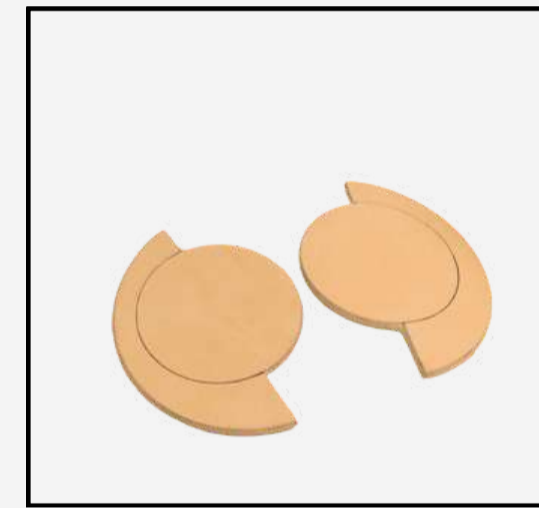

NUDE



LIGHT-BLUE

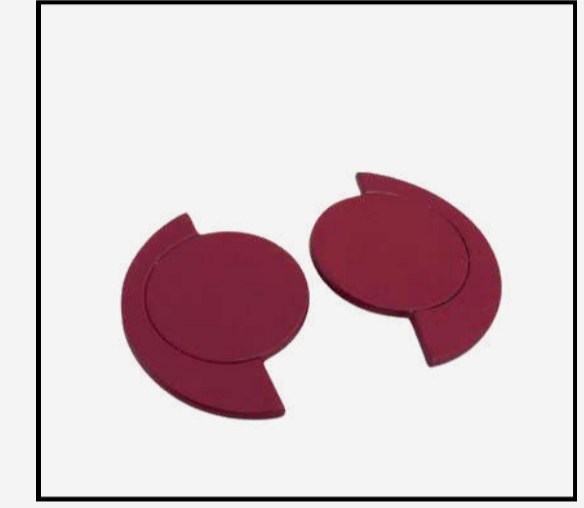

WINE

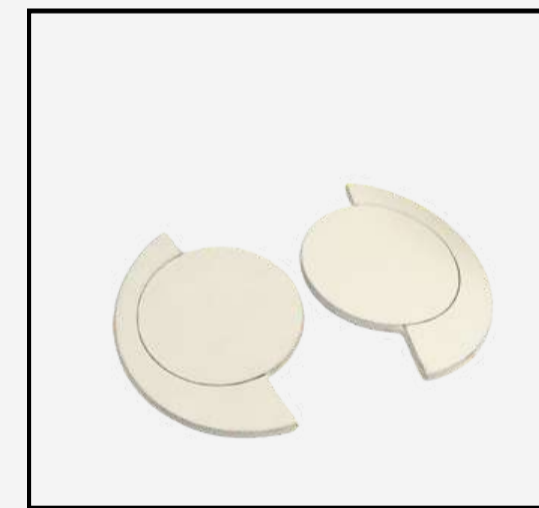

CREAM



TANNED



NAVY

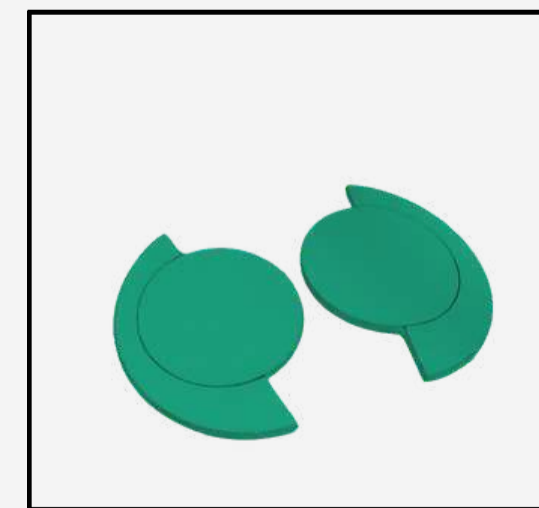

CLOVER GREEN

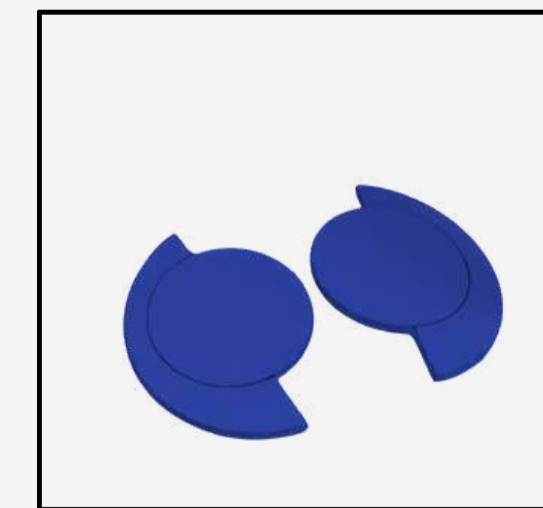

BIENHECHA BLUE

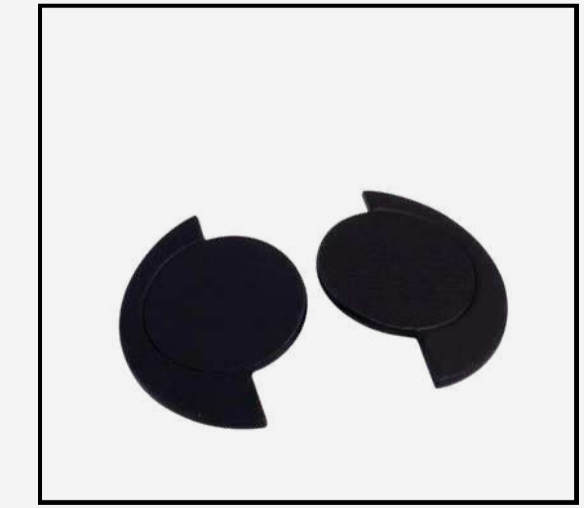

MAT BLACK

TOP 10

BEST-SELLERS

The bienhechas that have been conquering hearts for a long time.

Some of them have been with us since minute one... and we keep on producing them non-stop.

SHOP



PAQUITA DISCOVER →



RAMONA DISCOVER →



PEPA DISCOVER →



SOFÍA (HIJA) DISCOVER →



ANGELINES DISCOVER →



SOFÍA (MADRE) DISCOVER →



ENCARNITA (LM) DISCOVER →



BERNARDITA DISCOVER →



BERNARDA DISCOVER →



JOSEFA DISCOVER →



WHO ARE WE?

ABOUT LABIENHECHA

We are a team of women making (well-made) things in a workshop in Malaga and working along three lines of action: creating a quality, local and ecological product; raising awareness about sustainability and, on the other hand, empowering the female role in entrepreneurship and in life in general.

What makes us most proud of our project?

- 100% handmade, local and ecological product.
- Made in Spain, in our workshop, in a responsible and ethical way.
- Top quality sustainable materials, always certified
- We empower female entrepreneurship



HOW DO WE DO IT?

OUR WORKSHOP DISCOVER

Everything we make is produced in our own workshop, with our own hands - in an artisan and honest way - trying to damage our environment as little as possible, striving to keep tradition alive and, of course, with tons and tons of love.

At Labienhecha we take care of everything. When we say everything, we mean EVERYTHING. From the idea to the design, the making of the bag, the marketing, the commercialisation, administration... Everything!

HOW DO WE DO IT?

SUSTAINABLE PRODUCTION

We believe that nothing is 100% sustainable, but that with small acts and our decisions as a brand, we can reduce our negative impact and foster a culture around sustainability.

We consider all perspectives on sustainability (economic, environmental and/or social and labour). Therefore, we want to advance in our own R&D, working with other sustainable and certified materials, offering other alternatives, expanding our knowledge, improving our resources to achieve better results, optimising our workshop and always aiming to damage our planet as little as possible.



HOW DO WE DO IT?

OUR MATERIALS

At Labienhecha we strive to research materials that meet our high requirements in terms of sustainability. That is why we only work with eco-friendly, durable, quality materials that are environmentally friendly and have the least negative impact. These are the main materials we work with:



VEGAN BIOMATERIAL



RECYCLED LEATHER



ORGANIC COTTON

HELP

NEW CLIENT REGISTRATION →

CLIENT ACCESS →

B2B SHOPPING PORTAL →

QUICK ORDER →

REQUEST DEMO →

PROMOTIONS →

FAQS →

CLIENT AREA

ORDER FORM



WE DON'T MAKE PERFECT THINGS,
WE JUST MAKE WELL-MADE THINGS

Labienhecha

CONTACTO

C/ Croacia, 19. CP: 29004 - Málaga, España
sales@labienhecha.com

SOCIAL & WEB

FB: Labienhecha
IG: @soylabienhecha
WEB: labienhecha.com

INFO

We design and create bags and other beloved goods using only certified eco-materials. Everything is made on a slow burn in a small workshop in Málaga by a super team of women that love what they do.