

CORE COLLECTION

2024

CATALOGUE



**Labienhecha**

# INDEX

---

COLLECTIONS →

RECYCLED LEATHER →

VEGAN →

ACCESSORIES →

EXTRAS →

EARRINGS →

TOP 10 - BEST-SELLERS →

ABOUT LABIENHECHA →

OUR WORKSHOP →

CLIENT AREA B2B →

CLIENT ACCOUNT

ORDER FORM



RECYCLED LEATHER COLLECTION

DISCOVER



VEGAN COLLECTION (PLASTIC-FREE)

DISCOVER





OUR OGS

## RECYCLED LEATHER COLLECTION

The core of our collection. They are the ones that have been with us since the very beginning and they don't seem to be going away. Labienhecha icons (and the best sellers). We produce them with recycled leather from a local supplier certified with Global Recycled Standard and Oeko Tex Leather Standard.

DISCOVER



THEY NEVER MISS

## SUPER TOP

The all-time favourites (and best sellers). They have been in our collection for years and have become true Labienhecha icons.

SHOP



PAQUITA

DISCOVER →



PACA

DISCOVER →



SOFÍA (HIJA)

DISCOVER →



SOFÍA (MADRE)

DISCOVER →



PEPA

DISCOVER →



JOSEFA

DISCOVER →

THE HEARTROBBERS

## THE MOST WANTED

They stand out for their special shape and their personality. Unique jewels of our collection that will make anyone fall in love.

SHOP

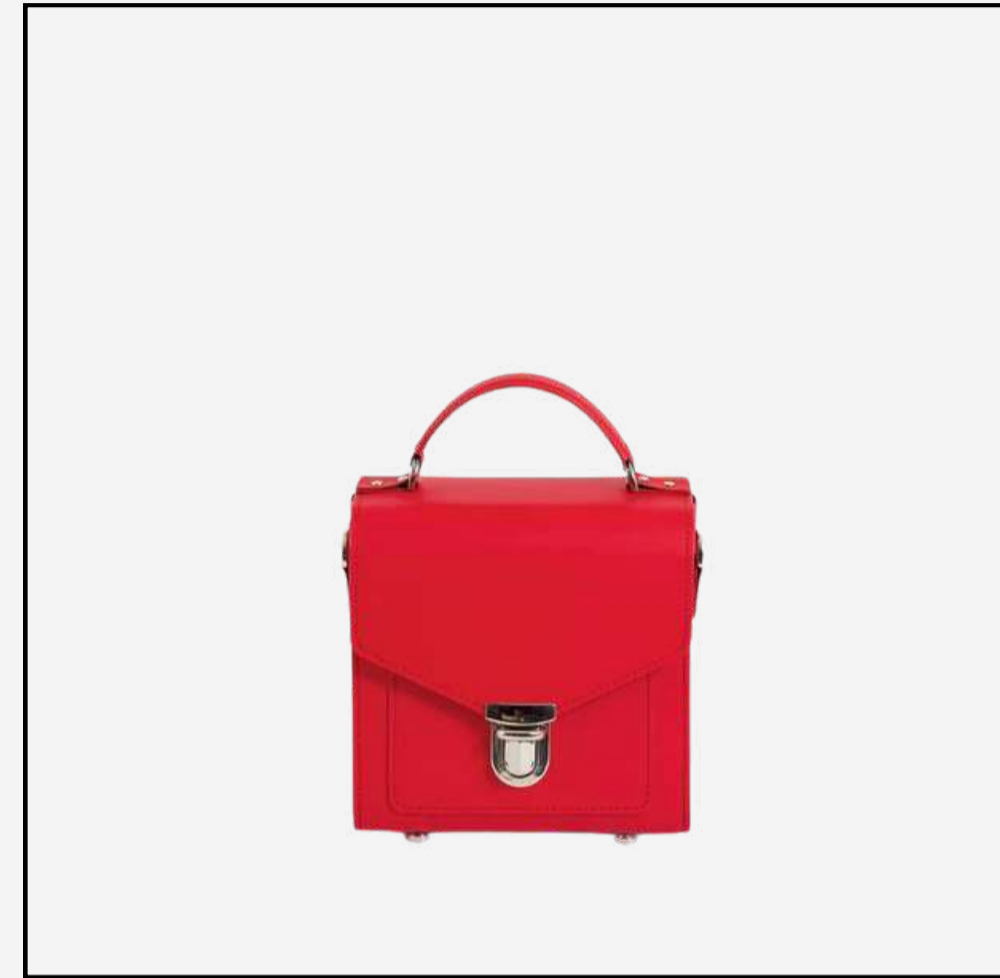

RAMONA

DISCOVER →



LOLA (THE ELDER ONE)

DISCOVER →



MARCELA

DISCOVER →



BERNARDA

DISCOVER →



MARCELINA

DISCOVER →



BERNARDITA

DISCOVER →

THEY NEVER MISS

## NOT SO BASIC BASICS

A collection of lightweight, versatile bags in different sizes to cover everyday needs without compromising design.

SHOP

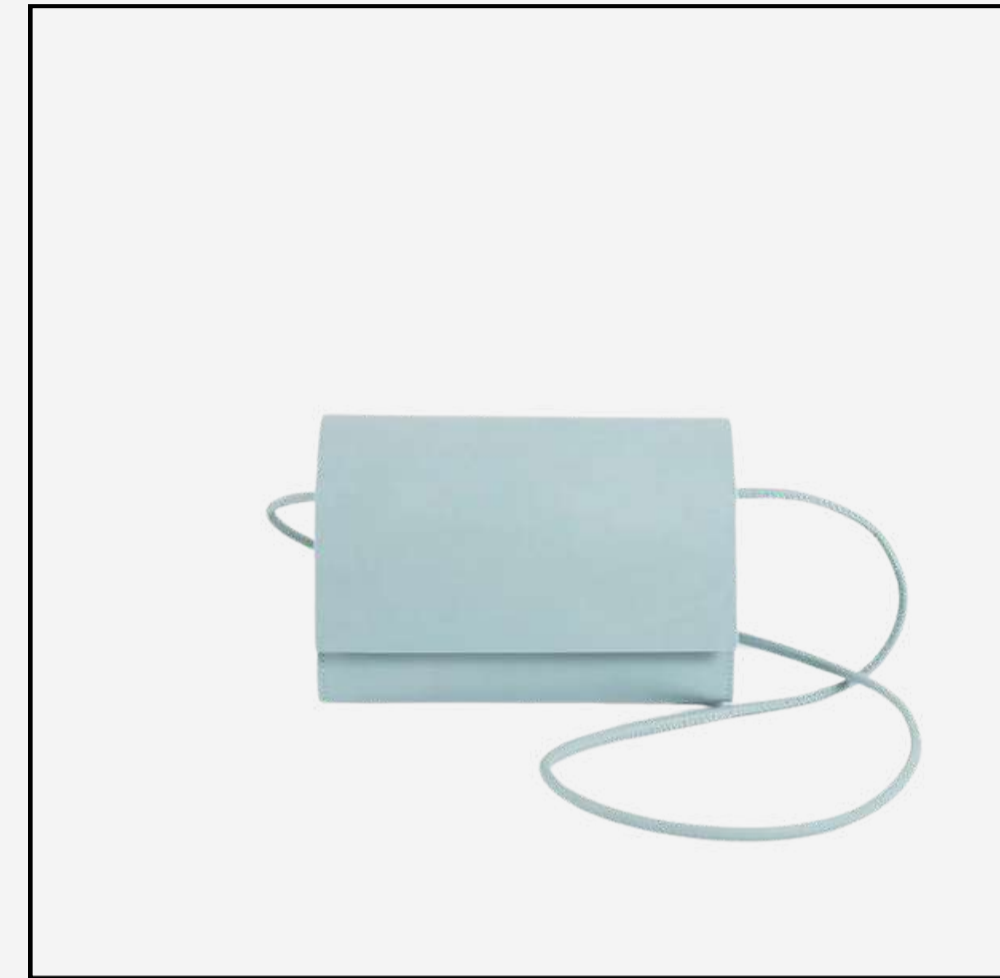

AMPARITO  
(THE ELDER ONE)

DISCOVER →

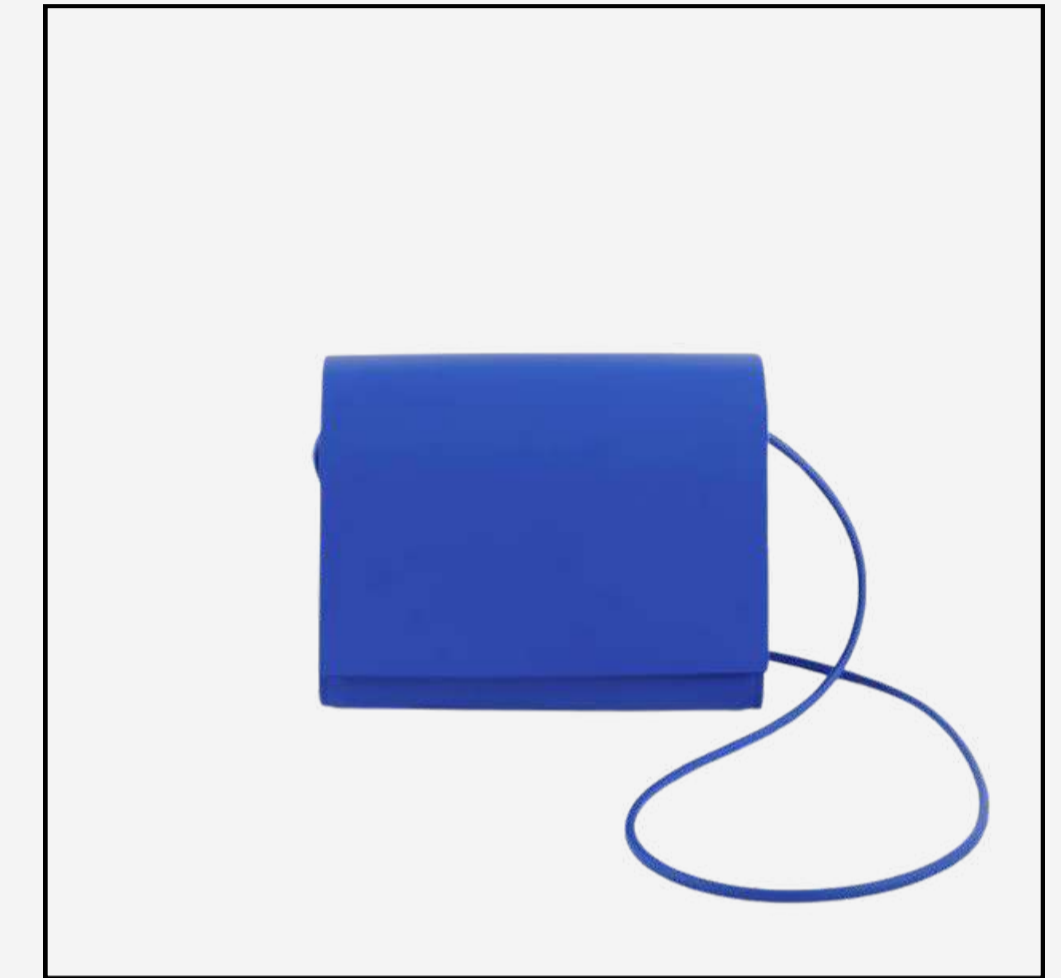

ENCARNITA  
(THE ELDER ONE)

DISCOVER →

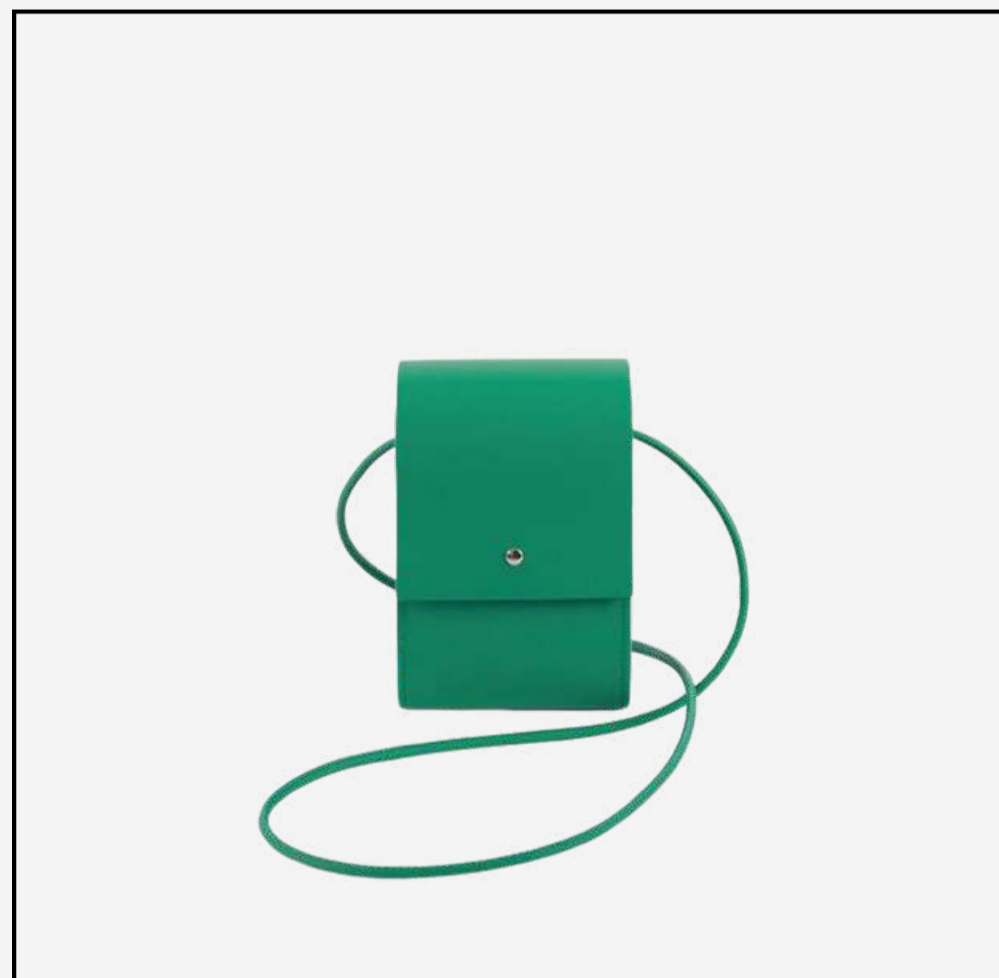

CARMELITA

DISCOVER →

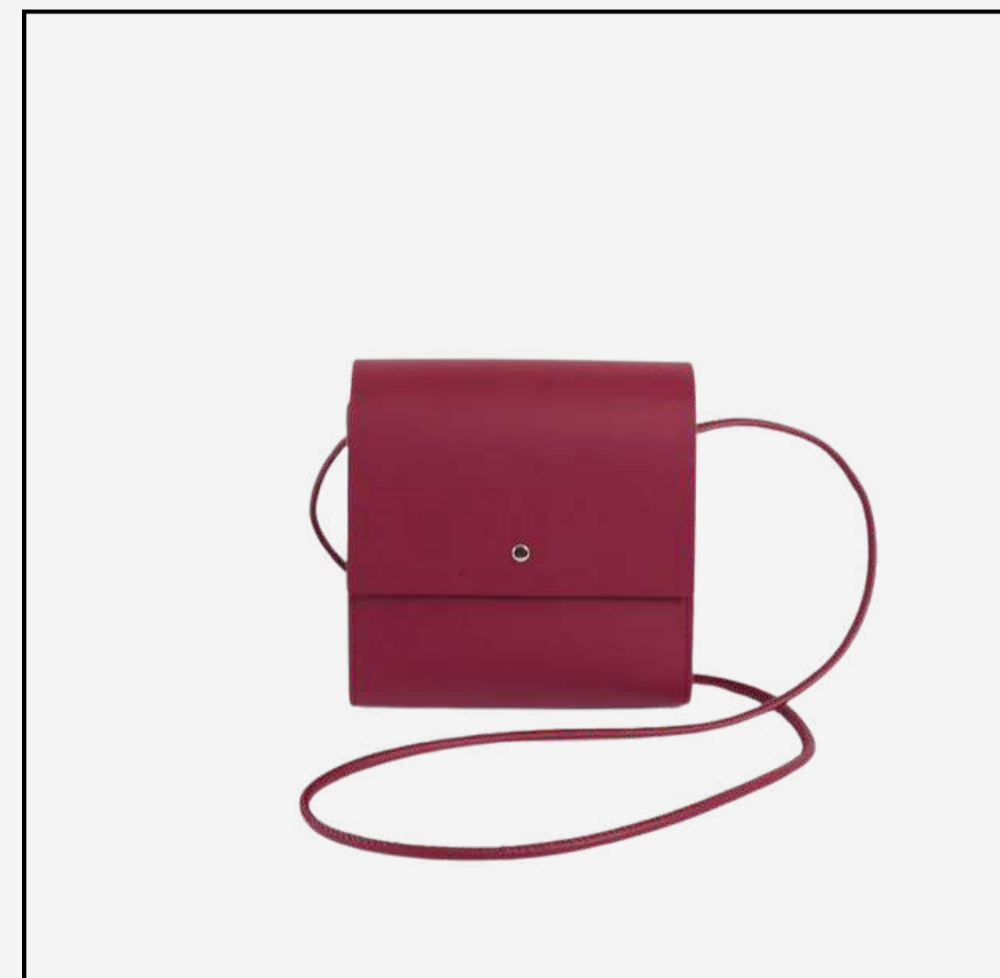

CARMELA

DISCOVER →



CARMEN

DISCOVER →



ACCESSORIES

DISCOVER →





BEST SELLER - N°1

## PAQUITA

Our best seller for years. Paquita is simply irresistible. A small but versatile bag that has been stealing hearts from minute one.

DISCOVER

BEST SELLER

# PAQUITA

- Magnet flap fastener (double)
- One inside pocket
- Finished and painted edges for a greater protection
- Adjustable cord-strap included (140 cm)
- Extra cord-straps available: 50 cm, 100 cm, 120 cm or 140 cm
- Matching shoulder bag pad

SHOP

EXTRAS

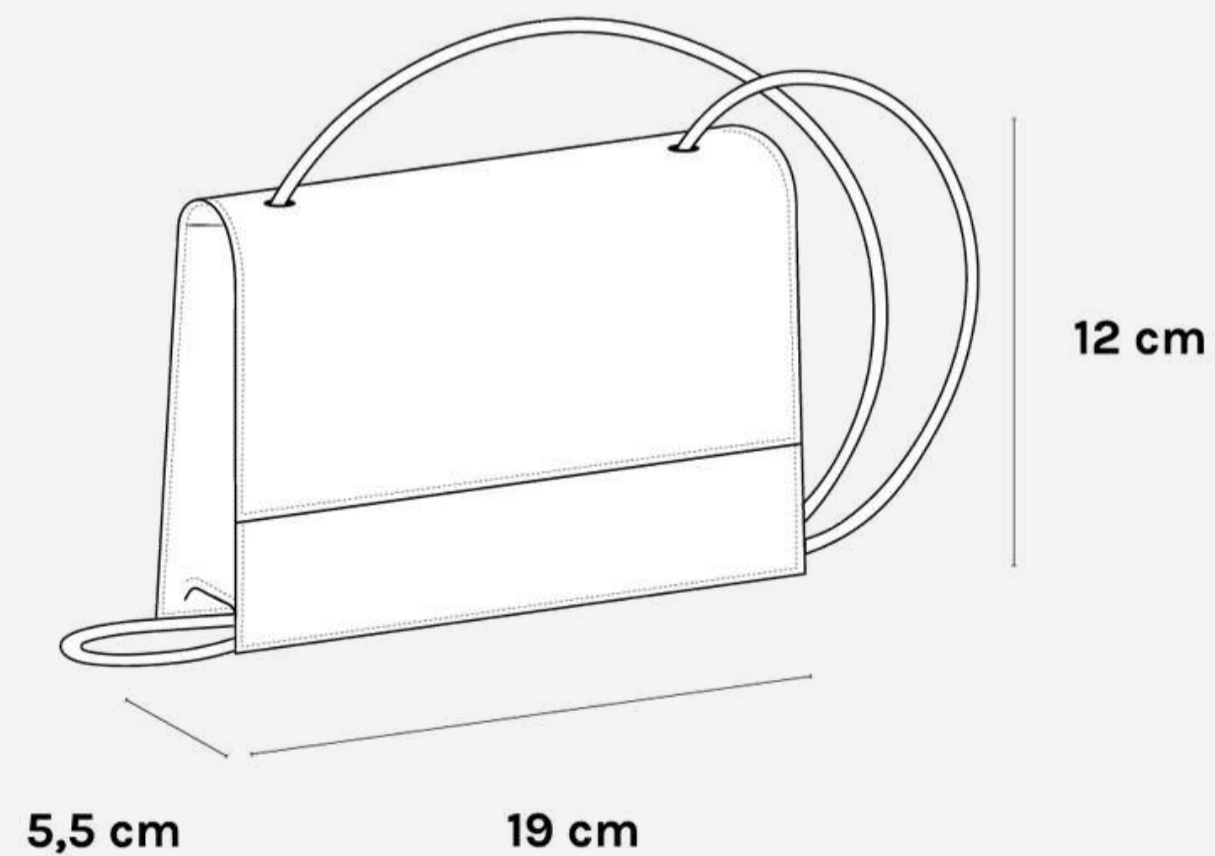

BRICK

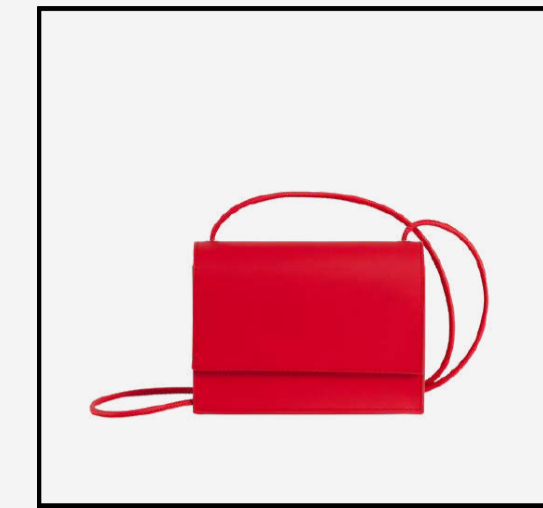

RED

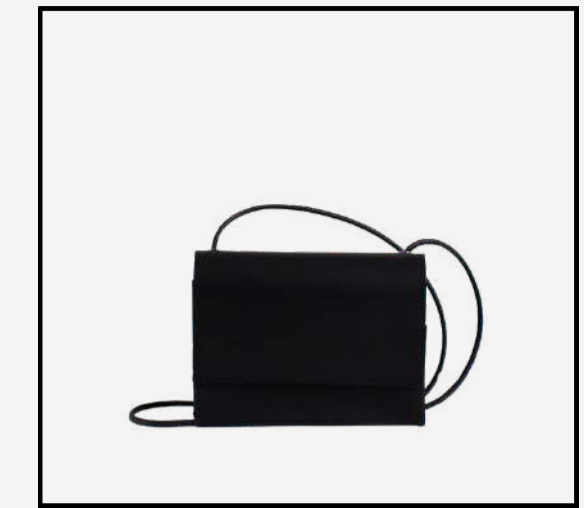

BOOM BLACK



NUDE



LIGHT-BLUE



WINE



CREAM



TANNED



NAVY

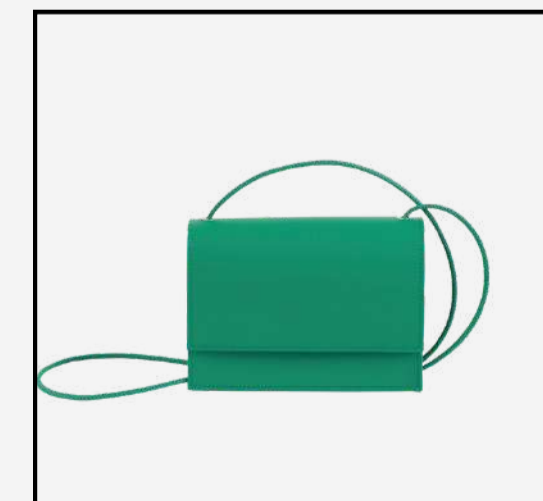

CLOVER GREEN

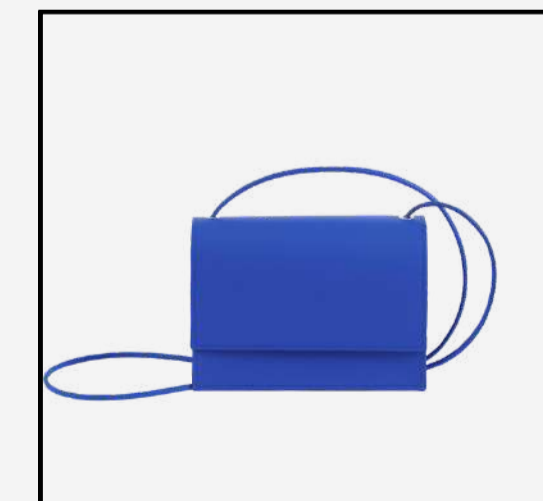

BIENHECHA BLUE



MAT BLACK





POSITIONS | \* The model is 1.70 m tall



50 cm



100 cm



120 cm

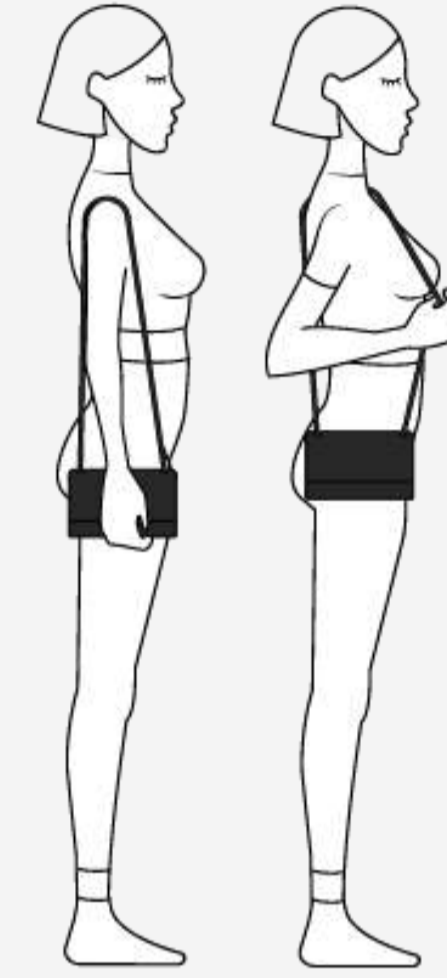

140 cm  
(INCLUDED)

BEST SELLER

## PAQUITA

SHOP

RETAIL PRICE: 149,95€

\*Sign in to your account to see your wholesale price



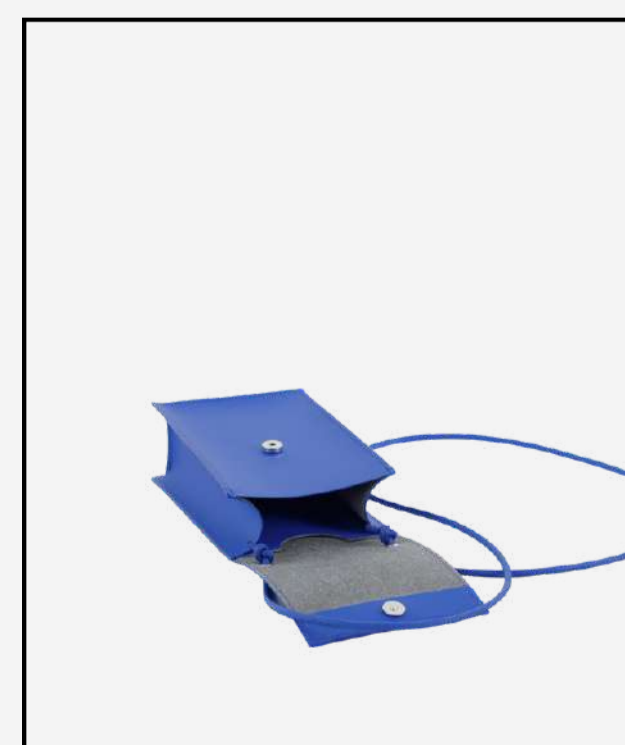

**BEST SELLER**

## **PACA**

Paca is that superversatile bag for carrying exactly what you need. It has become a top seller and one of the most unisex bags in the collection.

**DISCOVER**

BEST SELLER

# PACA

- Magnet flap fastener
- One inside pocket
- Finished and painted edges for a greater protection
- Adjustable cord-strap included (140 cm)
- Extra cord-straps available: 50 cm, 100 cm, 120 cm or 140 cm
- Matching shoulder bag pad

SHOP

EXTRAS

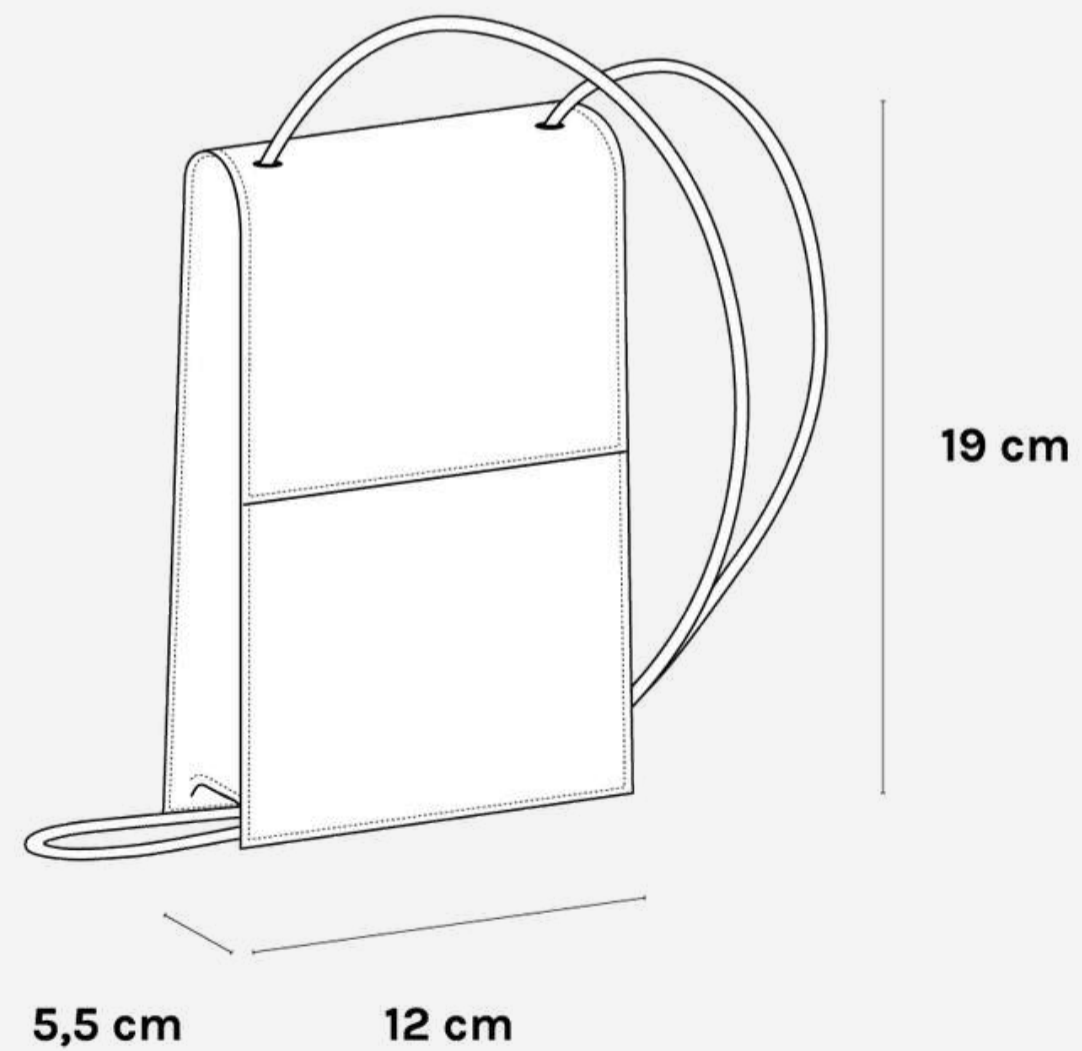

BRICK



RED

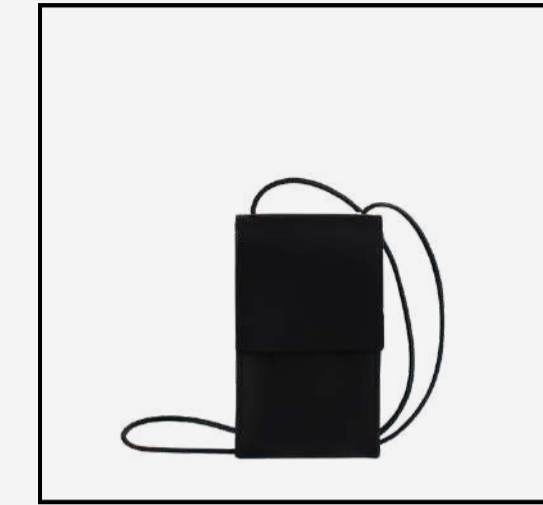

BOOM BLACK



NUDE



LIGHT-BLUE



WINE



CREAM



TANNED



NAVY



CLOVER GREEN

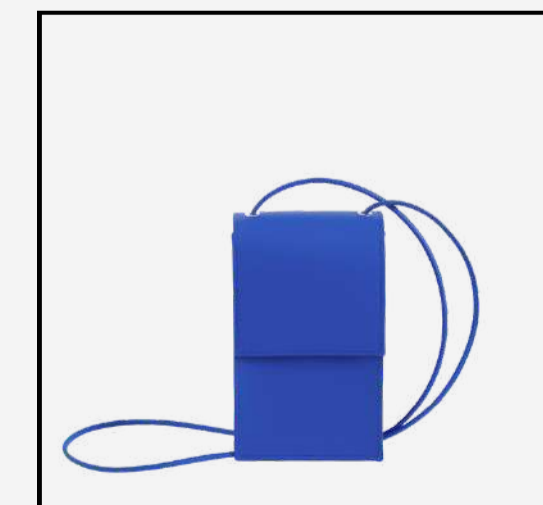

BIENHECHA BLUE



MAT BLACK





POSITIONS | \* The model is 1.70 m tall



50 cm



100 cm



120 cm

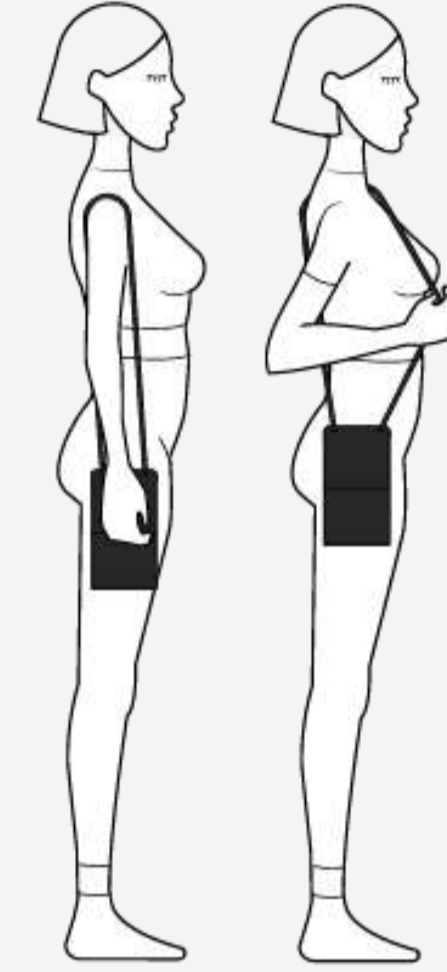

140 cm  
(INCLUDED)

BEST SELLER

**PACA**

SHOP

RETAIL PRICE: 149,95€

\*Sign in to your account to see your wholesale price



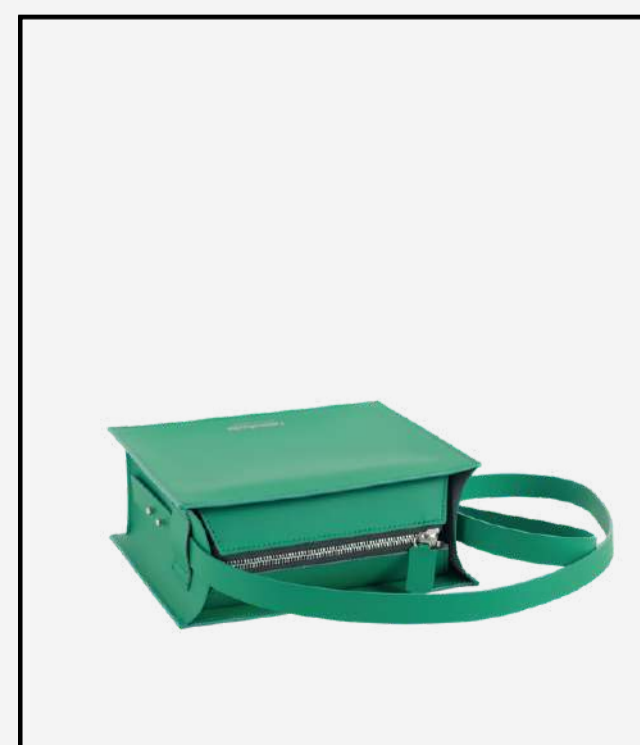
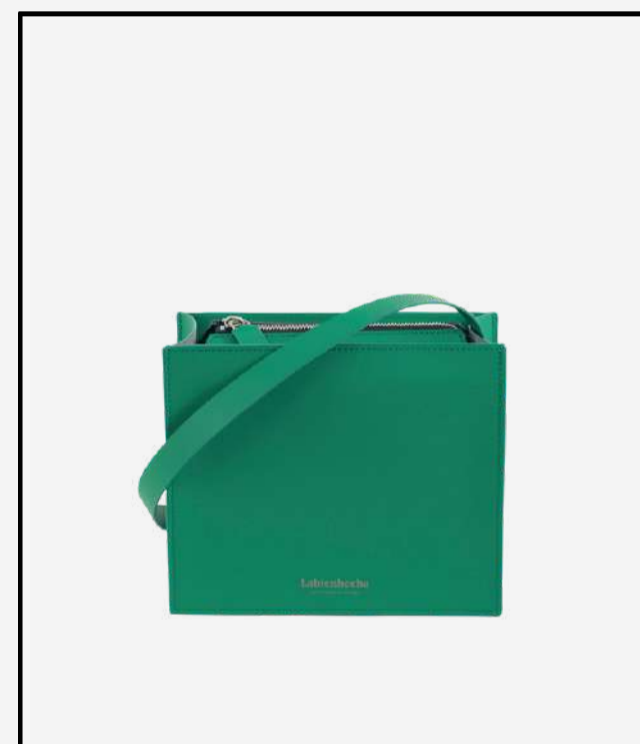

BEST SELLER

## PEPA

Our first design and the second best-selling bag in Labienhecha's history. A superversatile icon thanks to its interchangeable strap set.

DISCOVER



BEST SELLER

# PEPA

- Zip fastener YKK model
- Two inside pockets
- Finished and painted edges for a greater protection
- One adjustable strap included (140 cm)
- Extra straps available: 60 cm, 70 cm, 80 cm, 100 cm, 120 cm or 140 cm
- Matching accessories

SHOP

EXTRAS

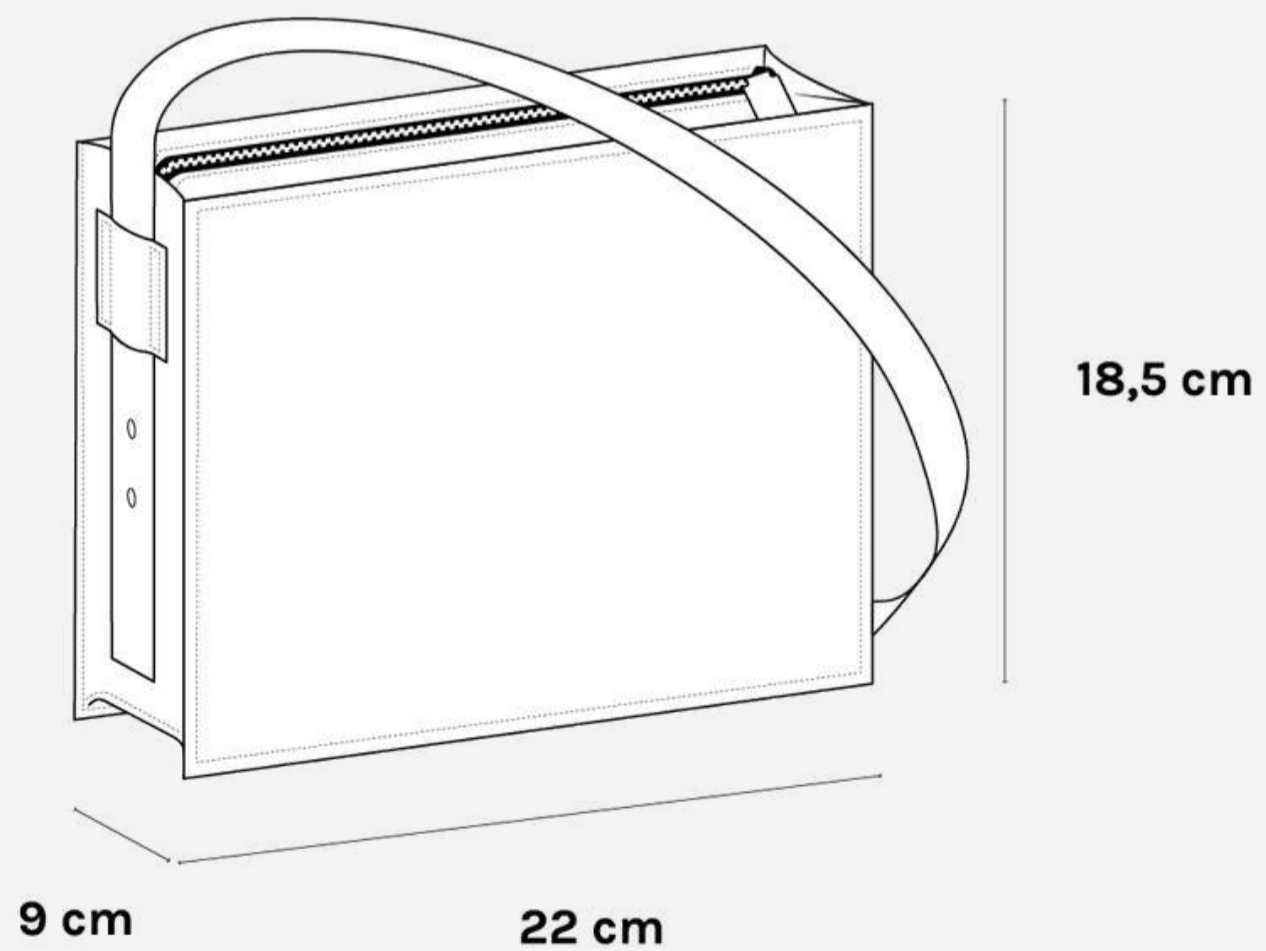

BRICK



RED



BOOM BLACK



NUDE



LIGHT-BLUE



WINE



CREAM



TANNED



NAVY



CLOVER GREEN



BIENHECHA BLUE



MAT BLACK





POSITIONS | \* The model is 1.70 m tall

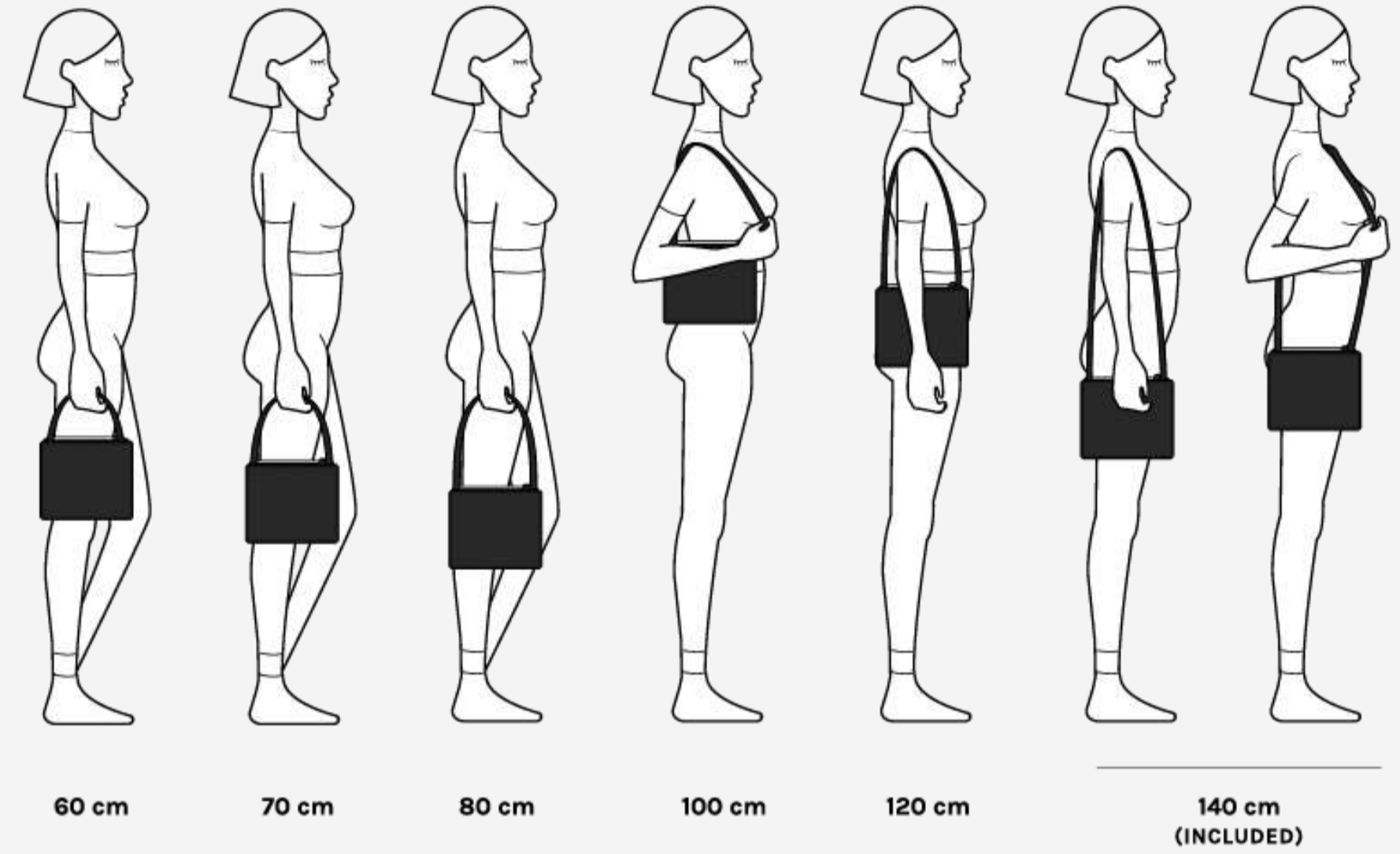

BEST SELLER

## PEPA

SHOP

RETAIL PRICE: 249,95€

\*Sign in to your account to see your wholesale price





**BIG SIZE**

## **JOSEFA (THE BIG PEPA)**

It is a TOP of the collection, especially for those who need that extra space on a daily basis. It is the perfect companion for the office and one of the unisex bags par excellence.

**DISCOVER**

BIG SIZE

## JOSEFA (THE BIG PEPA)

- Zip fastener YKK model
- Two inside pockets
- Finished and painted edges for a greater protection
- One adjustable strap included (140 cm)
- Extra straps available: 70 cm, 80 cm, 100 cm, 120 cm or 140 cm
- Matching accessories

SHOP

EXTRAS

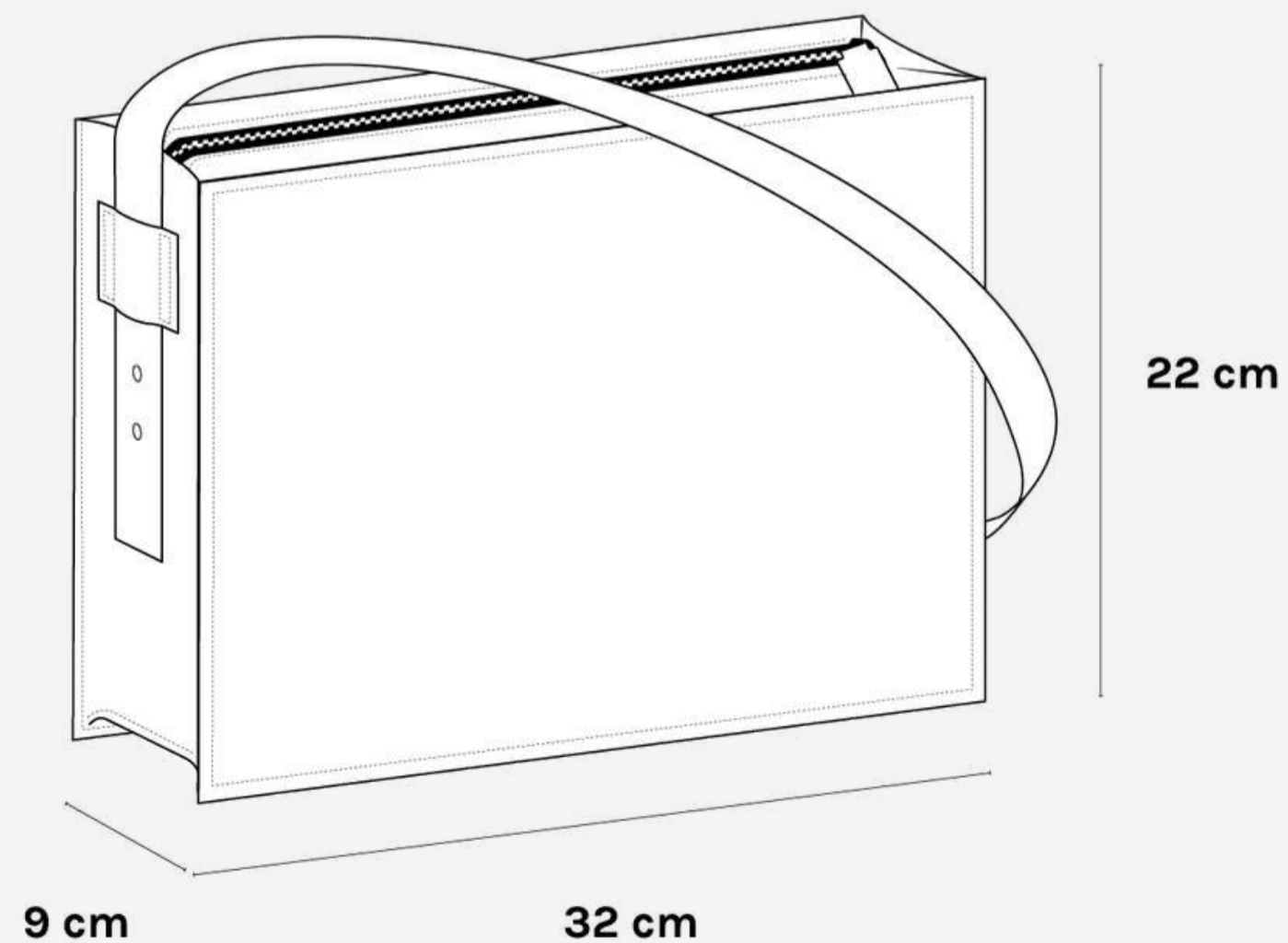

BRICK



RED



BOOM BLACK



NUPE



LIGHT-BLUE



WINE



CREAM



TANNED



NAVY



CLOVER GREEN



BIENHECHA BLUE



MAT BLACK





POSITIONS | \* The model is 1.70 m tall

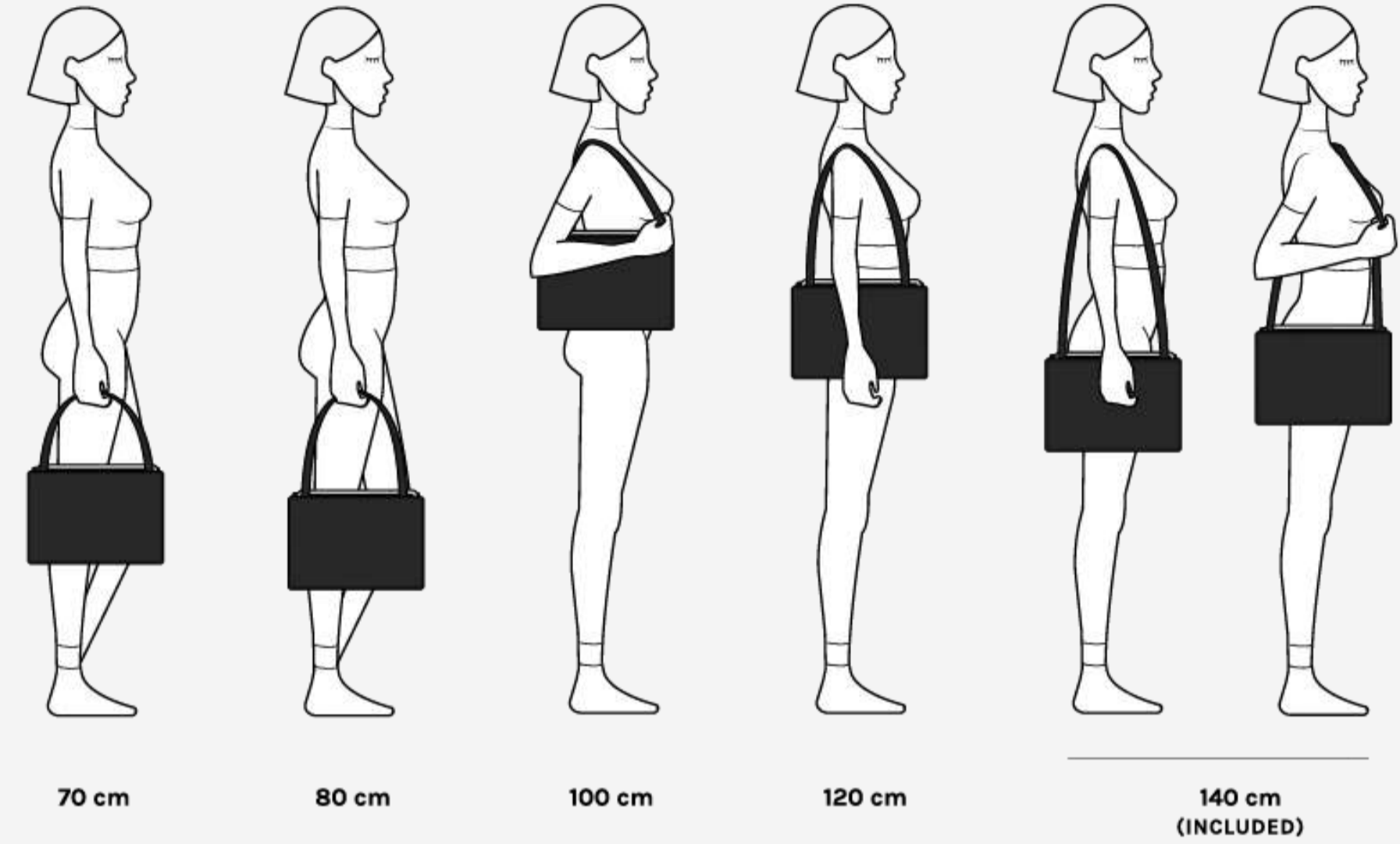

BIG SIZE

## JOSEFA (THE BIG PEPA)

SHOP

RETAIL PRICE: 299,95€

\*Sign in to your account to see your wholesale price



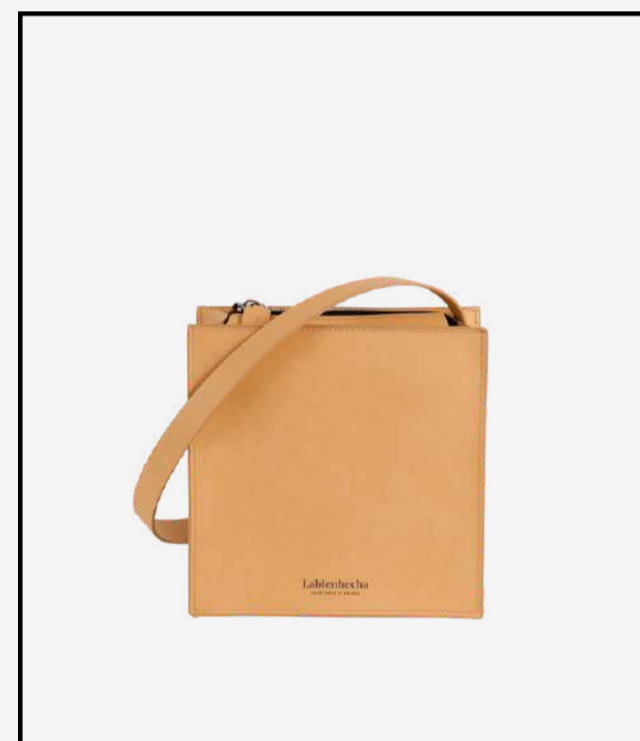

MINIMALIST

## SOFÍA (HIJA)

One of the most minimalist, clean models in our collection, bursting with personality. It has been with us since the beginning and still continues to win people's hearts.

DISCOVER



MINIMALIST

# SOFÍA (HIJA)

- Zip fastener YKK model
- Two inside pockets
- Finished and painted edges for a greater protection
- One adjustable strap included (140 cm)
- Extra straps available: 60 cm, 70 cm, 80 cm, 100 cm, 120 cm or 140 cm
- Matching accessories

SHOP

EXTRAS

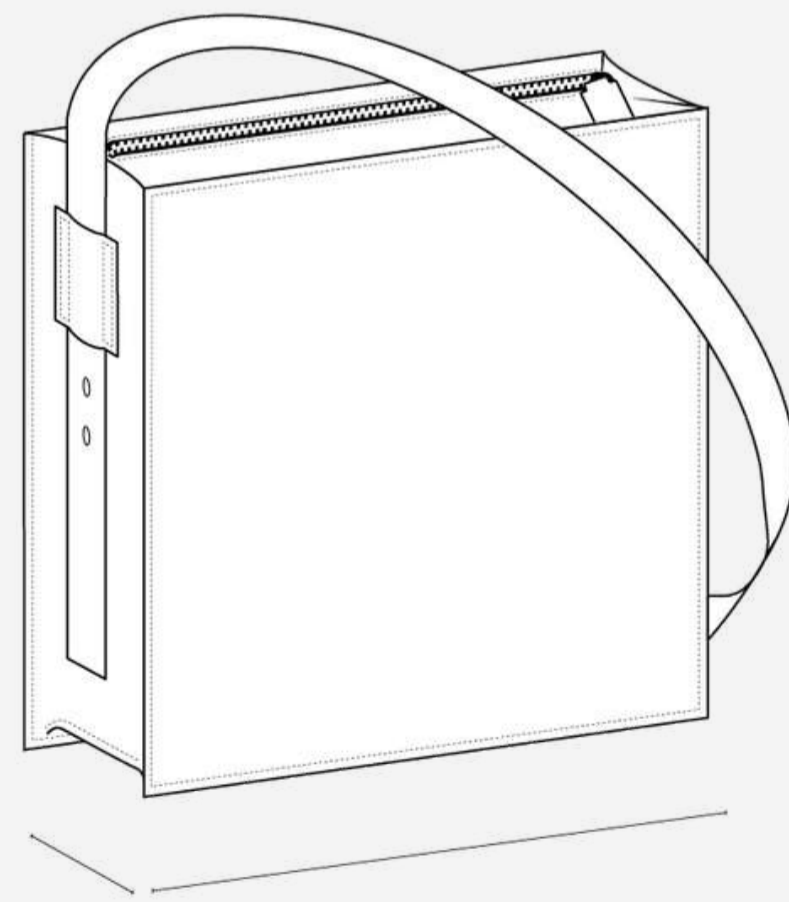

8,5 cm

20 cm

20 cm



BRICK



RED



BOOM BLACK



NUPE



LIGHT-BLUE



WINE



CREAM



TANNED



NAVY



CLOVER GREEN



BIENHECHA BLUE



MAT BLACK





POSITIONS | \* The model is 1.70 m tall

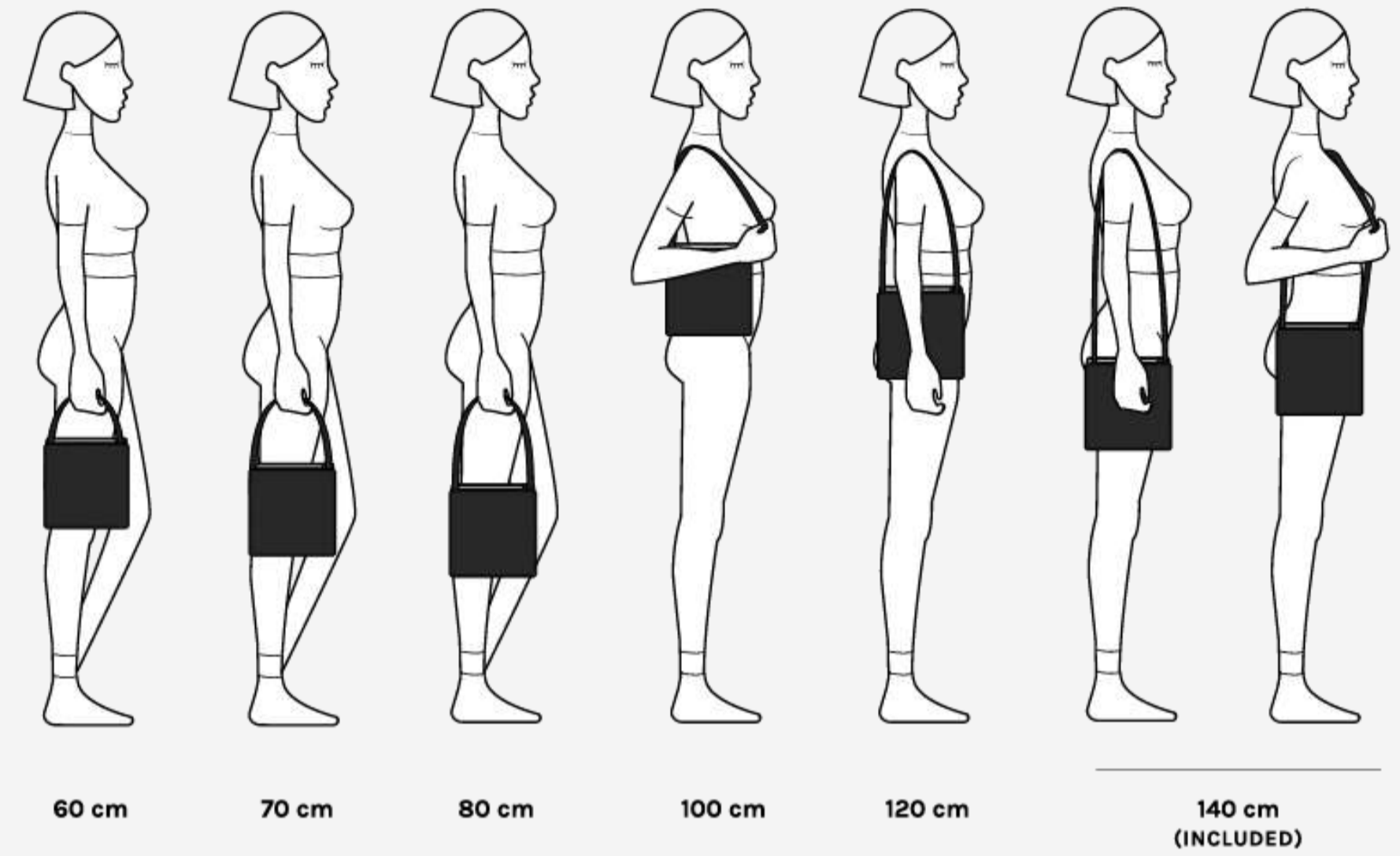

MINIMALIST

## SOFÍA (HIJA)

SHOP

RETAIL PRICE: 244,95€

\*Sign in to your account to see your wholesale price





EXTRA SPACE

## SOFÍA (MADRE)

One of those bags that can do it all. Spacious and structured, the bigger version of Sofía (hija) has been with us since the very beginning. Perfect for those who need extra space.

DISCOVER



EXTRA SPACE

# SOFÍA (MADRE)

- Zip fastener YKK model
- Two inside pockets
- Finished and painted edges for a greater protection
- Adjustable strap included (100 cm)
- Extra available straps: 70 cm, 80 cm, 100 cm, 120 cm or 140 cm
- Matching accessories

SHOP

EXTRAS

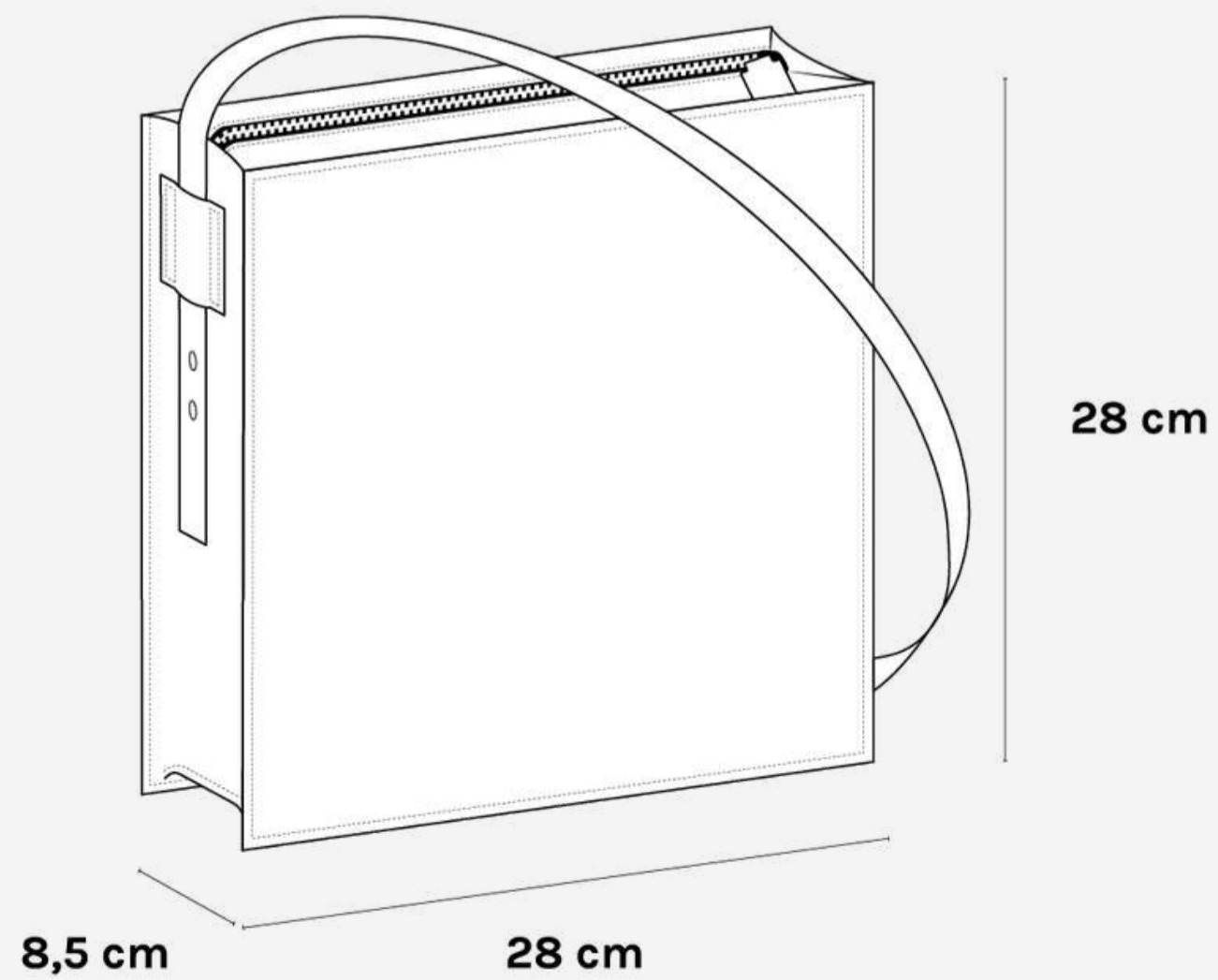

BRICK



RED



BOOM BLACK



NUDE



LIGHT-BLUE



WINE



CREAM



TANNED



NAVY



CLOVER GREEN



BIENHECHA BLUE



MAT BLACK





POSITIONS | \* The model is 1.70 m tall

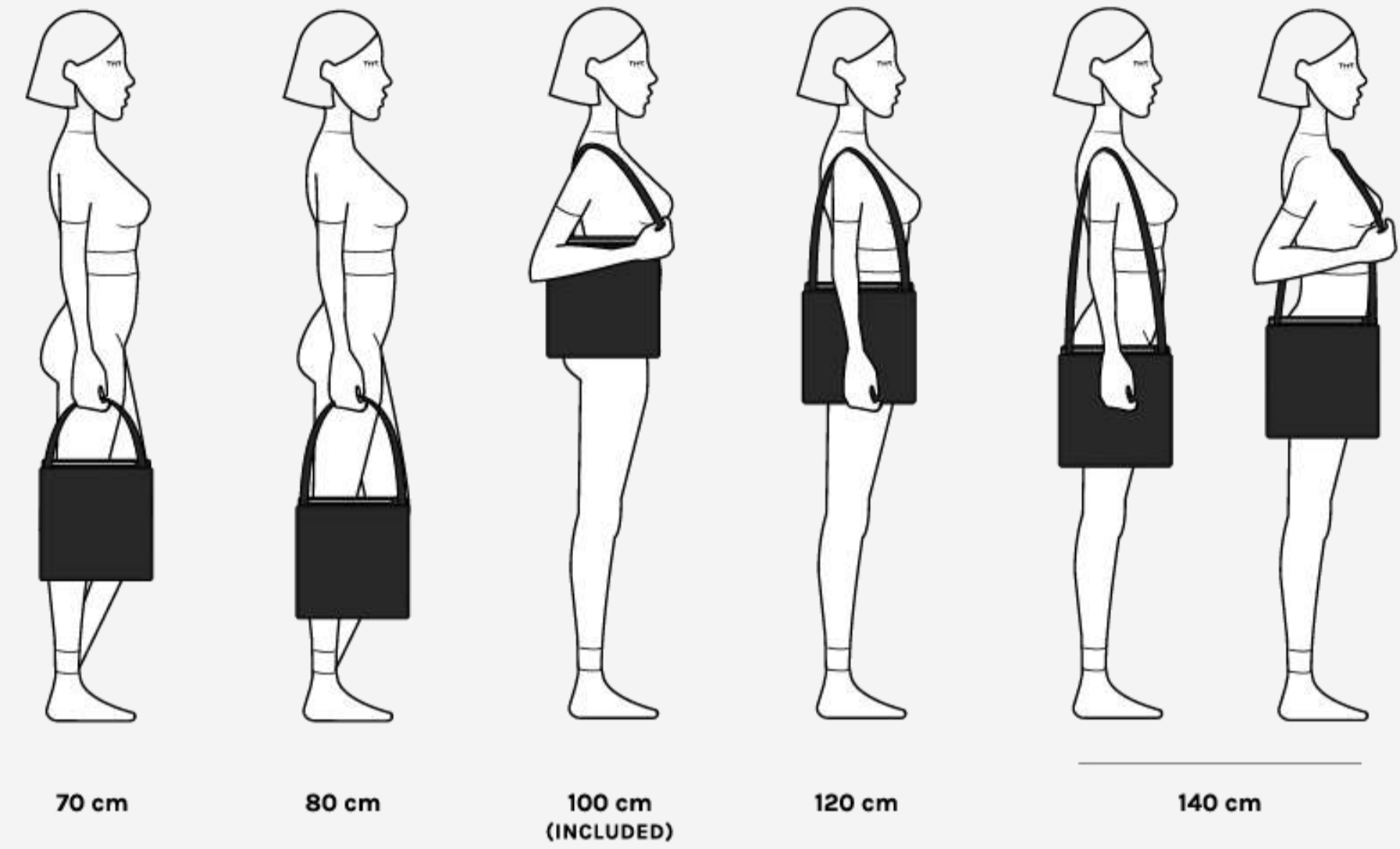

EXTRA SPACE

## SOFÍA (MADRE)

SHOP

RETAIL PRICE: 299,95€

\*Sign in to your account to see your wholesale price





BEST SELLER

## BERNARDITA

A half-moon shaped bag that radiates charm. Its pure and minimalist flap brings a touch of personality to complete any look.

DISCOVER



BEST SELLER

# BERNARDITA

- Magnet flat fastener
- Two inside pockets (one of them is a cardholder)
- Finished and painted edges for a greater protection
- One cord-strap included (140 cm)
- Extra cord-straps available: 50 cm, 100 cm, 120 cm or 140 cm
- Matching accessories

SHOP

EXTRAS

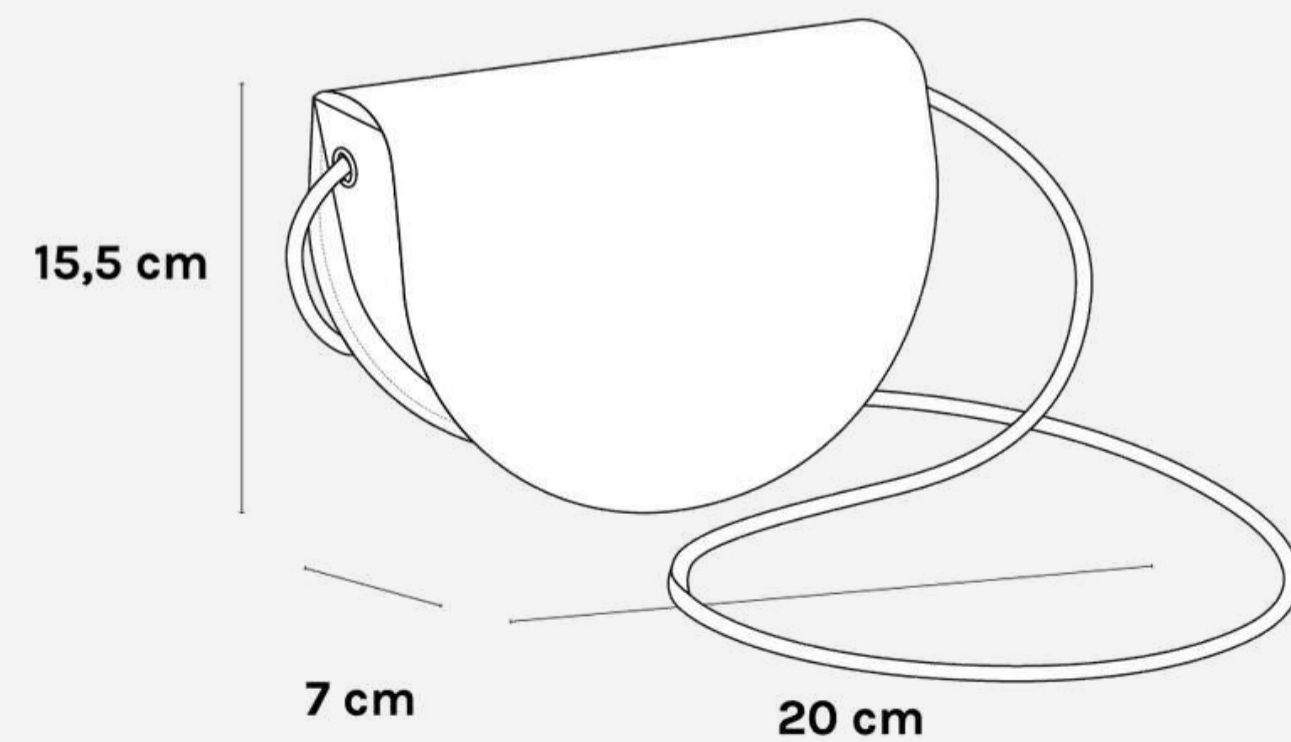

BRICK



RED



BOOM BLACK



NUDE



LIGHT-BLUE



WINE



CREAM



TANNED



NAVY



CLOVER GREEN



BIENHECHA BLUE



MAT BLACK





POSITIONS | \* The model is 1.70 m tall



50 cm



100 cm



120 cm



140 cm  
(INCLUDED)



BEST SELLER

## BERNARDITA

SHOP

RETAIL PRICE: 219,95€

\*Sign in to your account to see your wholesale price



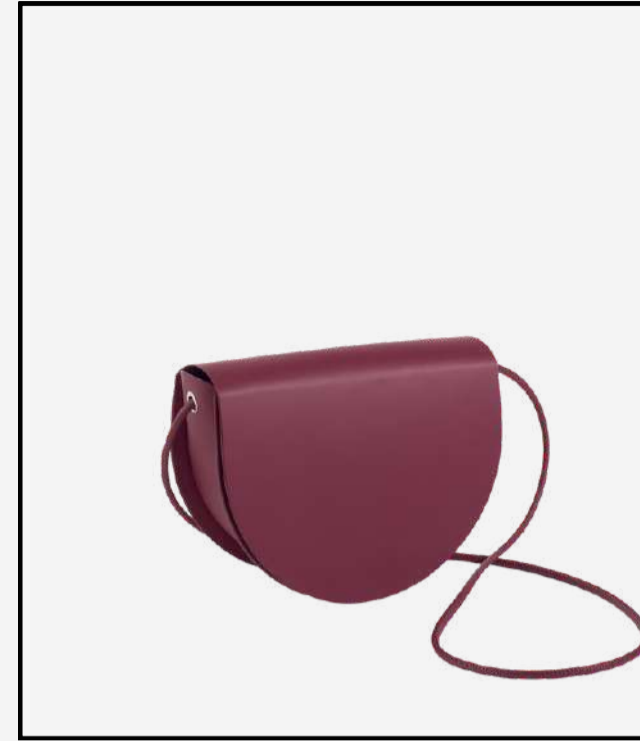
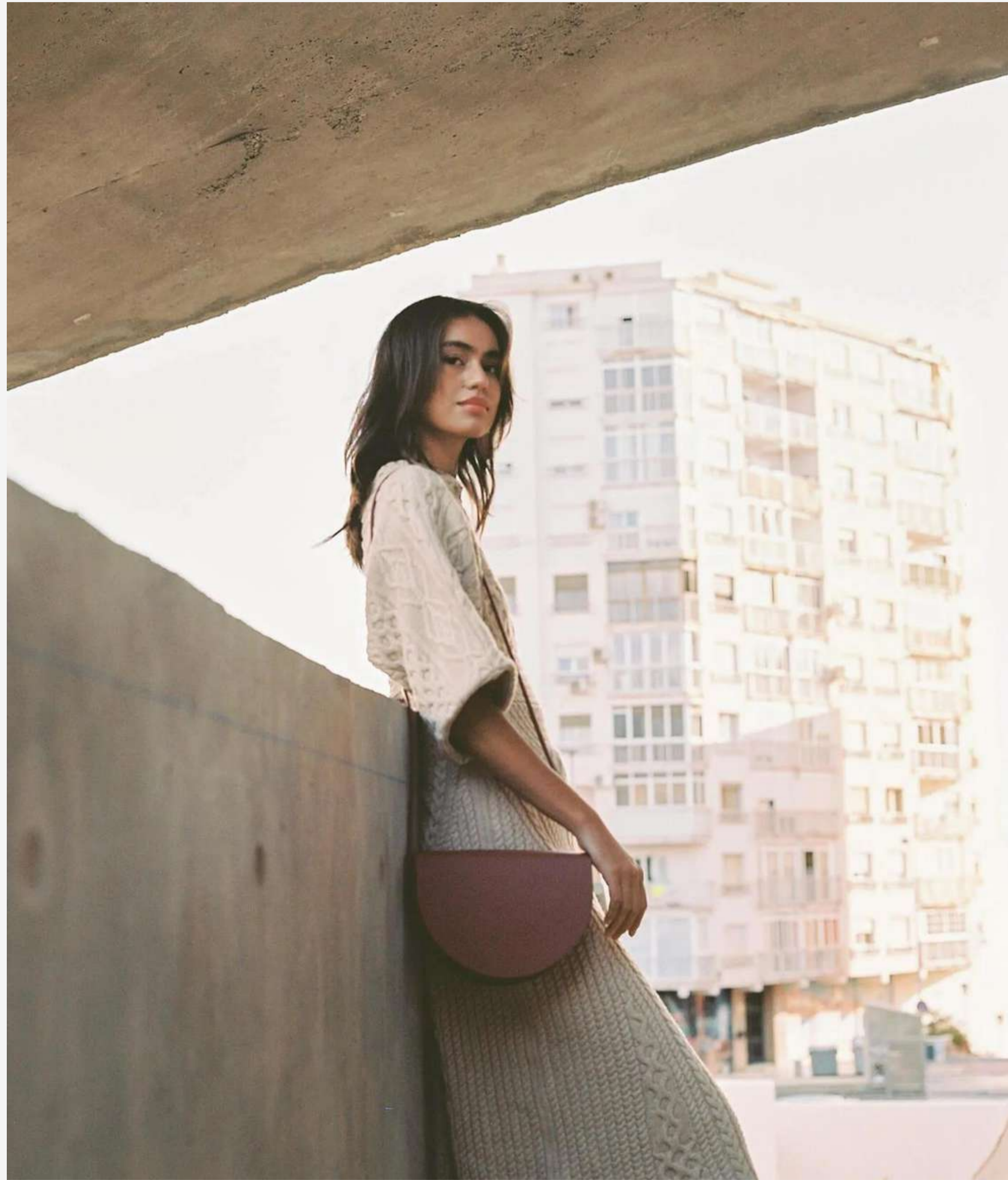

BEST SELLER

## BERNARDA

A half-moon shaped bag that radiates charm. Its pure and minimalist flap brings a touch of personality to complete any look. Bernardita's big sister.

DISCOVER



BEST SELLER

# BERNARDA

- Magnet flap fastener
- Two inside pockets (one of them is a cardholder)
- Finished and painted edges for a greater protection
- One cord-strap included (140 cm)
- Extra cord-straps available: 50 cm, 100 cm, 120 cm or 140 cm
- Matching accessories

SHOP

EXTRAS

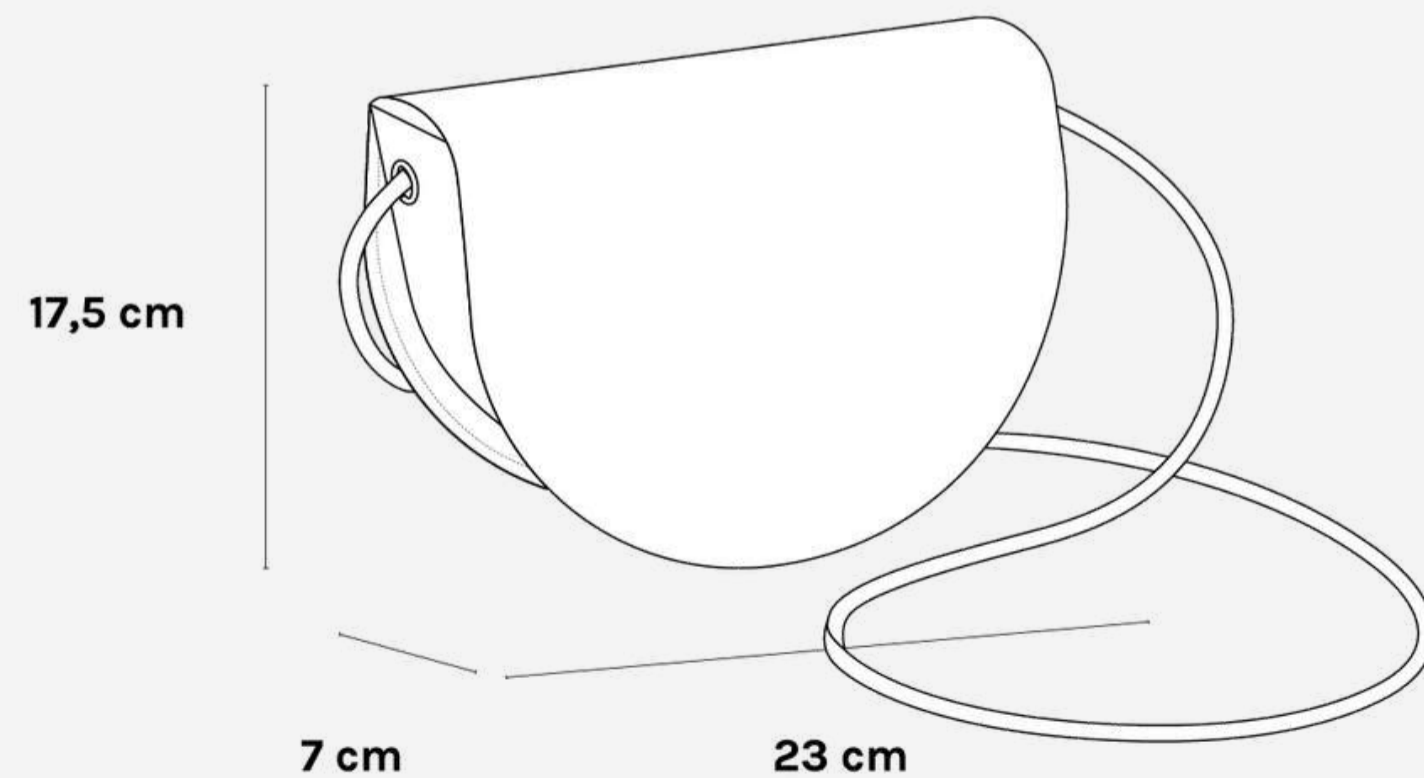

BRICK



RED



BOOM BLACK



NUDE



LIGHT-BLUE



WINE



CREAM



TANNED



NAVY



CLOVER GREEN



BIENHECHA BLUE



MAT BLACK





POSITIONS | \* The model is 1.70 m tall



50 cm



100 cm



120 cm



140 cm  
(INCLUDED)



BEST SELLER

## BERNARDA

SHOP

RETAIL PRICE: 239,95€

\*Sign in to your account to see your wholesale price



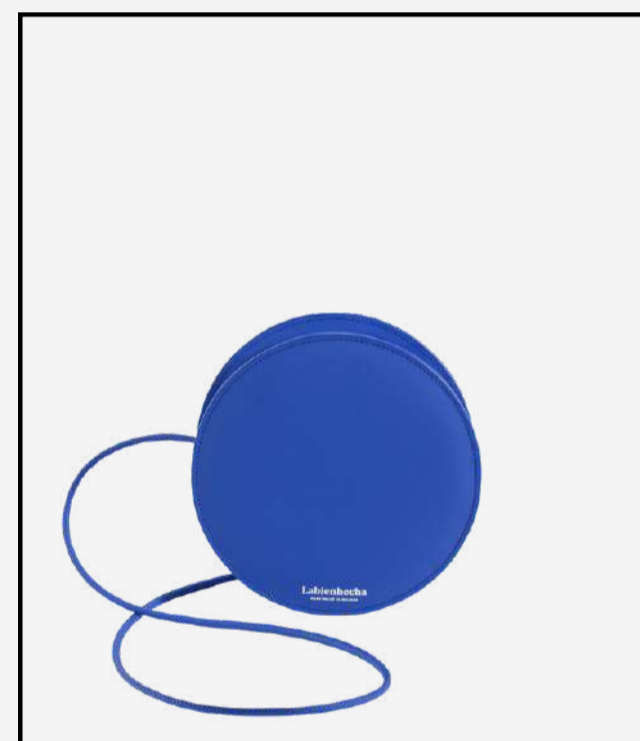

A LITTLE GEM

## MARCELINA

A small size bag to carry the essentials.  
Its perfectly round shape makes it very special.  
We are always told it is a collector's bag.

DISCOVER



A LITTLE GEM

# MARCELINA

- Zip fastener YKK model (very soft one)
- One inside pocket
- Finished and painted edges for a greater protectionn
- One cord-strap included (140 cm)
- Extra cord-straps available: 50 cm, 100 cm, 120 cm or 140 cm
- Matching accessories

SHOP

EXTRAS

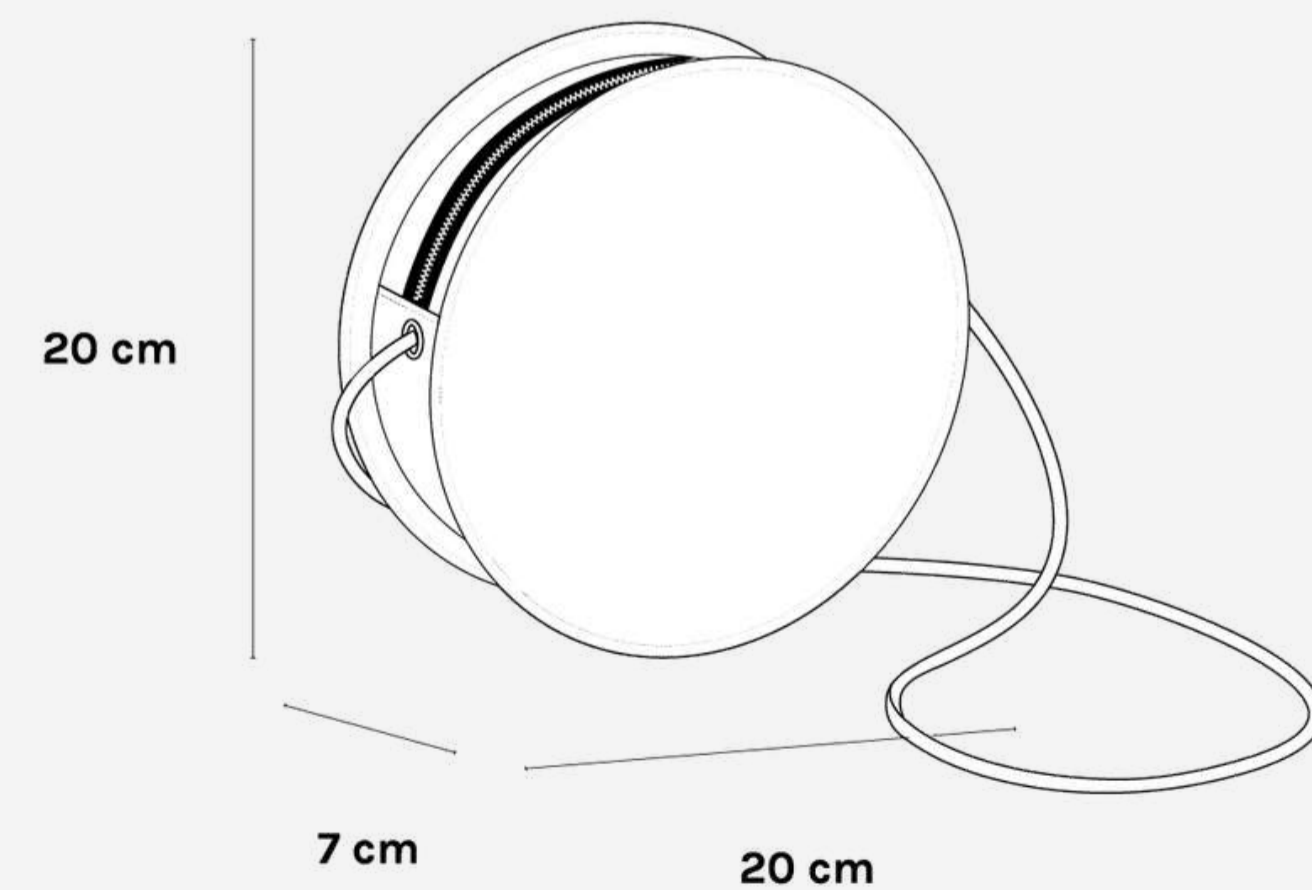

BRICK

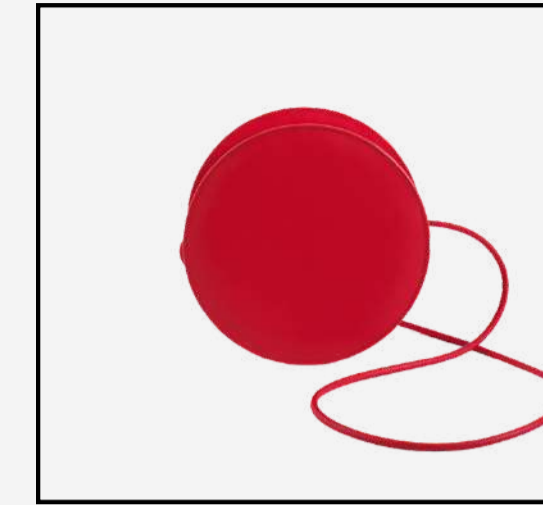

RED



BOOM BLACK



NUDE

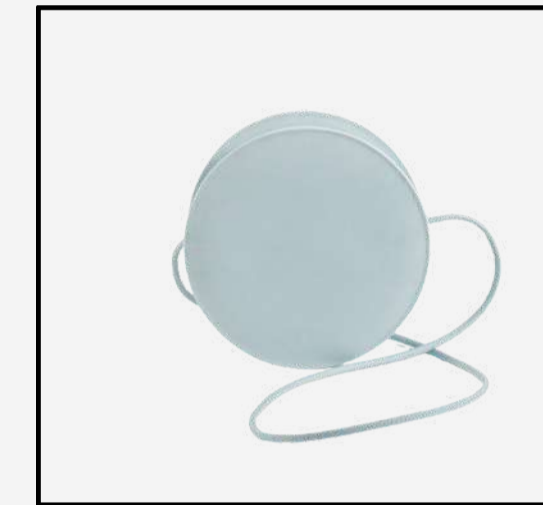

LIGHT-BLUE

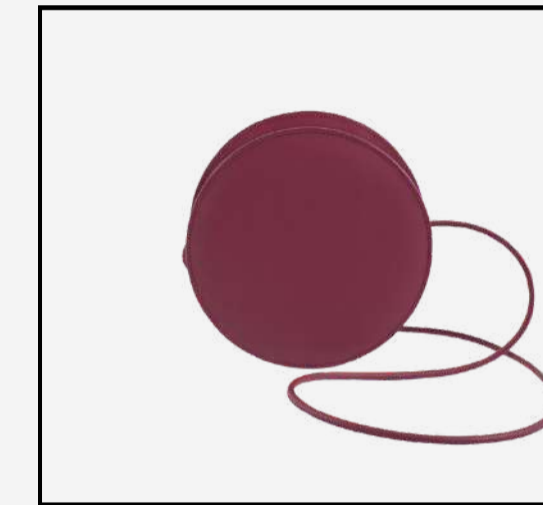

WINE



CREAM

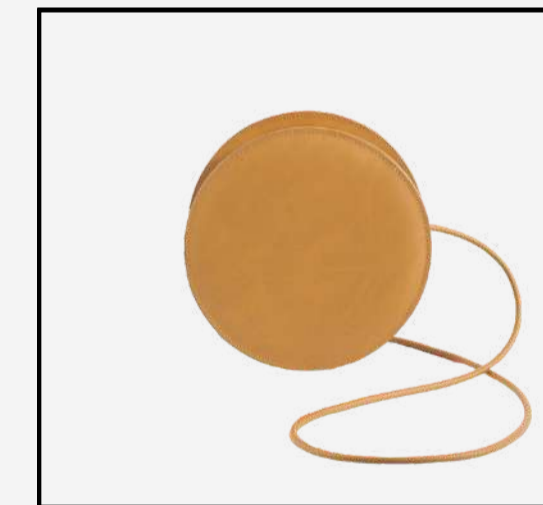

TANNED



NAVY

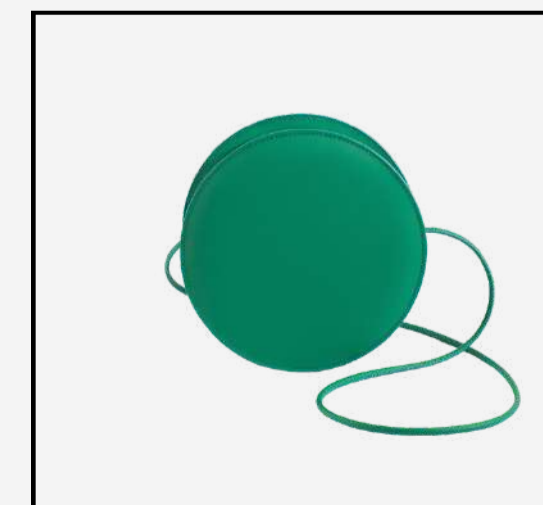

CLOVER GREEN



BIENHECHA BLUE



MAT BLACK





POSITIONS | \* The model is 1.70 m tall



50 cm



100 cm



120 cm



140 cm  
(INCLUDED)



A LITTLE GEM

## MARCELINA

SHOP

RETAIL PRICE: 269,95€

\*Sign in to your account to see your wholesale price



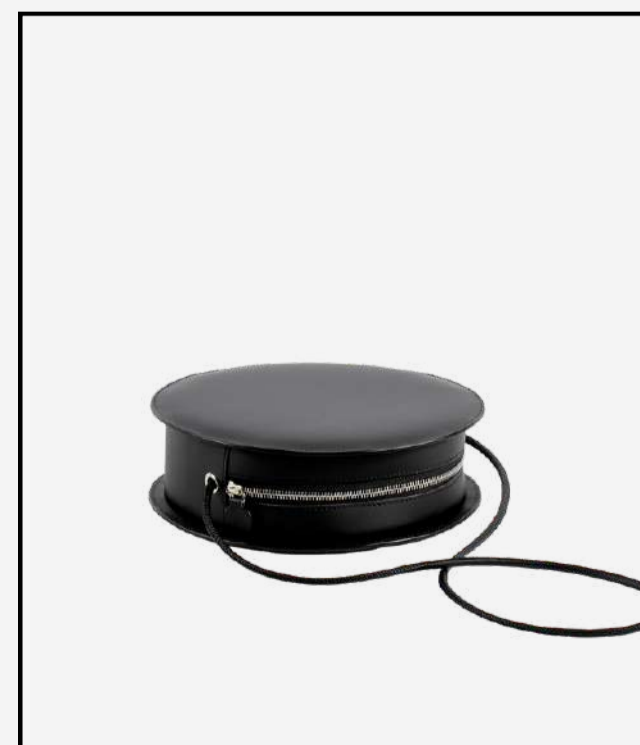
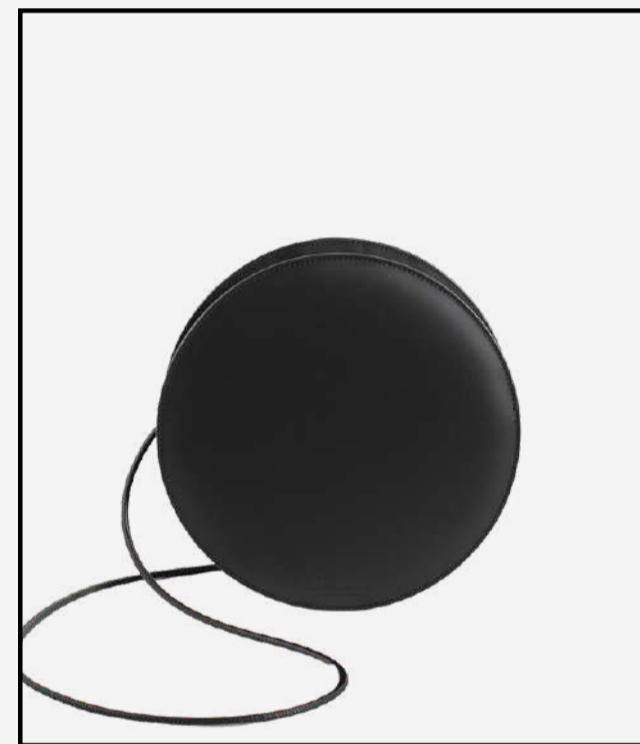

A GEM

## MARCELA

A medium-sized bag to carry the essentials. Its completely circular shape makes it very special. We are always told that it is a collector's bag. Marcelina's big sister.

DISCOVER



A GEM

# MARCELA

- Zip fastener YKK model (very soft one)
- One inside pocket
- Finished and painted edges for a greater protection
- One cord-strap included (140 cm)
- Extra cord-straps available: 50 cm, 100 cm, 120 cm or 140 cm
- Matching accessories

SHOP

EXTRAS

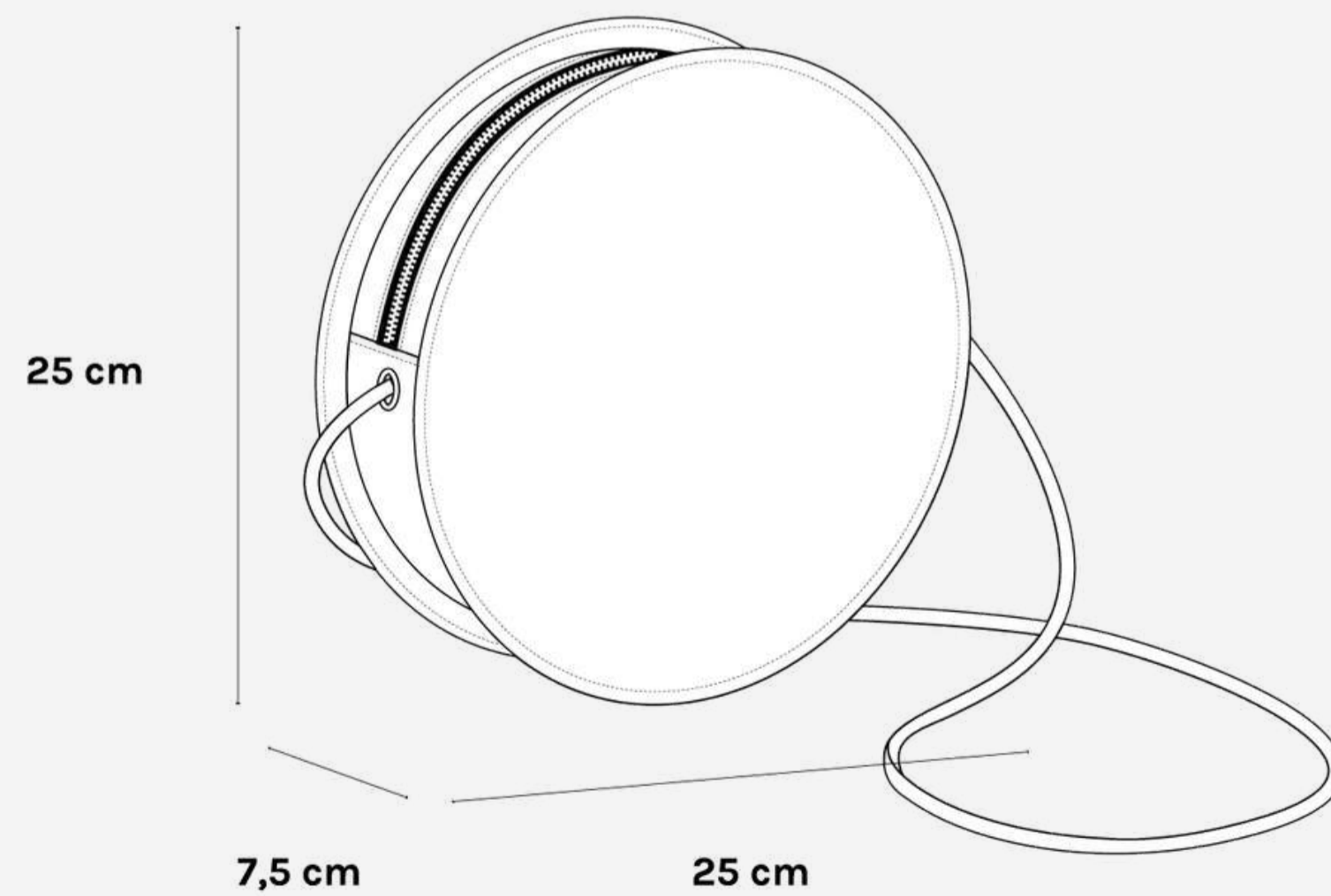

BRICK



RED

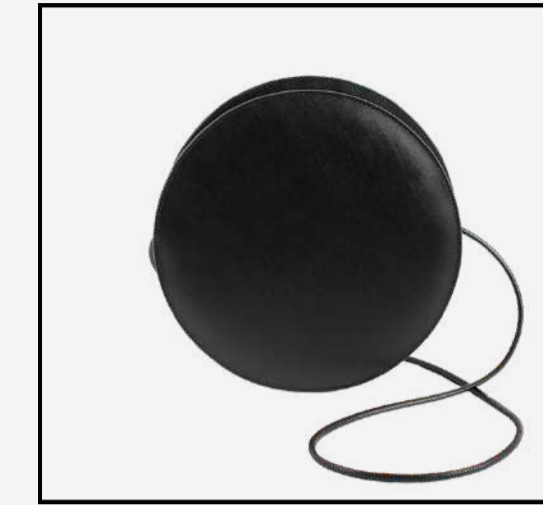

BOOM BLACK



NUDE



LIGHT-BLUE

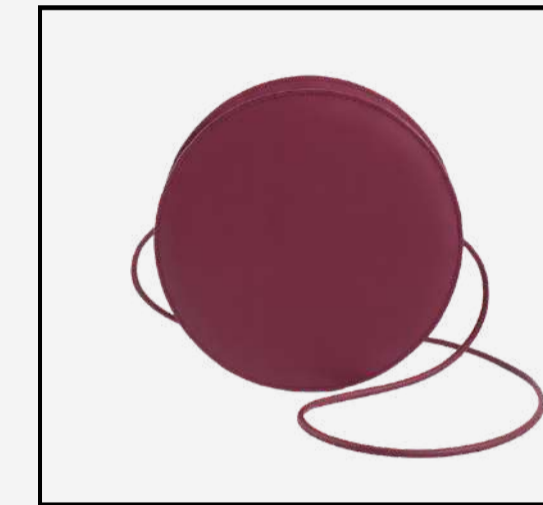

WINE



CREAM



TANNED

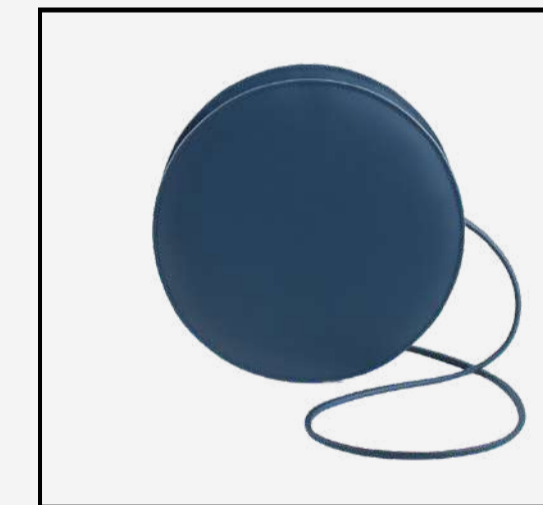

NAVY



CLOVER GREEN

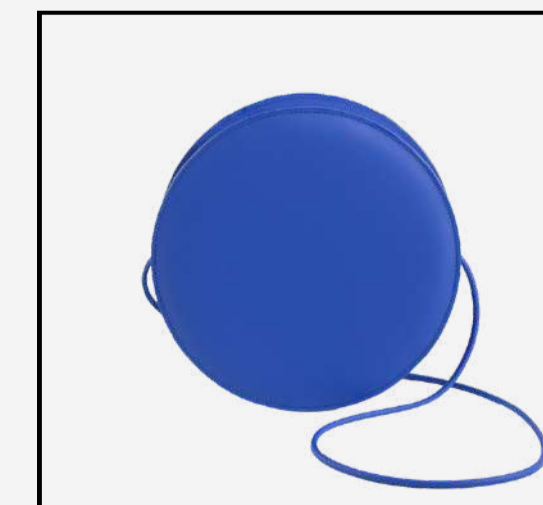

BIENHECHA BLUE



MAT BLACK





POSITIONS | \* The model is 1.70 m tall



50 cm



100 cm



120 cm

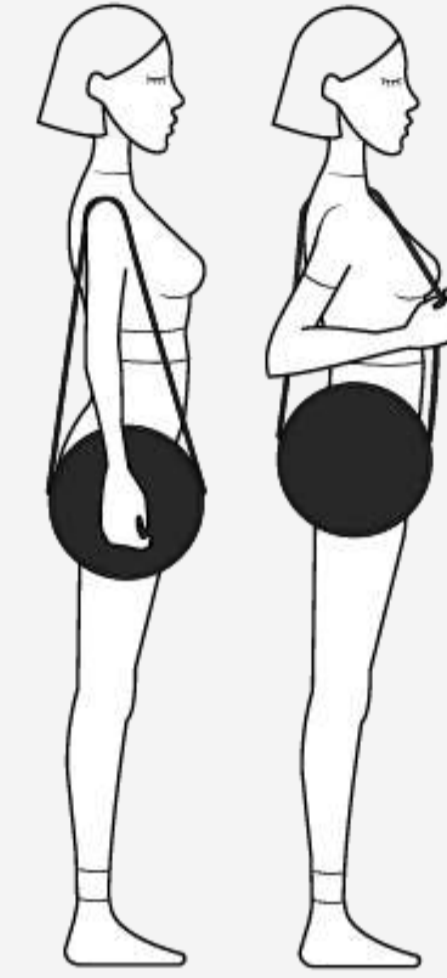

140 cm  
(INCLUDED)

A GEM

## MARCELA

SHOP

RETAIL PRICE: 299,95€

\*Sign in to your account to see your wholesale price



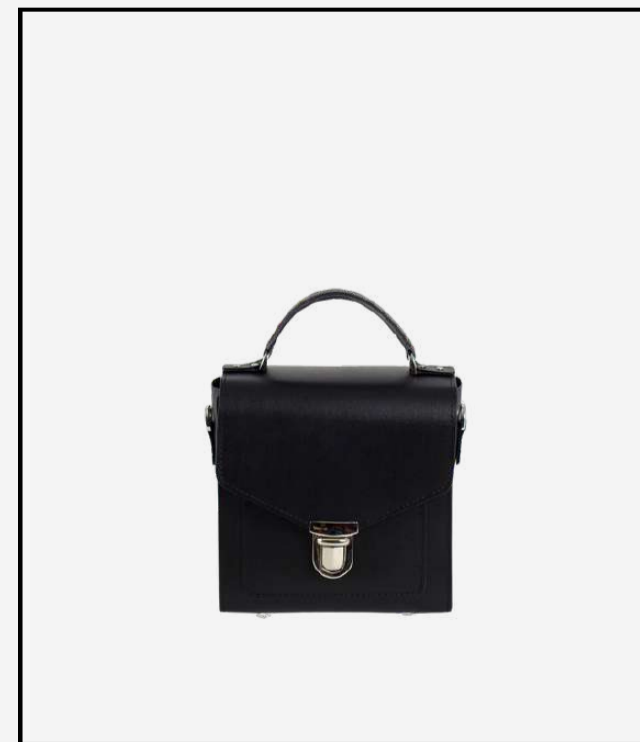
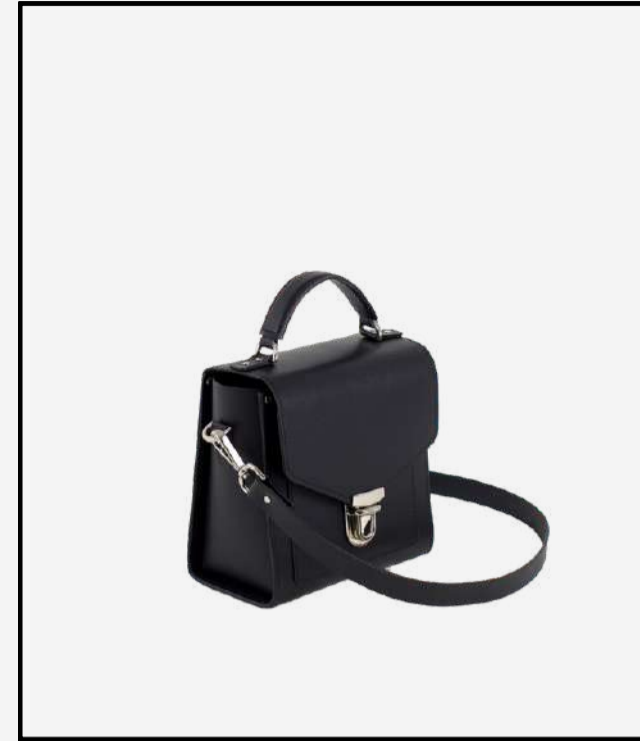

BEST SELLER

## RAMONA

One of the jewels in the crown. One of the most desired. Available in all colours and in two sizes. Extra options.

DISCOVER



BEST SELLER

# RAMONA

- Buckle flap fastener
- Two inside pockets (one of them is a cardholder)
- Finished and painted edges for a greater protection
- Reinforced base and flap to keep its shape
- Nickle free metal trimmings in the bas
- One carabiner strap included (120 cm)
- Extra straps available

SHOP

EXTRAS

LA GRANDE

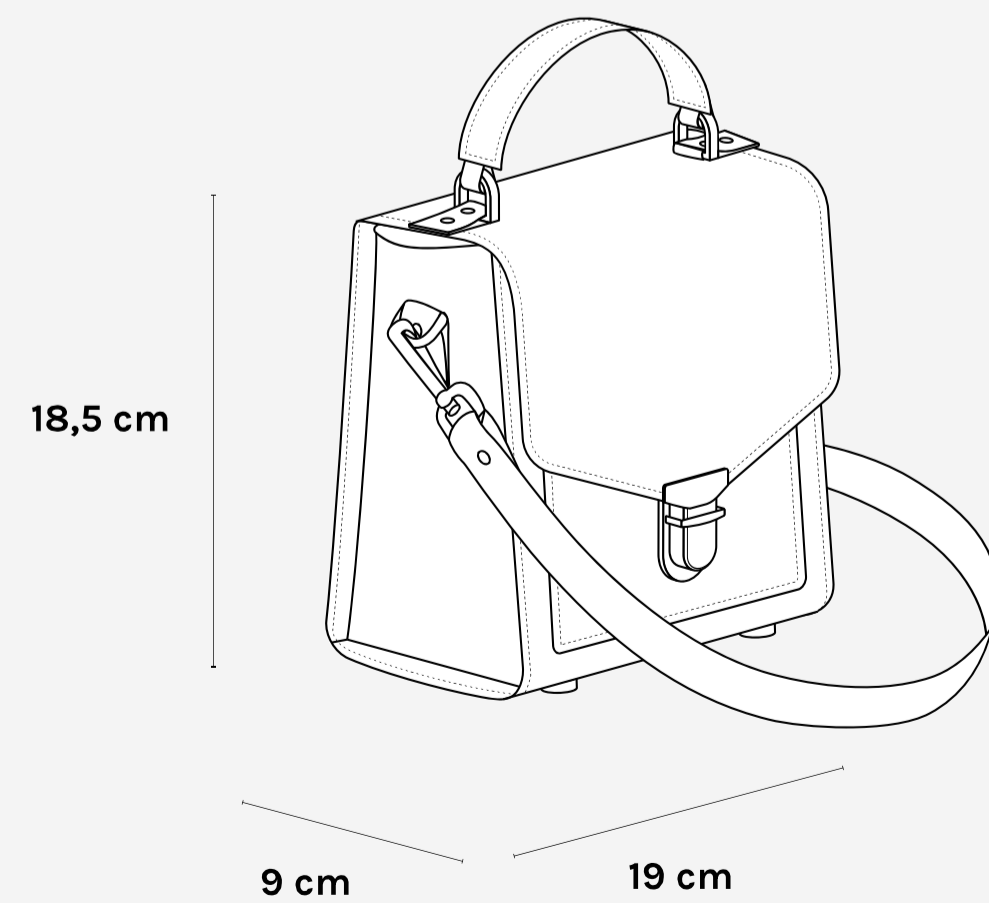

LA CHICA

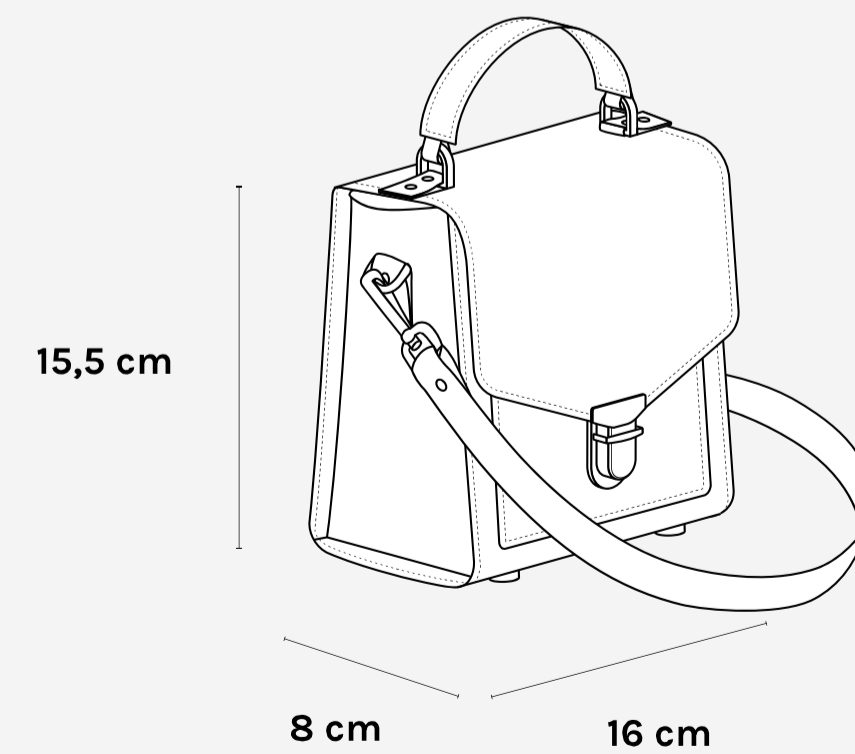

BRICK

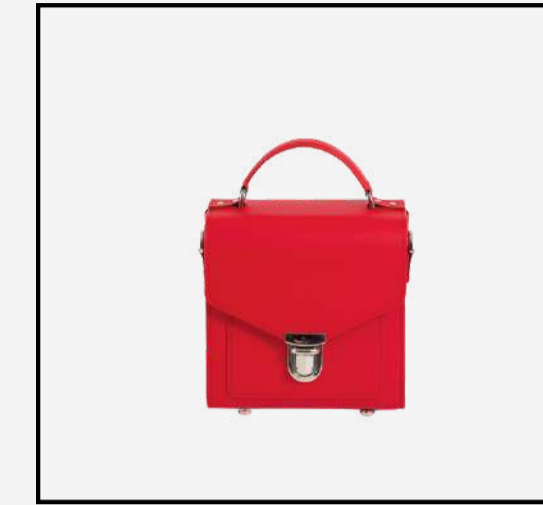

RED

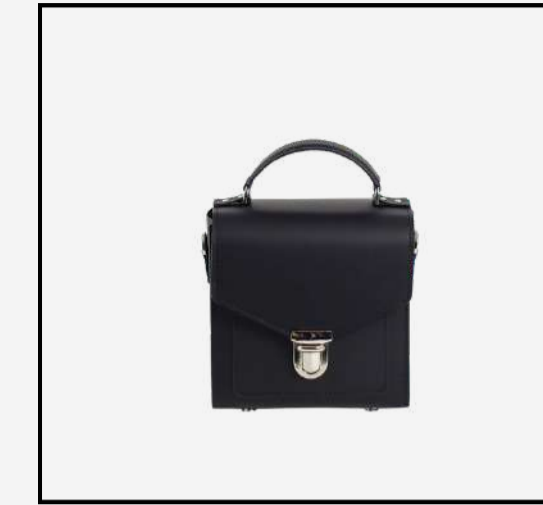

BOOM BLACK



NUDE



LIGHT-BLUE



WINE



CREAM



TANNED

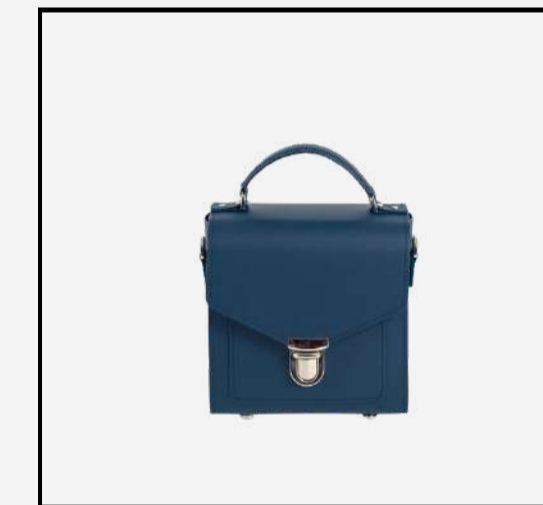

NAVY

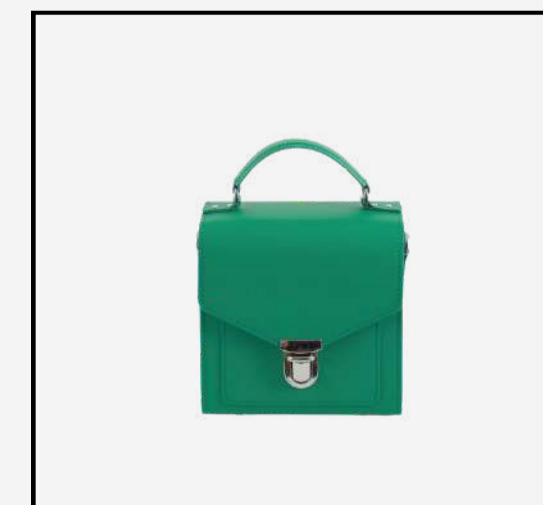

CLOVER GREEN

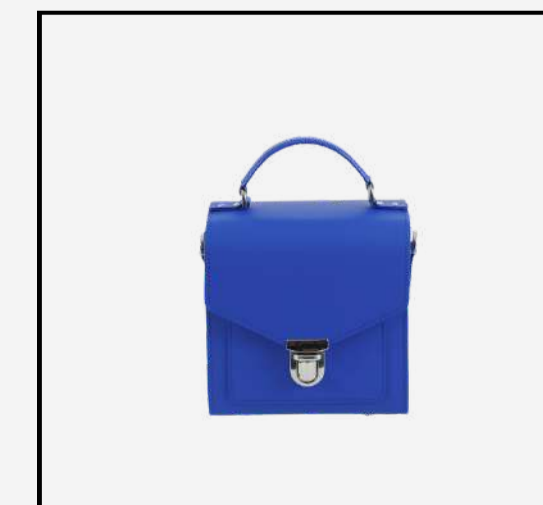

BIENHECHA BLUE

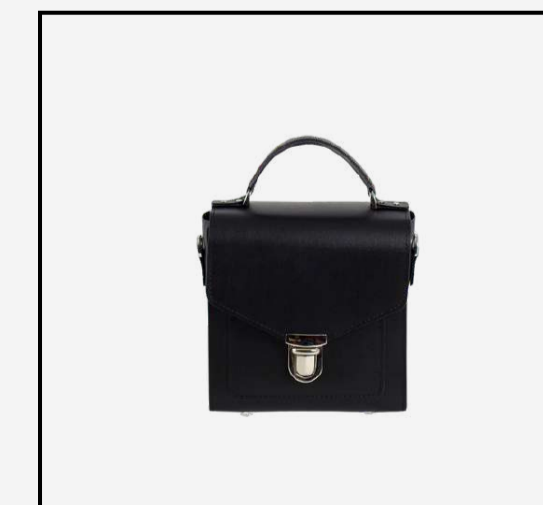

MAT BLACK





POSITIONS | \* The model is 1.70 m tall

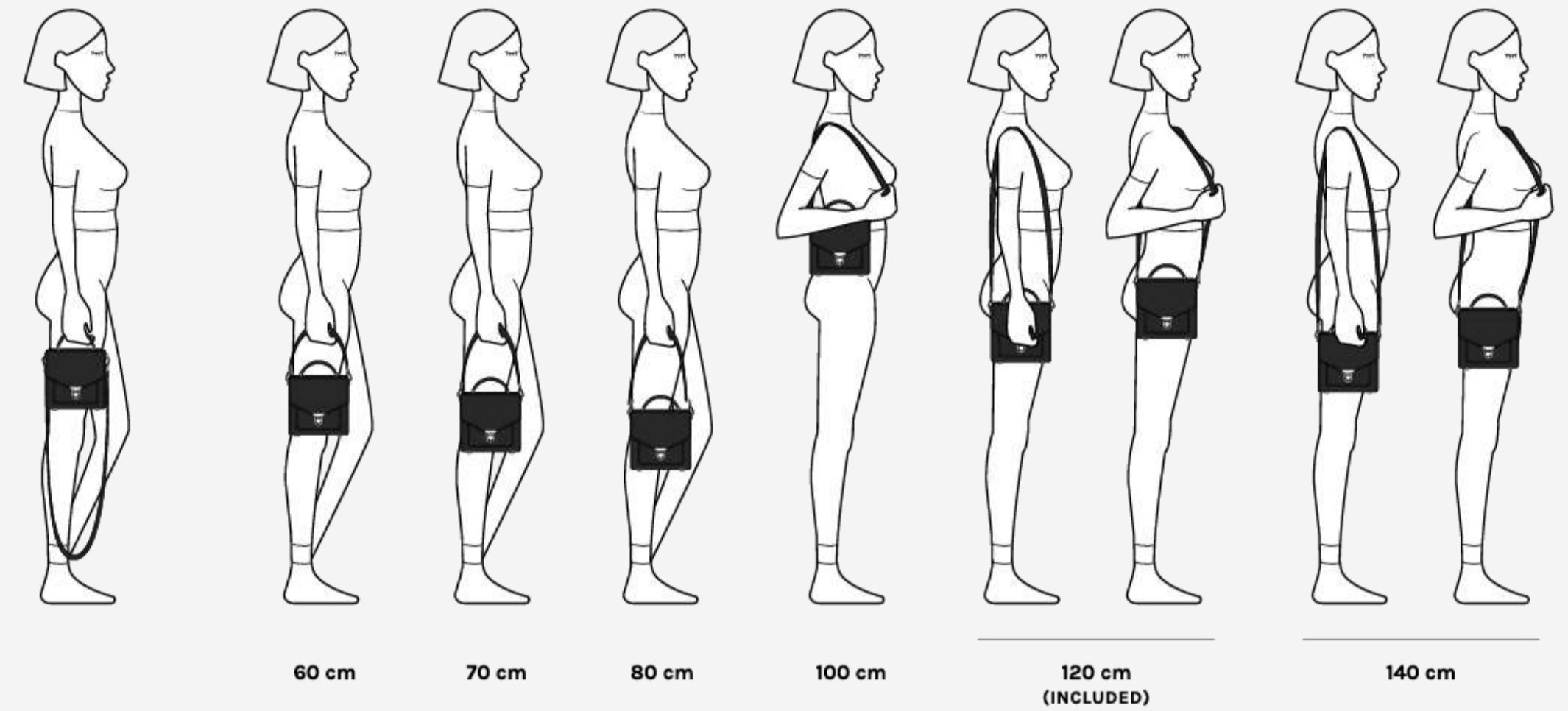

BEST SELLER

## RAMONA (THE SMALL ONE)

SHOP

RETAIL PRICE: 299,95€

\*Sign in to your account to see your wholesale price





POSITIONS | \* The model is 1.70 m tall

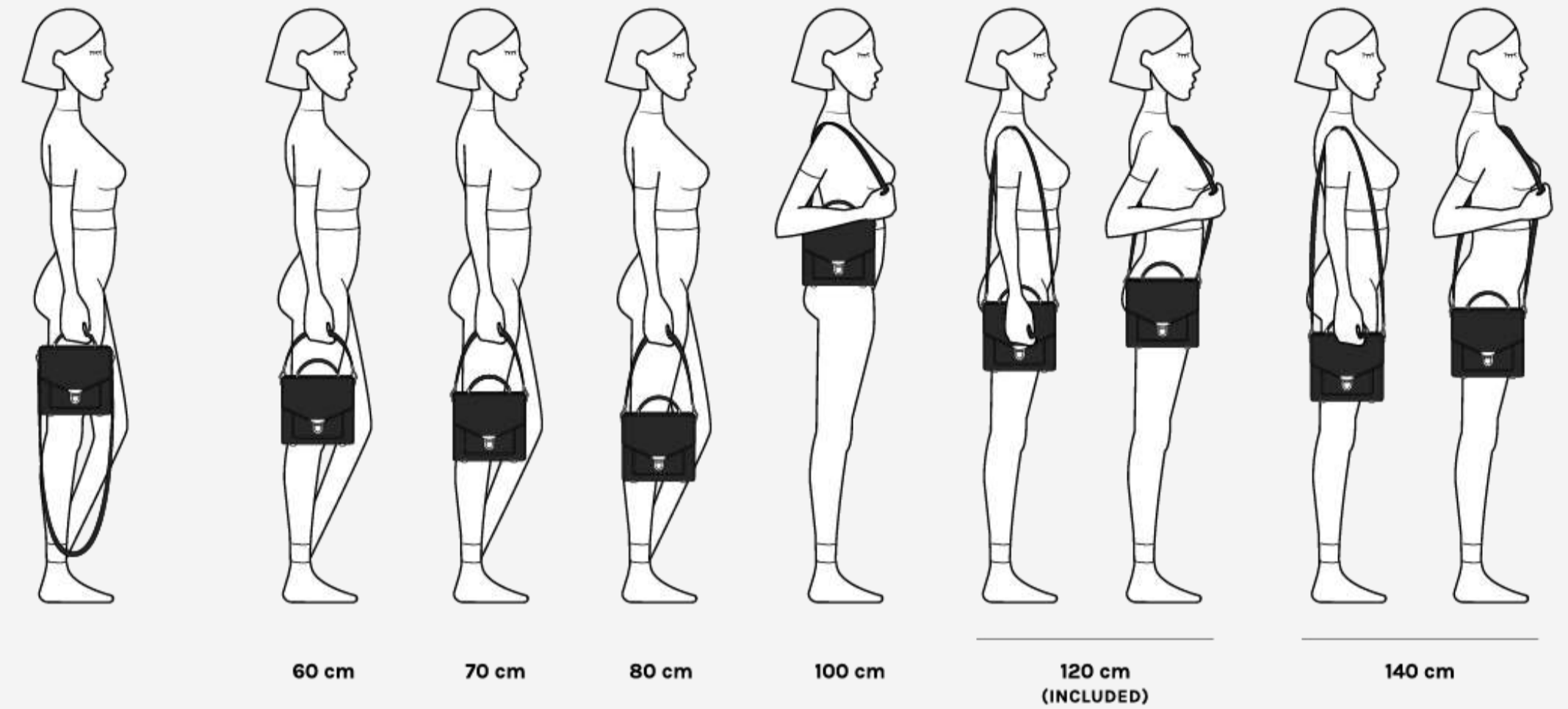

BEST SELLER

## RAMONA (THE BIG ONE)

SHOP

RETAIL PRICE: 329,95€

\*Sign in to your account to see your wholesale price



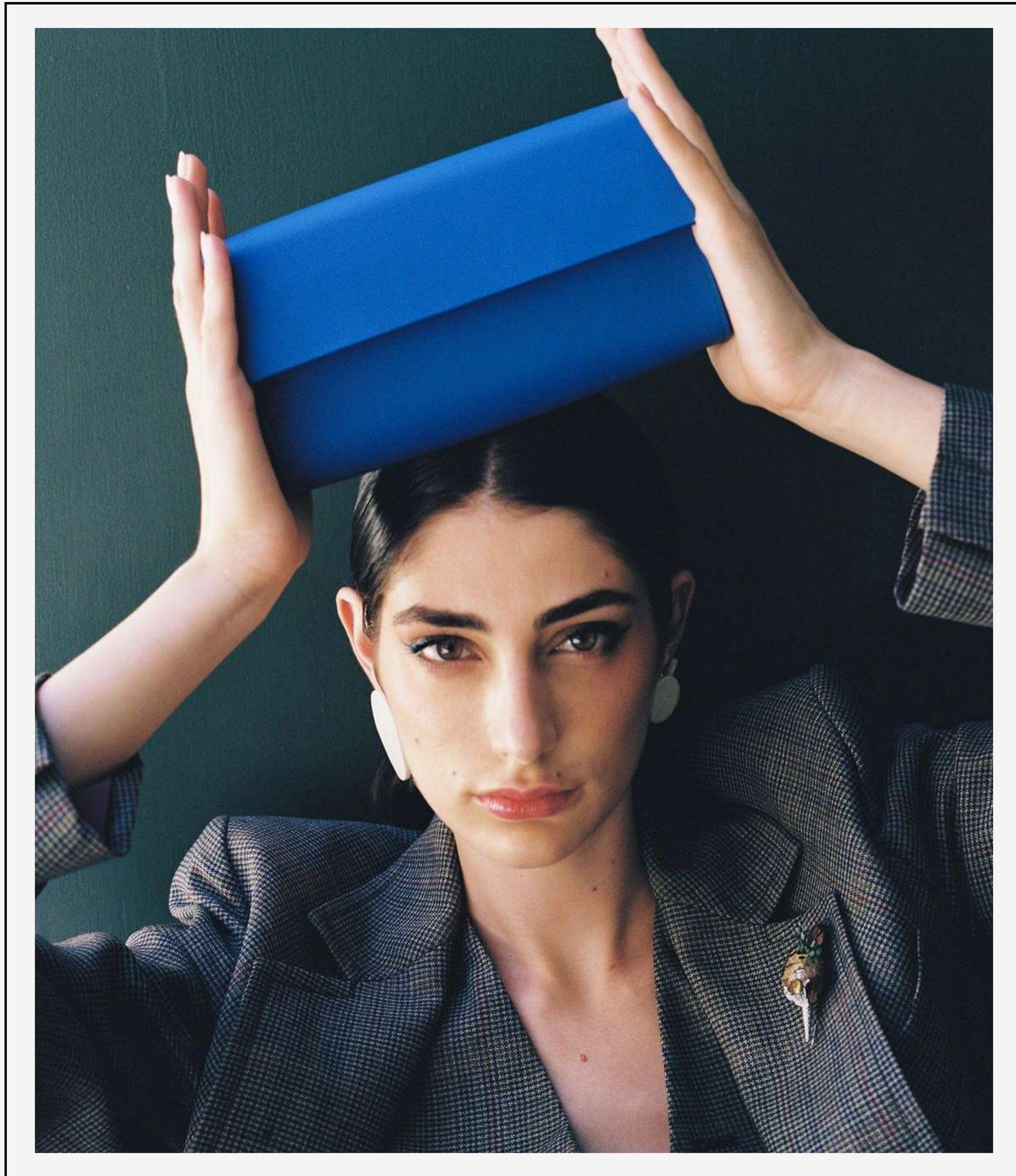

THE BELT BAG / CLUTCH

## LOLA (THE ELDER ONE)

Lola is one of our most iconic models. A multi-use 3 in 1 bag. It can be worn as a clutch, as a belt bag (by adding a belt) or as a shoulder bag.

DISCOVER



THE BELT BAG / CLUTCH

# LOLA (THE ELDER ONE)

- Double magnet flap fastener
- Two inside pockets (one of them is a cardholder)
- Finished and painted edges for a greater protection
- Possibility of adding a 120 cm or 140 cm belt
- Matching accessories

SHOP

EXTRAS

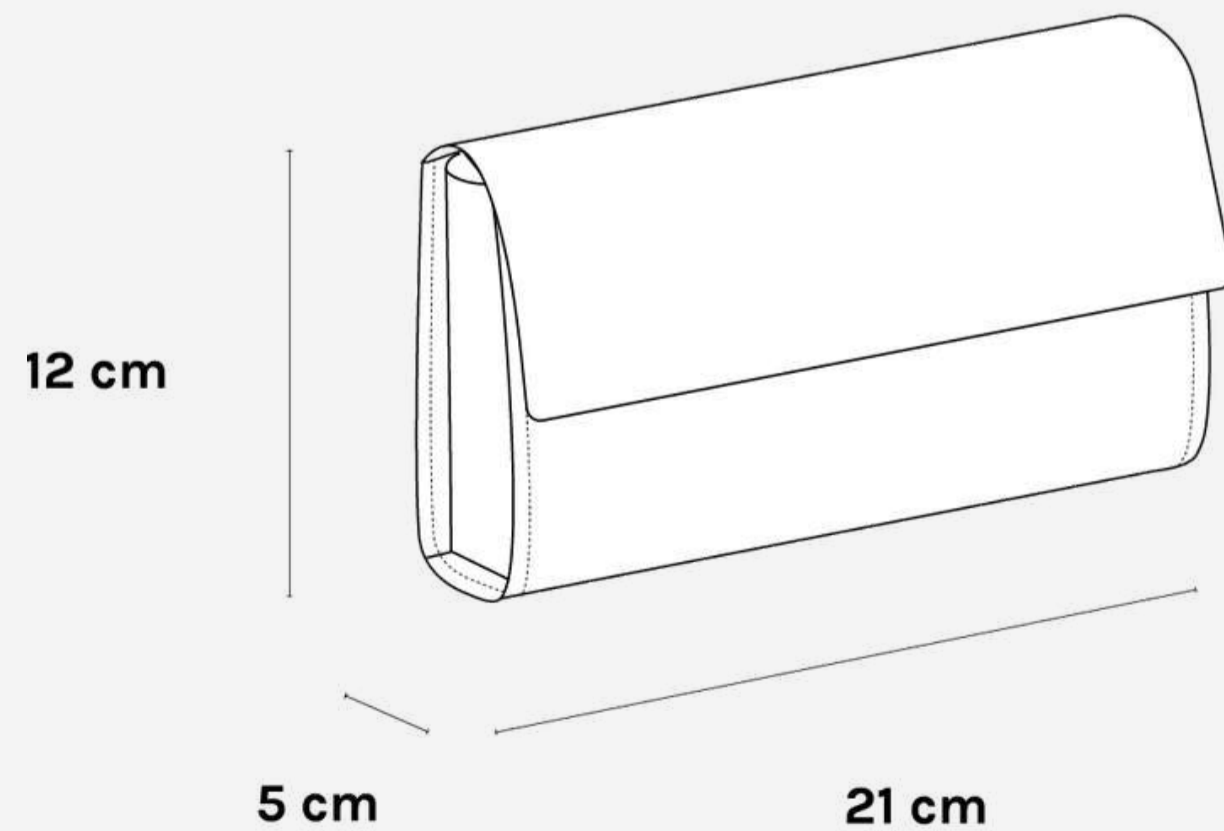

BRICK

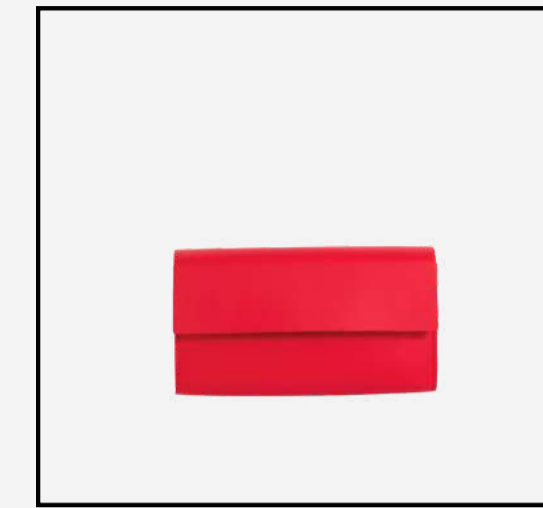

RED



BOOM BLACK



NUDE

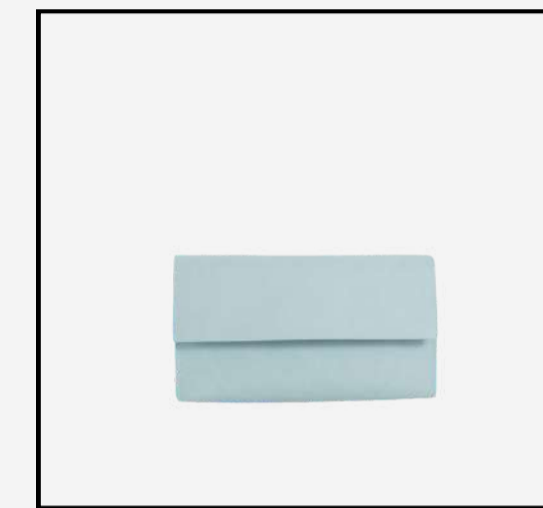

LIGHT-BLUE



WINE



CREAM



TANNED



NAVY

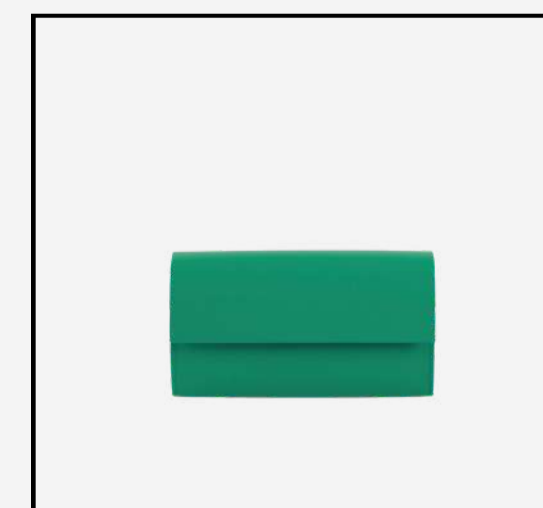

CLOVER GREEN

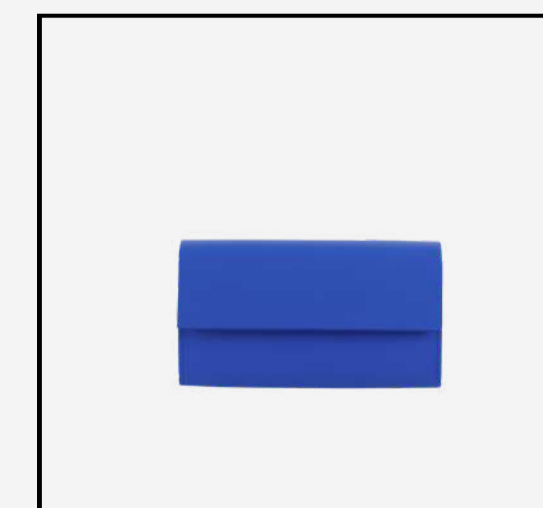

BIENHECHA BLUE



MAT BLACK





POSITIONS | \* The model is 1.70 m tall

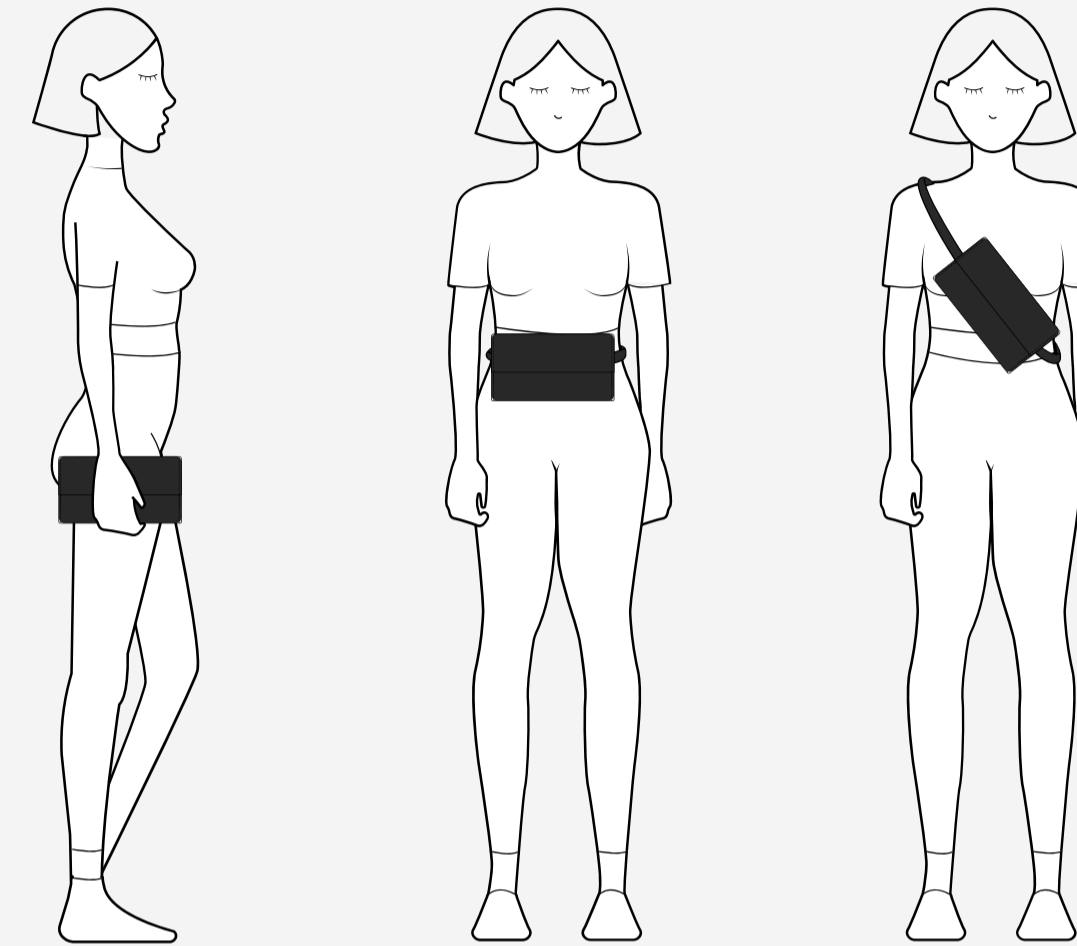

120 cm

140 cm

THE BELT BAG / CLUTCH

## LOLA (THE ELDER ONE)

SHOP

RETAIL PRICE: 159,95€

\*Sign in to your account to see your wholesale price





SPACIOUS & MINIMALIST

## ENCARNITA (THE ELDER ONE)

One of the most minimalist and pure, yet superspacious and comfortable at the same time. Medium sized and very well structured with an impeccable finish.

DISCOVER



SPACIOUS & MINIMALIST

## ENCARNITA (THE ELDER ONE)

- Magnet flap fastener
- One inside pocket
- Finished and painted edges for a greater protection
- One cord-strap included (140 cm)
- Extra cord-straps available: 50 cm, 100 cm, 120 cm or 140 cm
- Matching accessories

SHOP

EXTRAS

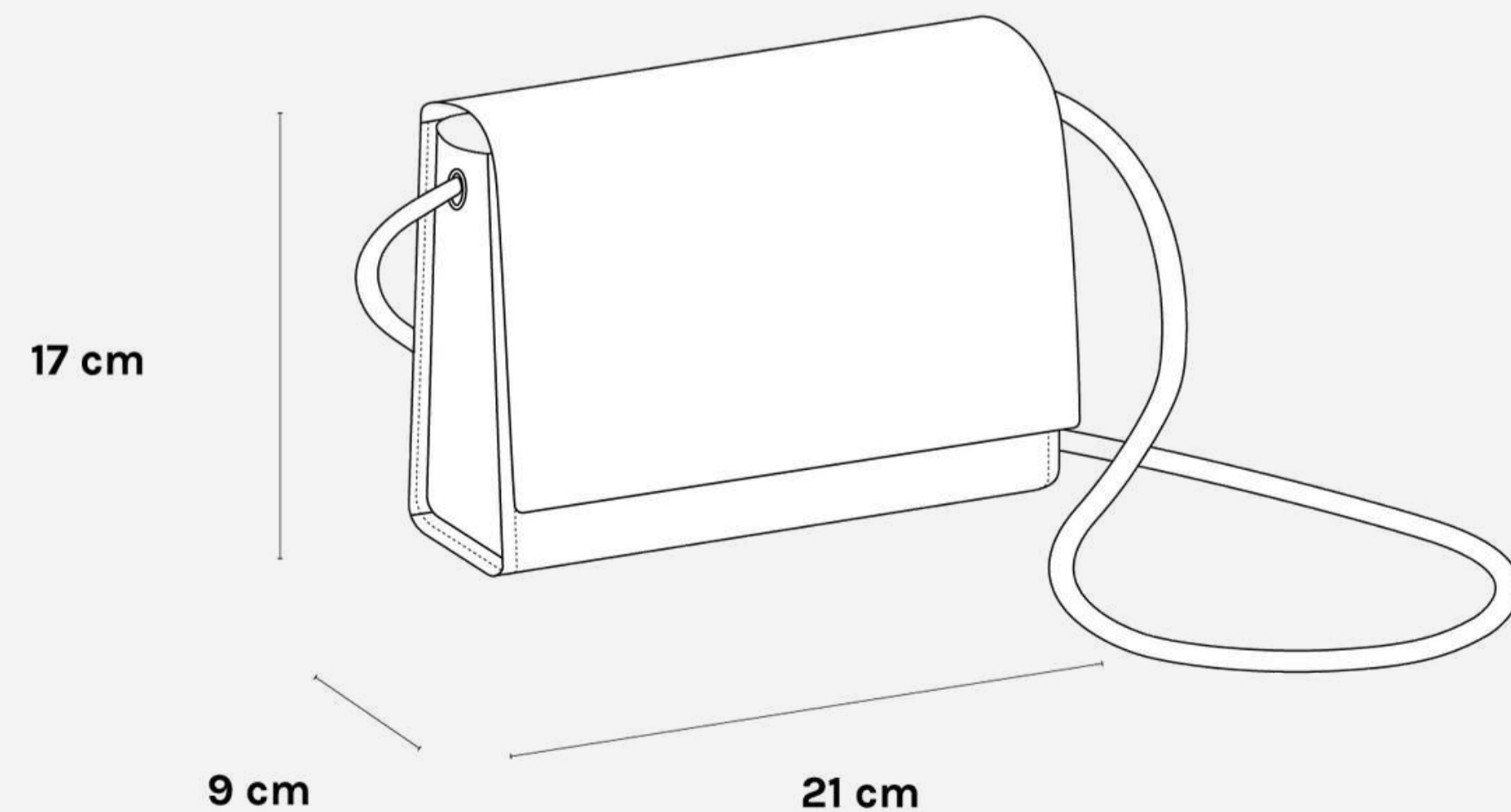

BRICK



RED



BOOM BLACK



NUDE



LIGHT-BLUE



WINE



CREAM



TANNED



NAVY



CLOVER GREEN

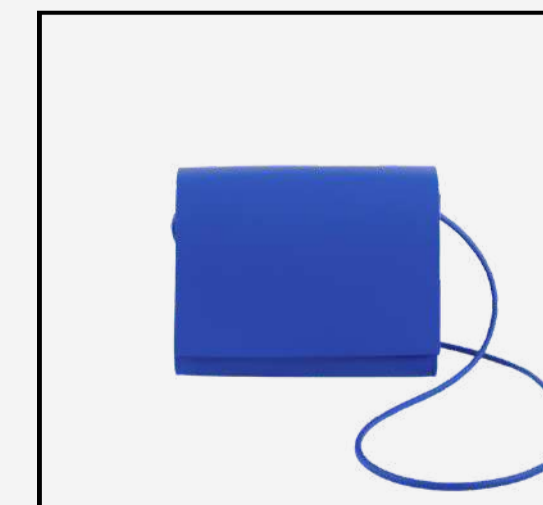

BIENHECHA BLUE



MAT BLACK





POSITIONS | \* The model is 1.70 m tall



50 cm

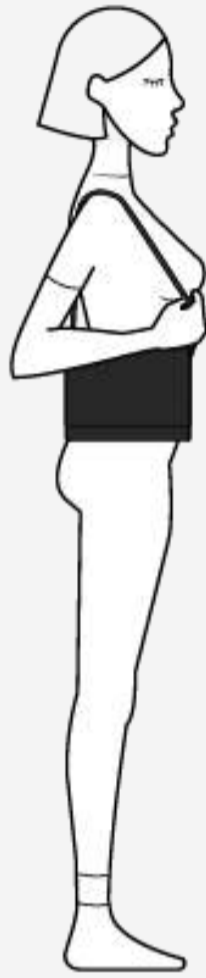

100 cm



120 cm

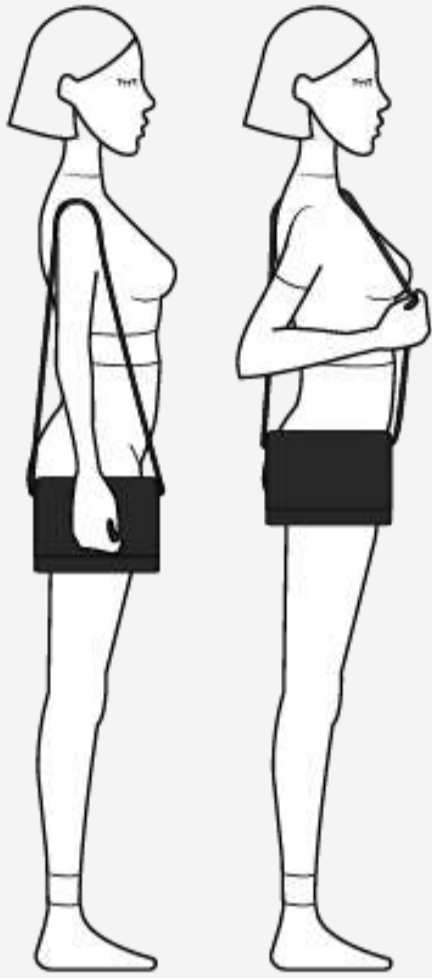

140 cm  
(INCLUDED)

SPACIOUS & MINIMALIST

# ENCARNITA (THE ELDER ONE)

SHOP

RETAIL PRICE: 169,95€

\*Sign in to your account to see your wholesale price



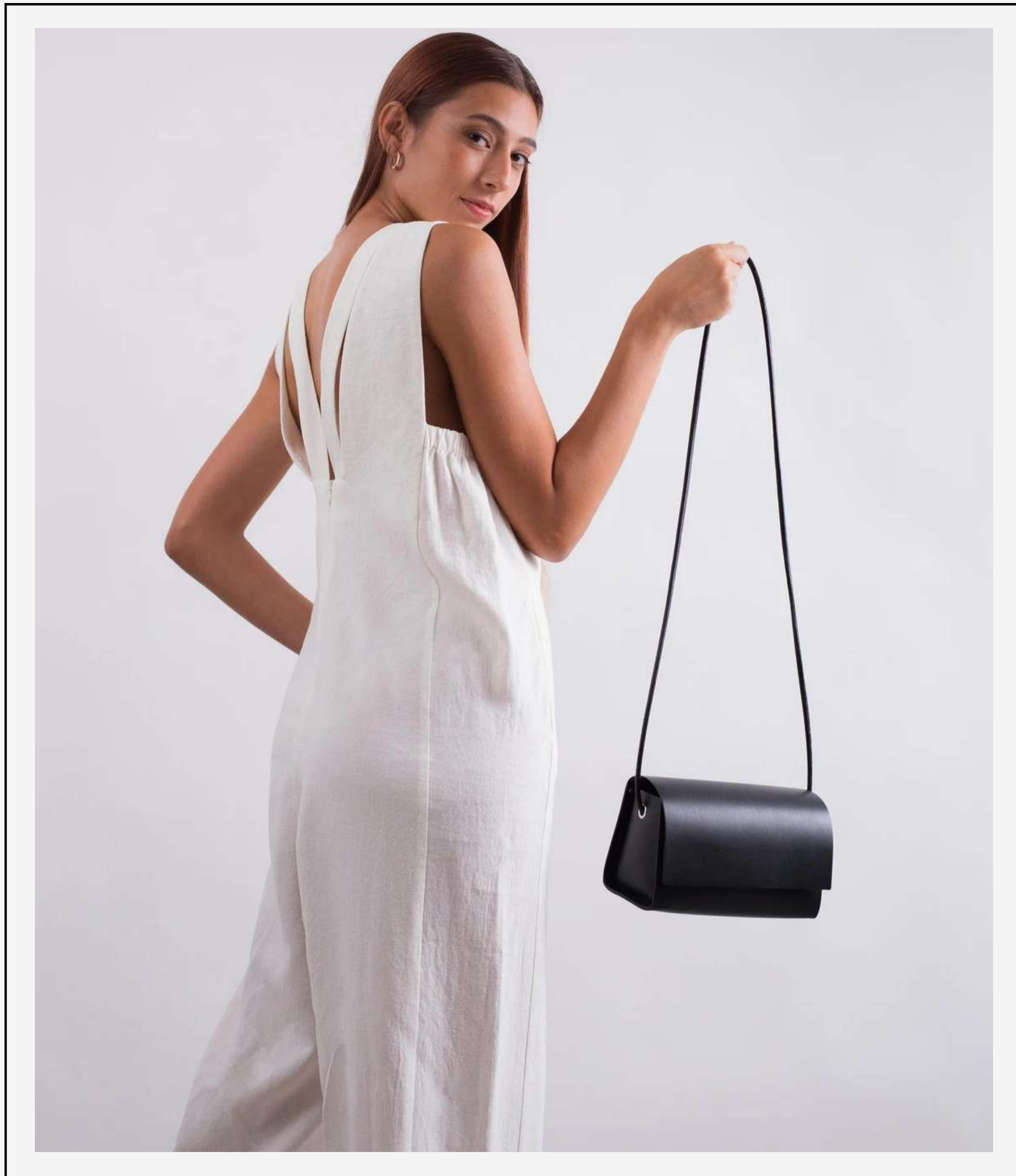

EXTRA SPACIOUS

## AMPARITO (THE ELDER ONE)

A versatile, spacious bag with the ideal size. You will be surprised by Amparito's capacity and the convenience of having everything at hand thanks to its wide size.

DISCOVER



EXTRA SPACIOUS

## AMPARITO (THE ELDER ONE)

- Magnet flap fastener
- One inside pocket
- Finished and painted edges for a greater protection
- One cord-strap included (140 cm)
- Extra cord-straps available: 50 cm, 100 cm, 120 cm or 140 cm
- Matching accessories

SHOP

EXTRAS

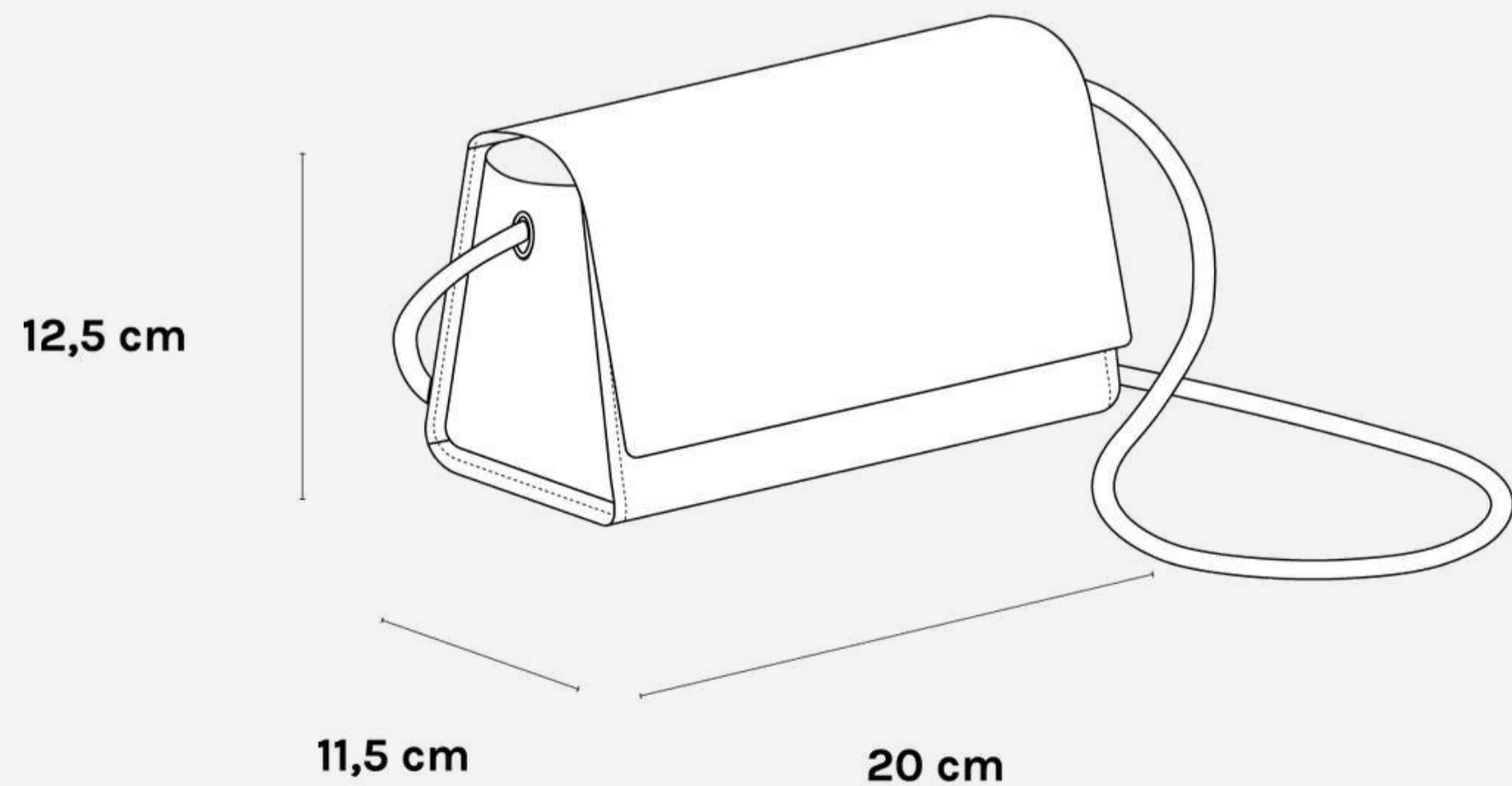

BRICK



RED



BOOM BLACK



NUUDE

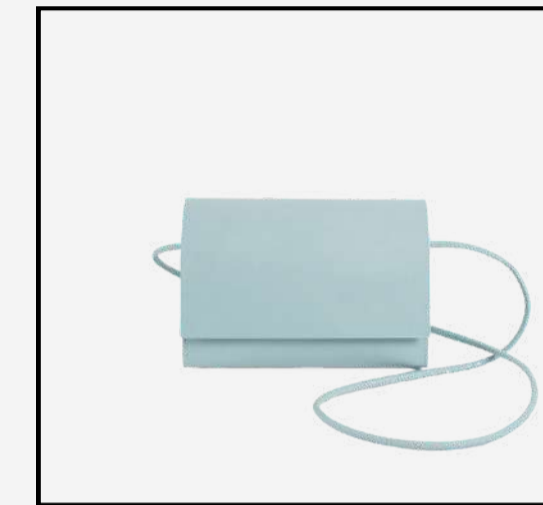

LIGHT-BLUE



WINE



CREAM



TANNED



NAVY

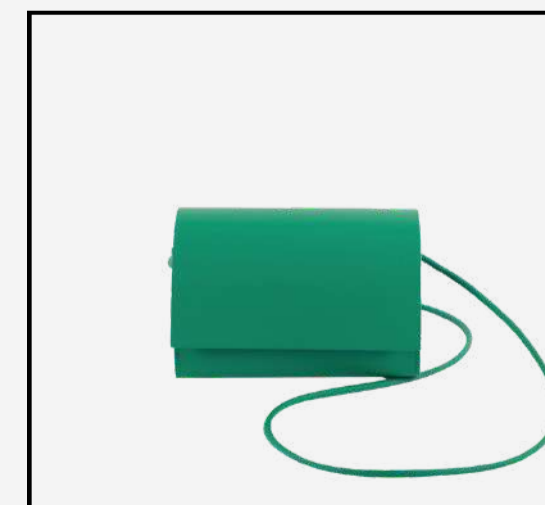

CLOVER GREEN



BIENHECHA BLUE



MAT BLACK





POSITIONS | \* The model is 1.70 m tall



50 cm



100 cm



120 cm

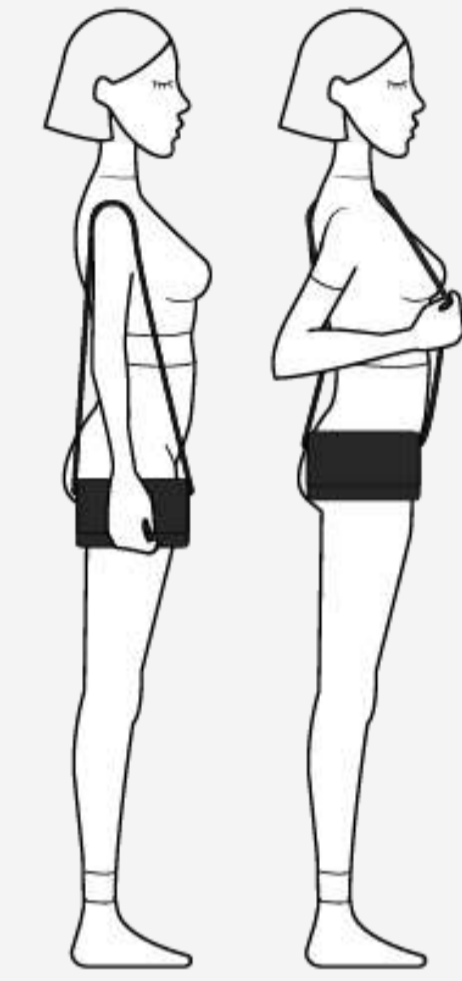

140 cm  
(INCLUDED)

EXTRA SPACIOUS

## AMPARITO (THE ELDER ONE)

SHOP

RETAIL PRICE: 164,95€

\*Sign in to your account to see your wholesale price



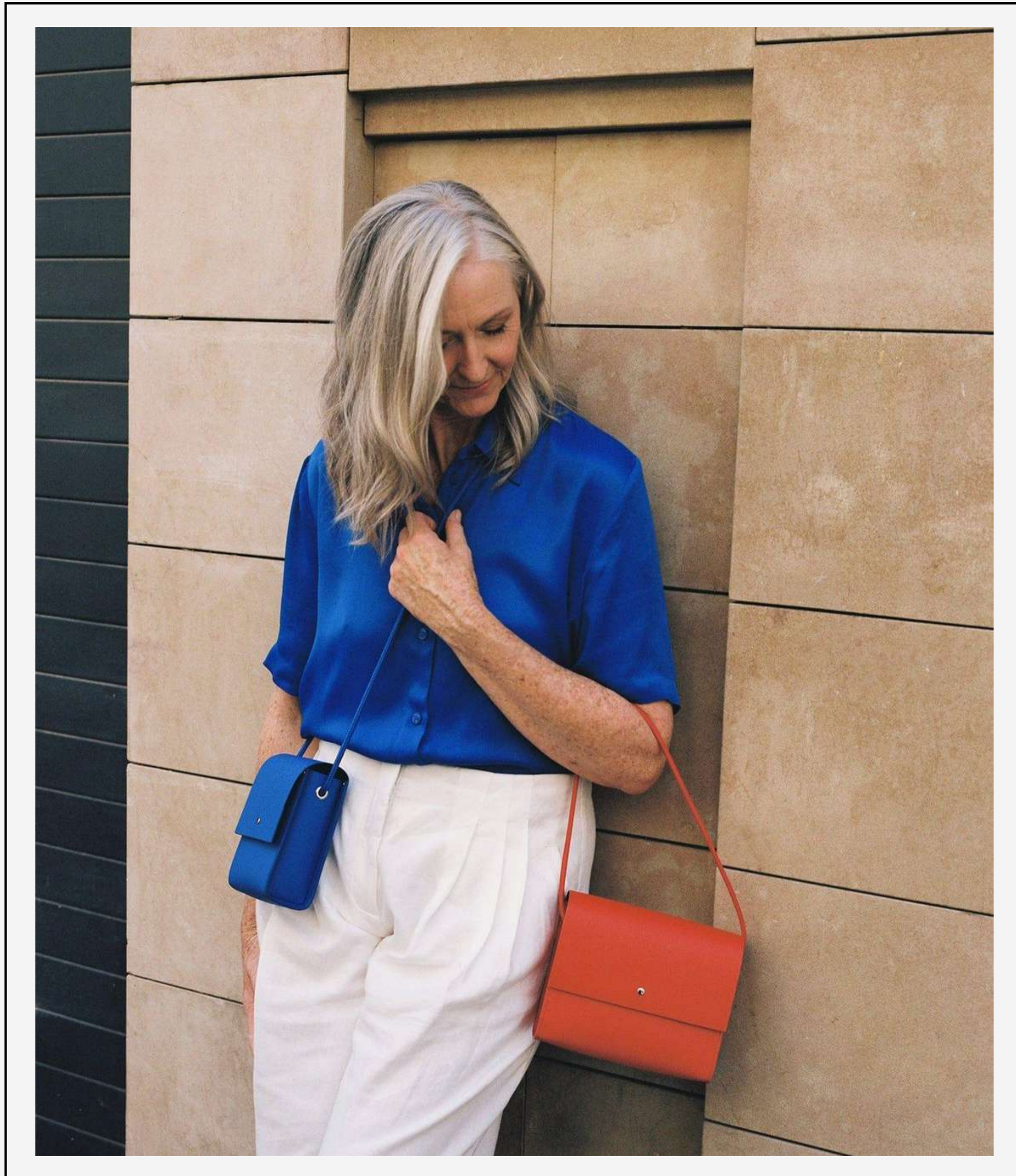

**BASICS**

## **CARMEN**

A super light bag with plenty of space. It is the largest of the family of 3 (Carmelita, Carmela and Carmen). Basic, not so basic.

**DISCOVER**



BASICS

# CARMEN

- Magnet flap fastener
- One inside pocket
- Finished and painted edges for a greater protection
- One cord-strap included (140 cm)
- Extra cord-straps available: 50 cm, 100 cm, 120 cm or 140 cm
- Matching accessories

SHOP

EXTRAS

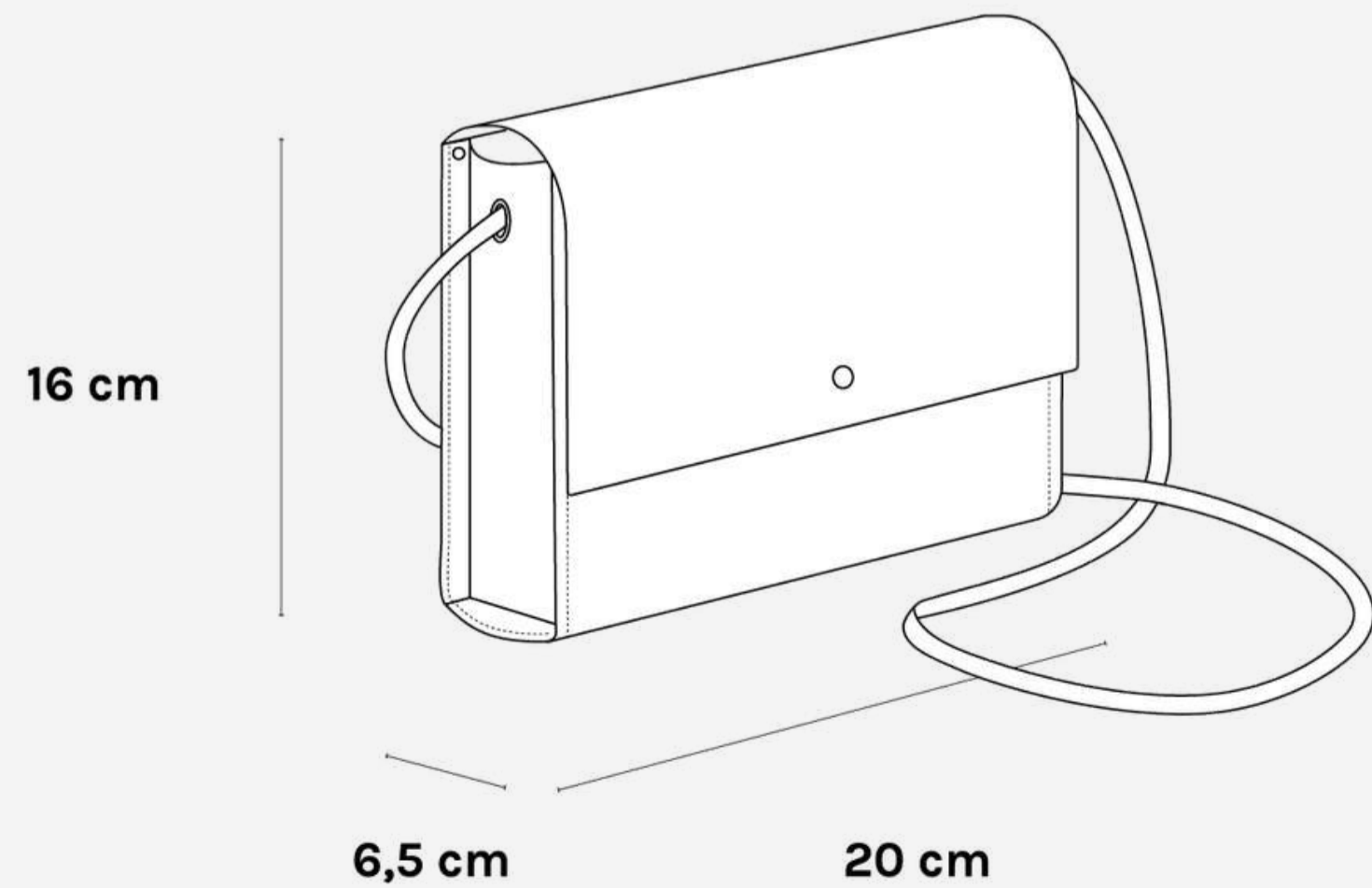

BRICK



RED



BOOM BLACK



NUDE



LIGHT-BLUE



WINE



CREAM



TANNED



NAVY



CLOVER GREEN



BIENHECHA BLUE



MAT BLACK





POSITIONS | \* The model is 1.70 m tall



50 cm



100 cm



120 cm



140 cm  
(INCLUDED)

BASICS

## CARMEN

SHOP

RETAIL PRICE: 159,95€

\*Sign in to your account to see your wholesale price





**BASICS**

## **CARMELA**

It's the middle child of a family of three (Carmelita, Carmela and Carmen). Basic but special, light, with enough space for the essentials and suuuuuper versatile.

**DISCOVER**



BASICS

# CARMELA

- Magnet flap fastener
- One inside pocket
- Finished and painted edges for a greater protection
- One cord-strap included (140 cm)
- Extra cord-straps available: 50 cm, 100 cm, 120 cm or 140 cm
- Matching accessories

SHOP

EXTRAS

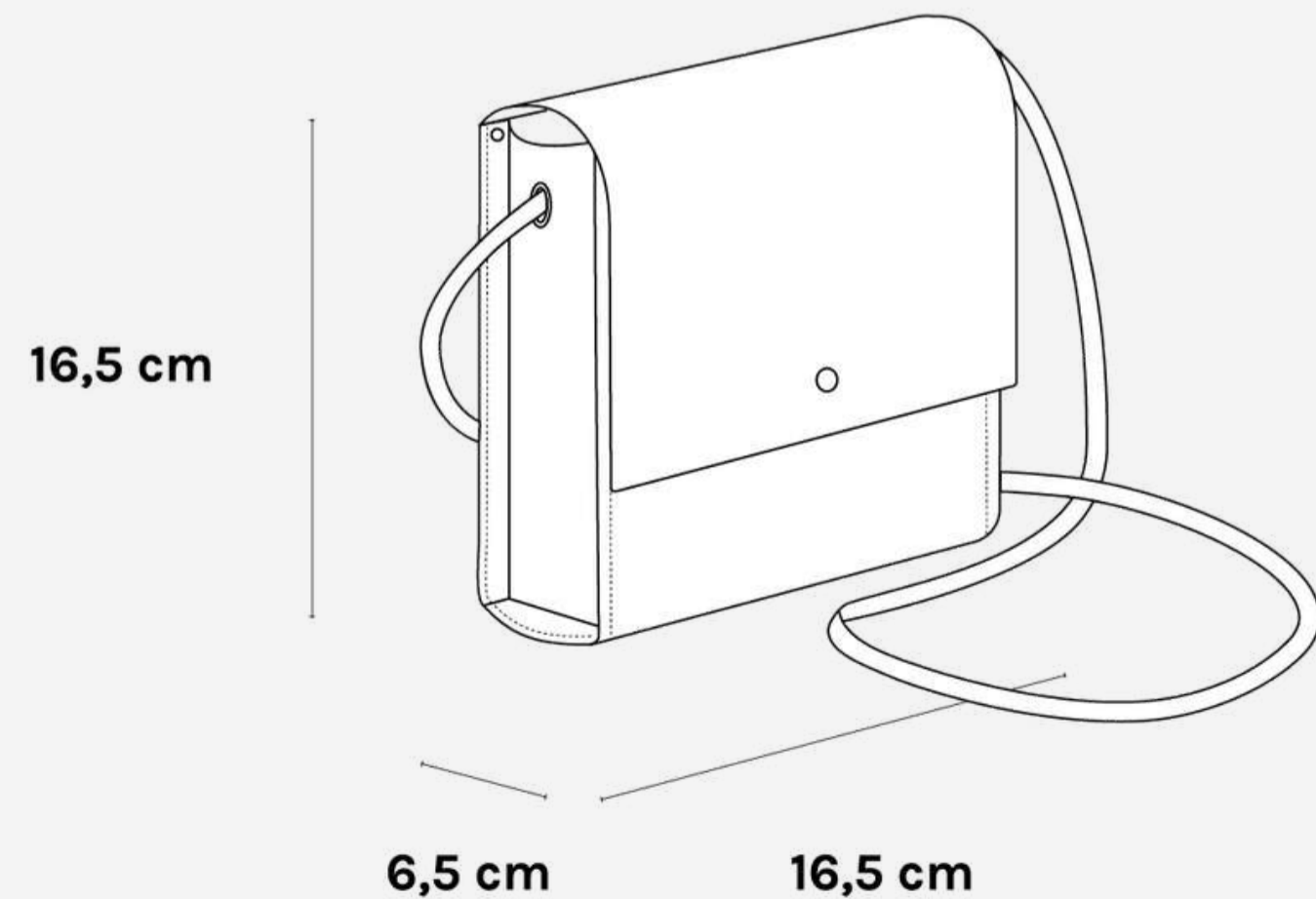

BRICK



RED



BOOM BLACK



NUDE



LIGHT-BLUE



WINE



CREAM



TANNED



NAVY



CLOVER GREEN



BIENHECHA BLUE



MAT BLACK





POSITIONS | \* The model is 1.70 m tall



50 cm



100 cm



120 cm

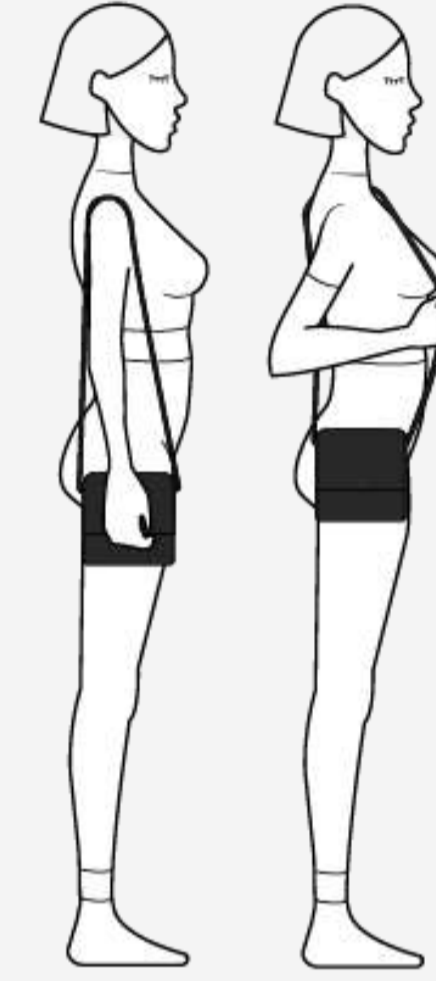

140 cm  
(INCLUDED)

BASICS

## CARMELA

SHOP

RETAIL PRICE: 154,95€

\*Sign in to your account to see your wholesale price



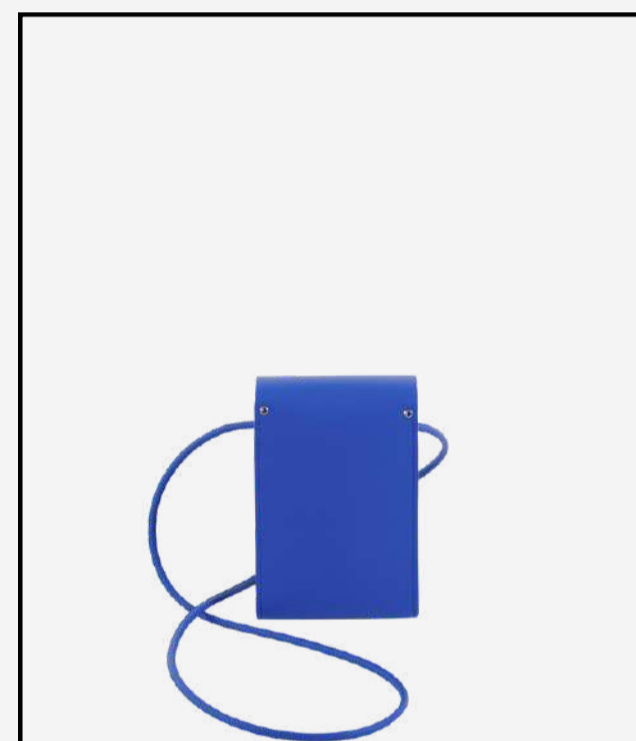
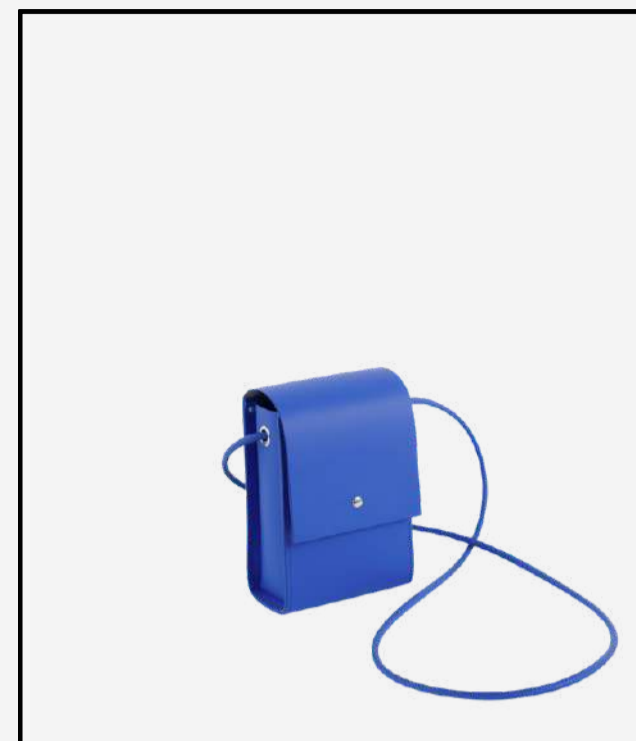

**BASICS**

## **CARMELITA**

The smallest of the family of three (Carmelita, Carmela and Carmen) and full of personality. It weighs nothing at all and is really practical and simple.

**DISCOVER**



## BASICS

# CARMELITA

- Magnet flap fastener
- One inside pocket
- Finished and painted edges for a greater protection
- One cord-strap included (140 cm)
- Extra cord-straps available: 50 cm, 100 cm, 120 cm or 140 cm
- Matching accessories

SHOP

EXTRAS

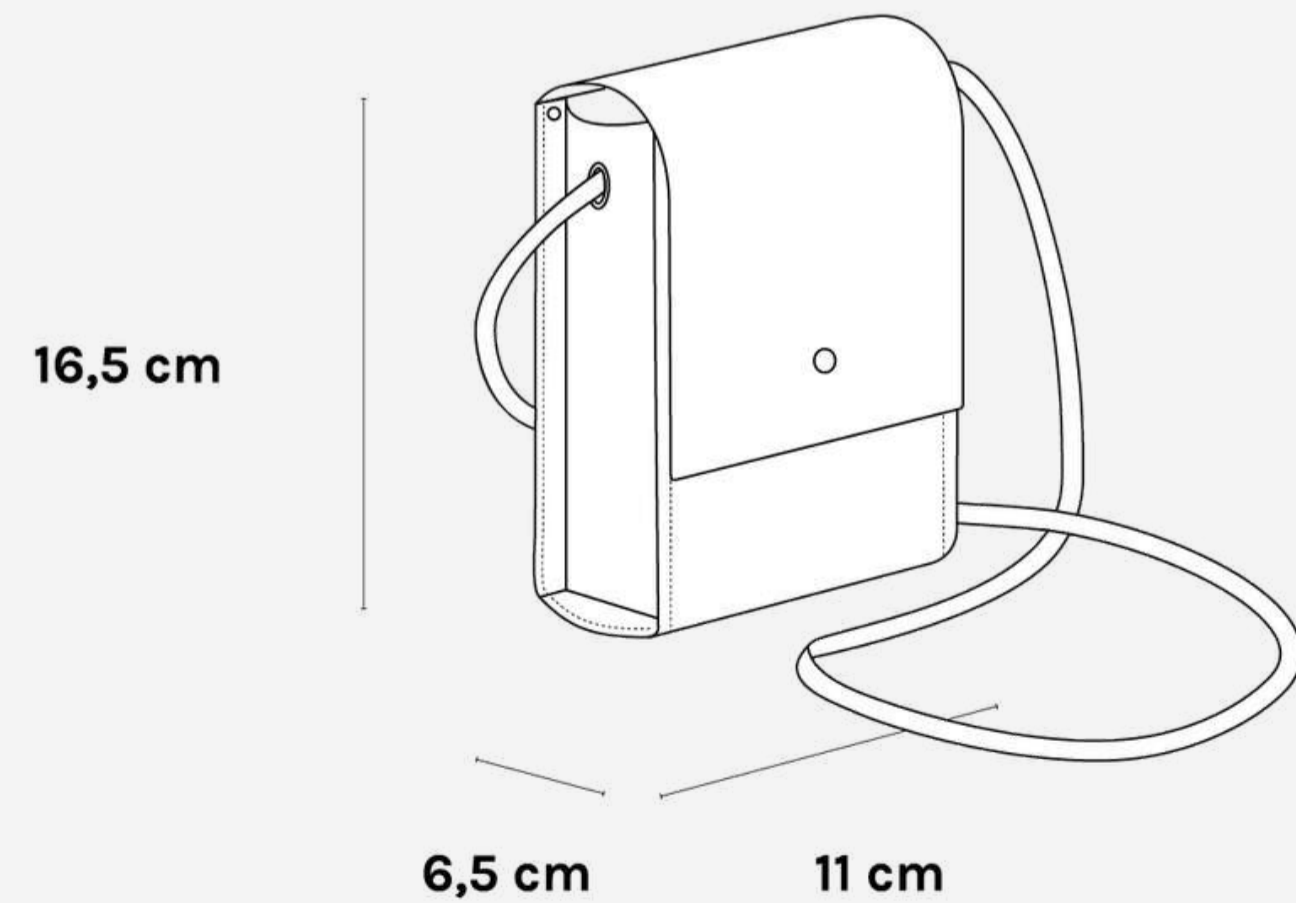

BRICK



RED



BOOM BLACK



NUDE



LIGHT-BLUE



WINE

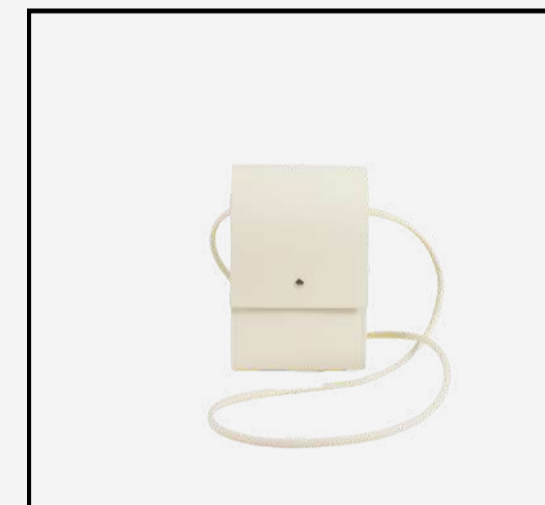

CREAM



TANNED

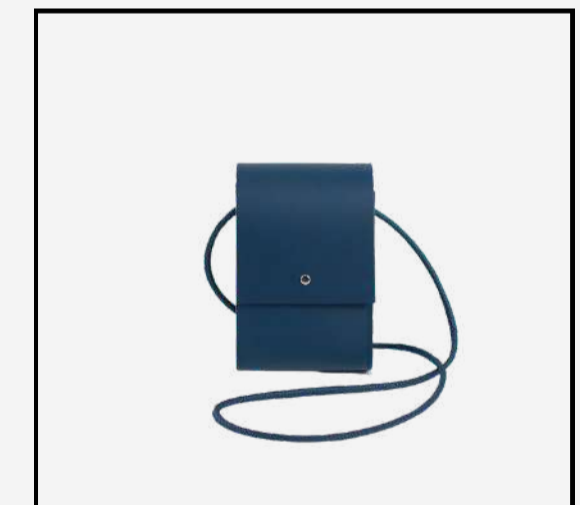

NAVY



CLOVER GREEN



BIENHECHA BLUE

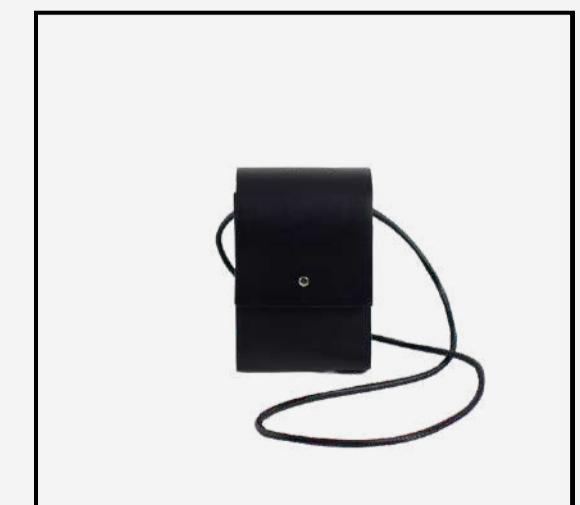

MAT BLACK





POSITIONS | \* The model is 1.70 m tall



50 cm



100 cm



120 cm

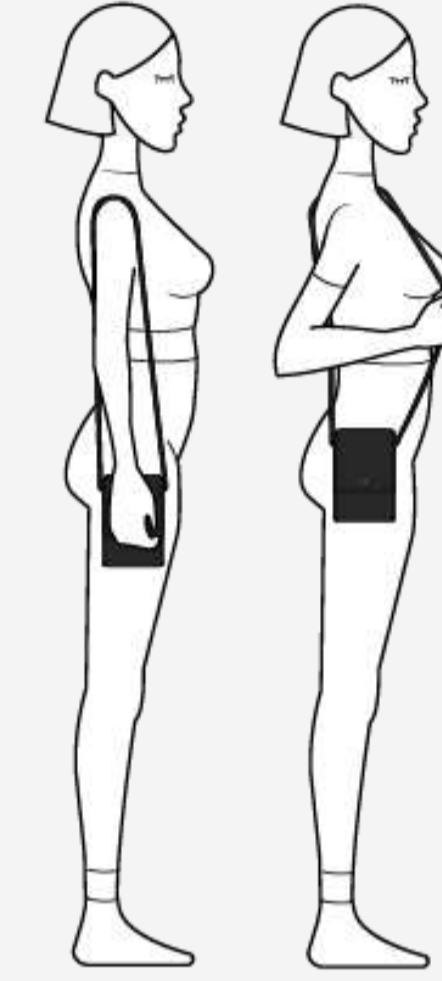

140 cm  
(INCLUDED)

BASICS

## CARMELITA

SHOP

RETAIL PRICE: 149,95€

\*Sign in to your account to see your wholesale price





RECYCLED LEATHER

## ACCESSORIES

Our accessories are the perfect choice to combine with our bags or to use on their own.

DISCOVER



ACCESSORIES

# ROSARITO

- Zip fastener
- Finished and painted edges for a greater protection
- Perfect as a purse or to store cards, tickets, or anything else you want to keep separate inside the bag
- Perfect pack when combined with Rosario

SHOP

RETAIL PRICE: 49,95€

\*Sign in to your account to see your wholesale price

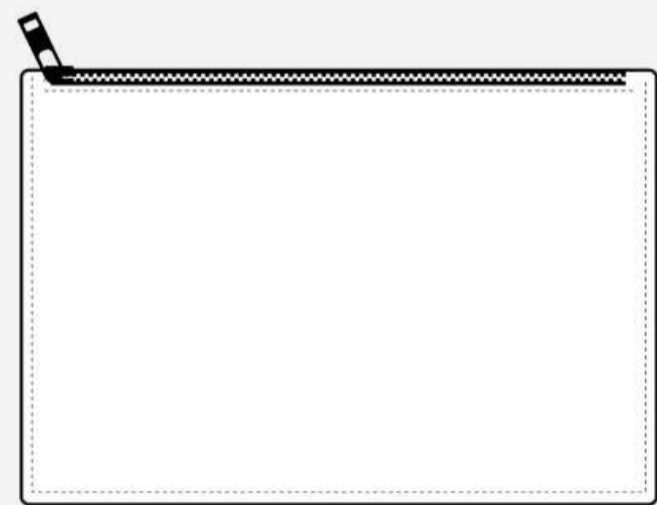

15 cm

10,5 cm



BRICK



RED



BOOM BLACK



NUDE



LIGHT-BLUE



WINE



CREAM



TANNED



NAVY



CLOVER GREEN



BIENHECHA BLUE



MAT BLACK



ACCESSORIES

# ROSARIO

- Zip fastener
- Finished and painted edges for a greater protection
- Perfect as a purse or to store cards, tickets, or anything else you want to keep separate inside the bag
- Perfect pack when combined with Rosarito

SHOP

RETAIL PRICE: 54,95€

\*Sign in to your account to see your wholesale price

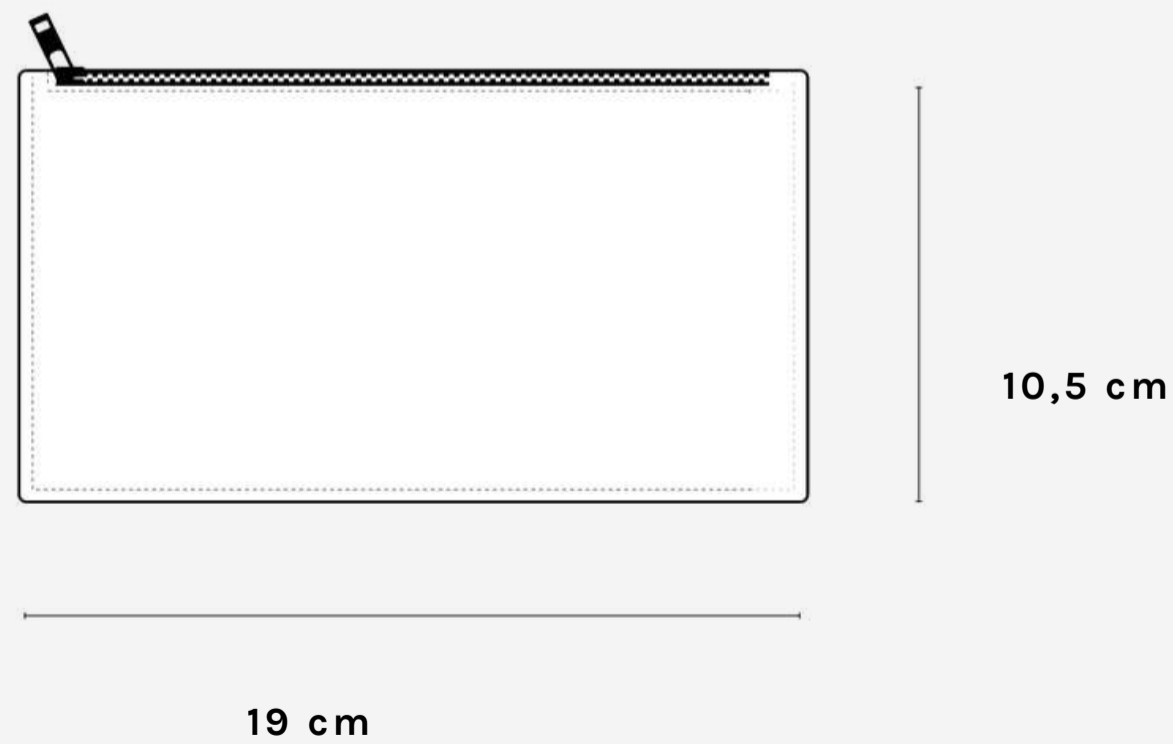

BRICK



RED



BOOM BLACK



NUDE



LIGHT-BLUE



WINE



CREAM



TANNED



NAVY



CLOVER GREEN



BIENHECHA BLUE



MAT BLACK



## ACCESSORIES

# OLIVIA

- Double card holder (maximum 6 cards)
- Finished and painted edges for a greater protection
- Perfect for storing cards, tickets, transport vouchers, etc.

SHOP

RETAIL PRICE: 39,95€

\*Sign in to your account to see your wholesale price

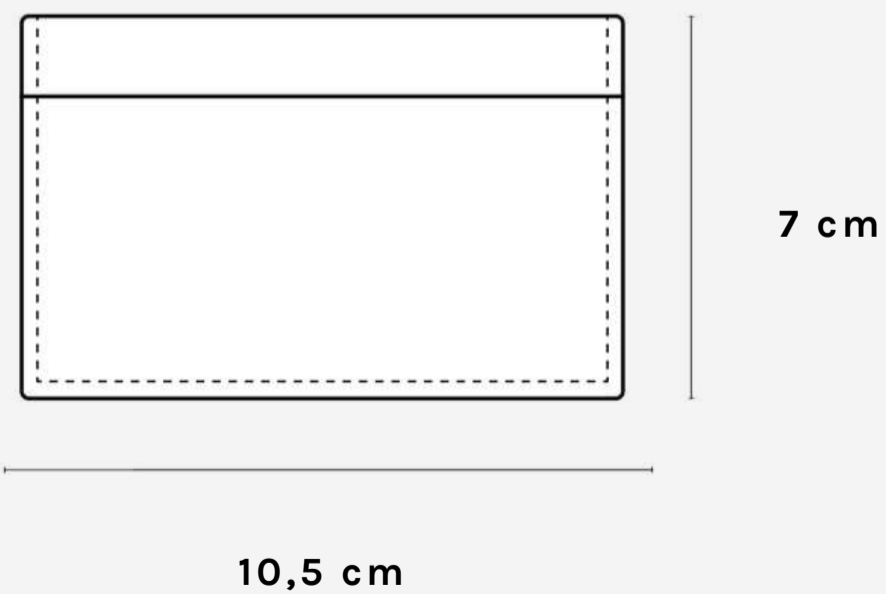

BRICK

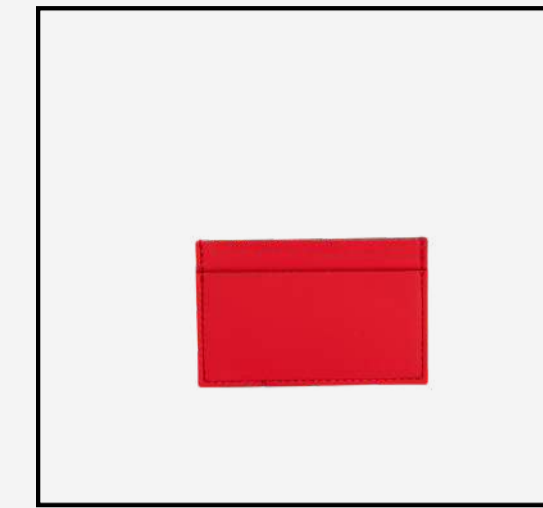

RED

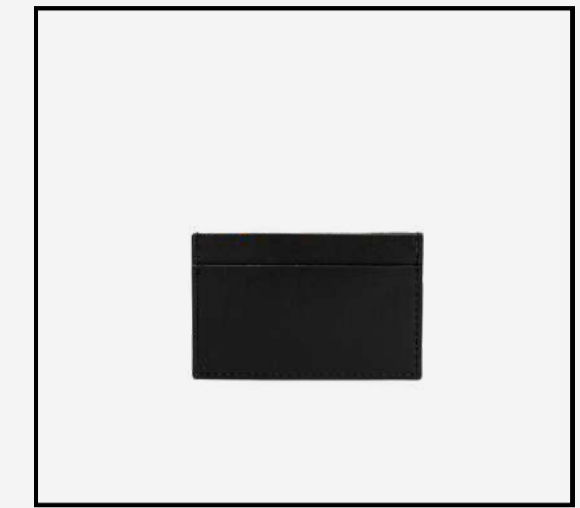

BOOM BLACK



NUDE

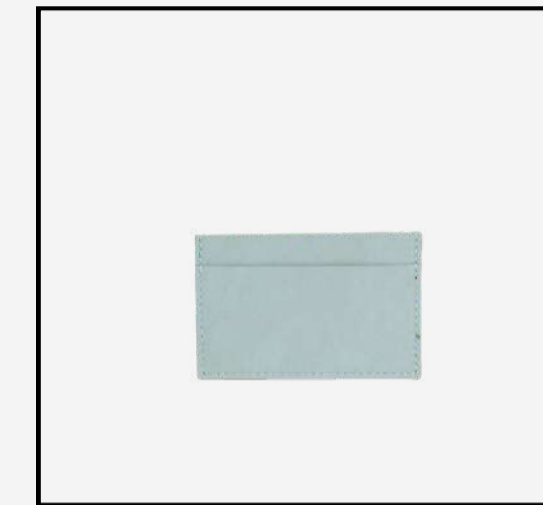

LIGHT-BLUE

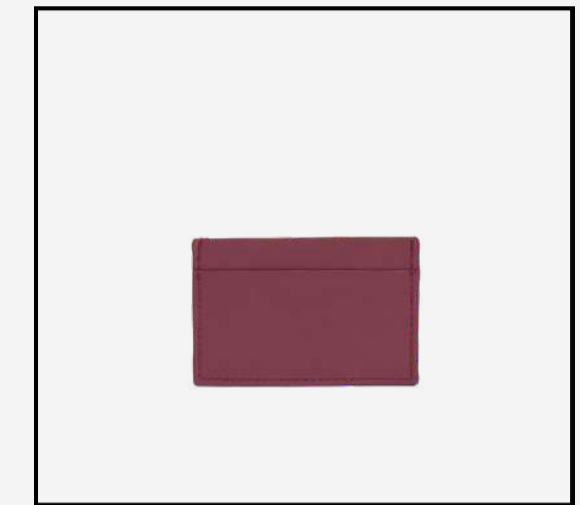

WINE

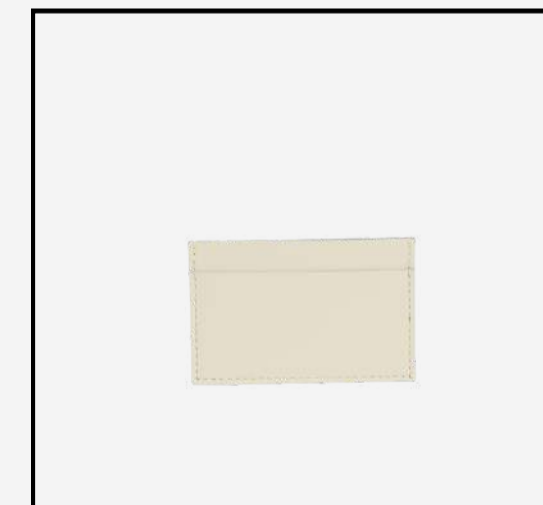

CREAM



TANNED



NAVY

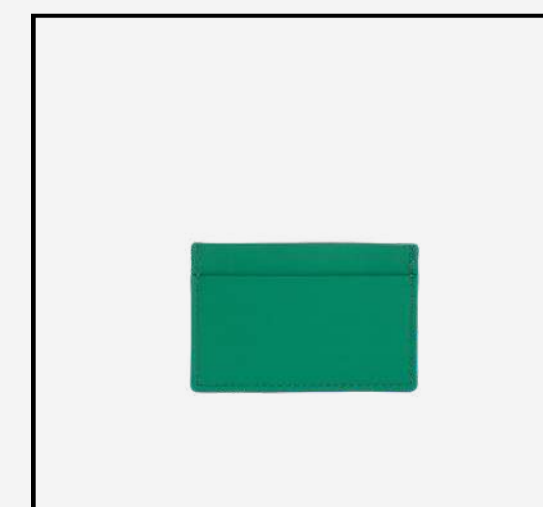

CLOVER GREEN

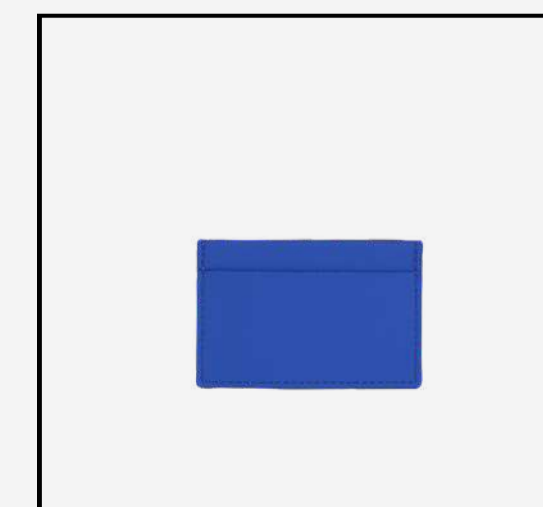

BIENHECHA BLUE



MAT BLACK





RECYCLED LEATHER

## EXTRAS

To spice up our bienhechas. Add straps and cords to interchange, mix colours, and make several bags in one.

DISCOVER



EXTRAS

## SHOULDER BAG PAD

- Small: 2,5 cm x 12,5 cm - For Paca and Paquita
- Big: 4 cm x 18 cm - Bernardita, Bernarda, Carmen, Carmela, Carmelita, Amparito (The Elder One) and Encarnita (The Elder One)

SHOP

RETAIL PRICE: 24,95€

\*Sign in to your account to see your wholesale price

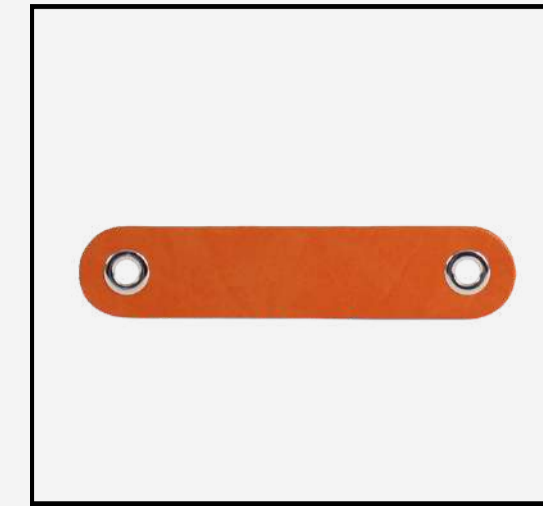

BRICK

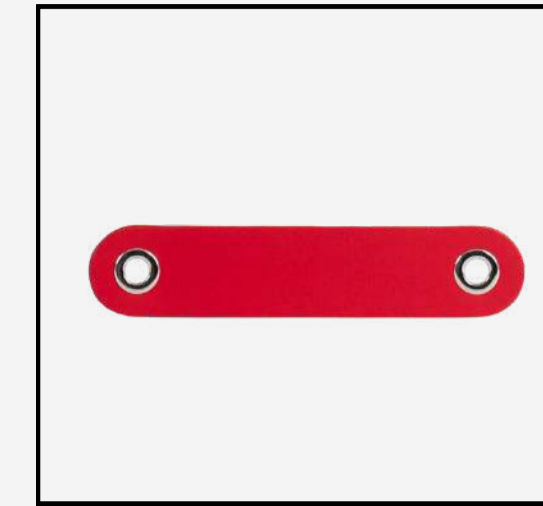

RED

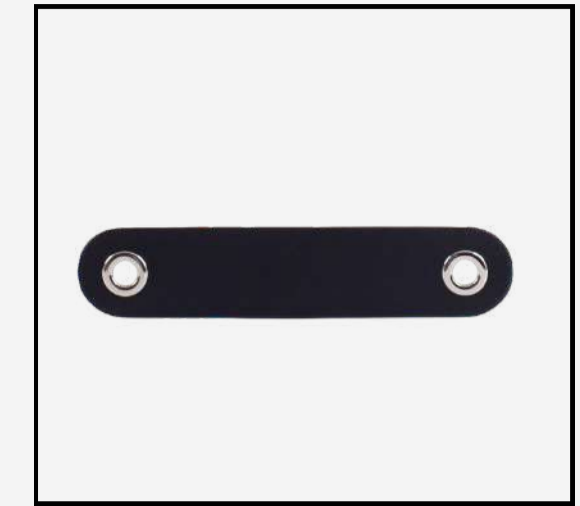

BOOM BLACK

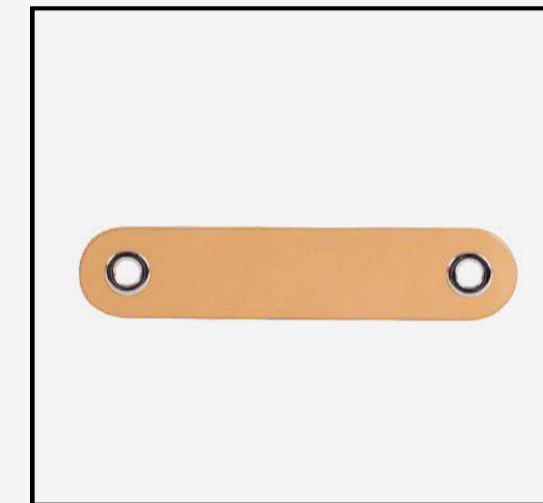

NUDE

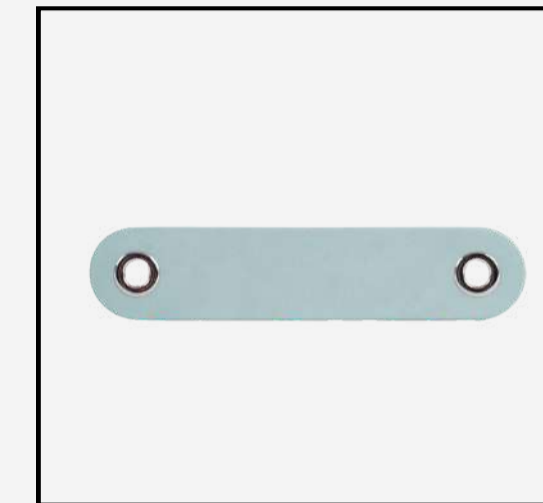

LIGHT-BLUE



WINE



CREAM

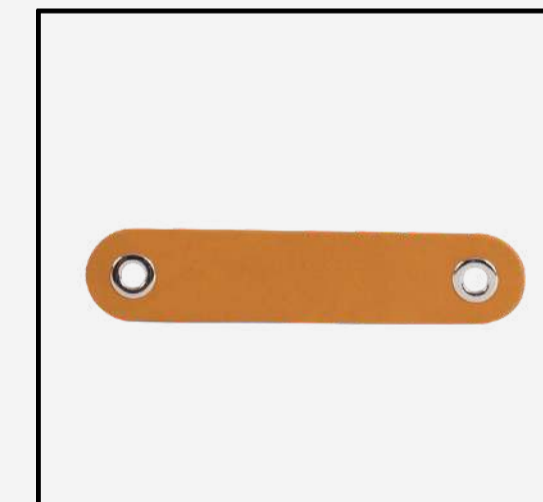

TANNED



NAVY

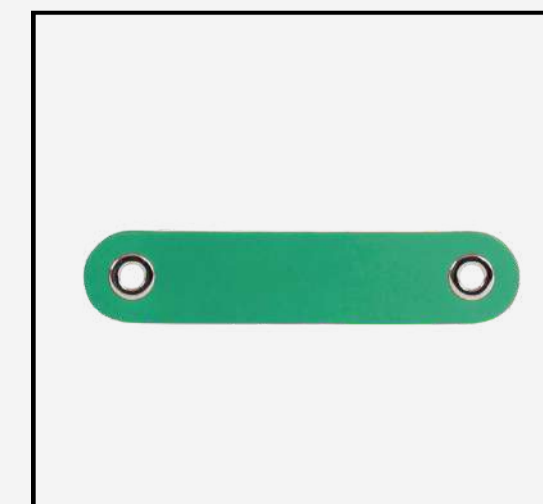

CLOVER GREEN

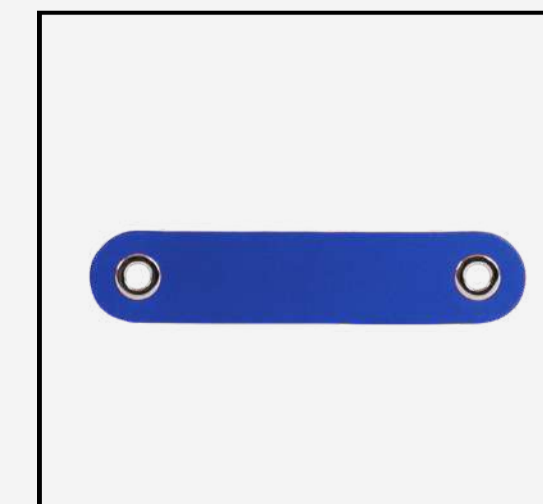

BIENHECHA BLUE



MAT BLACK



EXTRAS

## CORDS

- Adjustable sizes available: 50 cm, 100 cm, 120 cm and 140 cm
- Mini: 0,4 diámetro - For Paca and Paquita
- Maxi: 0,6 diámetro - For Bernardita, Bernarda, Carmen, Carmela, Carmelita, Amparito (The Elder One) and Encarnita (The Elder One)

SHOP

RETAIL PRICE: 15,95€

\*Sign in to your account to see your wholesale price



BRICK



RED



BOOM BLACK



NUDE

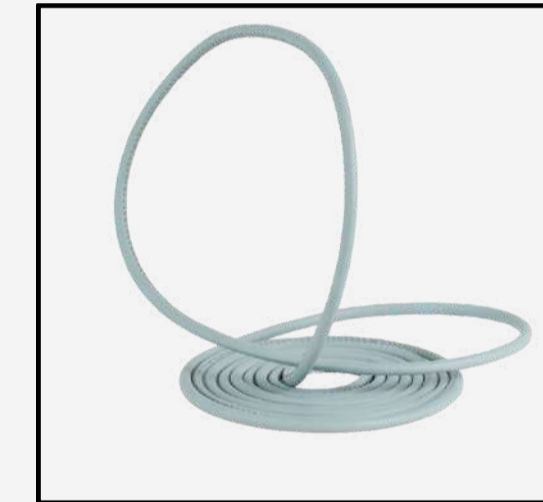

LIGHT-BLUE



WINE



CREAM



TANNED



NAVY



CLOVER GREEN



BIENHECHA BLUE



MAT BLACK



EXTRAS

## BELTS

- Available sizes: 120 cm and 140 cm
- Finished and painted edges
- Adjustable
- Compatible with LOLA (THE ELDER ONE)

SHOP

RETAIL PRICE: 59,95€

\*Sign in to your account to see your wholesale price



BRICK



RED



BOOM BLACK



NUPE



LIGHT-BLUE



WINE



CREAM



TANNED



NAVY



CLOVER GREEN



BIENHECHA BLUE



MAT BLACK



EXTRAS

## STRAPS

- Available sizes: 60 cm, 70 cm, 80 cm, 100 cm, 120 cm y 140 cm
- Finished and painted edges
- Adjustable
- Compatible with Sofía Madre, Sofía Hija, Josefa, Pepa

SHOP

RETAIL PRICE: 34,95€

\*Sign in to your account to see your wholesale price



BRICK



RED



BOOM BLACK

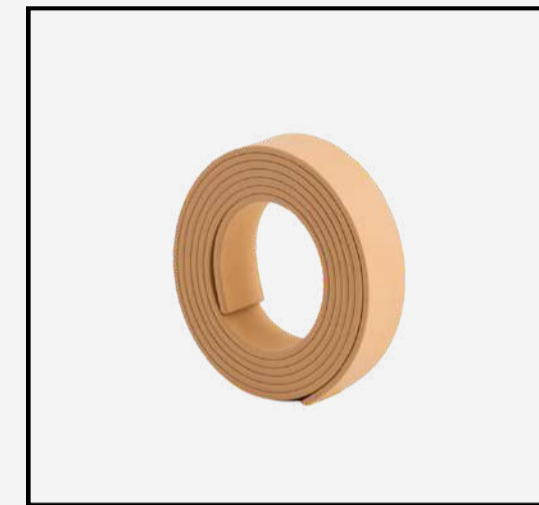

NUPE

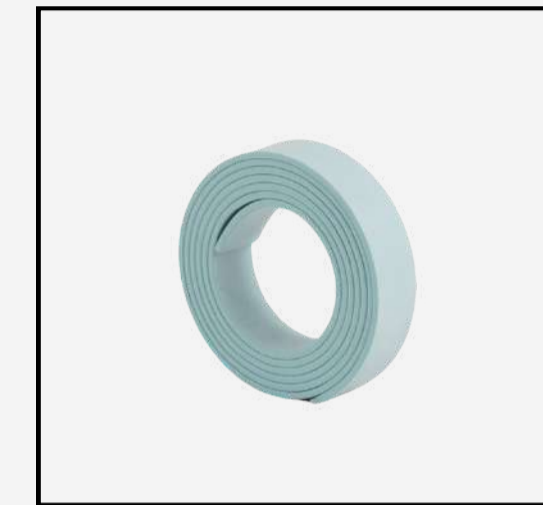

LIGHT-BLUE



WINE



CREAM



TANNED



NAVY



CLOVER GREEN

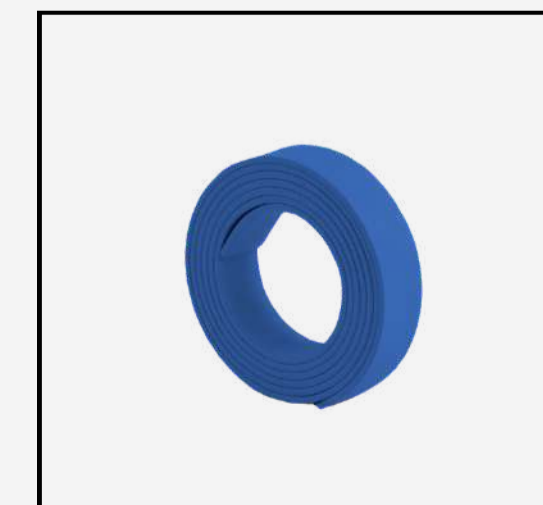

BIENHECHA BLUE



MAT BLACK



EXTRAS

## CARABINER STRAP

- Available sizes: 60 cm, 70 cm, 100 cm, 120 cm and 140 cm
- Finished and painted edges
- Adjustable
- Compatible with Sofía Madre, Sofía Hija, Josefa, Pepa

SHOP

RETAIL PRICE: 39,95€

\*Sign in to your account to see your wholesale price



BRICK



RED



BOOM BLACK

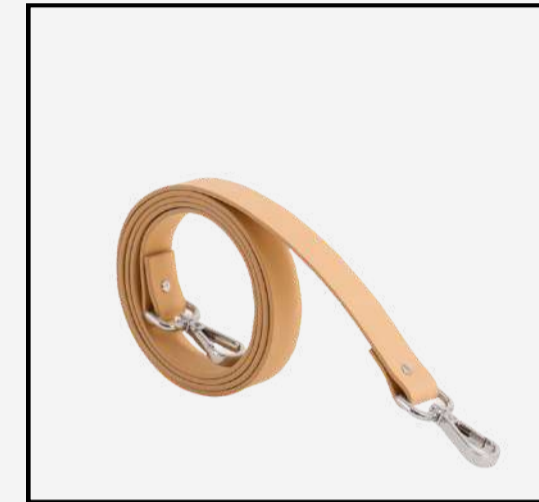

NUDE



LIGHT-BLUE



WINE



CREAM

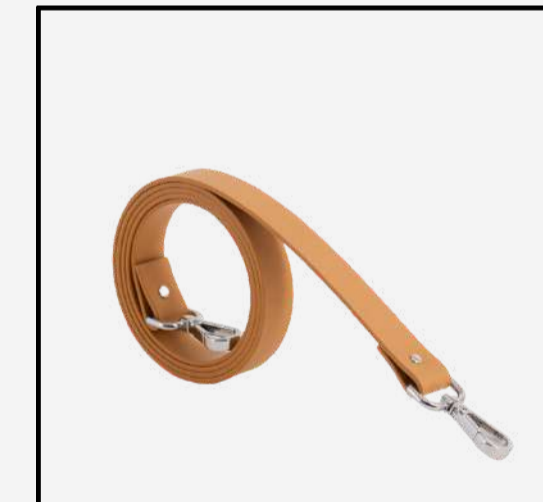

TANNED



NAVY



CLOVER GREEN



BIENHECHA BLUE

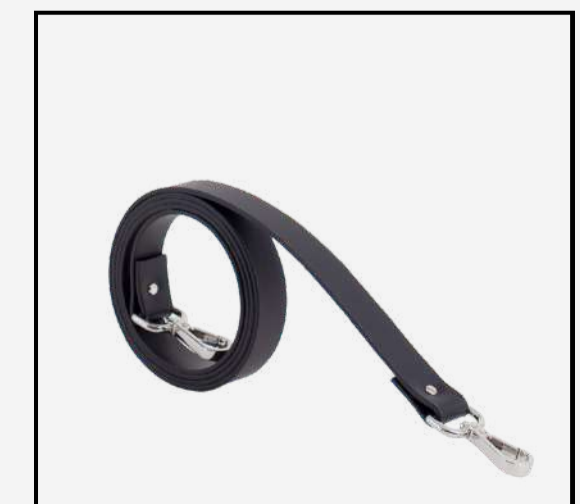

MAT BLACK





RECYCLED LEATHER

## EARRINGS

Our earrings are made using all the recycled leather scraps and putting kilos and kilos of love into each piece.

[DISCOVER](#)



## EARRINGS

# CLARA

- Very light
- Antiallergic (the trimming is made of surgical steel)
- Handcrafted with small scraps of leather to reduce our waste and make the most of everything we have in the workshop
- Hand-painted and polished edges, one by one
- Sizes: 1'5 cm (in its wider part) x 2'5 cm (more or less, as they're handmade :))
- Order them in your colour palette

SHOP

RETAIL PRICE: 39,95€

\*Sign in to your account to see your wholesale price

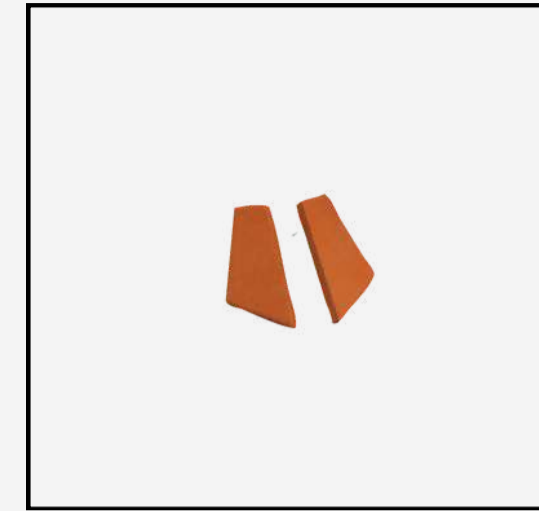

BRICK

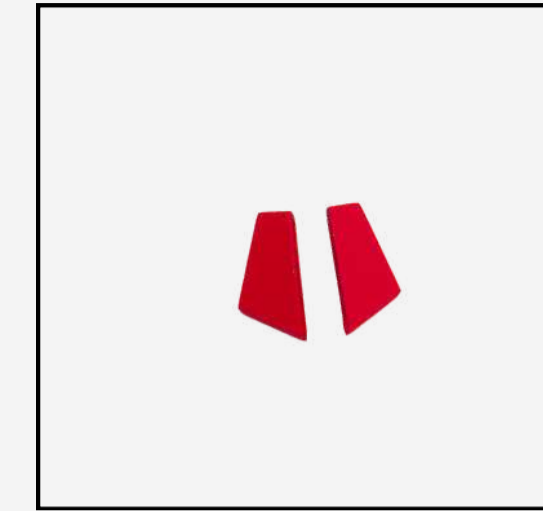

RED



BOOM BLACK

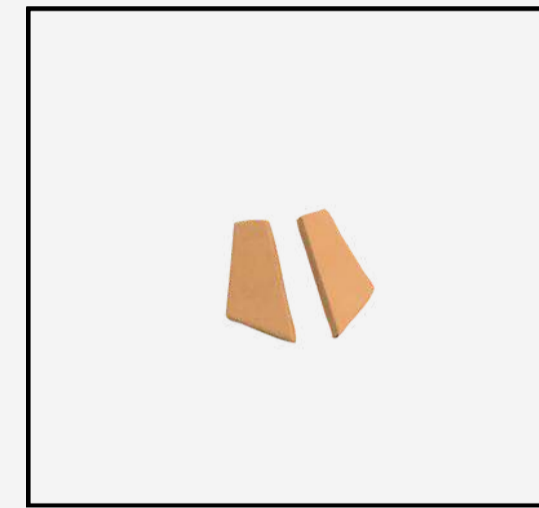

NUDE

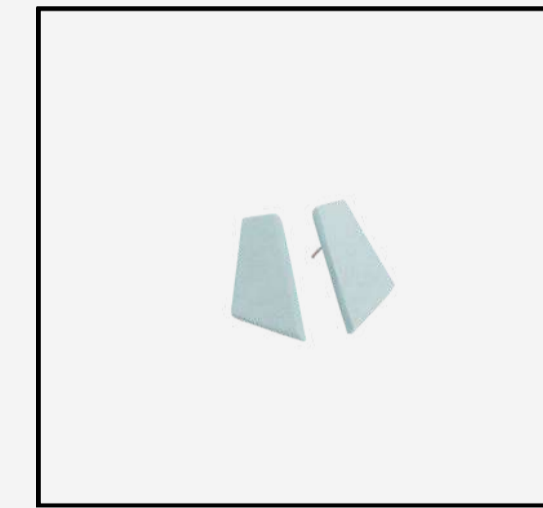

LIGHT-BLUE

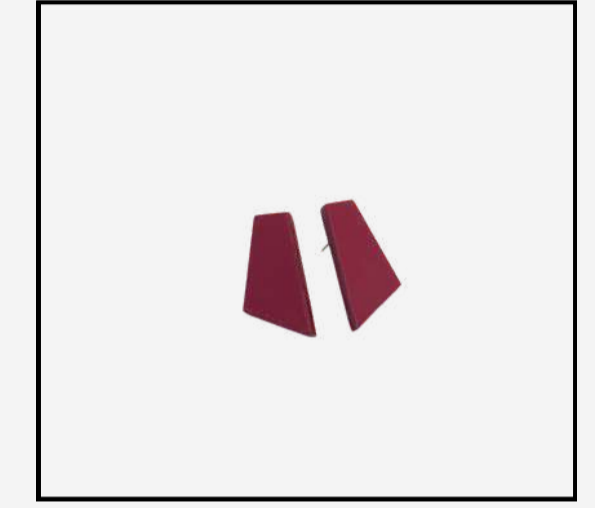

WINE

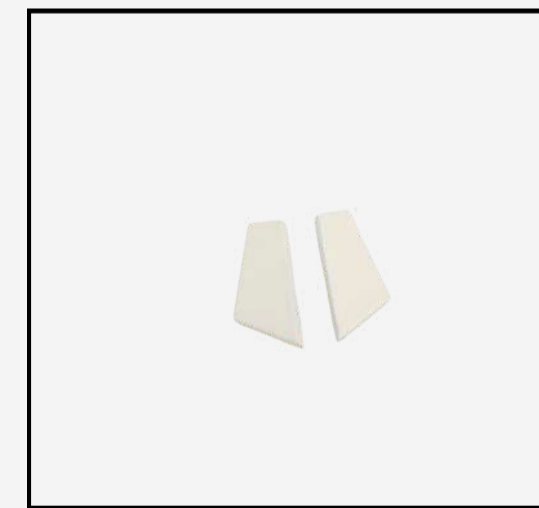

CREAM

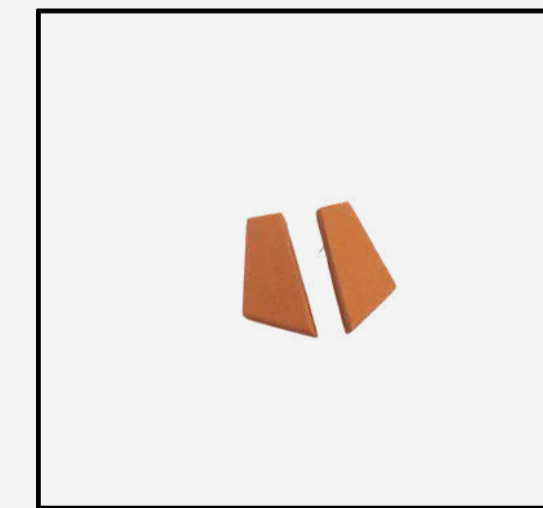

TANNED

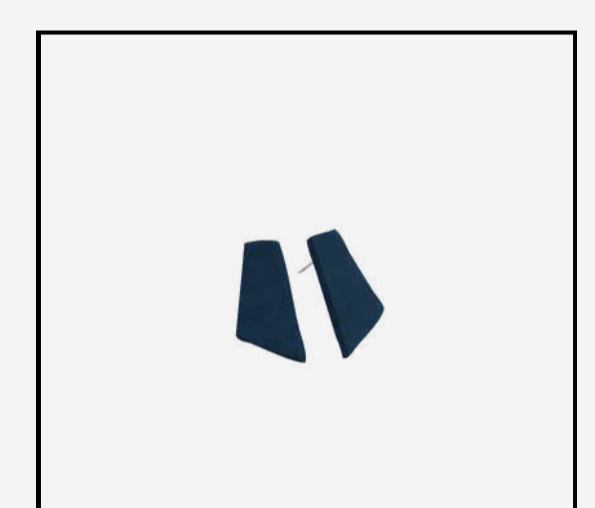

NAVY

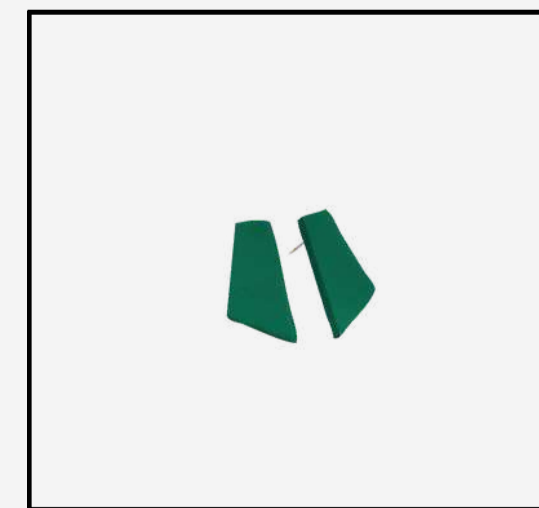

CLOVER GREEN

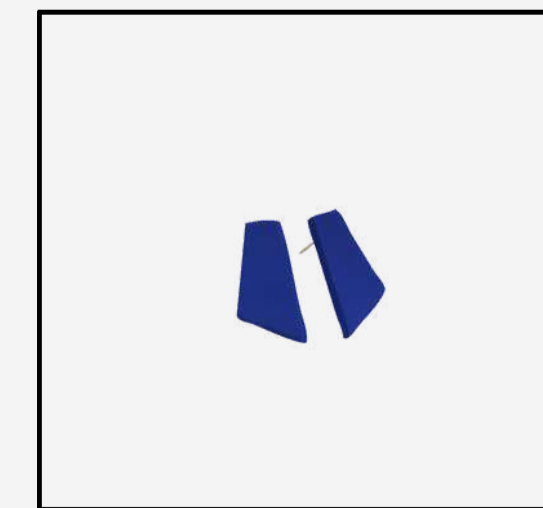

BIENHECHA BLUE

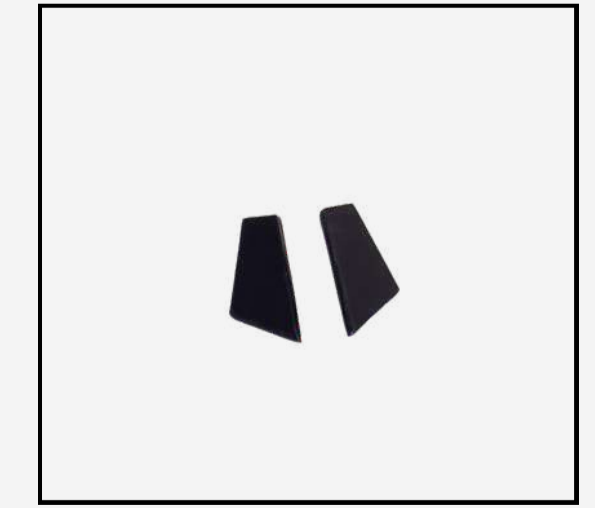

MAT BLACK



## EARRINGS

# IRENE

- Very light
- Antiallergic (the trimming is made of surgical steel)
- Handcrafted with small scraps of leather to reduce our waste and make the most of everything we have in the workshop
- Hand-painted and polished edges, one by one
- Sizes: 2 cm (in its wider part) x 5 cm (more or less, as they're handmade :))
- Order them in your colour palette

SHOP

RETAIL PRICE: 44,95€

\*Sign in to your account to see your wholesale price

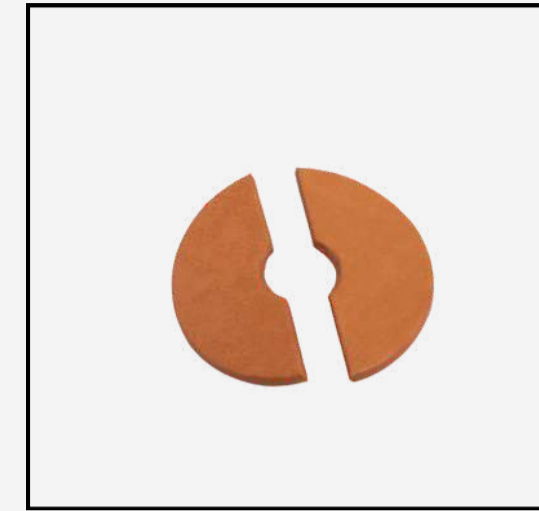

BRICK

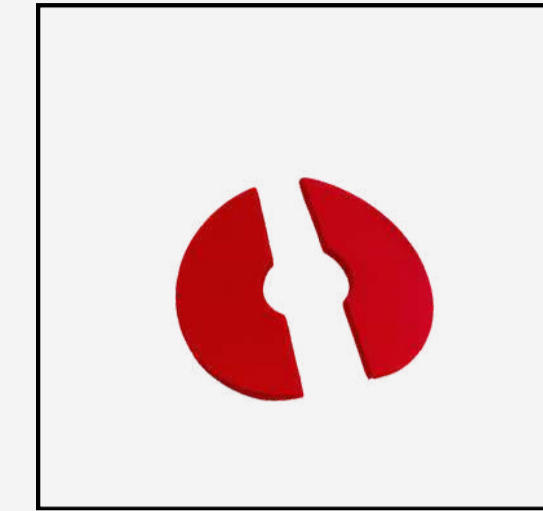

RED



BOOM BLACK

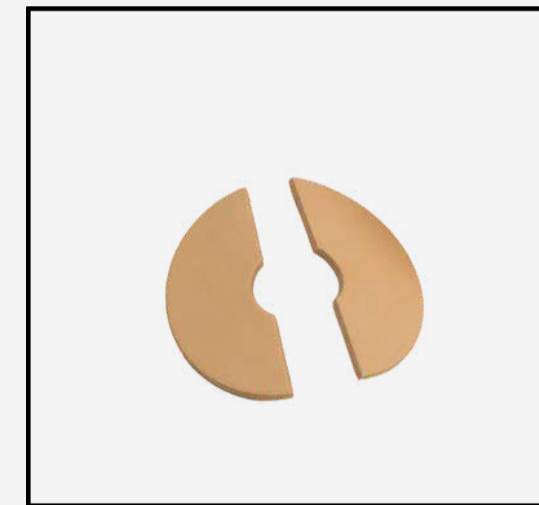

NUDE

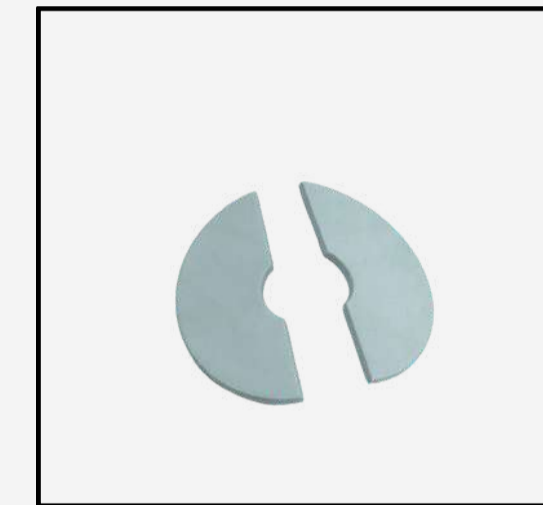

LIGHT-BLUE

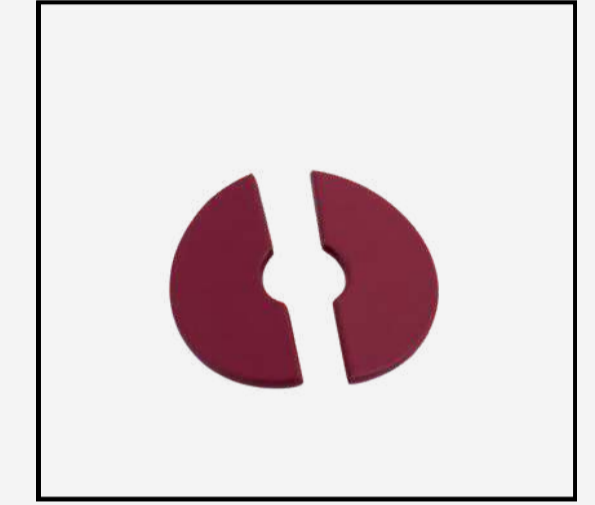

WINE

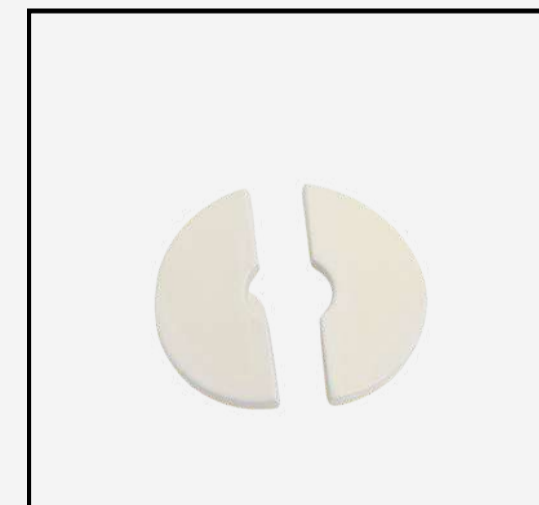

CREAM

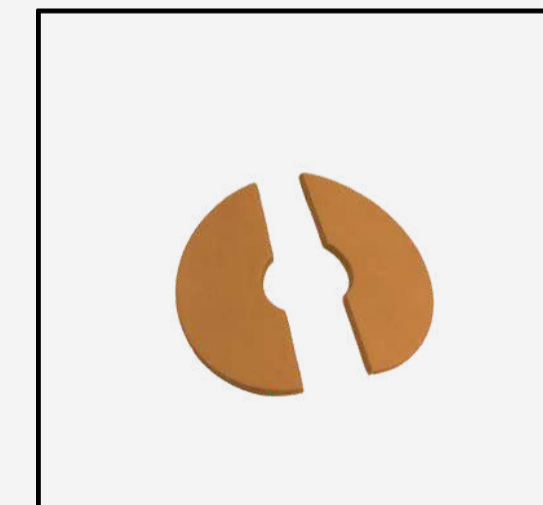

TANNED

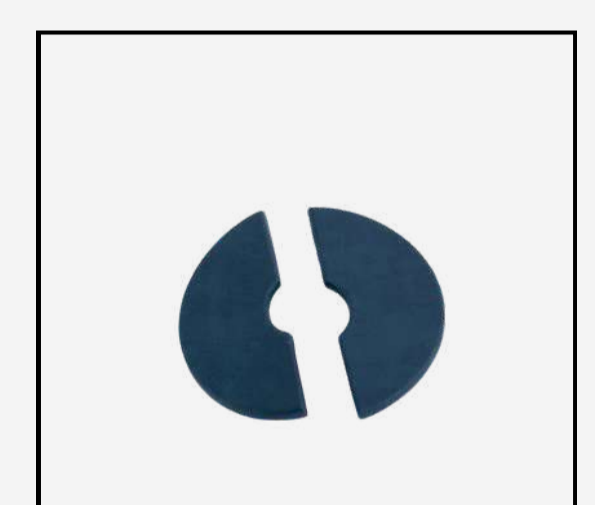

NAVY

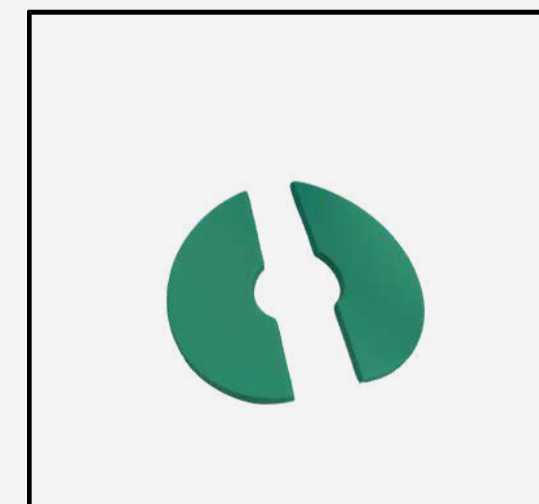

CLOVER GREEN

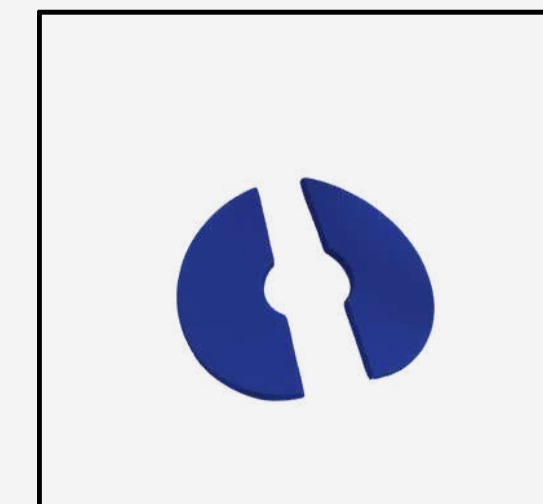

BIENHECHA BLUE

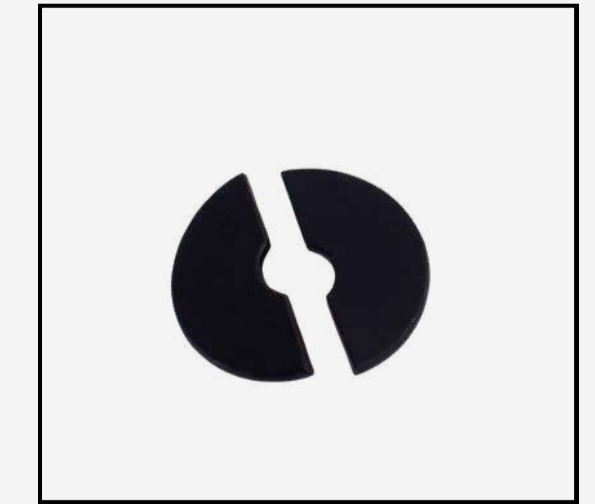

MAT BLACK



## EARRINGS

# ANA

- Very light
- Antiallergic (the trimming is made of surgical steel)
- Handcrafted with small remains of leather to reduce our waste and make the most of everything we have in the workshop
- Hand-painted and polished edges, one by one
- Sizes: 2'5 cm (in its wider part) x 3 cm (more or less, as they're handmade :))
- Order them in your colour palette

SHOP

RETAIL PRICE: 44,95€

\*Sign in to your account to see your wholesale price

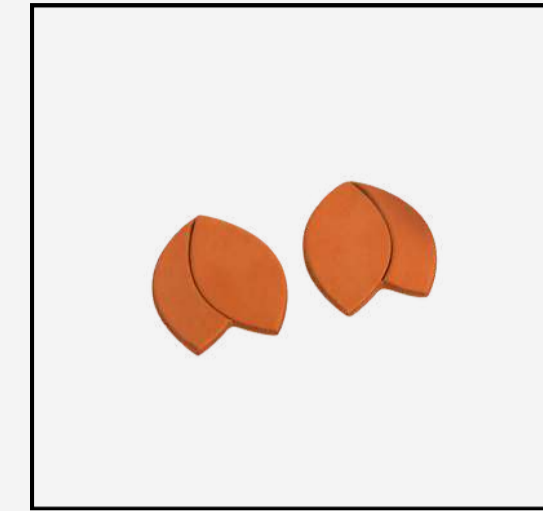

BRICK

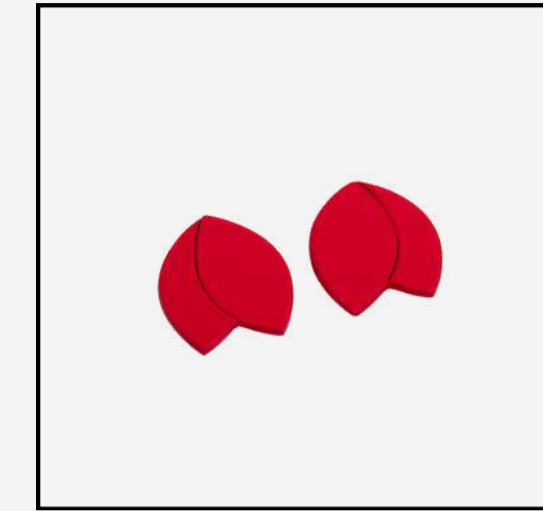

RED



BOOM BLACK

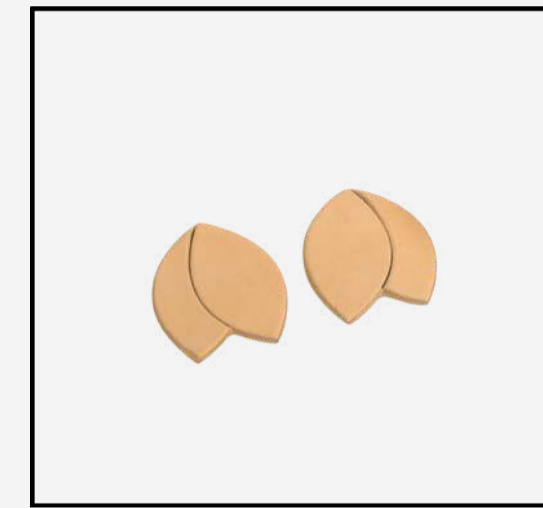

NUDE

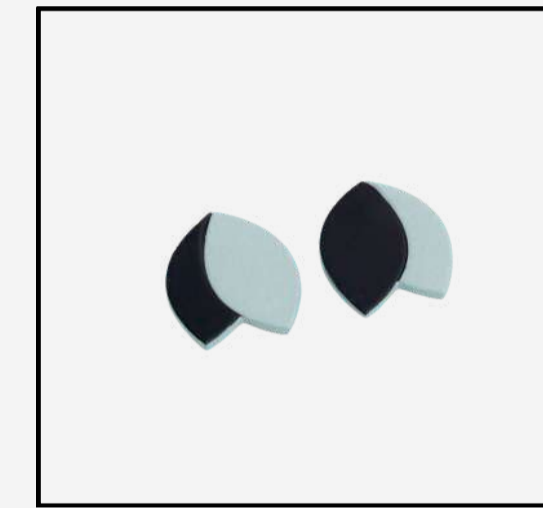

LIGHT-BLUE

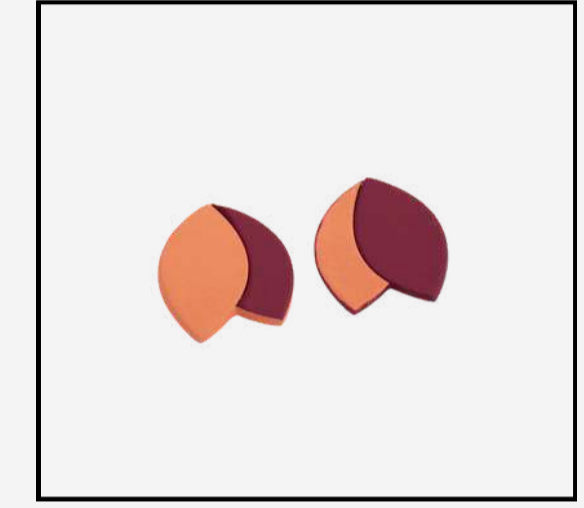

WINE

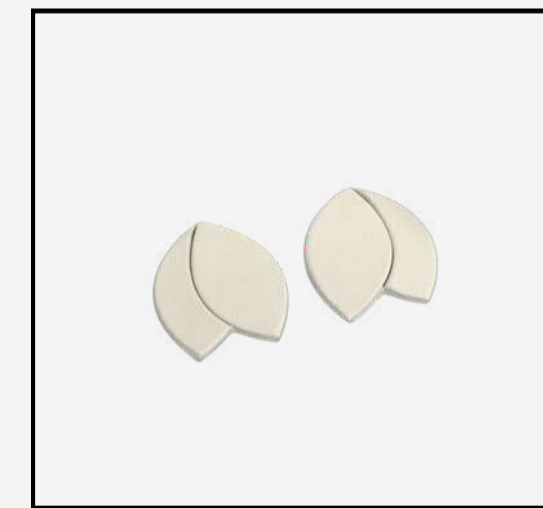

CREAM



TANNED



NAVY

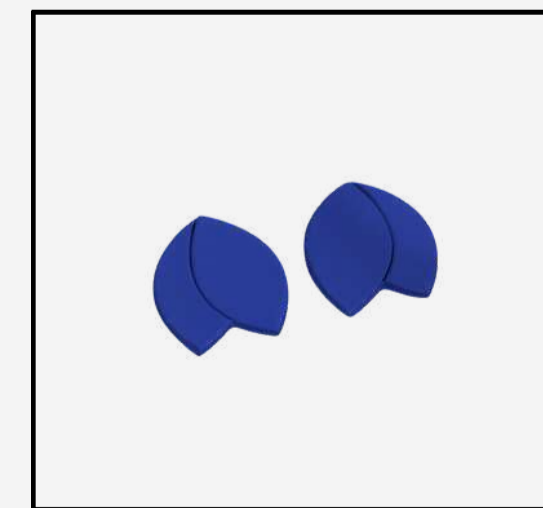

CLOVER GREEN

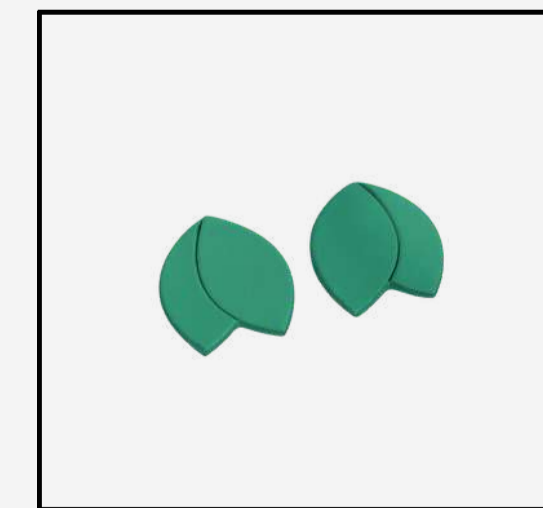

BIENHECHA BLUE

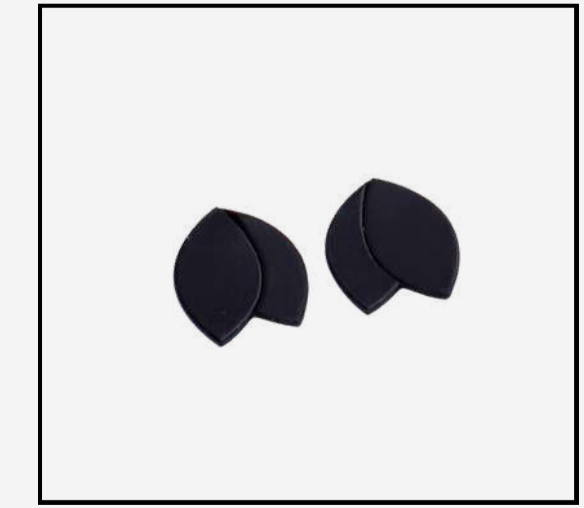

MAT BLACK



## EARRINGS

# CRISTINA

- Very light
- Antiallergic (the trimming is made of surgical steel)
- Handcrafted with small remains of leather to reduce our waste and make the most of everything we have in the workshop
- Hand-painted and polished edges, one by one
- Sizes: 1'5 cm (in its wider part) x 2'5 cm (more or less, as they're handmade :))
- Order them in your colour palette

SHOP

RETAIL PRICE: 54,95€

\*Sign in to your account to see your wholesale price



BRICK

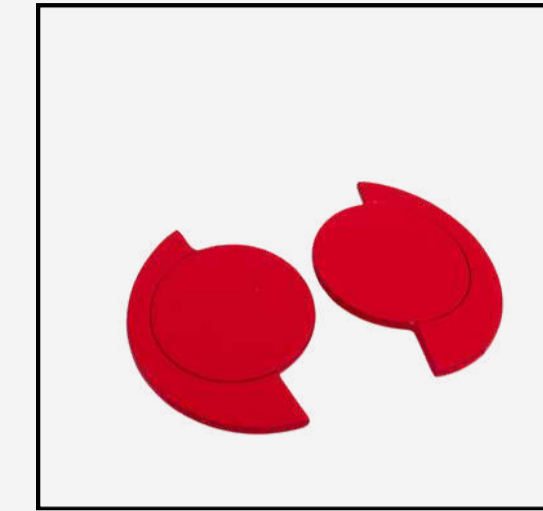

RED



BOOM BLACK

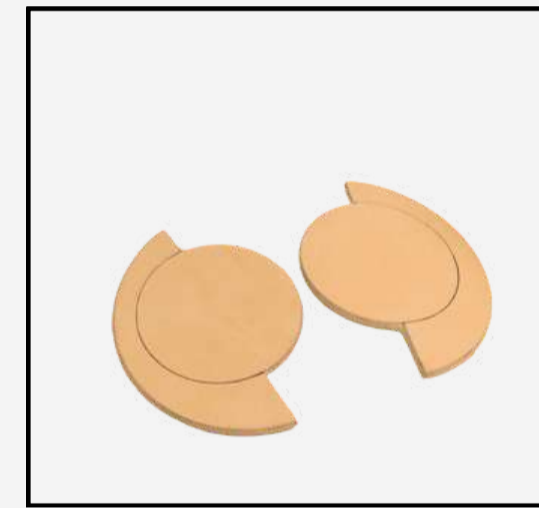

NUDE



LIGHT-BLUE

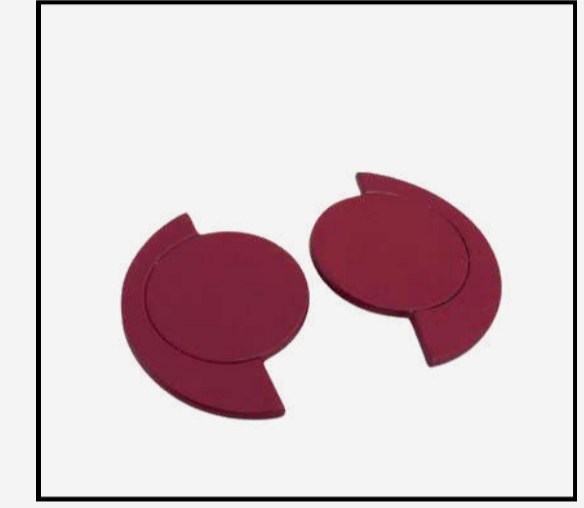

WINE

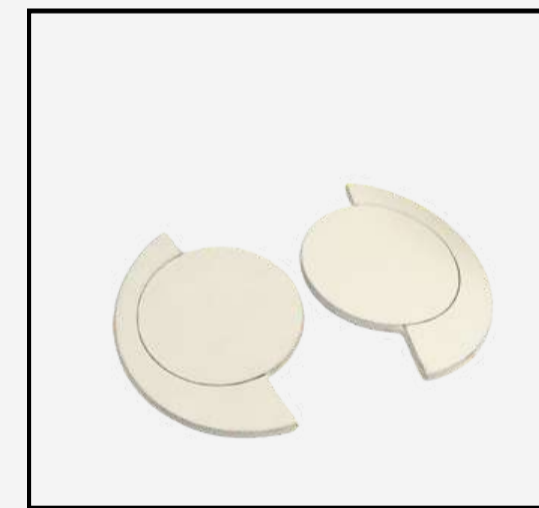

CREAM



TANNED



NAVY

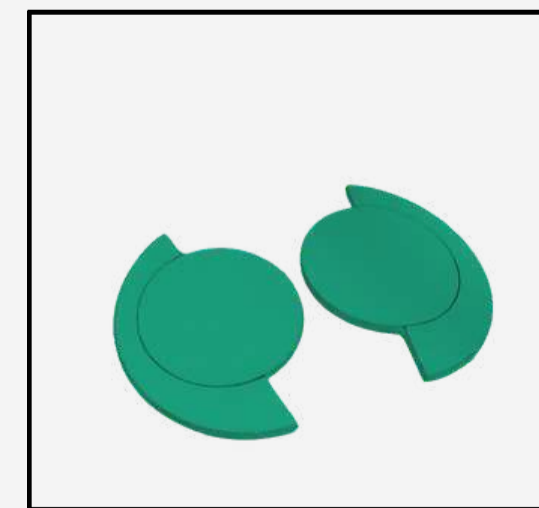

CLOVER GREEN

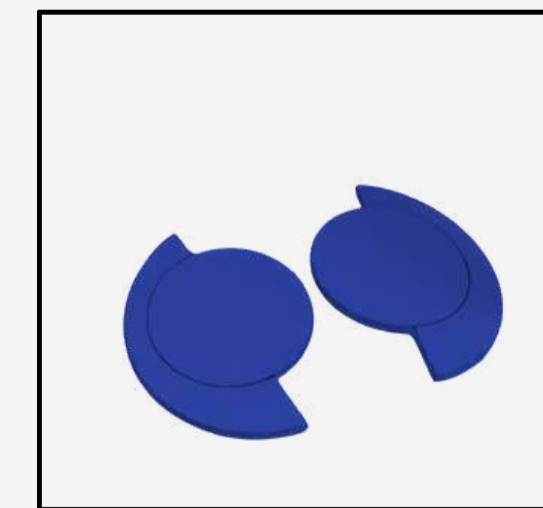

BIENHECHA BLUE

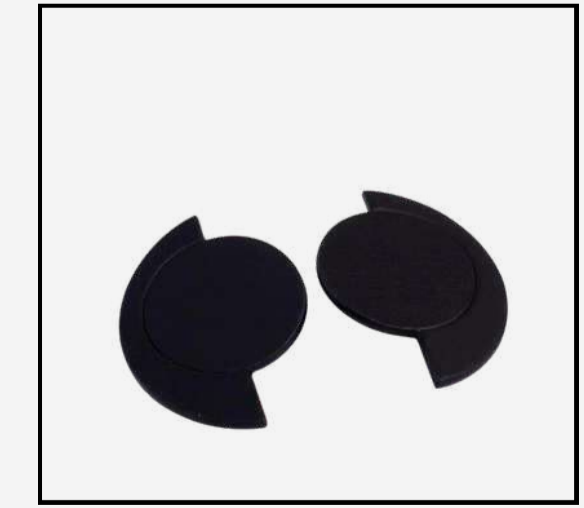

MAT BLACK





SOFTIES

## VEGAN COLLECTION

The hit of 2023. A 100% vegan and plastic-free collection. Yes, you heard that right: it's a non-petroleum-derived material. No PVC or PU. Just 100% silicone and organic cotton. Waterproof, resistant, non-staining, anti-allergic and supersoft.

DISCOVER



BEST SELLER

# THE ÁNGELAS

Our collection of buckets in 4 sizes and 10 colours.  
They became a best seller from minute one.

DISCOVER



ANGELITA

DISCOVER →



ANGELINES

DISCOVER →



ÁNGELA

DISCOVER →



DOÑA ÁNGELA

DISCOVER →



WANTED

# LAS JUANAS

Our tote collection in 3 sizes and 10 colours. You'll love their minimalist design and large capacity.

DISCOVER



JUANITA

DISCOVER →



JUANI

DISCOVER →



JUANA

DISCOVER →



SUPER PRACTICAL

## THE FERNANDAS

Our collection of baguettes in 2 sizes and 10 colours. Practical, versatile and with that minimalist design that characterises us so much.

DISCOVER



FERNANDITA

DISCOVER →



FERNANDA

DISCOVER →



NEW!

# LAS ADELAS

The latest silicone collection. Multi-position bags, superversatile, comfortable and with a design that will drive anyone crazy.

DISCOVER



ADELITA

DISCOVER →



ADELINA

DISCOVER →



ADELA

DISCOVER →



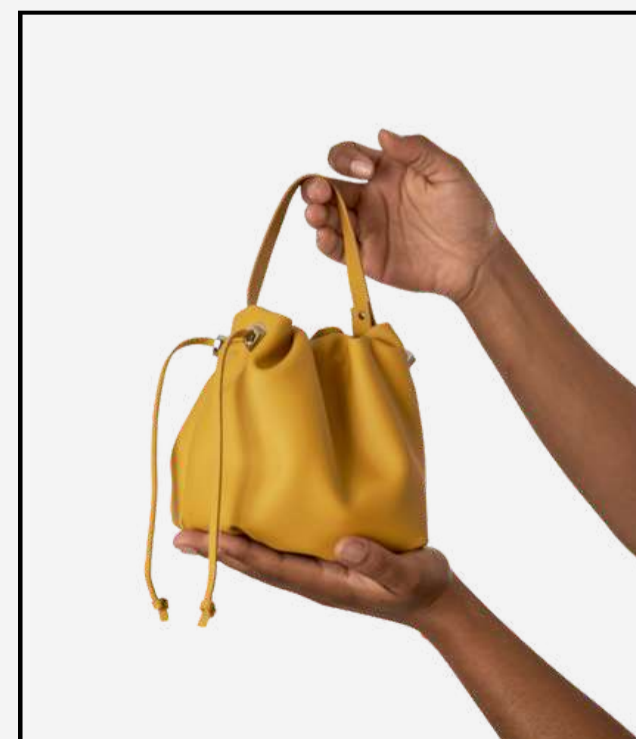
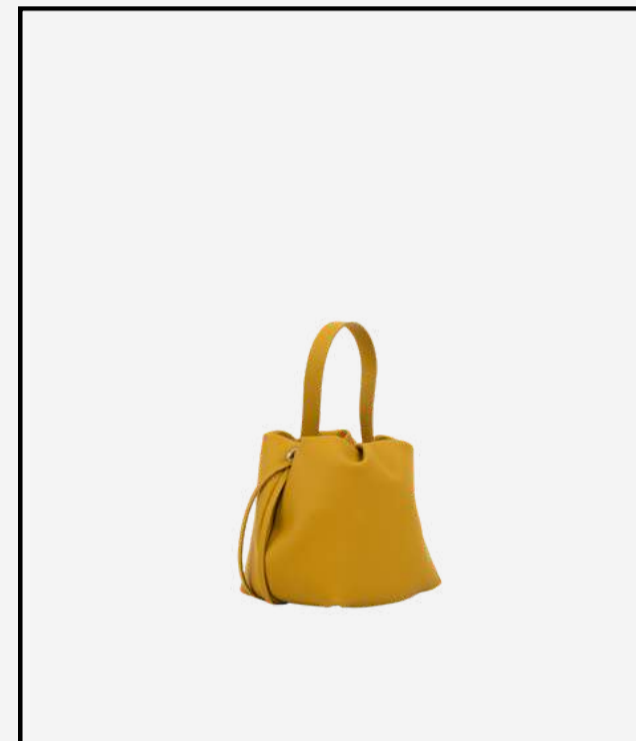
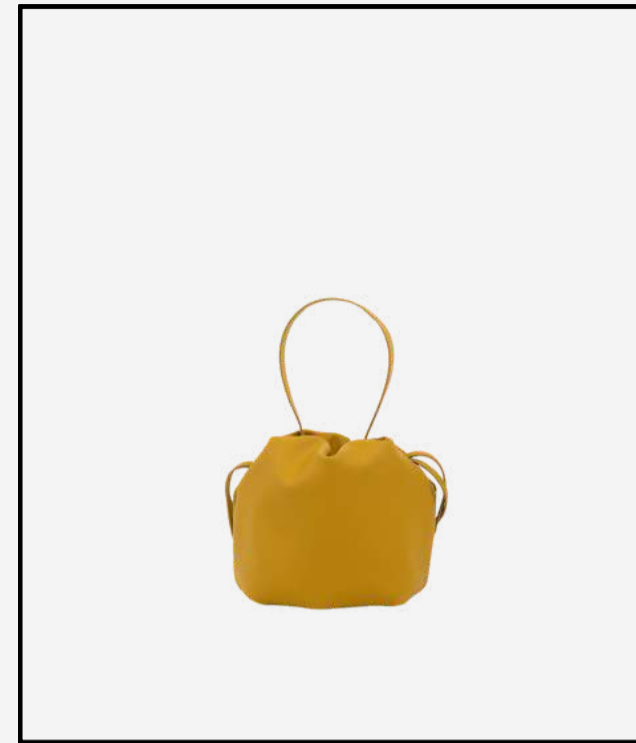
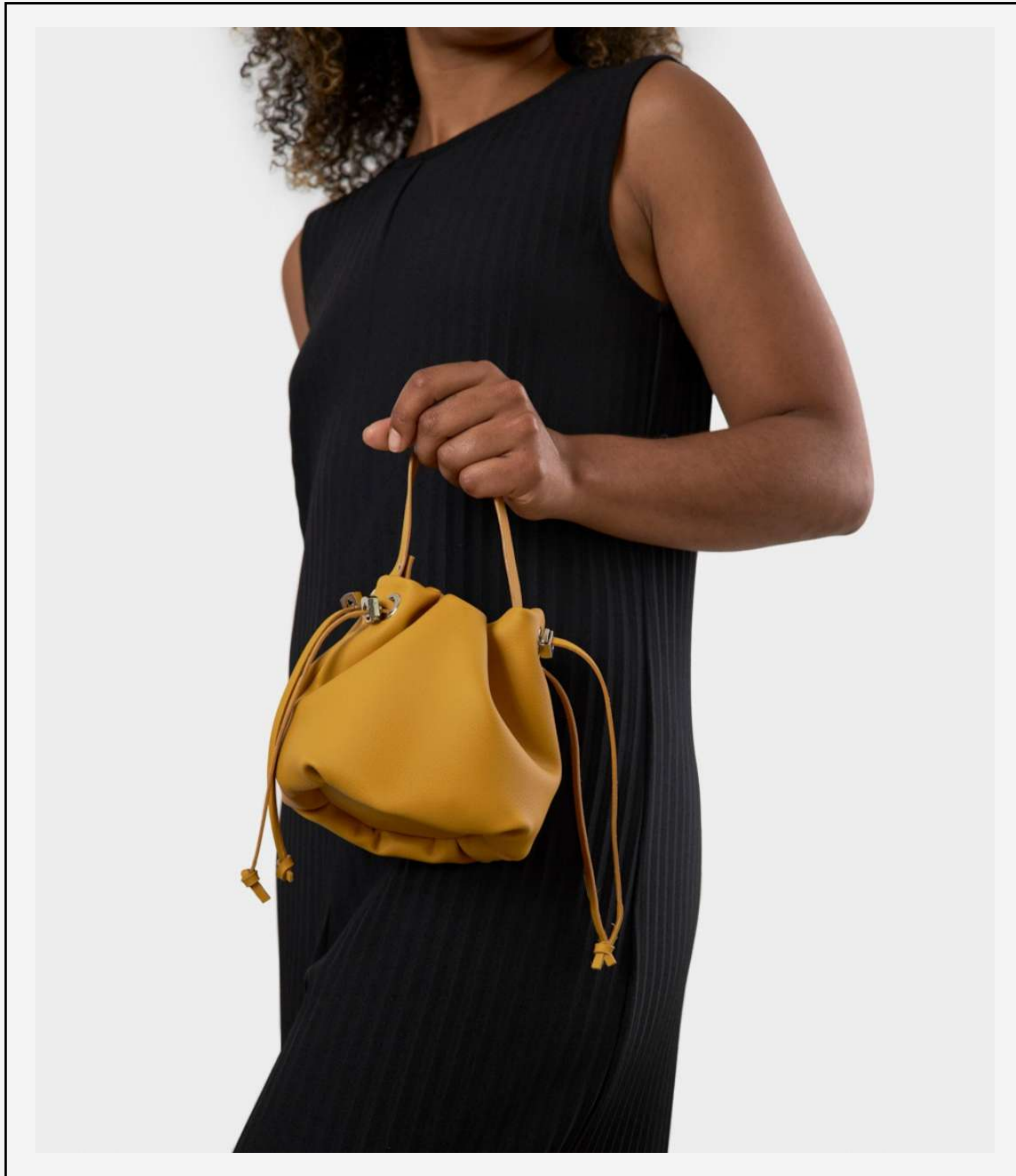

**BEST SELLER**

## **ANGELITA**

The smallest of the family of four ("Las Ángelas"). Small but tough. To carry the basics without sacrificing design.

**DISCOVER**



BEST SELLER

# ANGELITA

- Magnet fastener + adjustable cord
- Outside made of vegan Biomaterial 100% silicone and plastic-free
- Inside made of very soft organic cotton canvas with GOT certificate
- Waterproof, very resistant to scratches and stains, hypoallergenic, odorless...
- Interchangeable 30 cm hand strap and 120 cm crossbody strap included
- Reinforced base to keep its shape
- Extra straps available: 60 cm, 70 cm, 80 cm, 100 cm, 120 cm or 140 cm

SHOP

EXTRAS

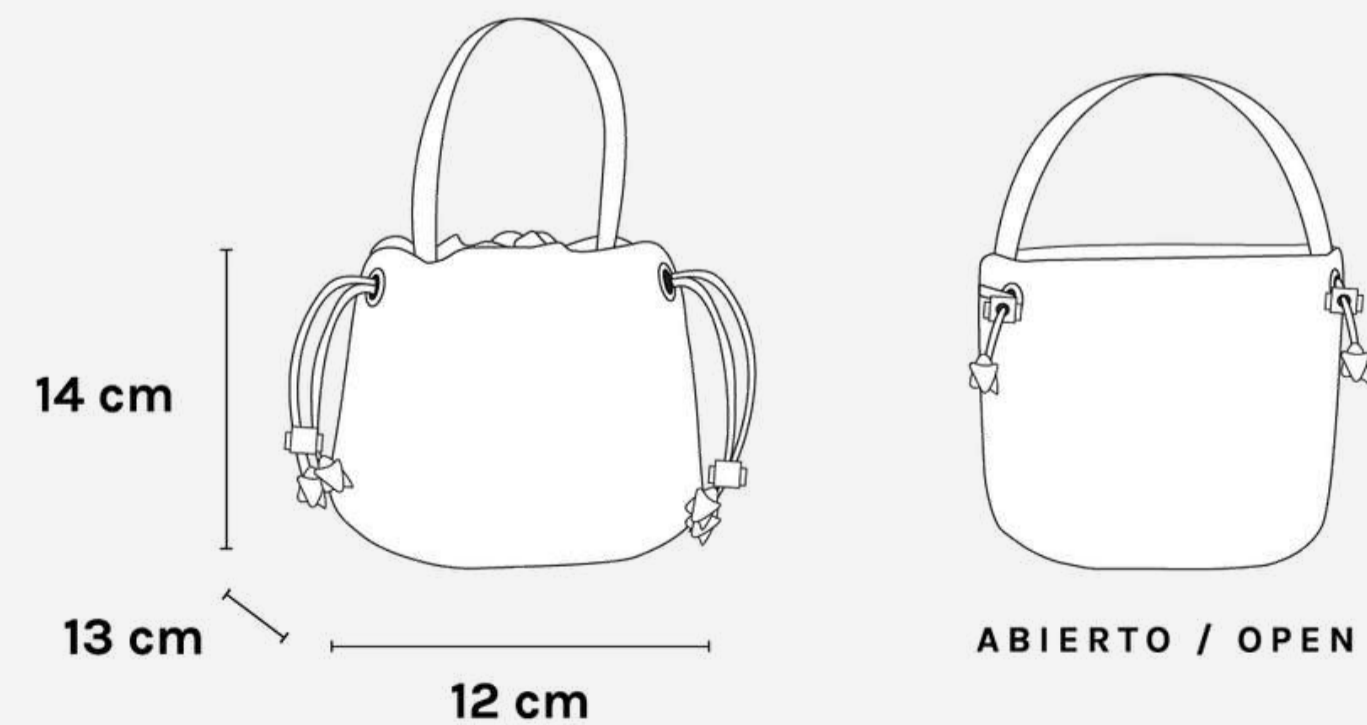

BLACK



OLIVE GREEN



YELLOW



SKY BLUE



LEMON CREAM

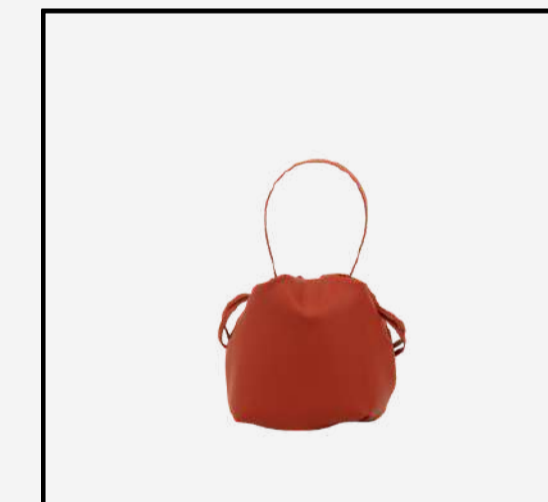

BRICK RED

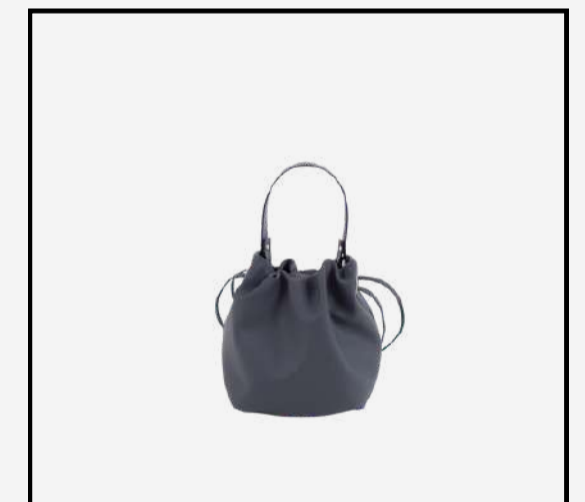

FANCY GREY

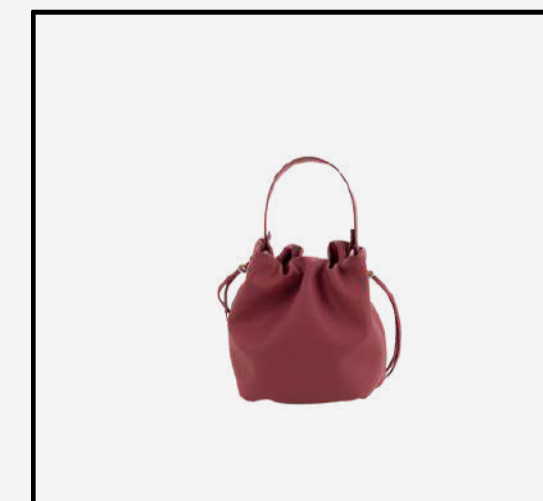

MAROON



STONE GREY



MOSS BLUE





POSITIONS | \* The model is 1.70 m tall

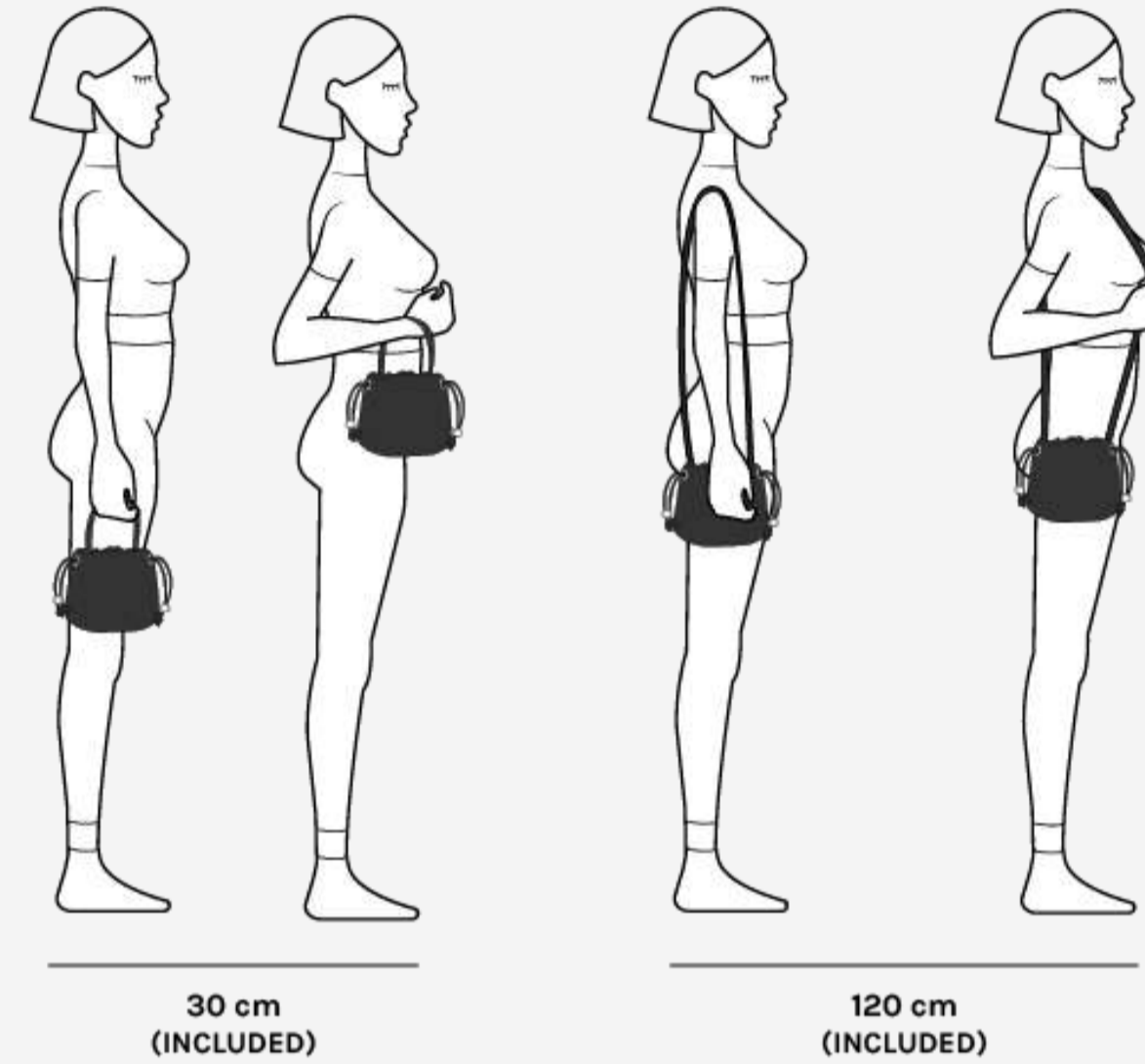

BEST SELLER

## ANGELITA

SHOP

RETAIL PRICE: 139,95€

\*Sign in to your account to see your wholesale price



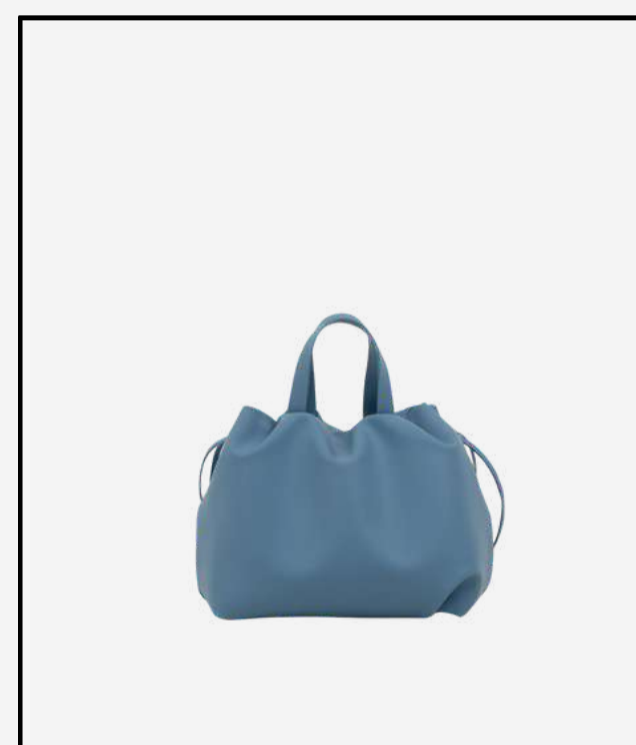
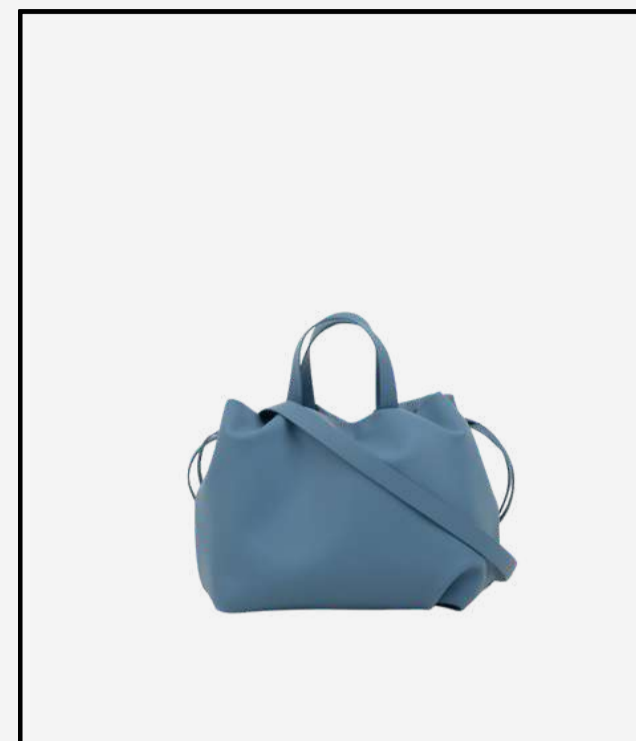
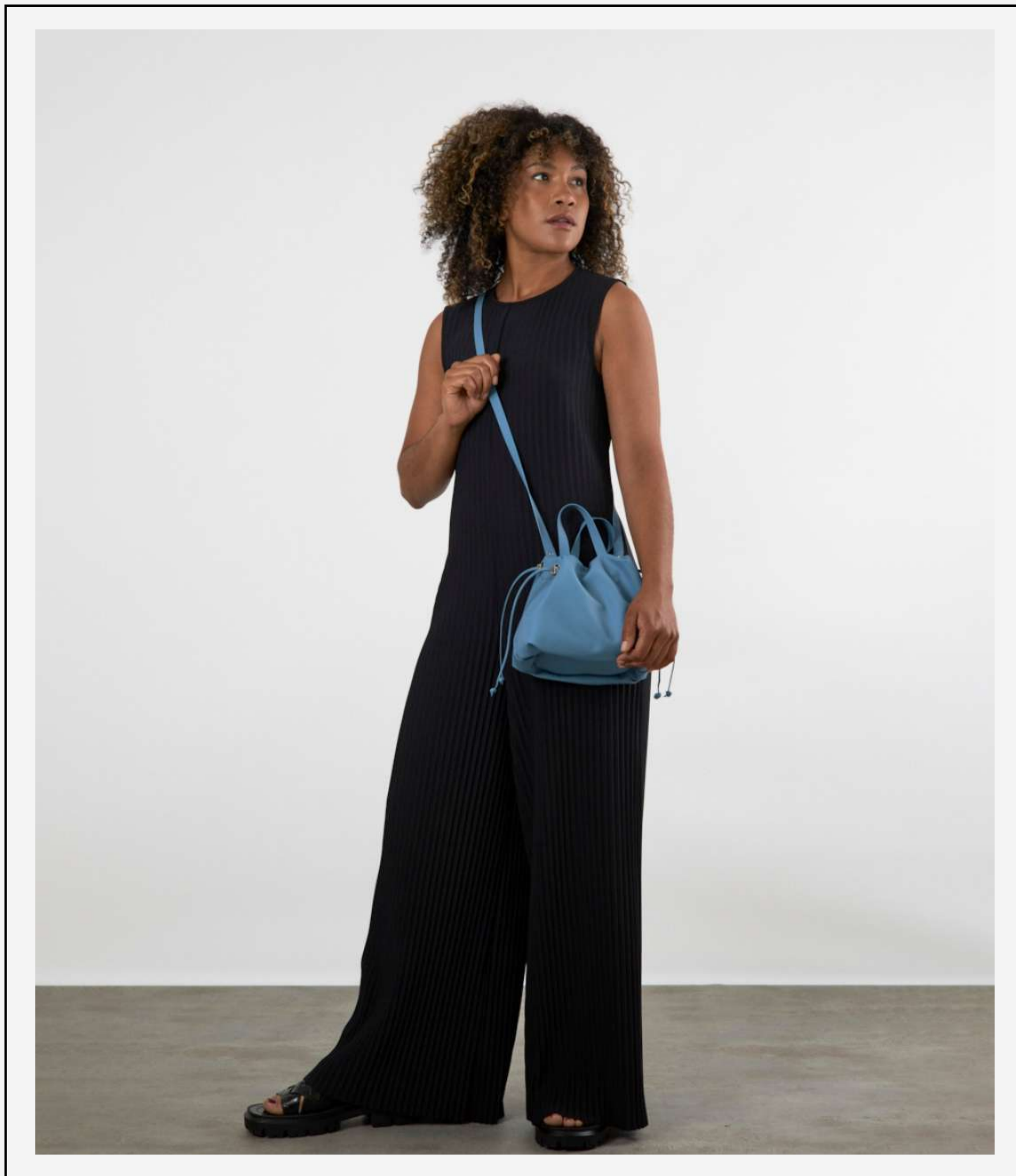

BEST SELLER

## ANGELINES

Angelines is a perfect everyday bucket with a very pure, original and minimalist design. Super practical size and very light weight.

DISCOVER



BEST SELLER

# ANGELINES

- Magnet fastener + adjustable strap
- Outside made of vegan Biomaterial 100% silicone and plastic-free
- Inside made of very soft organic cotton canvas with GOT certificat
- Waterproof, very resistant to scratches and stains, hypoallergenic, odorless...
- Two integrated 30 cm handles also a strap of 120 cm included (interchangeable)
- Reinforced base to keep its shape
- Extra straps available: 60 cm, 70 cm, 80 cm, 100 cm, 120 cm or 140 cm

SHOP

EXTRAS

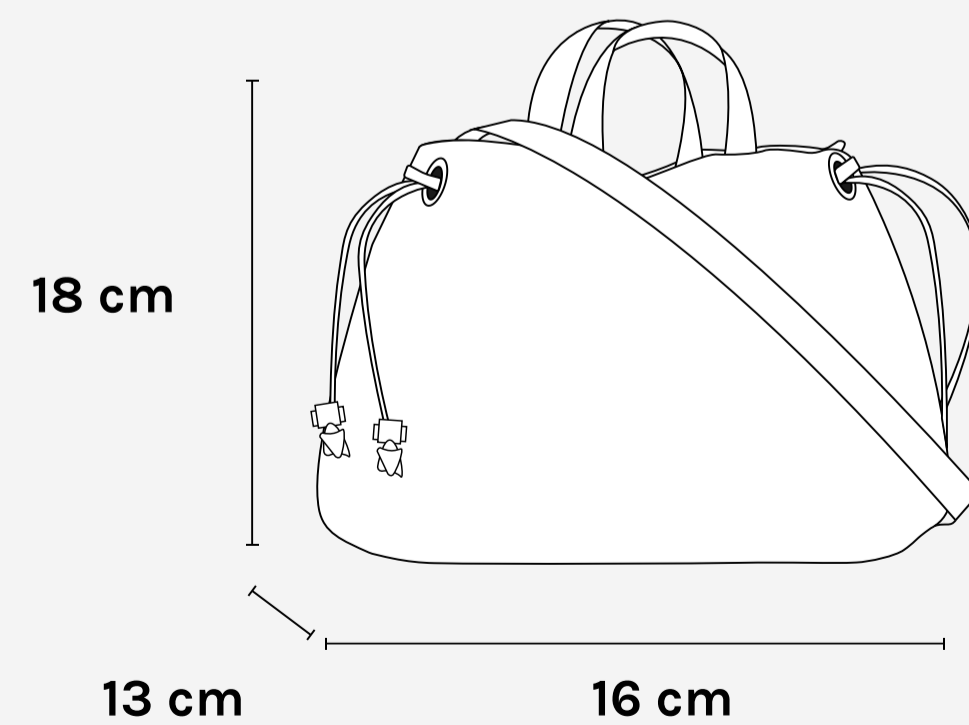

BLACK

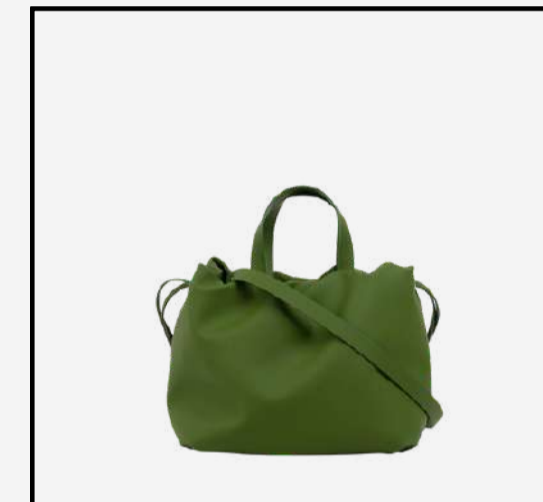

OLIVE GREEN

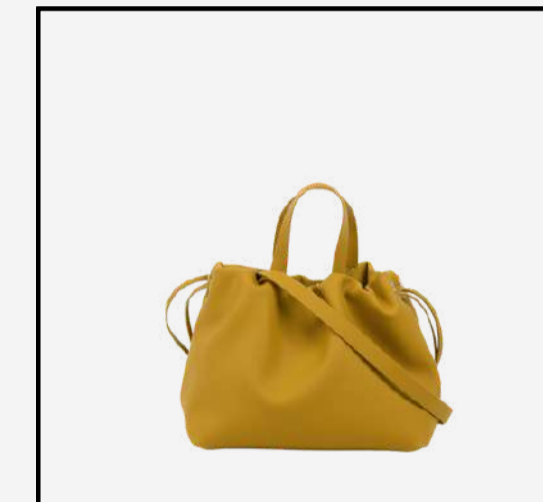

YELLOW



SKY BLUE

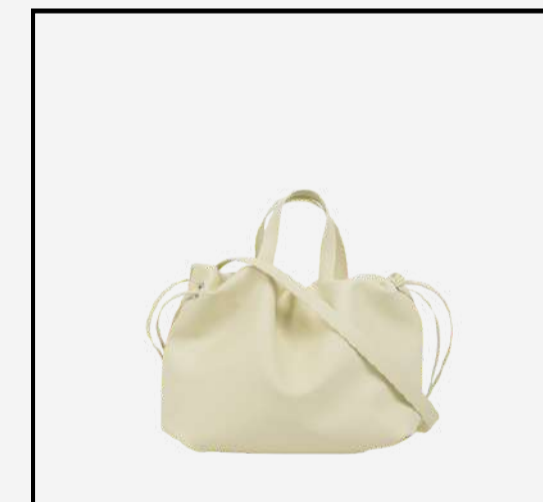

LEMON CREAM

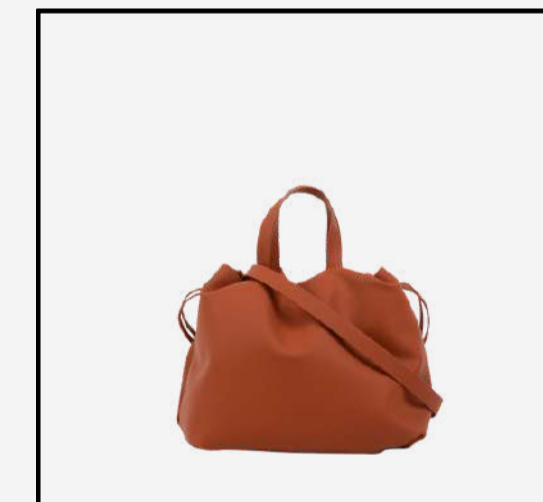

BRICK RED

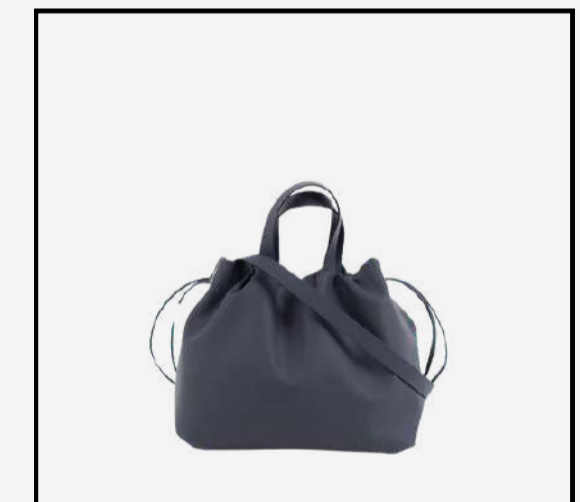

FANCY GREY

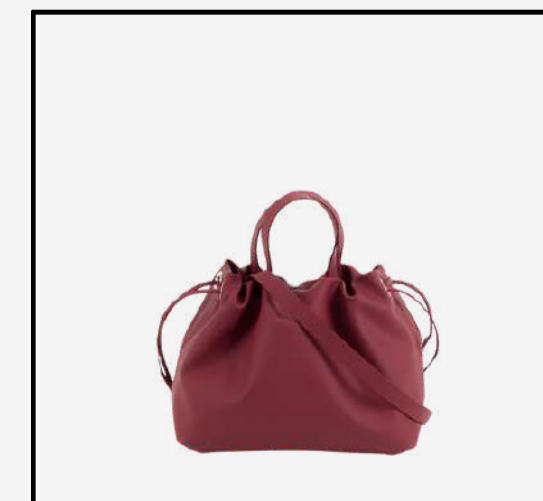

MAROON

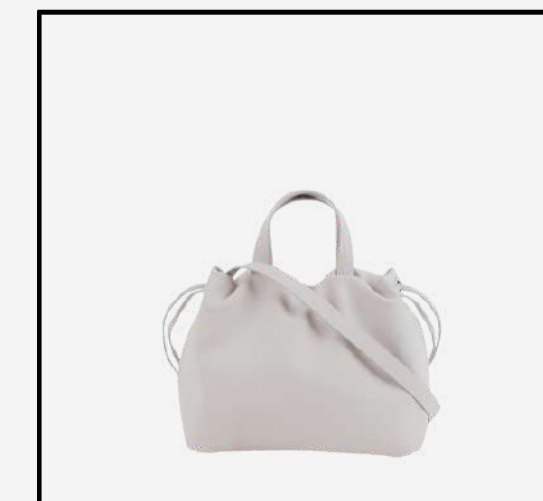

STONE GREY



MOSS BLUE





POSITIONS | \* The model is 1.70 m tall

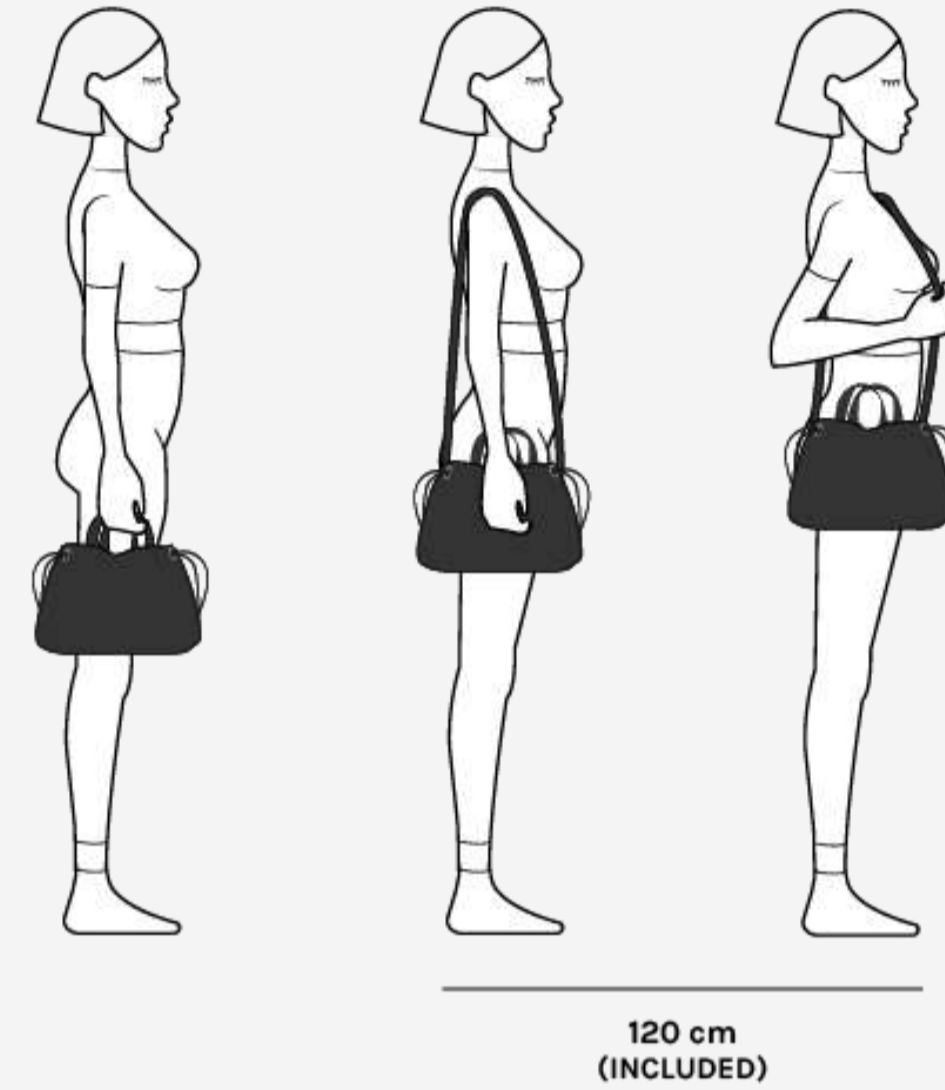

BEST SELLER

## ANGELINES

SHOP

RETAIL PRICE: 179,95€

\*Sign in to your account to see your wholesale price



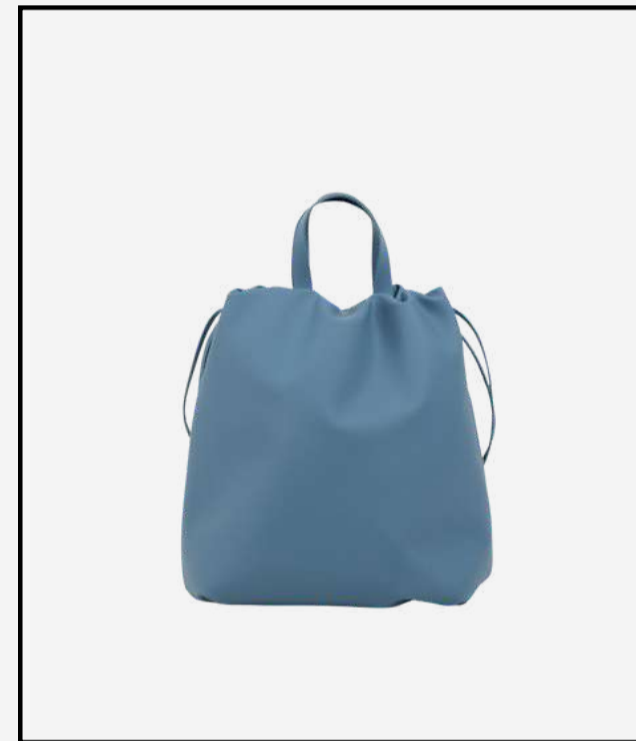
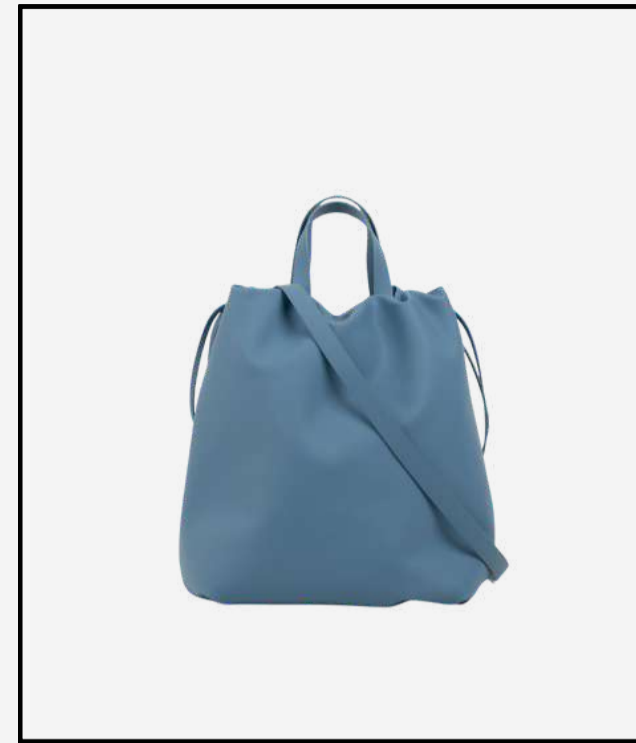

BEST SELLER

## ÁNGELA

Bucket bag with one of those sizes that makes life easier without compromising on a super-original, simple and minimalist design. Practical and lightweight are its two surnames.

DISCOVER



BEST SELLER

# ÁNGELA

- Magnet fastener + adjustable strap
- Outside made of vegan Biomaterial 100% silicone and plastic-free
- Inside made of very soft organic cotton canvas with GOT certificate
- Waterproof, very resistant to scratches and stains, hypoallergenic, odorless...
- Two integrated 30 cm handles also a strap of 120 cm included (interchangeable)
- Reinforced base to keep its shape
- Extra straps available: 60 cm, 70 cm, 80 cm, 100 cm, 120 cm or 140 cm

SHOP

EXTRAS

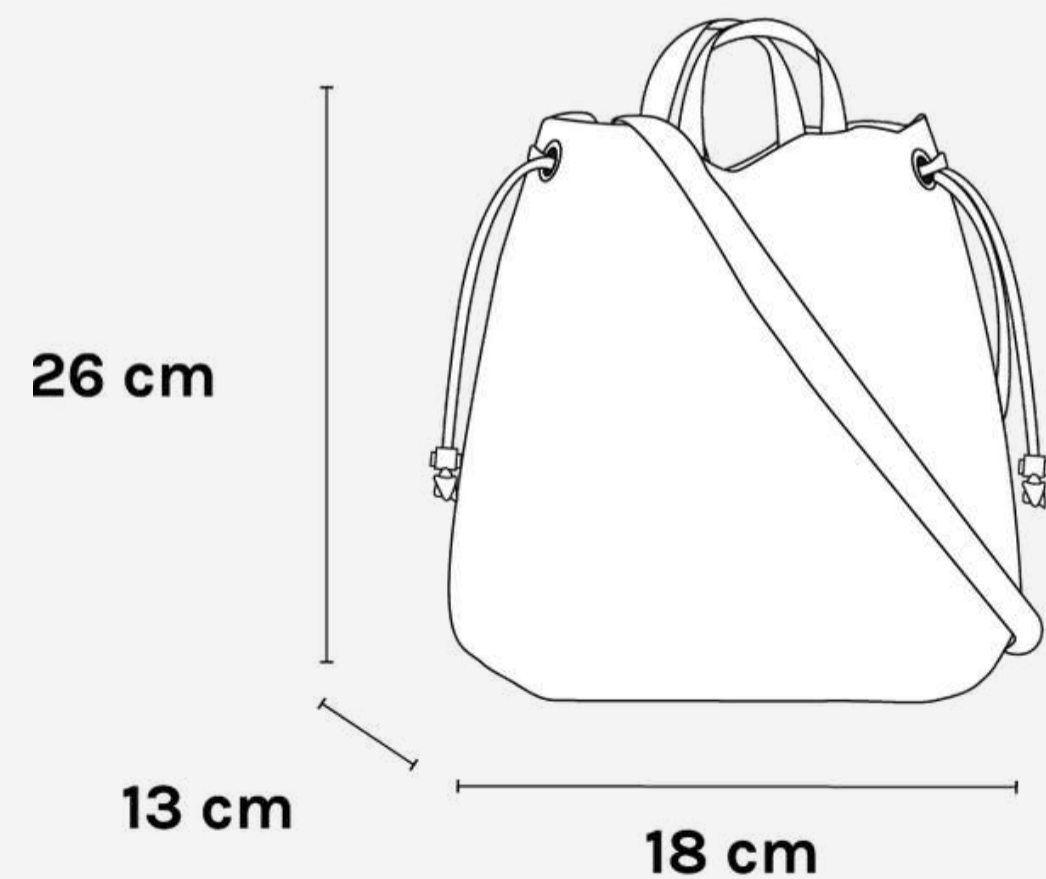

BLACK



OLIVE GREEN



YELLOW



SKY BLUE



LEMON CREAM

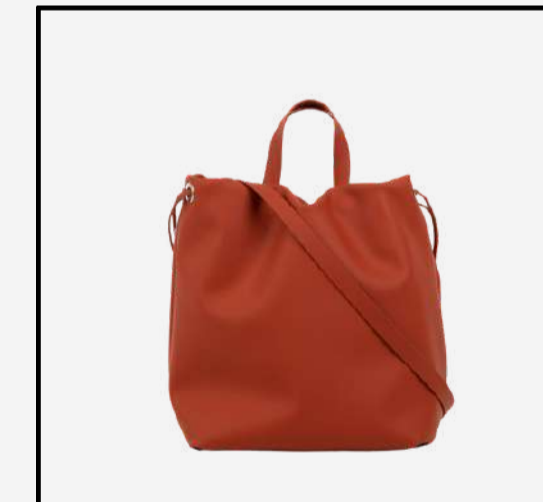

BRICK RED



FANCY GREY

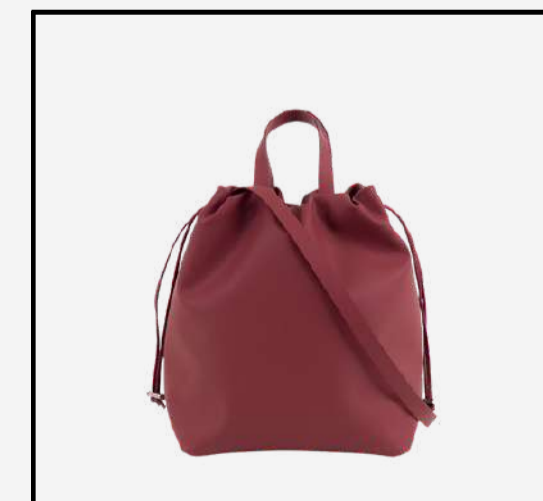

MAROON

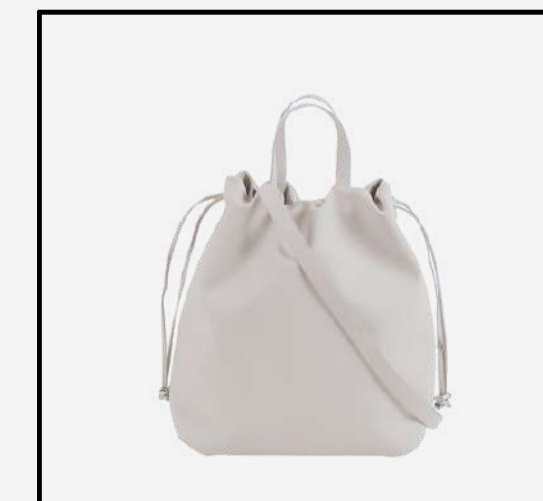

STONE GREY



MOSS BLUE





POSITIONS | \* The model is 1.70 m tall

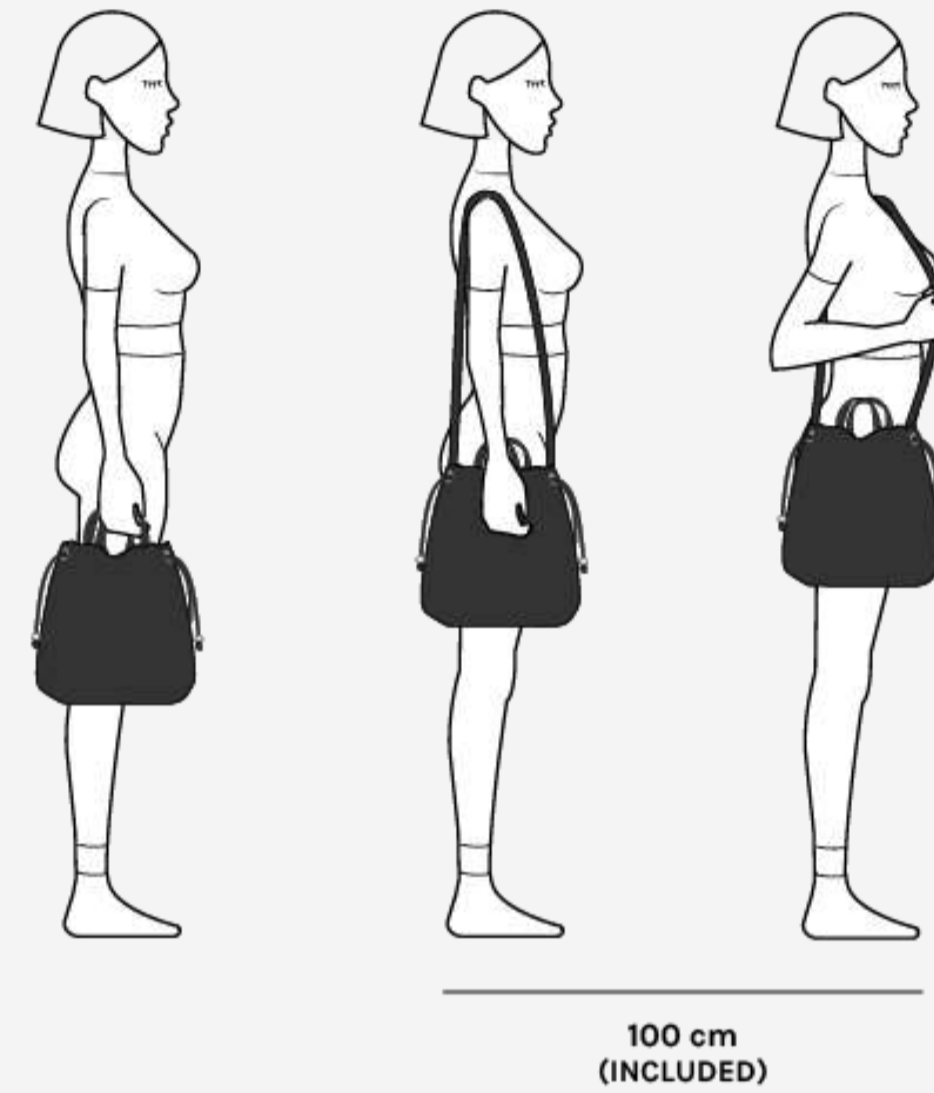

BEST SELLER

## ÁNGELA

SHOP

RETAIL PRICE: 239,95€

\*Sign in to your account to see your wholesale price





BEST SELLER

## DOÑA ÁNGELA

Bucket bag / maxi shopper. The perfect bag for those looking for extra space without sacrificing design, it's also practical and lightweight!

DISCOVER



BEST SELLER

# DOÑA ÁNGELA

- Magnet fastener + adjustable strap
- Outside made of vegan Biomaterial 100% silicone and plastic-free
- Inside made of very soft organic cotton canvas with GOT certificate
- Waterproof, very resistant to scratches and stains, hypoallergenic, odorless...
- Two integrated 30 cm handles also a strap of 120 cm included (interchangeable)
- Reinforced base to keep its shape
- Extra straps available: 60 cm, 70 cm, 80 cm, 100 cm, 120 cm or 140 cm

SHOP

EXTRAS

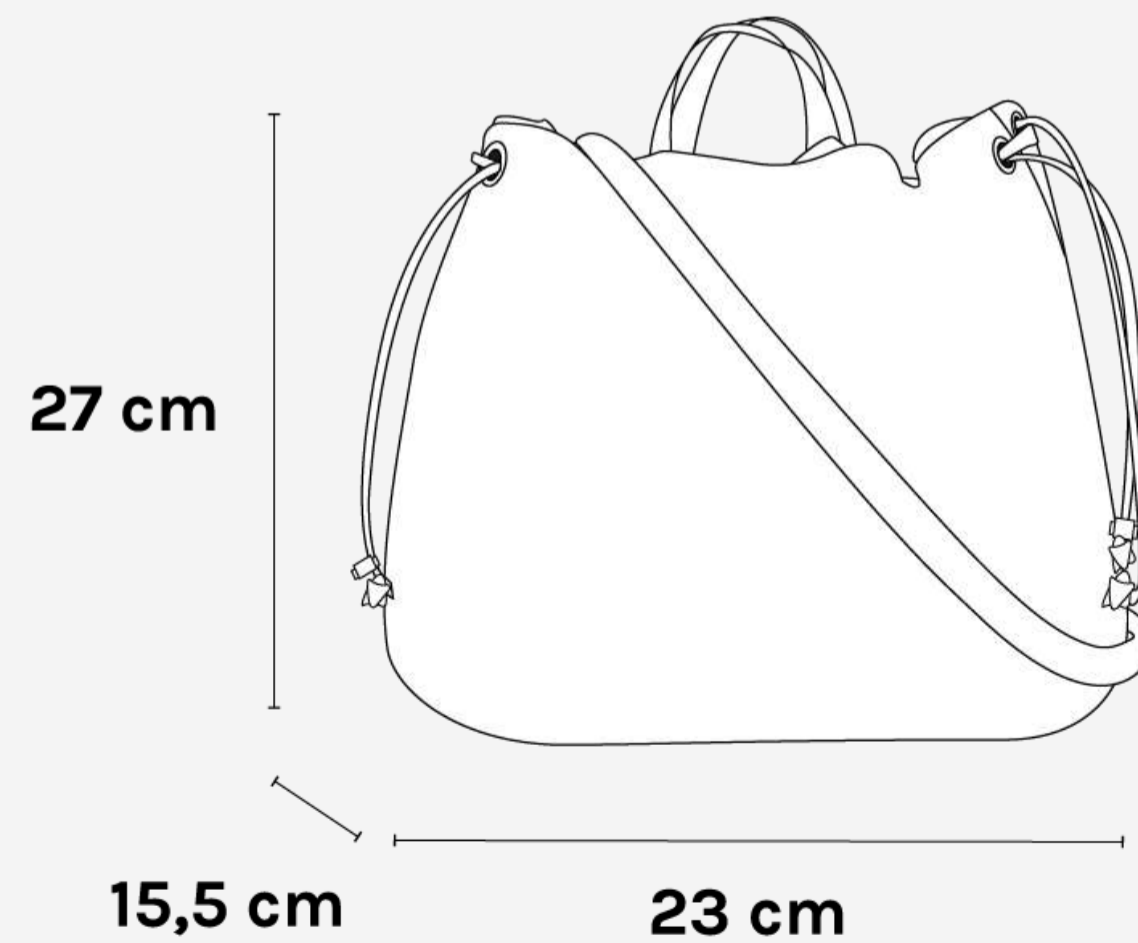

BLACK



OLIVE GREEN



YELLOW



SKY BLUE



LEMON CREAM



BRICK RED



FANCY GREY



MAROON



STONE GREY



MOSS BLUE





POSITIONS | \* The model is 1.70 m tall

---

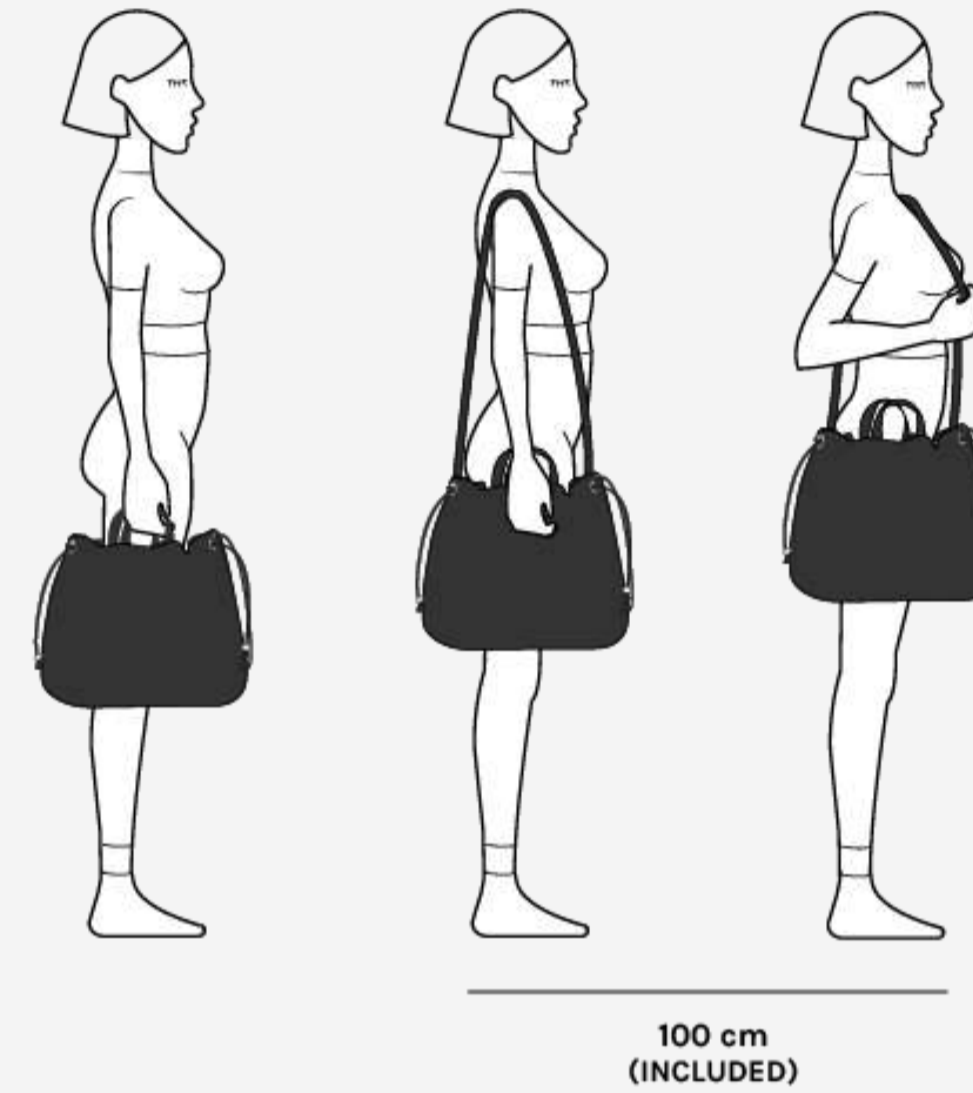

BEST SELLER

## DOÑA ÁNGELA

SHOP

RETAIL PRICE: 269,95€

\*Sign in to your account to see your wholesale price



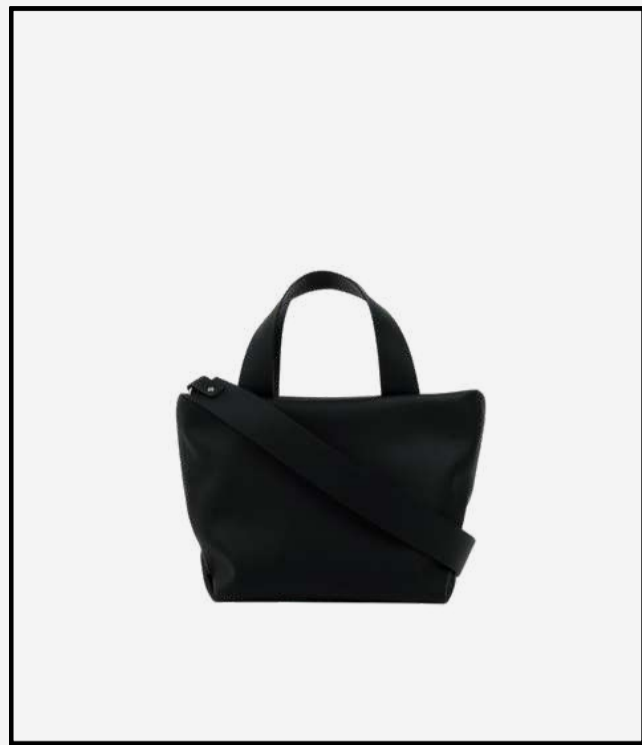

BEST SELLER

# JUANITA

One of those bags that won't go unnoticed. Soft, smooth and hard-wearing, it's a must-have for everyday use! Small but mighty.

DISCOVER



BEST SELLER

# JUANITA

- Zip fastener YKK
- Outside made of vegan Biomaterial 100% silicone and plastic-free
- Inside made of very soft organic cotton canvas with GOT certificate
- Waterproof, very resistant to scratches and stains, hypoallergenic, odorless...
- Two integrated 30 cm handles also a strap of 100 cm included (interchangeable)
- Reinforced base to keep its shape
- Extra straps available: 60 cm, 70 cm, 80 cm, 100 cm, 120 cm or 140 cm

SHOP

EXTRAS

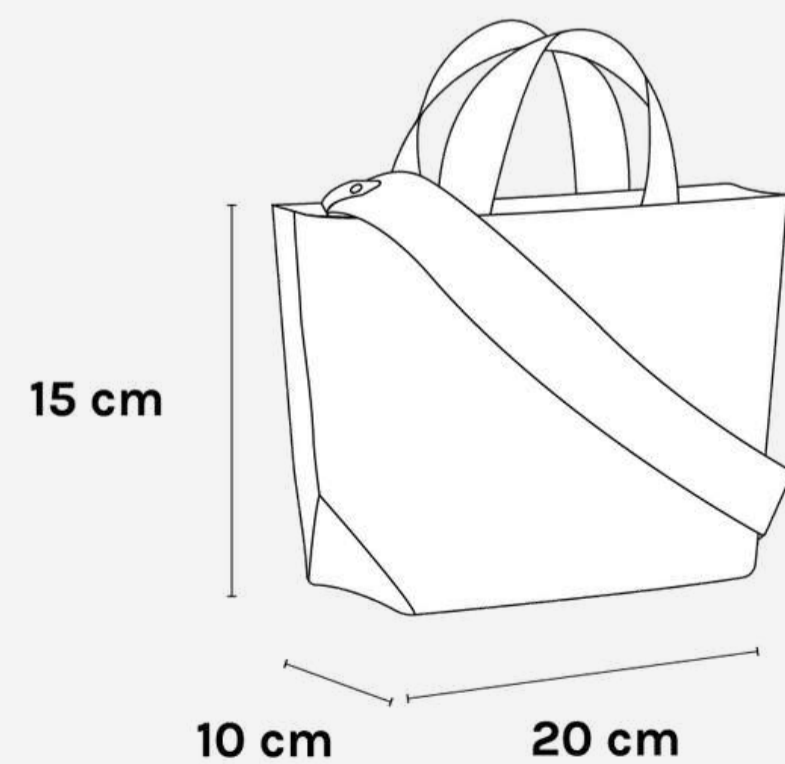

BLACK



OLIVE GREEN



YELLOW



SKY BLUE



LEMON CREAM

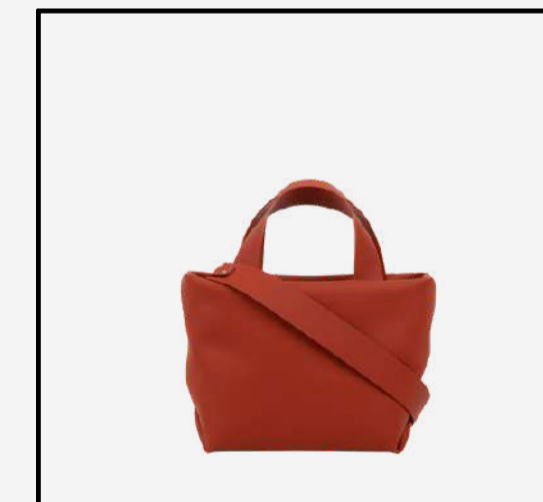

BRICK RED

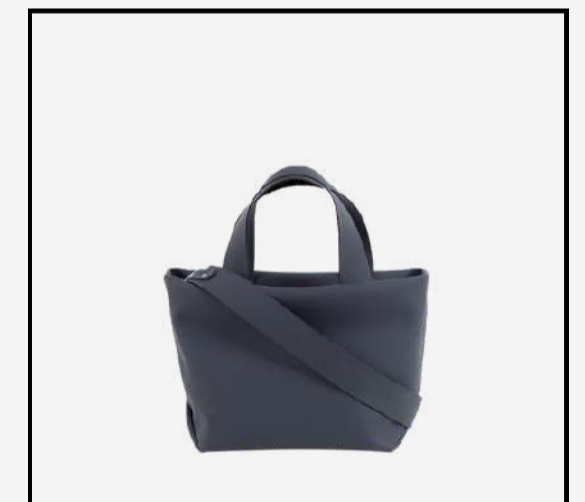

FANCY GREY



MAROON



STONE GREY



MOSS BLUE





POSITIONS | \* The model is 1.70 m tall

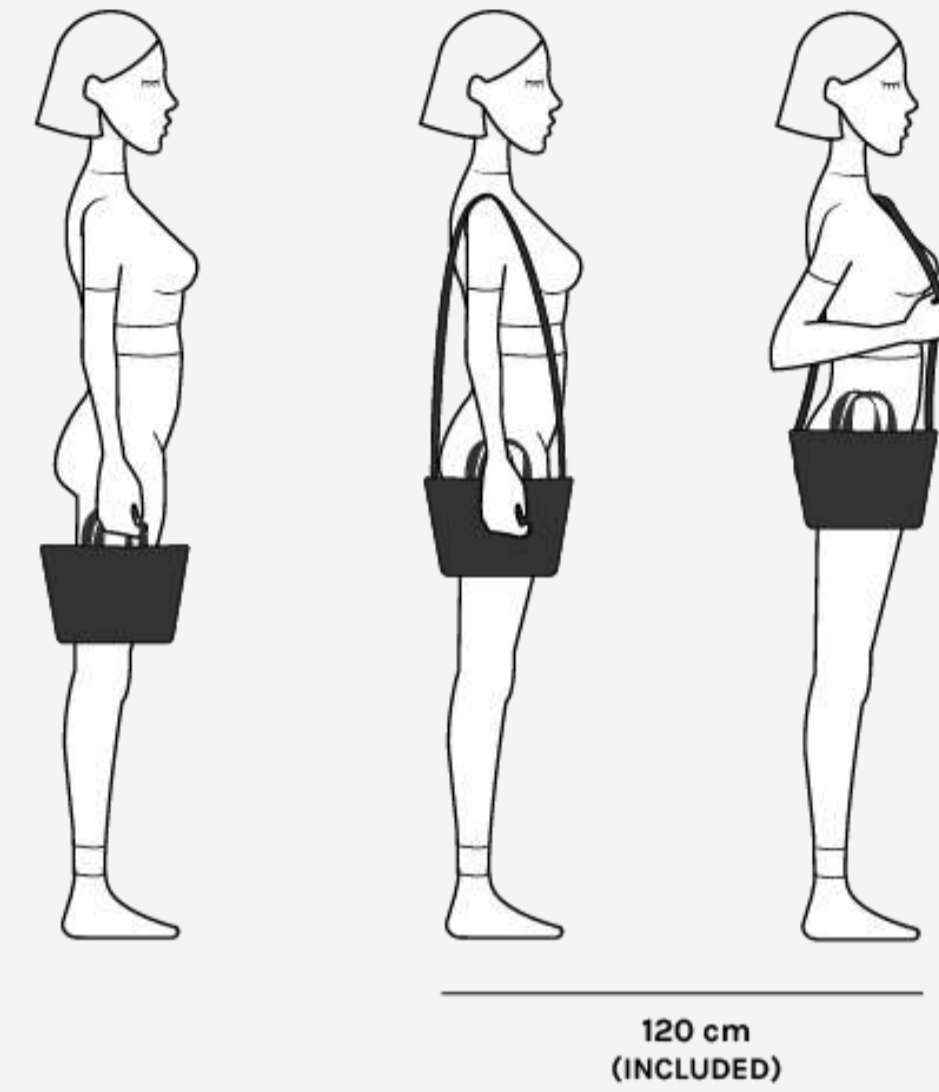

BEST SELLER

## JUANITA

SHOP

RETAIL PRICE: 219,95€

\*Sign in to your account to see your wholesale price



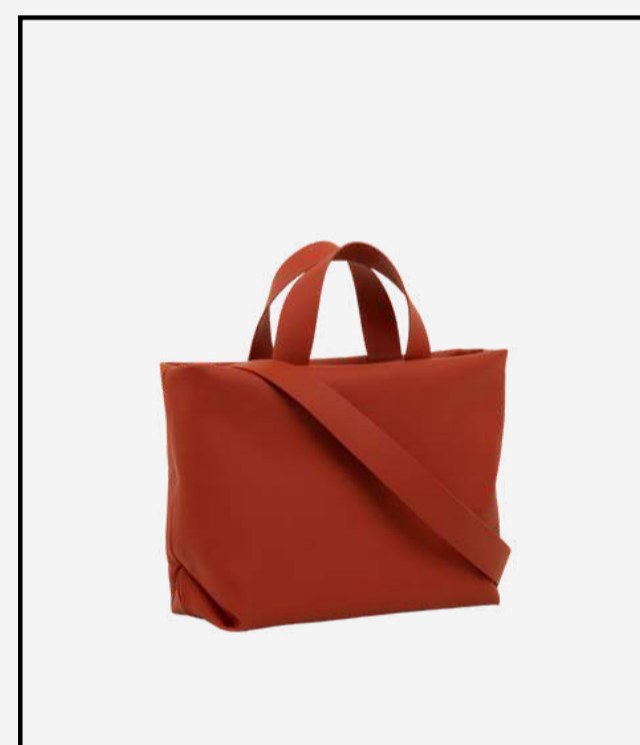
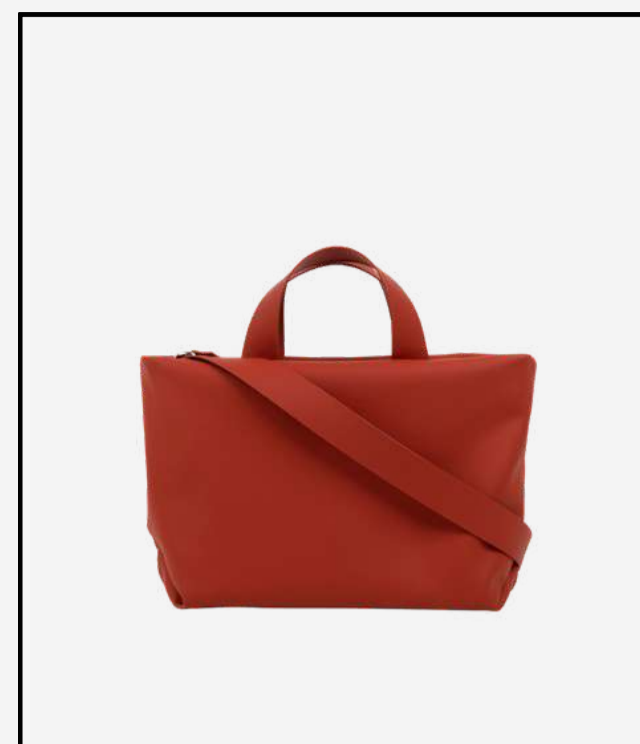
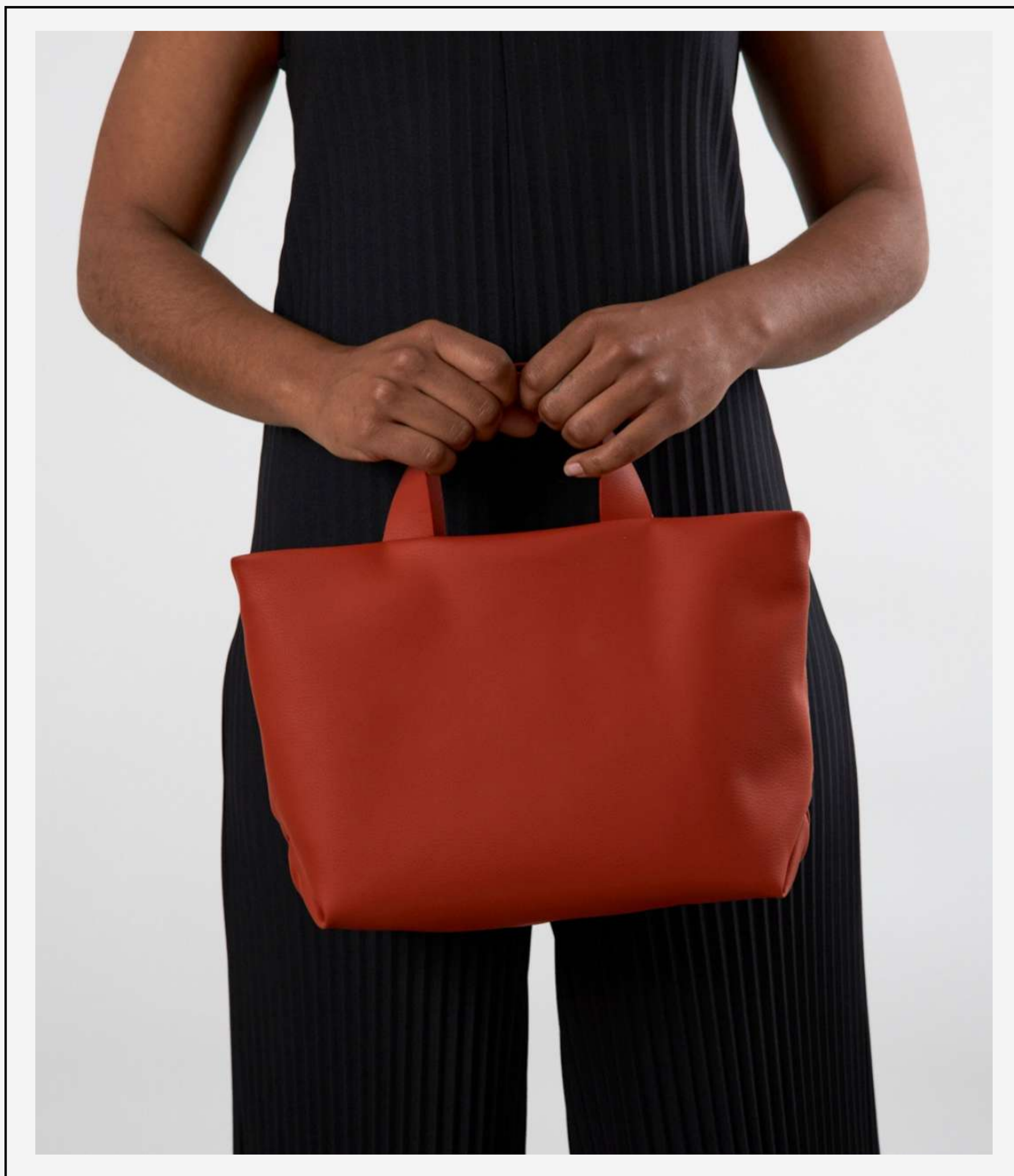

VEGAN

## JUANI

A bag that combines softness, strength and versatility in a design with minimalist lines. With a medium size, but with a large capacity, it is the perfect ally for any occasion!

DISCOVER



VEGAN

# JUANI

- Zip fastener YKK
- Outside made of vegan Biomaterial 100% silicone and plastic-free
- Inside made of very soft organic cotton canvas with GOT certificate
- Waterproof, very resistant to scratches and stains, hypoallergenic, odorless...
- Two integrated 30 cm handles also a strap of 100 cm included (interchangeable)
- Reinforced base to keep its shape
- Extra straps available: 60 cm, 70 cm, 80 cm, 100 cm, 120 cm or 140 cm

SHOP

EXTRAS

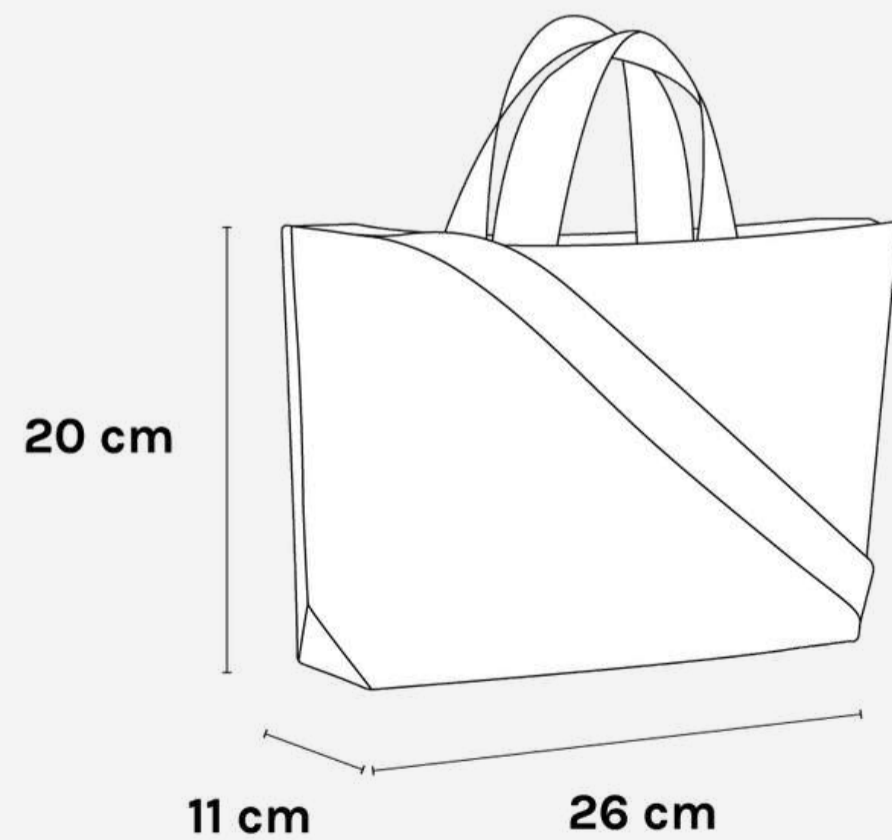

BLACK



OLIVE GREEN



YELLOW



SKY BLUE



LEMON CREAM



BRICK RED



FANCY GREY



MAROON



STONE GREY



MOSS BLUE





POSITIONS | \* The model is 1.70 m tall

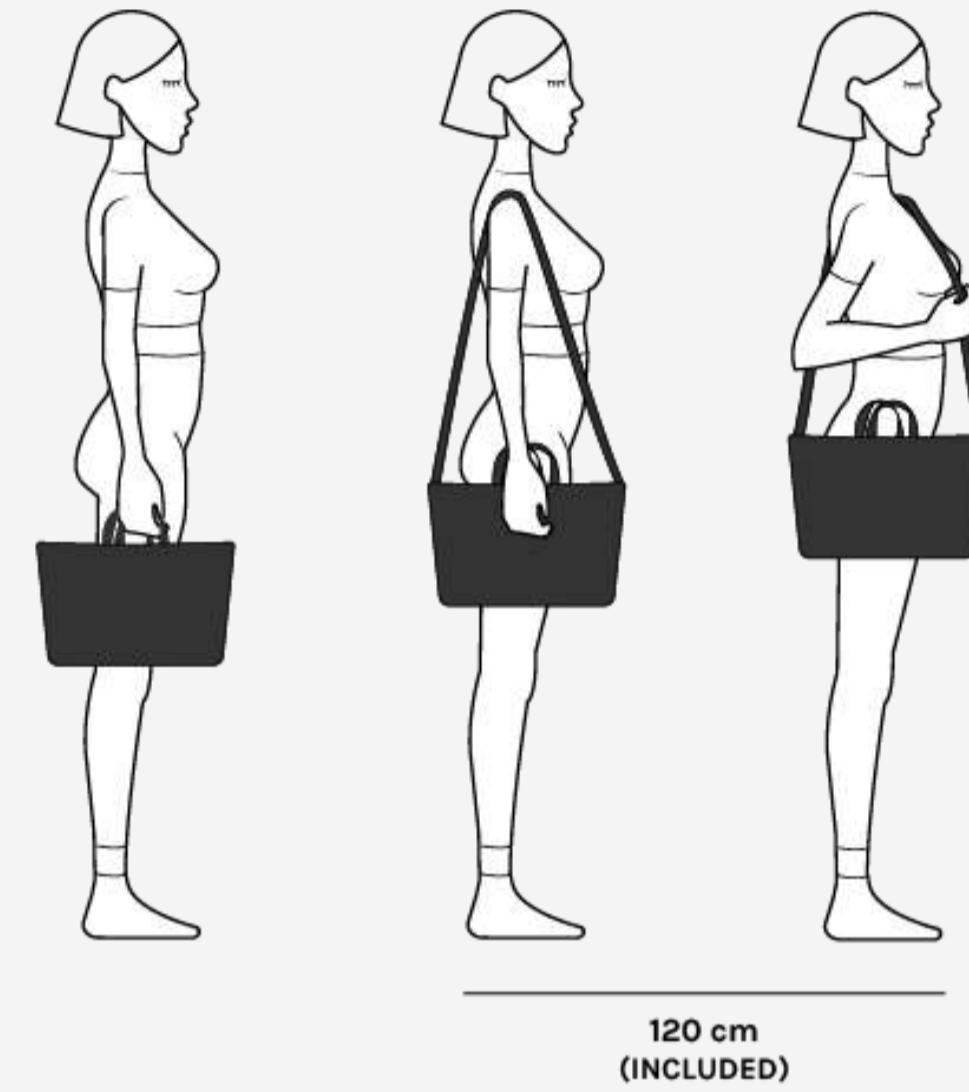

VEGAN

## JUANI

SHOP

RETAIL PRICE: 249,95€

\*Sign in to your account to see your wholesale price



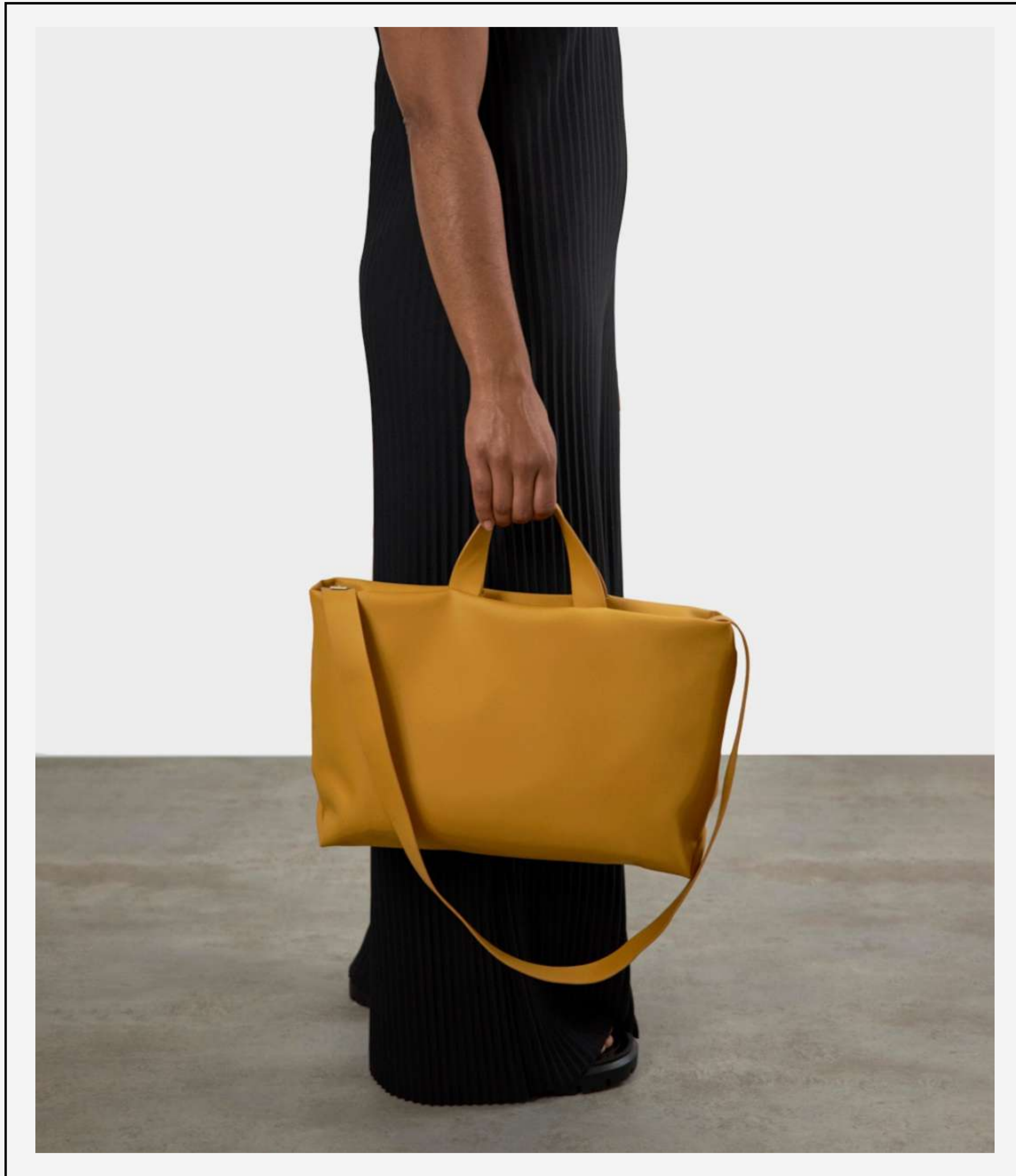

VEGAN

## JUANA

Juana, the maxi bag for those who are looking for that extra space. Soft, resistant and versatile with tons of capacity, perfect for the office and everyday life!

DISCOVER



VEGAN

# JUANA

- Zip fastener YKK
- Outside made of vegan Biomaterial 100% silicone and plastic-free
- Inside made of very soft organic cotton canvas with GOT certificate
- Waterproof, very resistant to scratches and stains, hypoallergenic, odorless...
- Two integrated 30 cm handles also a strap of 100 cm included (interchangeable)
- Reinforced base to keep its shape
- Extra straps available: 60 cm, 70 cm, 80 cm, 100 cm, 120 cm or 140 cm

SHOP

EXTRAS

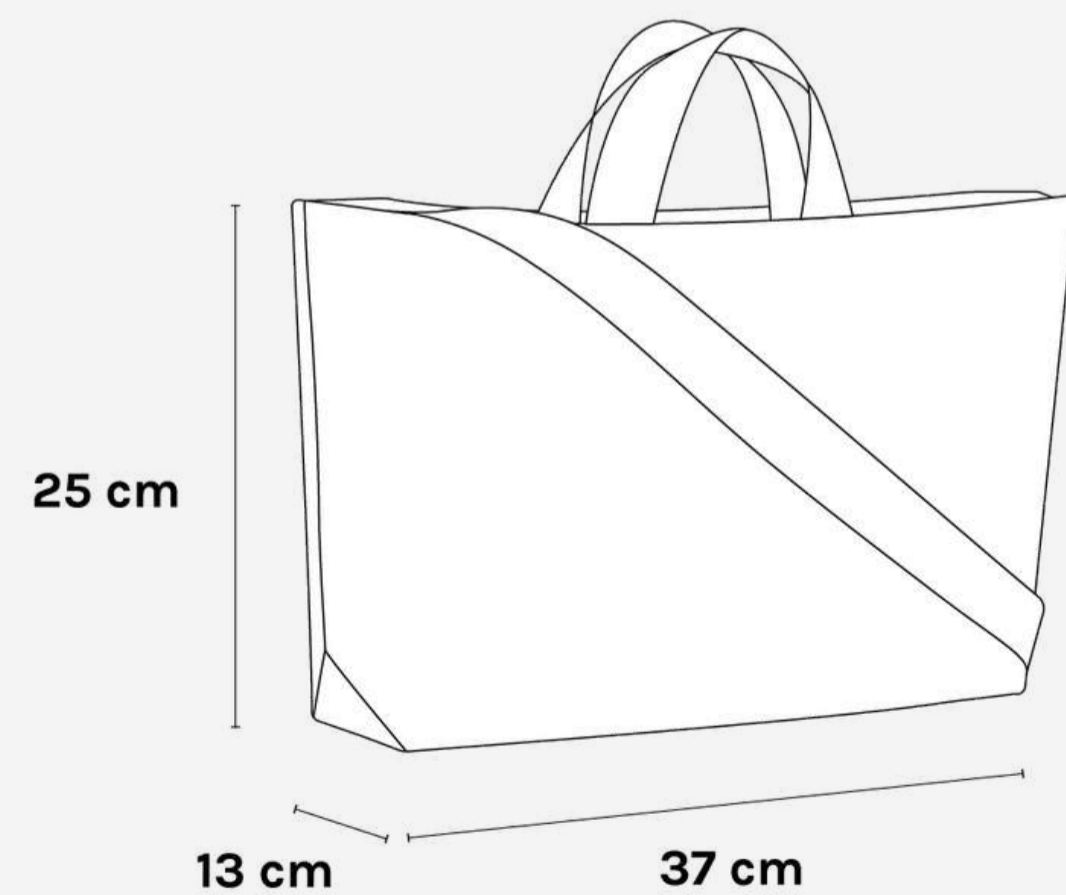

BLACK



OLIVE GREEN



YELLOW



SKY BLUE



LEMON CREAM



BRICK RED



FANCY GREY



MAROON



STONE GREY



MOSS BLUE





POSITIONS | \* The model is 1.70 m tall

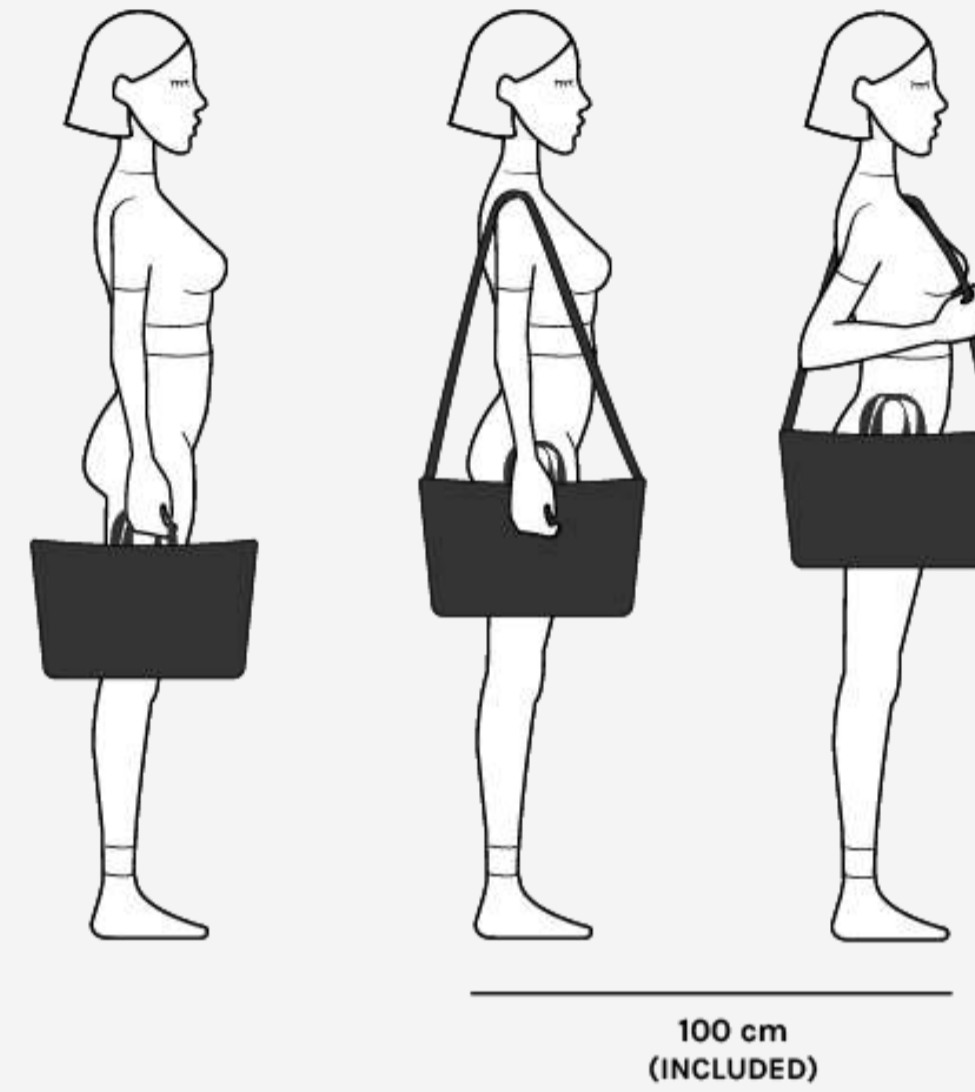

VEGAN

## JUANA

SHOP

RETAIL PRICE: 289,95€

\*Sign in to your account to see your wholesale price





VEGAN

## FERNANDITA

It's useful and comfy like no other one, and it's also very pleasing, soft, resistant and versatile. And the best part is that it keeps the pure and minimal design typical of Labienhecha.

DISCOVER



VEGAN

# FERNANDITA

- Flap with double magnetic fastener
- Outside made of vegan Biomaterial 100% silicone and plastic-free
- Inside made of very soft organic cotton canvas with GOT certificate
- Waterproof, very resistant to scratches and stains, hypoallergenic, odorless...
- Belt included
- Reinforced base to keep its shape
- Inside compartments for a great organization (central compartment with zip fastener)

SHOP

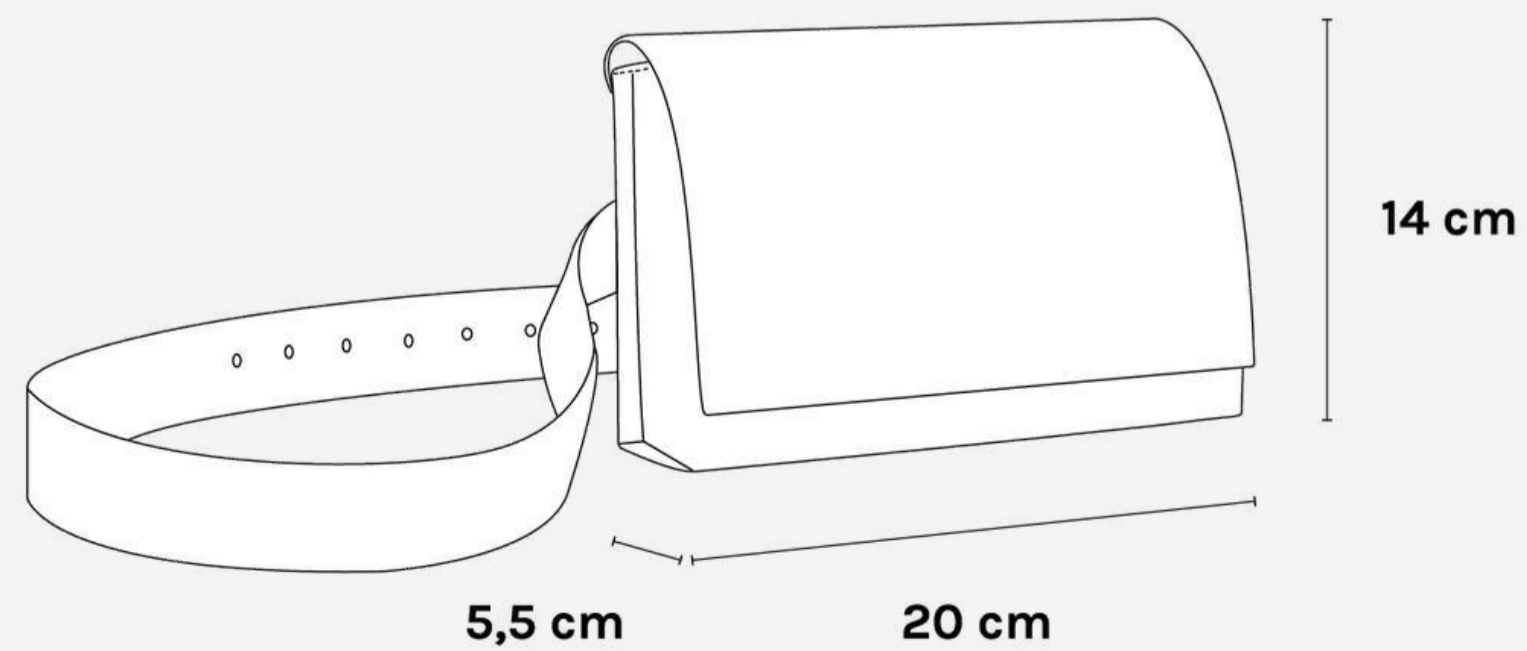

BLACK



OLIVE GREEN



YELLOW



SKY BLUE



LEMON CREAM



BRICK RED



FANCY GREY



MAROON



STONE GREY



MOSS BLUE





POSITIONS | \* The model is 1.70 m tall

---

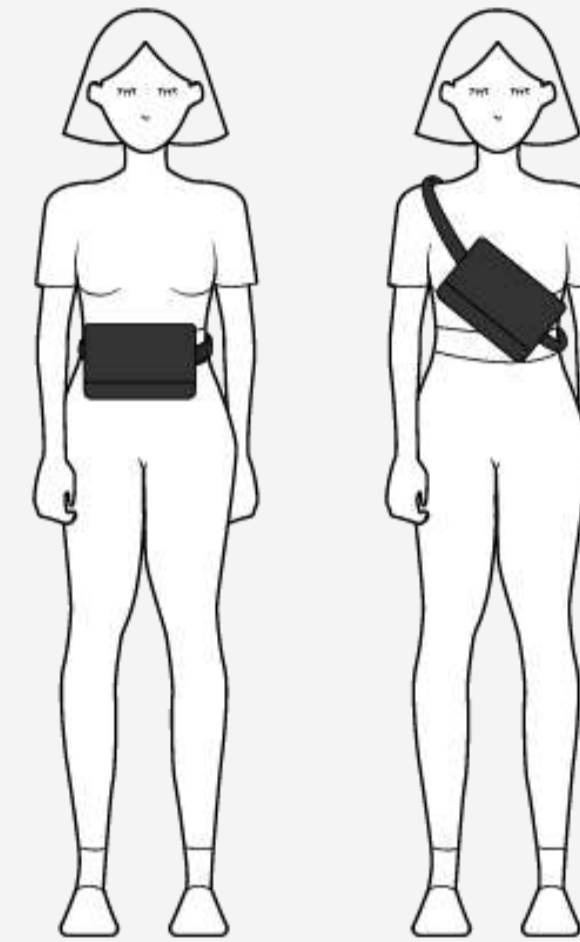

140 cm  
(INCLUDED)

VEGAN

## FERNANDITA

SHOP

RETAIL PRICE: 219,95€

\*Sign in to your account to see your wholesale price



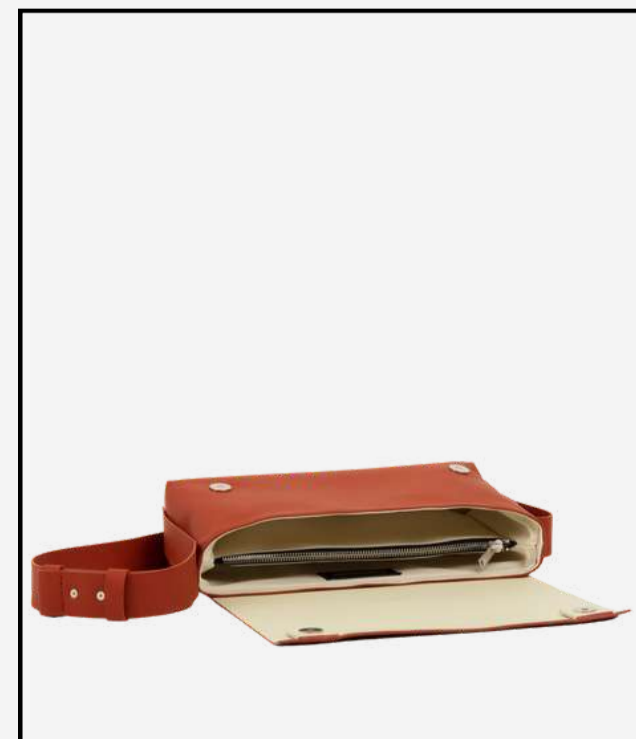
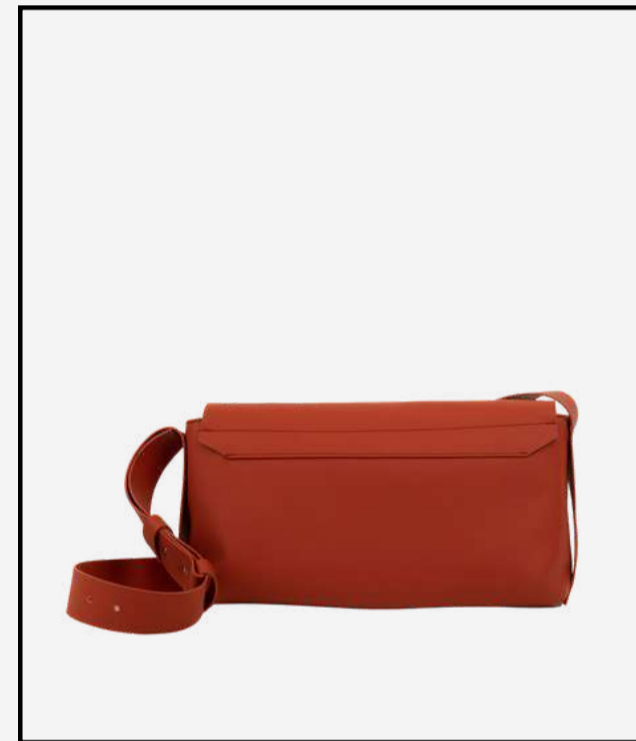
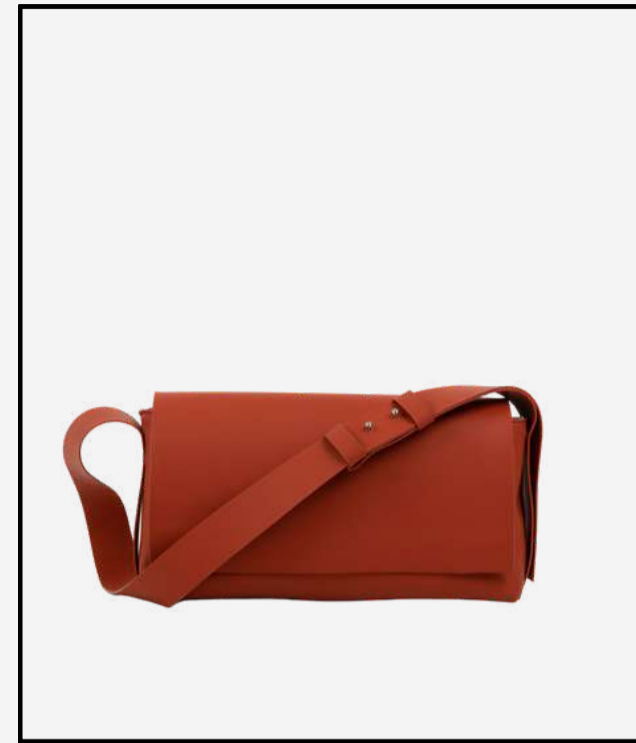
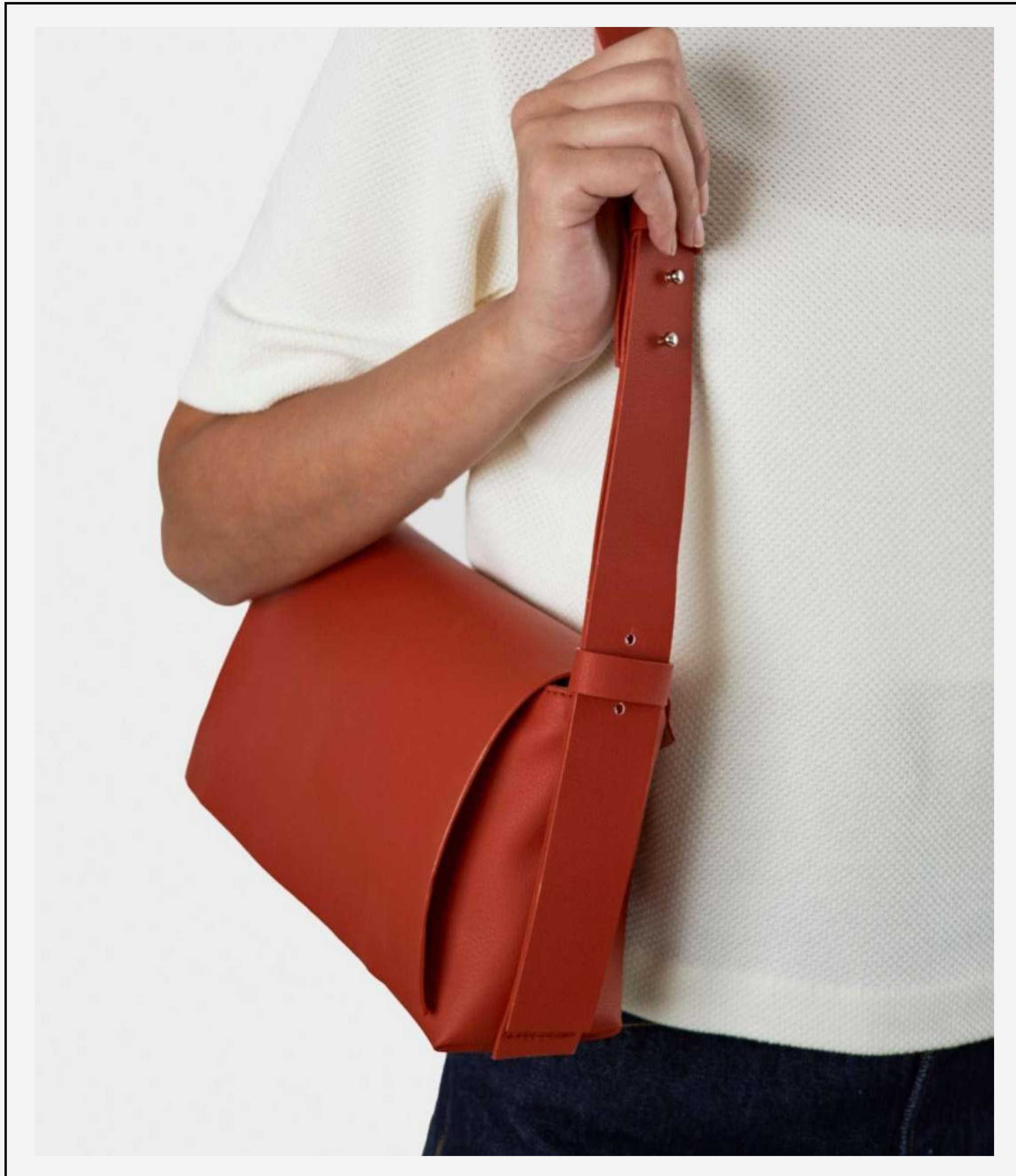

VEGAN

## FERNANDA

A baguette bag with flap and magnet closures. Like all our soft bags, the interior is lined with organic cotton and has many compartments - the perfect wardrobe essential!

DISCOVER



VEGAN

# FERNANDA

- Flap with double magnetic fastener
- Outside made of vegan Biomaterial 100% silicone and plastic-free
- Inside made of very soft organic cotton canvas with GOT certificate
- Waterproof, very resistant to scratches and stains, hypoallergenic, odorless...
- Adjustable strap
- Reinforced base to keep its shape
- Inside compartments for a great organization (central compartment with zip fastener)

SHOP

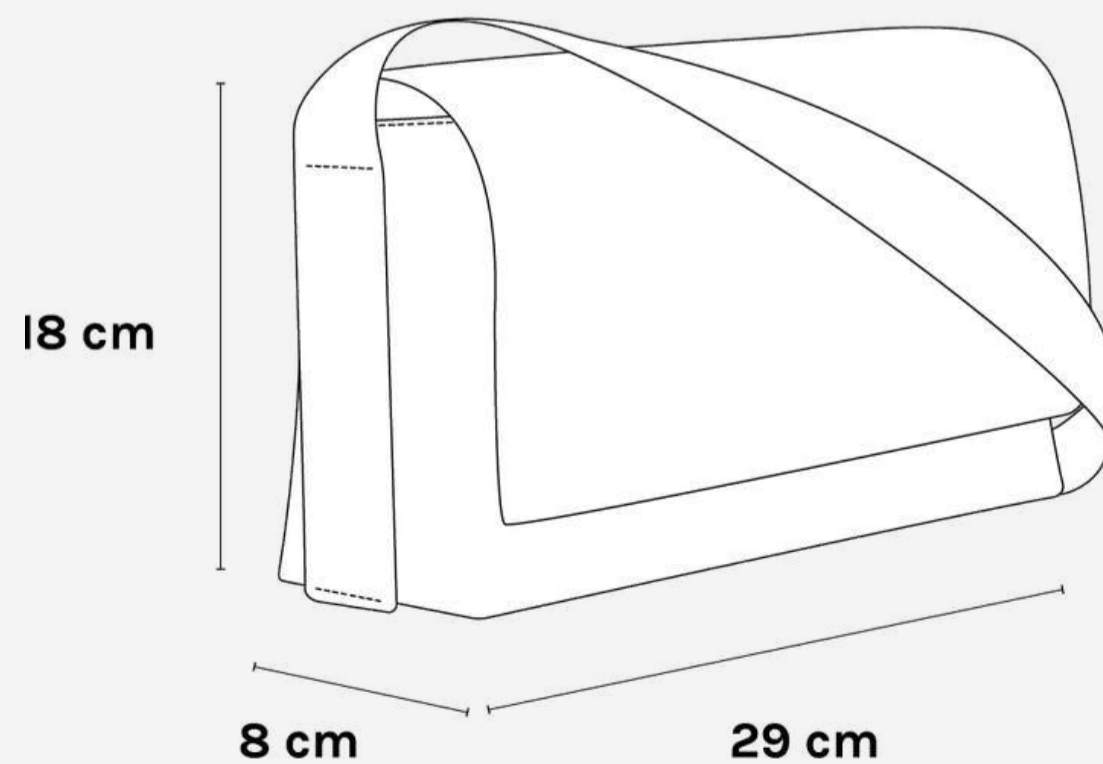

BLACK



OLIVE GREEN



YELLOW



SKY BLUE



LEMON CREAM

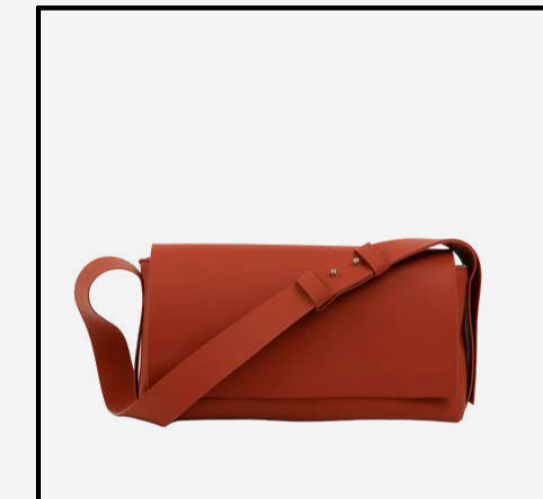

BRICK RED



FANCY GREY



MAROON



STONE GREY



MOSS BLUE





POSITIONS | \* The model is 1.70 m tall

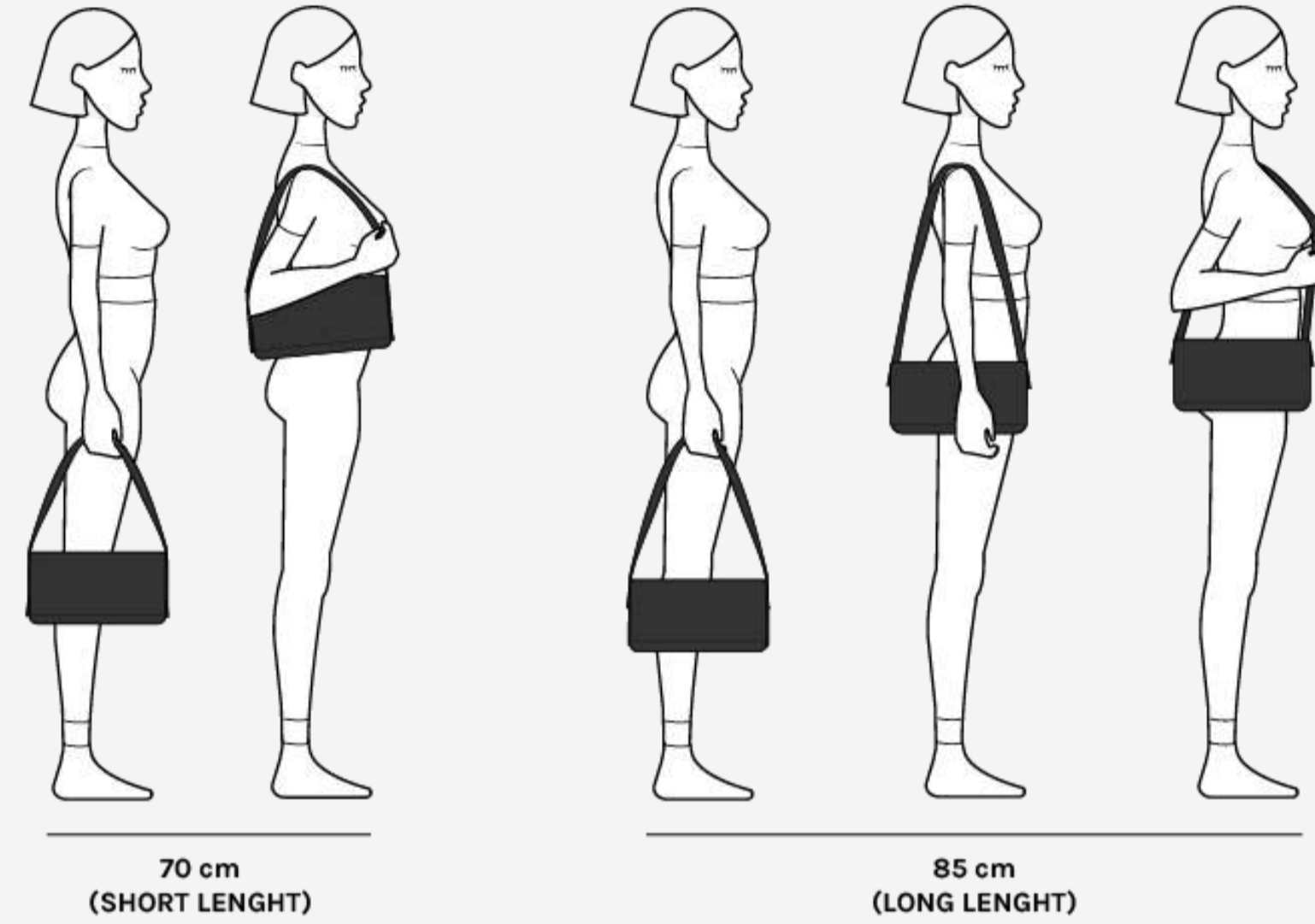

VEGAN

## FERNANDA

SHOP

RETAIL PRICE: 269,95€

\*Sign in to your account to see your wholesale price





NEW!

## ADELITA

Adelita is a versatile and comfortable bag thanks to its multi-position. 5 bags in 1! Adjustable handle with 5 positions. Small but with lots of capacity and extra light.

DISCOVER



NEW!

# ADELITA

- Zip fastener YKK
- Outside made of vegan Biomaterial 100% silicone and plastic-free
- Inside made of very soft organic cotton canvas with GOT certificate
- Waterproof, very resistant to scratches and stains, hypoallergenic, odorless...
- Adjustable strap (5 positions). Strap length: Short position 41 cm - Long position 125 cm
- Interior pocket
- Measurements: (Width) 24 cm x (Height) 13 cm x (Depth) 7 cm

SHOP

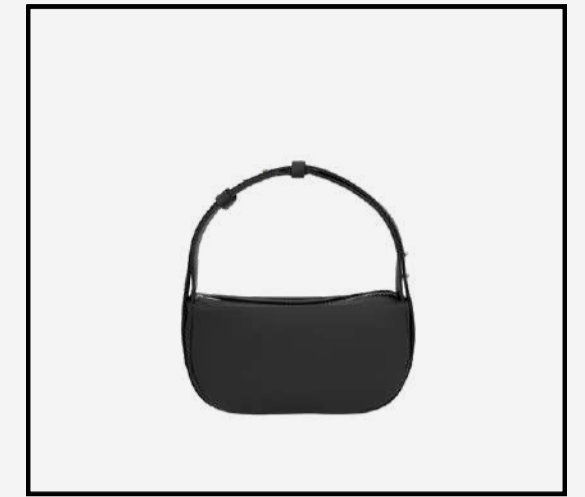

BLACK



OLIVE GREEN



YELLOW



SKY BLUE



LEMON CREAM



BRICK RED



FANCY GREY



MAROON



STONE GREY



MOSS BLUE





POSITIONS | \* The model is 1.70 m tall

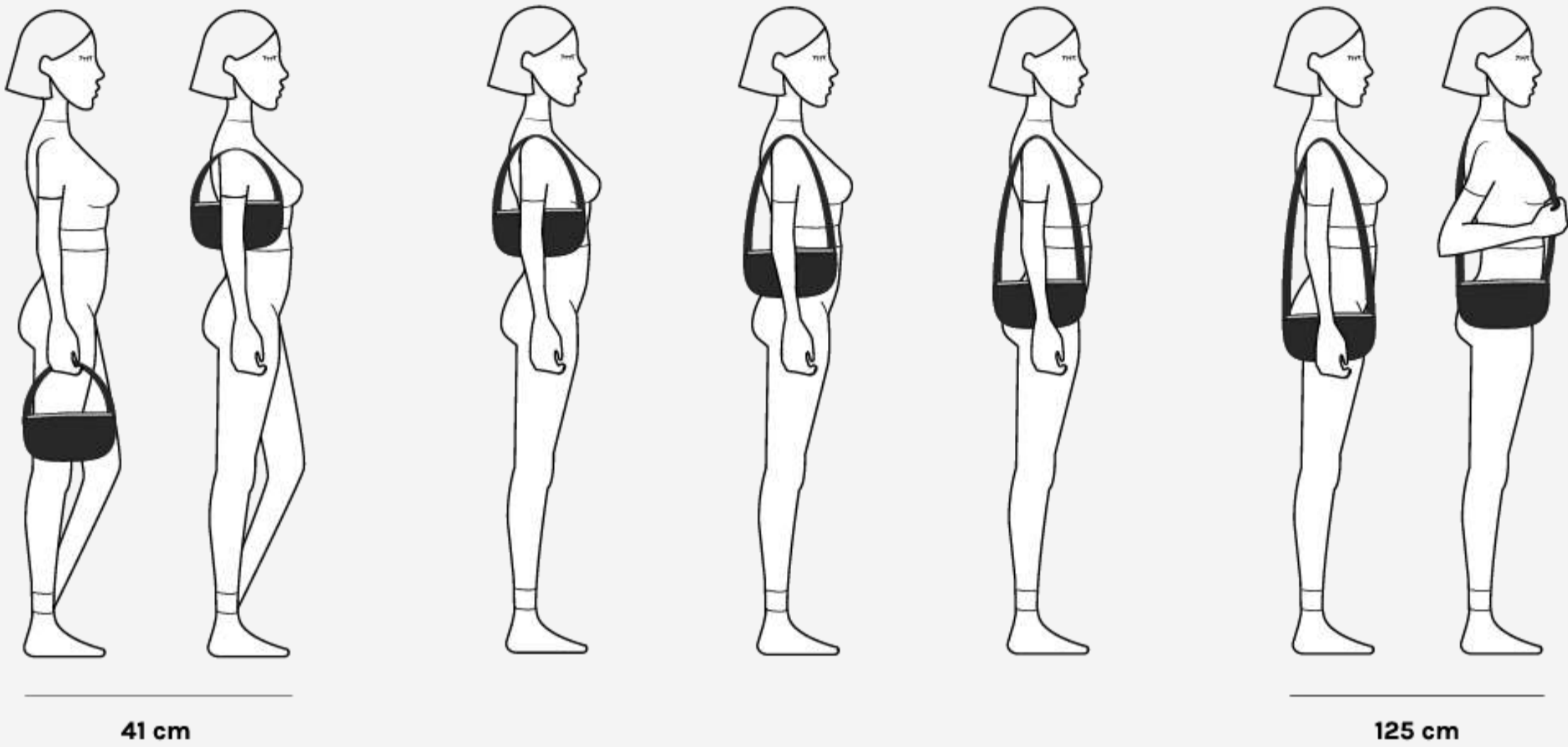

NEW!

# ADELITA

SHOP

RETAIL PRICE: 249,95€

\*Sign in to your account to see your wholesale price



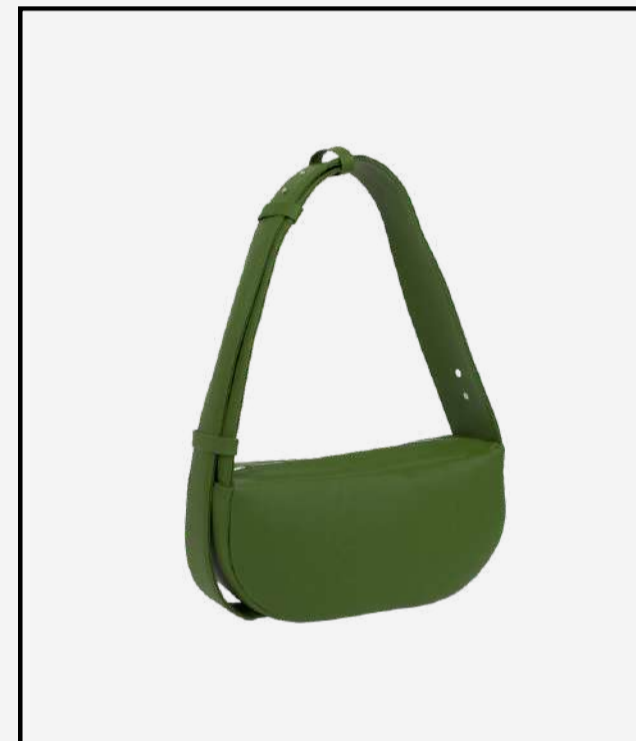

NEW!

## ADELINA

It's like having 3 or 4 bags in 1! It has an Adjustable strap with 4 positions. It has an amazing capacity. Super functional, very light.

DISCOVER



NEW!

# ADELINA

- Zip fastener YKK
- Outside made of vegan Biomaterial 100% silicone and plastic-free
- Inside made of very soft organic cotton canvas with GOT certificate
- Waterproof, very resistant to scratches and stains, hypoallergenic, odorless...
- Adjustable strap (5 positions). Largo del asa: Short position 68 cm - Long position 150 cm
- Interior pocket
- Measurements: (Width) 30 cm x (Height) 15 cm x (Depth) 9 cm

SHOP



BLACK



OLIVE GREEN



YELLOW



SKY BLUE



LEMON CREAM



BRICK RED



FANCY GREY



MAROON

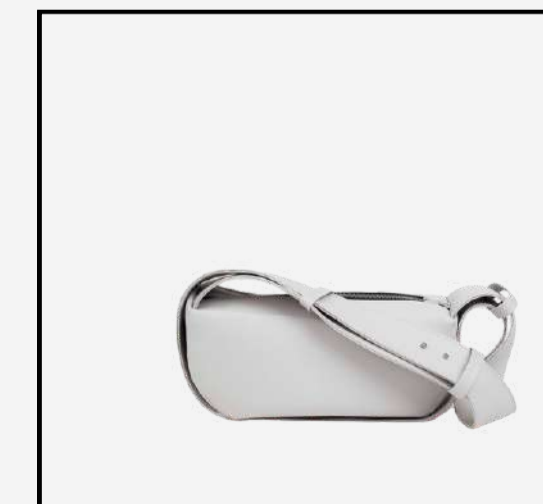

STONE GREY

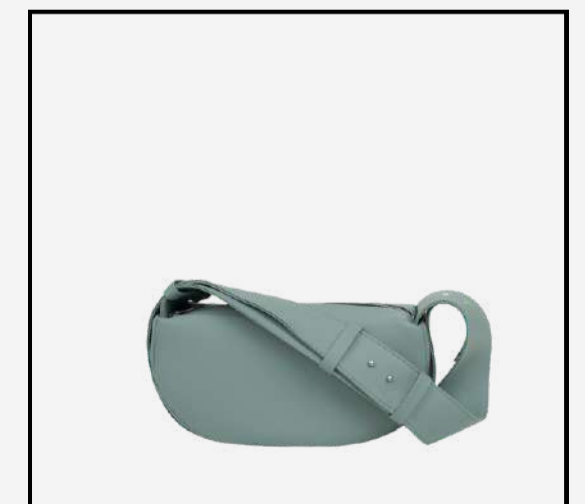

MOSS BLUE





POSITIONS | \* The model is 1.70 m tall

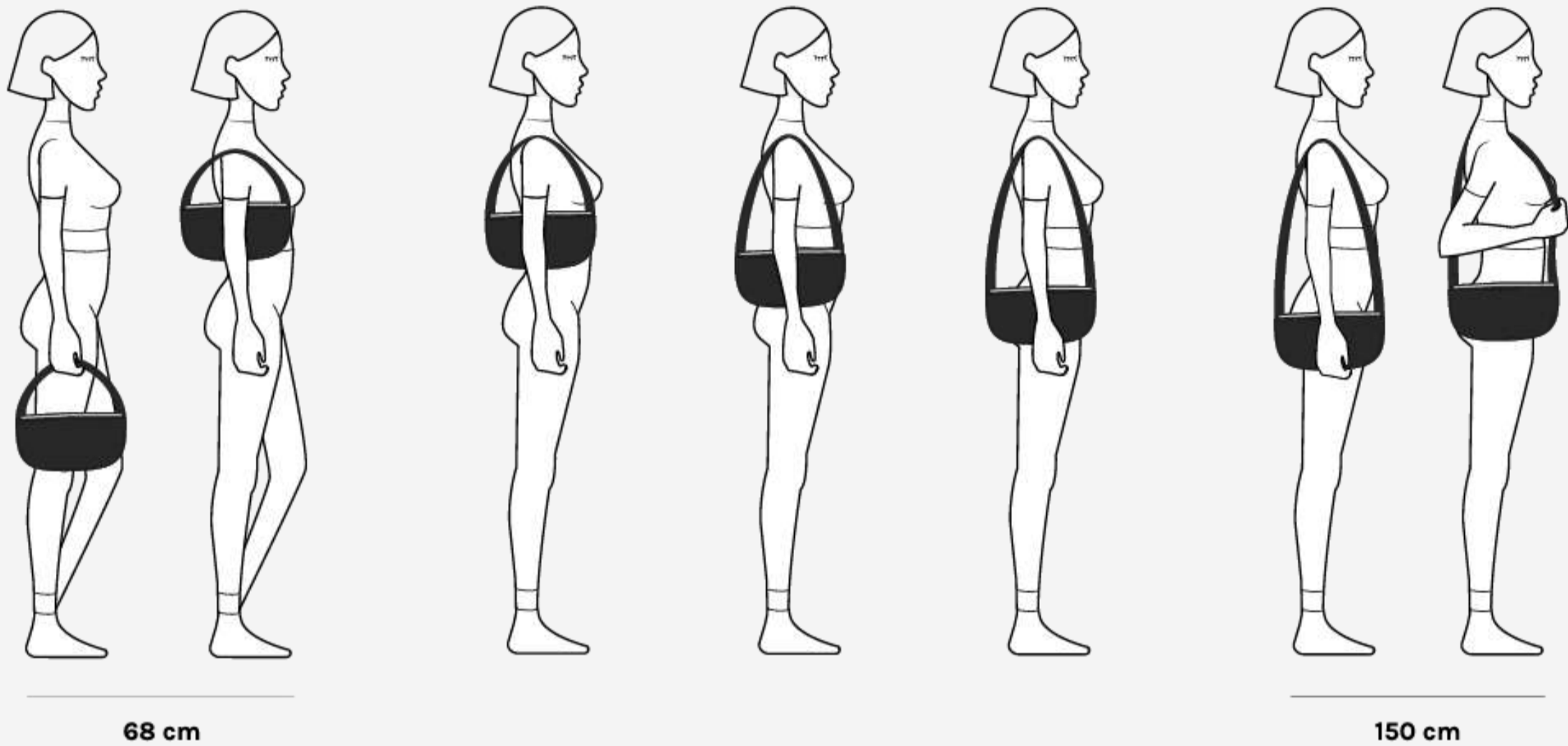

NEW!

# ADELINA

SHOP

RETAIL PRICE: 279,95€

\*Sign in to your account to see your wholesale price



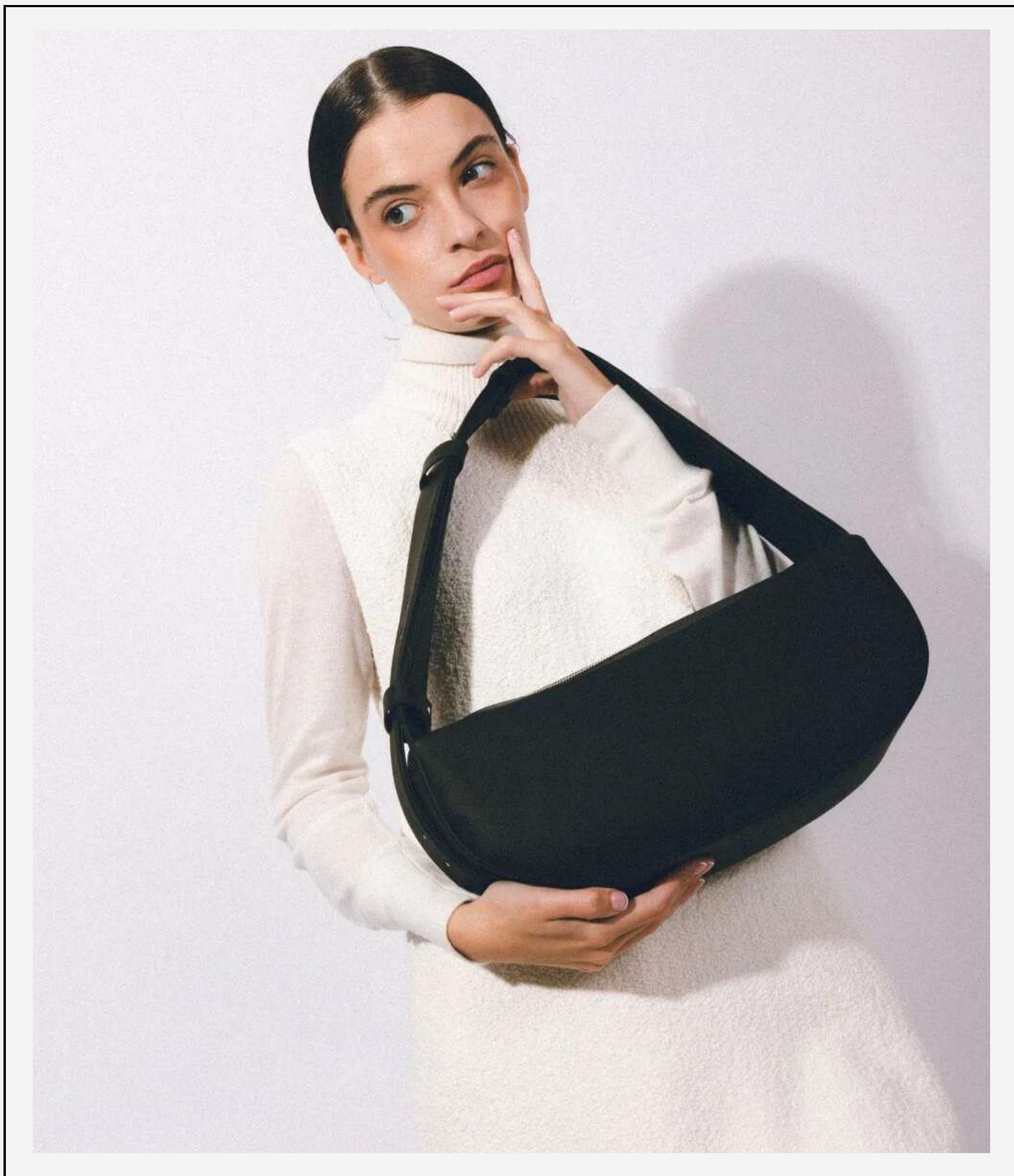

NEW!

## ADELA

Multi-position maxi bag - it's like having 3 or 4 bags in 1! It has an Adjustable strap with 4 positions. The most capacious bag in this family of three. Fits everything!

DISCOVER



NEW!

# ADELA

- Zip fastener YKK
- Outside made of vegan Biomaterial 100% silicone and plastic-free
- Inside made of very soft organic cotton canvas with GOT certificate
- Waterproof, very resistant to scratches and stains, hypoallergenic, odorless...
- Adjustable strap (5 posiciones). Strap length: Short position 68 cm - Long position 150 cm
- Interior pocket
- Measurements: (Width) 35 cm x (Height) 15 cm x (Depth) 9 cm

SHOP



BLACK



OLIVE GREEN



YELLOW



SKY BLUE



LEMON CREAM



BRICK RED



FANCY GREY



MAROON



STONE GREY



MOSS BLUE





POSITIONS | \* The model is 1.70 m tall

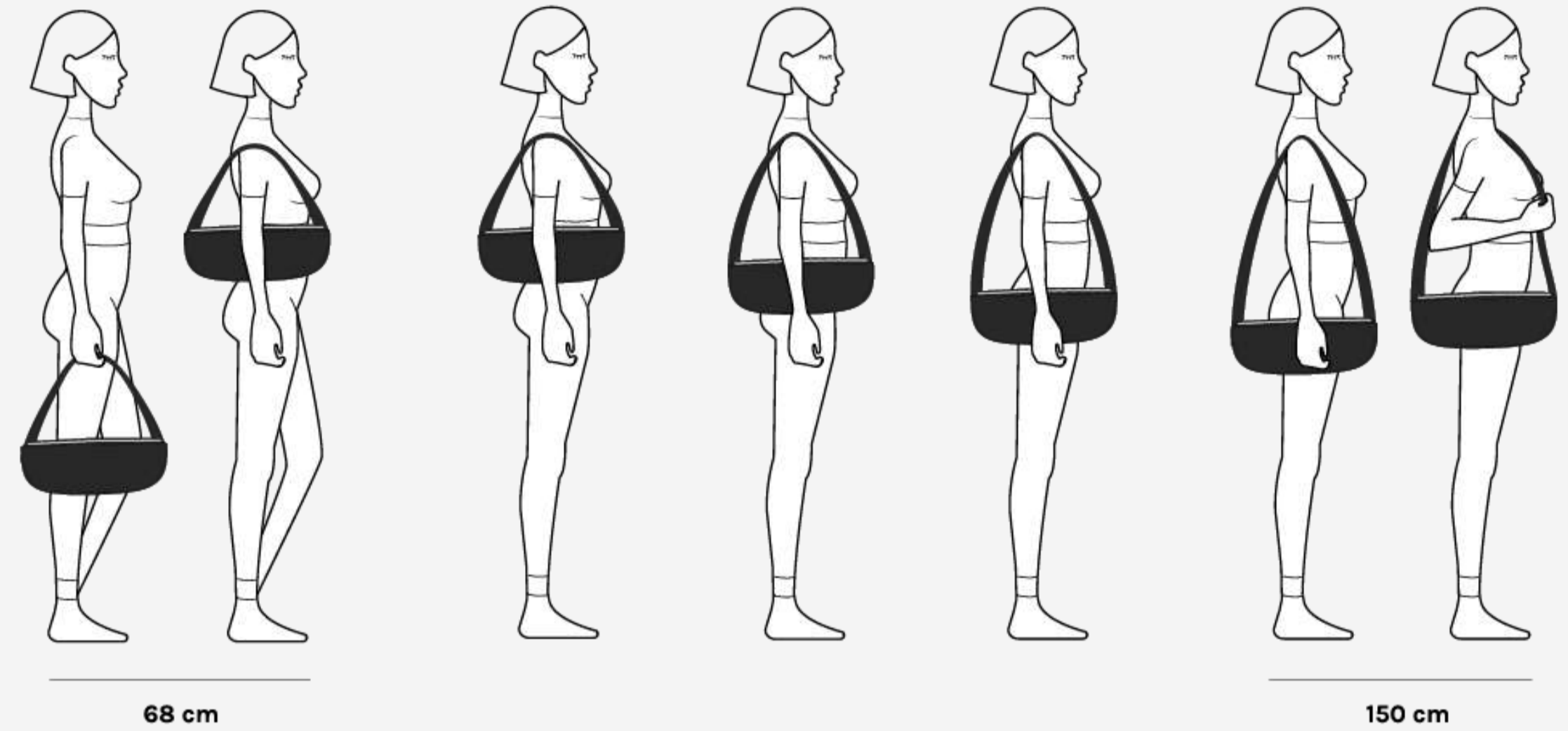

NEW!

## ADELA

SHOP

RETAIL PRICE: 289,95€

\*Sign in to your account to see your wholesale price





VEGAN

## EXTRAS

To spice up our bienhechas. Add straps to interchange and mix colours, and make several bags in one.

DISCOVER



EXTRAS

# ÁNGELAS STRAPS

- Available sizes: 60 cm, 70 cm, 80 cm, 100 cm, 120 cm and 140 cm
- Strap with carabiner system. You can add all the extra straps that you want to make matches with your bienhechas bags
- Compatible with Doña Ángela, Ángela, Angelines or Angelita (also if you prefer your Juanas with a thinner strap)
- Width 1,5 cm

SHOP

RETAIL PRICE: 29,95€

\*Sign in to your account to see your wholesale price



BLACK



OLIVE GREEN



YELLOW



SKY BLUE



LEMON CREAM

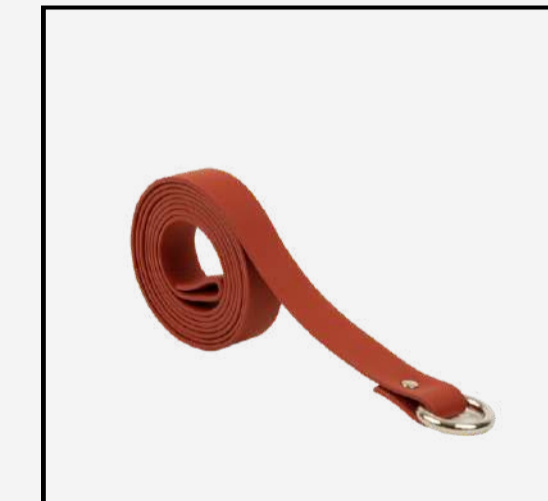

BRICK RED



FANCY GREY



MAROON



STONE GREY



MOSS BLUE



EXTRAS

## JUANAS STRAPS

- Available sizes: 60 cm, 70 cm, 80 cm, 100 cm, 120 cm and 140 cm
- Strap with carabiner system. You can add all the extra straps that you want to make matches with your bienhechas bags
- Compatible with Juanita, Juani and Juana (also if you prefer your Ángelas with a thicker strap)
- Width 3 cm

SHOP

RETAIL PRICE: 39,95€

\*Sign in to your account to see your wholesale price



BLACK



OLIVE GREEN



YELLOW



SKY BLUE



LEMON CREAM



BRICK RED

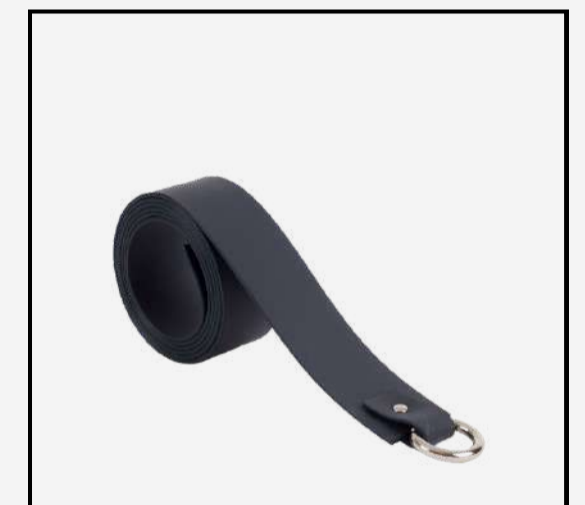

FANCY GREY



MAROON



STONE GREY



MOSS BLUE



TOP 10

# BEST-SELLERS

The bienhechas that have been conquering hearts for a long time.

Some of them have been with us since minute one... and we keep on producing them non-stop.

SHOP



PAQUITA DISCOVER →



RAMONA DISCOVER →



PEPE DISCOVER →



SOFÍA (HIJA) DISCOVER →



ANGELINA DISCOVER →



SOFÍA (MADRE) DISCOVER →



ENCARNITA (LM) DISCOVER →



BERNARDITA DISCOVER →



BERNARDA DISCOVER →



JOSEFA DISCOVER →





WHO ARE WE?

## ABOUT LABIENHECHA

We are a team of women making (well-made) things in a workshop in Malaga and working along three lines of action: creating a quality, local and ecological product; raising awareness about sustainability and, on the other hand, empowering the female role in entrepreneurship and in life in general.

What makes us most proud of our project?

- 100% handmade, local and ecological product.
- Made in Spain, in our workshop, in a responsible and ethical way.
- Top quality sustainable materials, always certified
- We empower female entrepreneurship





HOW DO WE DO IT?

## OUR WORKSHOP DISCOVER

Everything we make is produced in our own workshop, with our own hands - in an artisan and honest way - trying to damage our environment as little as possible, striving to keep tradition alive and, of course, with tons and tons of love.

At Labienhecha we take care of everything. When we say everything, we mean EVERYTHING. From the idea to the design, the making of the bag, the marketing, the commercialisation, administration... Everything!



HOW DO WE DO IT?

## SUSTAINABLE PRODUCTION

We believe that nothing is 100% sustainable, but that with small acts and our decisions as a brand, we can reduce our negative impact and foster a culture around sustainability.

We consider all perspectives on sustainability (economic, environmental and/or social and labour). Therefore, we want to advance in our own R&D, working with other sustainable and certified materials, offering other alternatives, expanding our knowledge, improving our resources to achieve better results, optimising our workshop and always aiming to damage our planet as little as possible.





HOW DO WE DO IT?

## OUR MATERIALS

At Labienhecha we strive to research materials that meet our high requirements in terms of sustainability. That is why we only work with eco-friendly, durable, quality materials that are environmentally friendly and have the least negative impact. These are the main materials we work with:



VEGAN BIOMATERIAL



RECYCLED LEATHER



ORGANIC COTTON



# HELP

---

NEW CLIENT REGISTRATION →

CLIENT ACCESS →

B2B SHOPPING PORTAL →

QUICK ORDER →

REQUEST DEMO →

PROMOTIONS →

FAQS →

CLIENT AREA

ORDER FORM





WE DON'T MAKE PERFECT THINGS,  
WE JUST MAKE WELL-MADE THINGS

---

## Labienhecha

### CONTACTO

C/ Croacia, 19. CP: 29004 - Málaga, España  
sales@labienhecha.com

### SOCIAL & WEB

FB: Labienhecha  
IG: @soylabienhecha  
WEB: labienhecha.com

### INFO

We design and create bags and other beloved goods using only certified eco-materials. Everything is made on a slow burn in a small workshop in Málaga by a super team of women that love what they do.