

# INSTALLATION INSTRUCTIONS

## CARRIER BEARING/DRIVELINE COMBO - TURBO S



### TOOLS REQUIRED

- 8, 10 Deep Socket
- 1/8", M6 Allen
- T40 Wrench
- Rubber Mallet
- Jack Stands
- 8,10,13,15,17 Socket
- 3/4" Drill Bit
- Ratchet Strap
- Floor Jack

#### STEP 1

Remove the clutch cover and hose.



#### STEP 2

Remove 2x 13mm drivers side engine mount nuts.

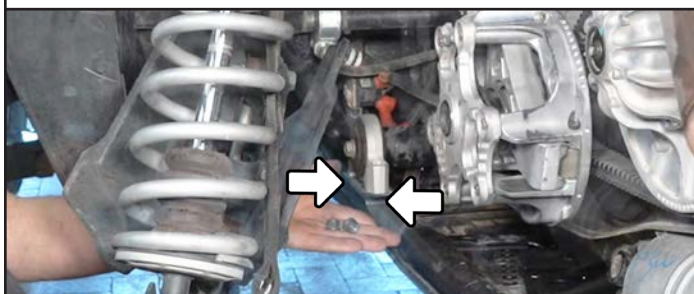

#### STEP 3

Raise the engine off the frame 1-2 inches & secure with a ratchet strap.



#### STEP 4

Raise the rear wheels off the ground & secure with jack stands.



#### STEP 5

Remove the skid plates front to rear.

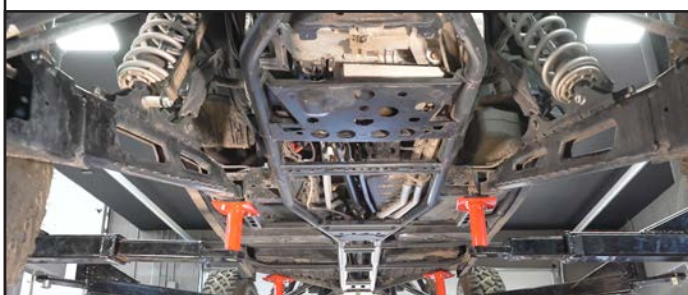

#### STEP 6

Remove 4x 6mm rear driveline flange bolts.



#### STEP 7

Remove 2x T40 safety hoop screws and remove safety hoop. Retain for re installation later.



# INSTALLATION INSTRUCTIONS

## CARRIER BEARING/DRIVELINE COMBO - TURBO S



### STEP 8

Remove the rear half of the driveline rearward out of the car.



### STEP 9

Remove 1x 10mm scatter guard & 1x 10mm screw from the inter-cooler line bracket.

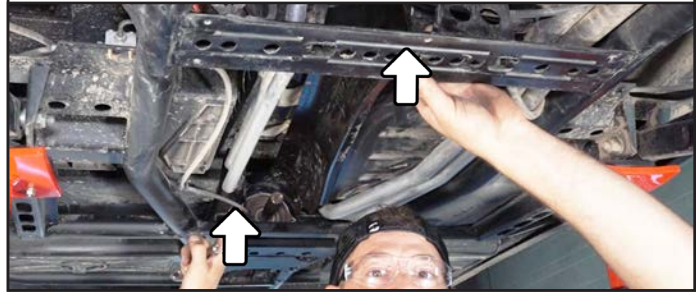

### STEP 10

Remove 2x 15mm factory carrier bearing bolts.

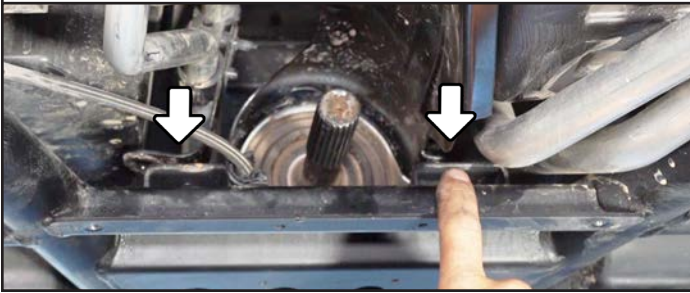

### STEP 11

Remove scatter guard from car & set aside.



### STEP 12

Remove roll pin from front half of the driveline where it meets the front differential.



### STEP 13

Remove the factory front half of the driveline out of the middle of the car.



### STEP 14

Drill  $\frac{3}{4}$ " zerk fitting access hole in the scatter guard to allow access for greasing.



### STEP 15

Re-insert modified factory scatter guard into the car & re install 2x scatter guard front bolts with washers.



# INSTALLATION INSTRUCTIONS

## CARRIER BEARING/DRIVELINE COMBO - TURBO S

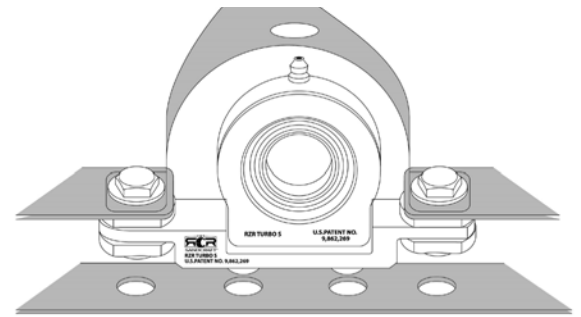

**COMPLETE INSTALLATION**

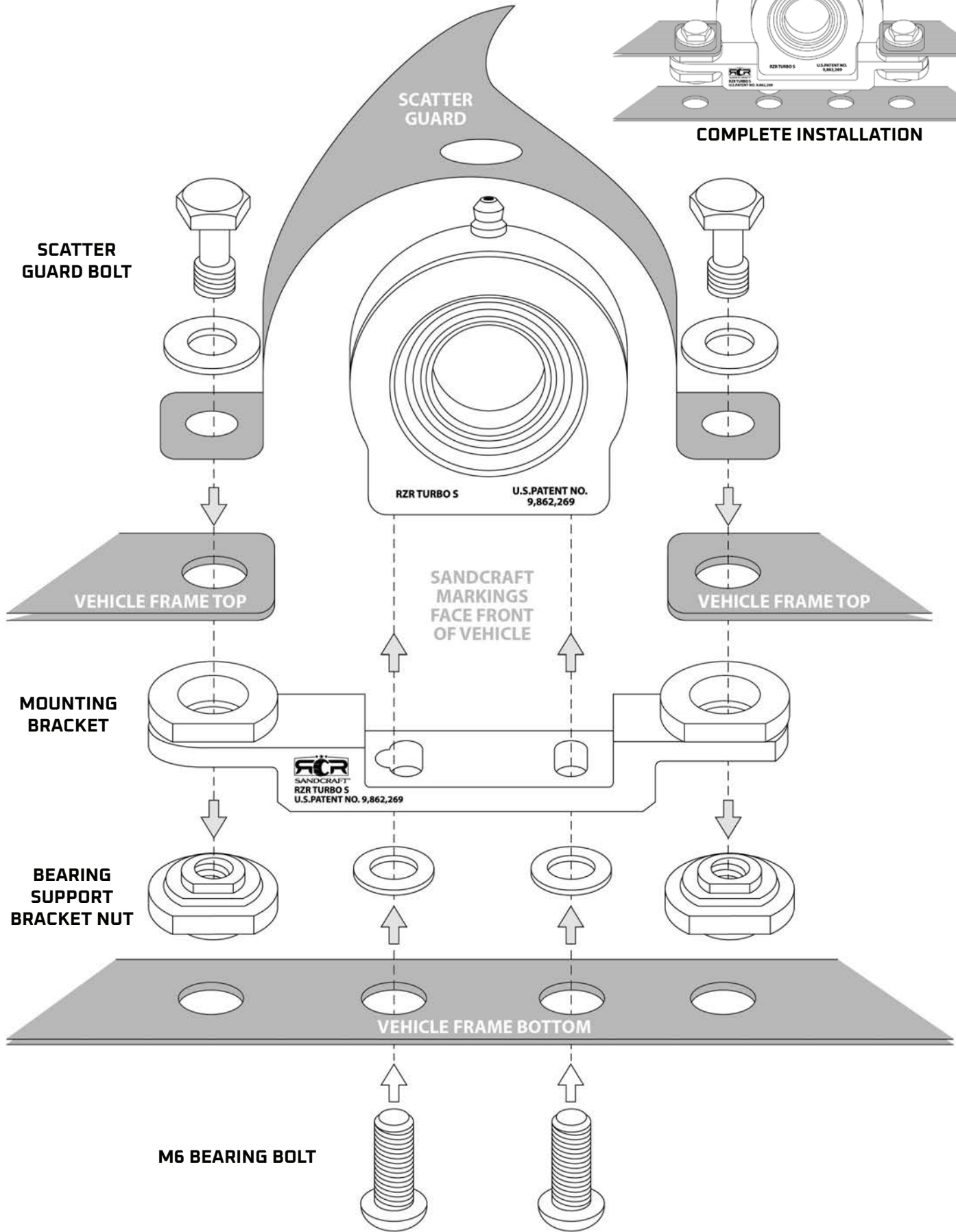

# INSTALLATION INSTRUCTIONS

## CARRIER BEARING/DRIVELINE COMBO - TURBO S



### STEP 16

Install & tighten 1x 10mm inter-cooler line bracket bolt.



### STEP 17

Insert the bearing support bracket nut in the outer frame holes with the dots facing forward. The dots remain forward facing in final installation.



### STEP 18

Insert the bearing support bracket into the frame drivers' side first, then drop the passenger side in.



### STEP 19

Use packaging foam to lift the bearing support bracket up from underneath. This presses the grommet bushings up against the factory weld nuts & holds them in place for tightening.

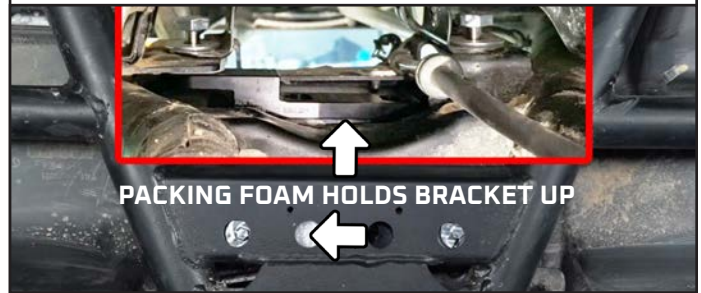

### STEP 20

Use an 8mm socket to push up on the bottom of the driver's side support bracket nut and lift it keeping the dot facing forward, then tighten the bolt from the top down. Do not rotate the support bracket nuts. Repeat this step for the passenger's side. Torque to 12 Ft-lbs.



### STEP 21

At this point, grease the carrier bearing. If you plan on installing the optional grease whip, you will install this once the carrier bearing is in the vehicle.



### STEP 22

Insert front driveline through the middle of the vehicle and slide to front.



### STEP 23

Connect front driveline to differential spline shaft making sure to align the spline bolt holes.



# INSTALLATION INSTRUCTIONS

## CARRIER BEARING/DRIVELINE COMBO - TURBO S



### STEP 24

Install the 5/16" differential spline bolt & nut. This is an all metal lock nut, do not over tighten.



### STEP 25

Loosen the 2x 1/8" Allen set screws, apply blue Loctite to the threads and torque to 8 Ft-lbs.



### STEP 26

Install 2x M6 bolts through the frame into the carrier bearing base plate (torque to 12 Ft-lbs). The Washers go inside the frame, the bolt captures the washer then tightens to the plate.



### STEP 27

Install Sandcraft RCR rear driveline in through the rear of the vehicle, carefully align spline and insert.



### STEP 28

Install the 4 M6 Allen bolts into the 4 bolt flange & tighten to 18 Ft-lbs.



### STEP 29

Re install factory safety hoop using existing hardware. Torque to 8 Ft-lbs.



### STEP 30

Double check all connections, test rotate the driveline then re install the skid plates.



### STEP 31

Lower the vehicle to the ground.



# INSTALLATION INSTRUCTIONS

## CARRIER BEARING/DRIVELINE COMBO - TURBO S



### STEP 32

Lower engine back onto frame, carefully align the two engine mount bolts so they slip back into the frame holes.



### STEP 33

Re install 2x 13mm engine mount nuts. Torque to 18 Ft-lbs.



### STEP 34

Re install clutch cover and hose.

