

WARNING: Bikes or rack falling in road can cause serious accidents resulting in bodily injury—do not use rack on any vehicle on which it can not be properly mounted as described in this instruction sheet.

- Rack should only be used on vehicles with 1 1/4" or 2" receiver hitches.
- **NEVER** use on trailers or front of vehicles.
- Bikes must be tied to rack using tie-downs, or additional straps if necessary.
- Check periodically during use that all bolts and pins are tight, and that rack and bicycles are secure.
- Never carry more than 2 bikes (**max capacity 70 LB/ 35 LB per bike**) - no tandems, mopeds, or recumbents. Car tail lights must remain visible.
- Drive conservatively, especially over bumps. Never use off-road.
- Do not use if any part of the rack is damaged, worn, or missing. Contact R. A. Allen Co., Inc. for replacement

CAUTION: Use Allen ZN520 only in accordance with local motor vehicle and traffic regulations.

- Install rack and load bicycles only at a safe distance away from moving traffic.
- Make sure that all of rack and bicycles are kept at a safe distance from road and hot exhaust.
- Only operate vehicle with rack in an upright, locked position.
- Bicycles should never extend beyond sides of vehicle.
- Remove rack from car, or fold carry arms down when not in use.

A. PARTS:

ZN520 BOX SHOULD CONTAIN THE FOLLOWING ITEMS:

1-HITCH INSERT W/
FILLER PLATES



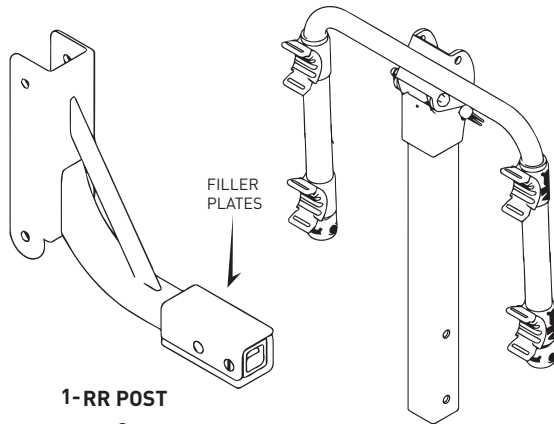

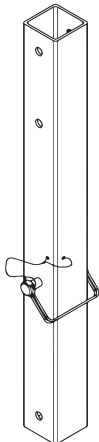

1-CARRY ARM
ASSEMBLY

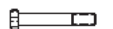

1-RR POST



1—HARDWARE KIT,
CONTAINING:

-  2—3/8" X 2 1/2" BOLT
-  1—3/8" X 3" BOLT
-  4—3/8" LOCK NUT
-  1—1/2" LOCK NUT
-  1—1/2" NO-WOBBLE BOLT
-  1—3/8" NO-WOBBLE BOLT

B. ASSEMBLING RACK:

STEP 1

- INSERT LOWER PORTION OF RR POST INTO HITCH INSERT SO THAT THE HOLES AT THE BOTTOM OF EACH PART LINE UP.
- INSERT THE 3/8" X 3" BOLT THROUGH THE HOLE, AND THREAD 1—3/8" LOCK NUT ONTO THE END OF THE BOLT.
- PIVOT THE RR POST INTO THE UPRIGHT POSITION, SO THAT THE UPPER HOLES LINE UP. INSERT THE QR CLIP THROUGH THESE HOLES, AND SECURE THE WIRE RETAINER CLIP.
- TIGHTEN NUT AND BOLT FIRMLY USING TWO WRENCHES.

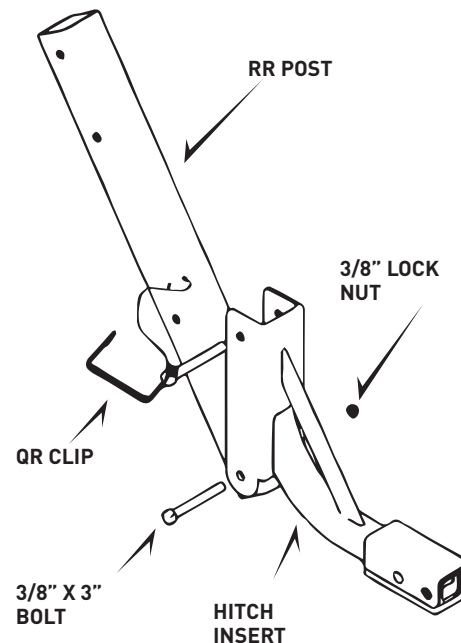

STEP 2

- INSERT CARRY ARM ASSEMBLY INTO UPPER PORTION OF RR POST, LINING UP THE HOLES IN EACH PART.
- INSERT THE 3/8" X 2 1/2" BOLTS THROUGH EACH HOLE, AND THREAD 1—3/8" LOCK NUT ONTO THE END OF THE BOLTS.
- TIGHTEN NUT AND BOLT FIRMLY USING TWO WRENCHES.

NOTE: UPON COMPLETION, BOTH PARTS SHOULD BE FIRMLY JOINED TOGETHER.

IMPORTANT:
 WHEN RACK IS IN AN UPRIGHT POSITION, WIRE RETAINER ON QR CLIP SHOULD ALWAYS BE IN A CLOSED POSITION TO KEEP RACK FROM FALLING OVER DURING USE.

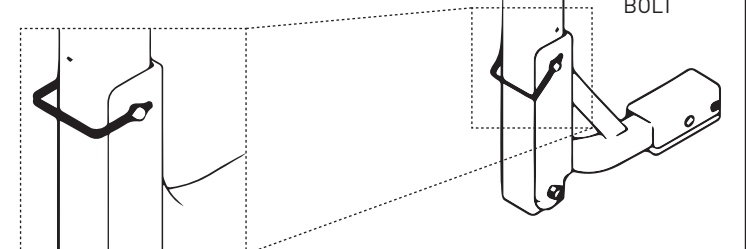

TOOLS REQUIRED: 2—9/16" WRENCH & 2—3/4" WRENCH; OR 2—ADJUSTABLE WRENCHES



C. INSTALLING RACK ONTO VEHICLE:

MODEL ZN520 SHOULD ONLY BE USED ON 2" RECEIVER HITCHES, OR CLASS II 1 1/4" RECEIVER HITCHES INSTALLED ON AUTOMOBILES. NEVER USE THIS RACK ON A TRAILER.

ADJUSTING FOR HITCH SIZE:

FILLER PLATES AND SCREW SHOULD BE INSTALLED/ REMOVED DEPENDING ON THE SIZE OF YOUR RECEIVER HITCH.

FOR 2" HITCHES, FILLER PLATES SHOULD BE INSTALLED WITH FILLER PLATE SCREW BEFORE INSTALLING THE RACK ON YOUR VEHICLE.

FOR 1 1/4" HITCHES, REMOVE FILLER PLATES AND SCREW.

NO-WOBBLE BOLT:

PROPERLY INSTALLING THE NO-WOBBLE BOLT IS CRITICAL FOR PROPER FUNCTIONING OF THE RACK ON 1 1/4" OR 2" HITCHES.

FOR 2" HITCHES, INSTALL THE RACK WITH THE 1/2" (LARGER) NO-WOBBLE BOLT INCLUDED WITH THE PRODUCT.

FOR 1 1/4" HITCHES, INSTALL THE RACK WITH THE 3/8" NOWOBBLE BOLT INCLUDED WITH THE PRODUCT.

INSTALLING THE RACK ON YOUR VEHICLE:

- WITH ARMS IN FOLDED POSITION, INSERT RACK INTO RECEIVER HITCH. LINE UP HOLE IN THE BASE WITH HOLE OF RECEIVER HITCH.
- INSERT NO-WOBBLE BOLT INTO HOLE, MAKING SURE THAT THE SHOULDER OF THE BOLT COMES AGAINST RECEIVER RACK INSIDE OF HITCH.
- TIGHTEN FIRMLY USING TWO - 3/4" OR 9/16" WRENCHES (DEPENDING ON HITCH SIZE). THERE SHOULD NOT BE ANY MOVEMENT OF THE RACK INSIDE OF THE HITCH WHEN DONE.

D. FOLDING UP CARRY ARMS:

- TO FOLD UP CARRY ARMS, REMOVE THE QR CLIP FROM THE CARRY ARM ASSEMBLY, AND SWING CARRY ARMS INTO UPRIGHT POSITION.
- RE-INSTALL THE QR CLIP, MAKING SURE TO PROPERLY CLOSE THE WIRE RETAINER ON THE QR CLIP.
- **IMPORTANT:** WIRE RETAINER MUST BE FULLY CLOSED TO KEEP THE CARRY ARMS IN AN UPRIGHT POSITION DURING USE. PLEASE SEE DRAWING IN STEP 2 ON PAGE 1.

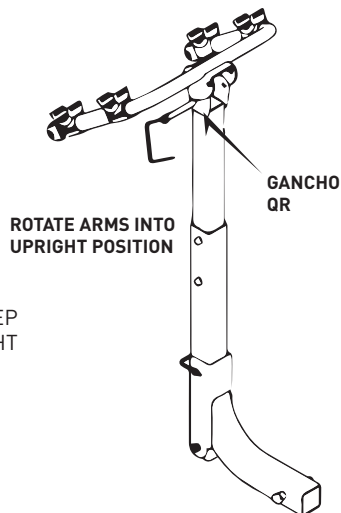

E. LOADING BICYCLES ON RACK:

1. REMOVE ALL LOOSE ITEMS FROM BICYCLES (PUMPS, BAGS, ETC.), AND CHECK THAT ALL QUICK RELEASE HUBS ARE TIGHT.
2. LOAD FIRST BICYCLE WITH ITS CHAIN AND GEARS FACING AWAY FROM RACK. MAKE SURE THAT BICYCLES DO NOT COME IN CONTACT WITH VEHICLE.
3. LOAD SUBSEQUENT BICYCLES IN ALTERNATING DIRECTIONS. FOR BEST WEIGHT DISTRIBUTION, LOAD HEAVIEST BICYCLES FIRST, WITH LIGHTER BICYCLES ON THE OUTSIDE. ADD PADDING BETWEEN BICYCLE CONTACT POINTS, IF NECESSARY.
4. AFTER BICYCLES ARE LOADED, CHECK THAT ENTIRE RACK IS SECURE AND THAT NO-WOBBLE BOLT IS TIGHT, AND THAT THE RACK IS STILL FIRMLY IN PLACE. VISION OUT OF REAR WINDOW MAY BE RESTRICTED—USE SIDE MIRRORS ACCORDINGLY WHEN BACKING UP.

SPECIAL NOTE ON INSTALLING WOMEN'S STYLE FRAMES:

PLACE ONE CARRY ARM UNDER FRONT TOP TUBE. WITH THE OTHER CARRY ARM, ROTATE TIE-DOWN CRADLE, AND PLACE CARRY IN SPACE BEHIND SEAT TUBE AND BELOW REAR DOWN-STAY. **THE ALLEN ADAPTOR BAR** IS ALSO RECOMMENDED FOR THIS APPLICATION.

F. SECURING BIKES TO RACK:

ALL BIKES MUST BE SECURELY TIED TO RACK. USE INDIVIDUAL TIE-DOWN STRAPS, OR ADDITIONAL STRAPS IF NECESSARY.

1. PLACE BICYCLE IN CRADLE.

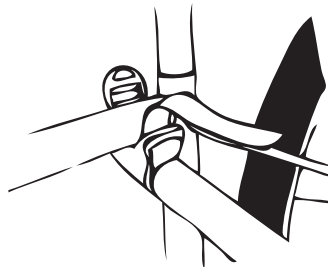

2. THREAD STRAPS.

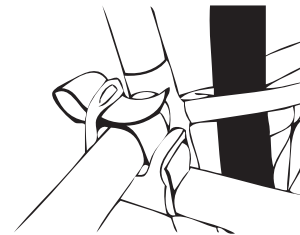

3. PULL STRAP TIGHT.

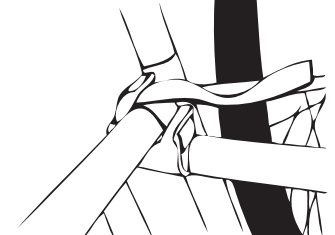

4. USE 70" STRAP (NOT INCLUDED) TO PULL ALL BICYCLES TOGETHER AROUND BOTTOM BRACKETS. STRAP SHOULD ALSO SECURE WHEELS.

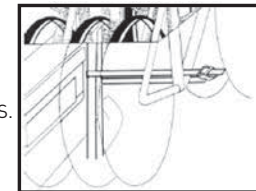

ALLEN LIFETIME WARRANTY:

IF AN ALLEN BIKE RACK IS FOUND TO HAVE A DEFECT IN WORKMANSHIP OR MATERIAL OVER THE LIFETIME OF THE ORIGINAL PURCHASER, ALLEN WILL REPAIR OR REPLACE THE RACK FREE OF CHARGE. THE WARRANTY DOES NOT COVER DAMAGE OR WEAR WHICH OCCURS AS A RESULT OF DAY TO DAY USE OR GENERAL WEAR AND TEAR.



ALLEN SPORTS

ALLEN SPORTS USA
505 BEACHLAND BLVD.
VERO BEACH, FL 32963, USA
CUSTOMERSERVICE@ALLEN.BIKE
WWW.ALLEN.BIKE

Get the latest news, info, give-a-ways and pics on our social media sites!



/AllenSportsUSA



@AllenSportsUSA



@AllenSportsUSA



For More Product Info & List of Dealers Scan Our QR Code