

Free Standing Collection Sek XL



Included Accessories



Free Standing Collection Sek XL

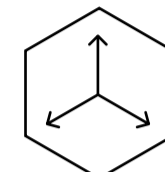
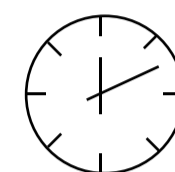
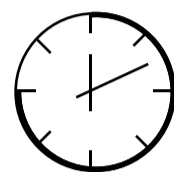
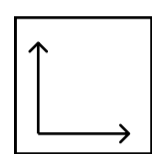
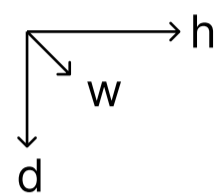

Dimensions H x W x D mm/in	Fuel Capacity	Heats on Average (indoors)	Fuel Consumption	Thermal Output Net (MAX)	Approx. Burn Time	Minimum Room Size (per burner)
1003 x 1359 x 445 39.5 x 53.5 x 17.5	10L	Over 93m ² [1,001 ft ²]	0.51L per hour	27,000 BTU/h 7.9 Kw	20 hours	250 sq. ft.

Awards

2010 Winner Outdoor Hearth Products
Vesta Awards

Application

Indoor & Outdoor

Burner Size

38" Burner

Materials

Stainless Steel Firebox Construction
Brushed Stainless Steel Interior
8mm Tempered Glass On Both Sides

Approx. Weight

190 lbs

Fuel Type

Bio Ethanol Fuel

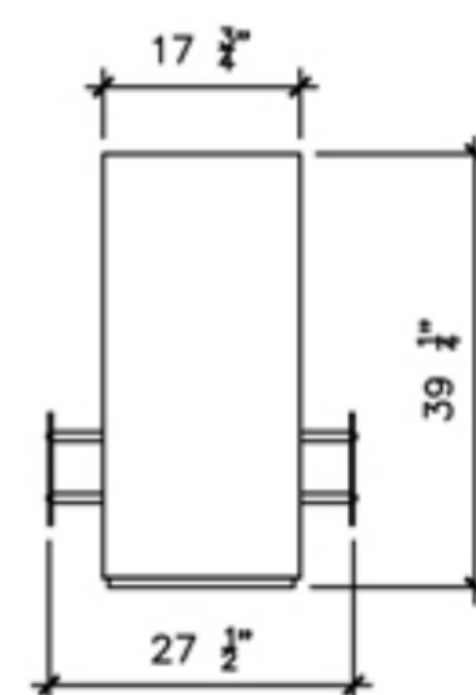
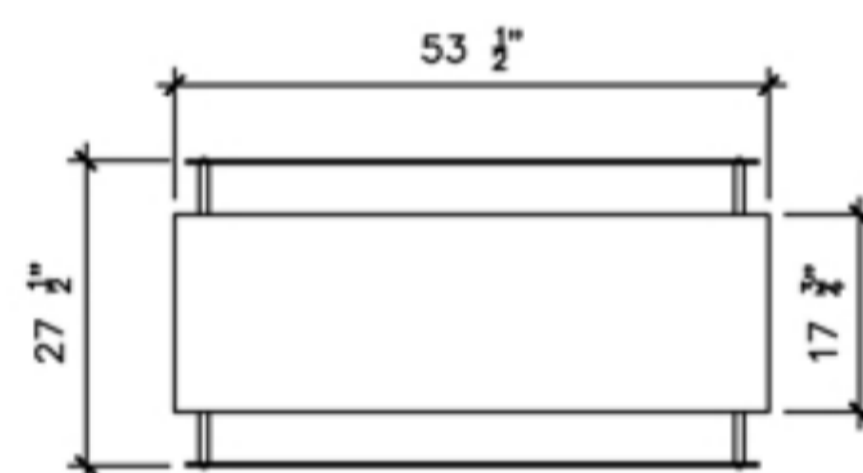
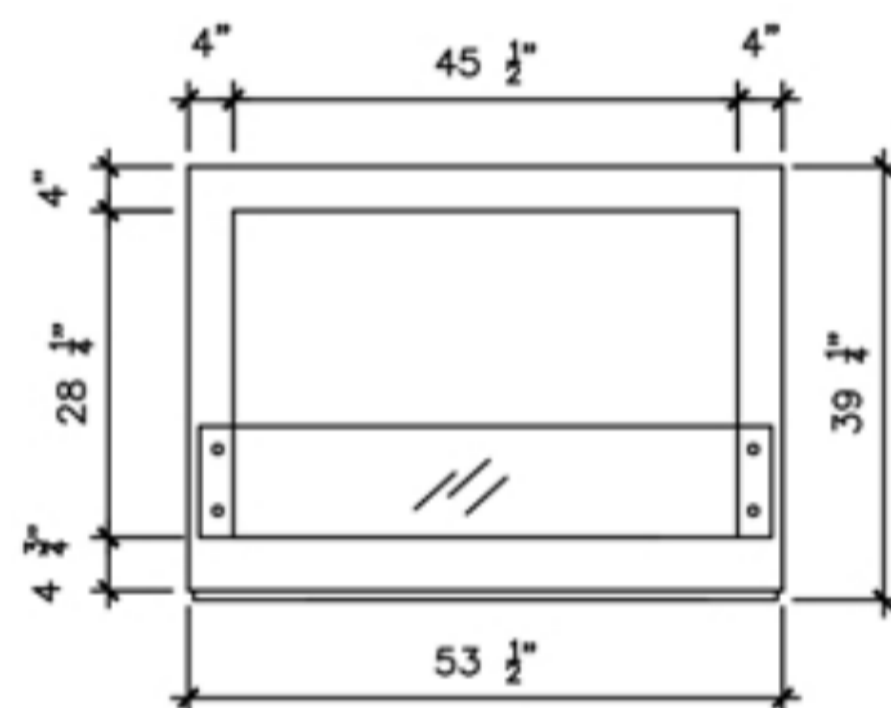

Global Compliance
All burners are UL Listed in accordance with ANSI/
UL1370 in the USA and comply with the ACCC Safety
Mandate for Australia.



Lifetime Warranty

FOR MORE INFORMATION PLEASE REFERENCE THE CLEARANCE & INSTALLATION MANUAL

*Dimensions may vary by 2% (plus or minus) due to material attributes. Template not provided. The Bio Flame recommends using the actual fireplace or burner model when making final cut out

