

HY-C | PRODUCT GUIDE

Chimney Covers, Chase Covers
and Animal Exclusion 4

Wood Management 20

Outdoor Living 23

Hearth Accessories 24

Rotary Cleaning Systems 30

Chimney Systems 34

Warm Air Furnaces 35



Improving Your Life

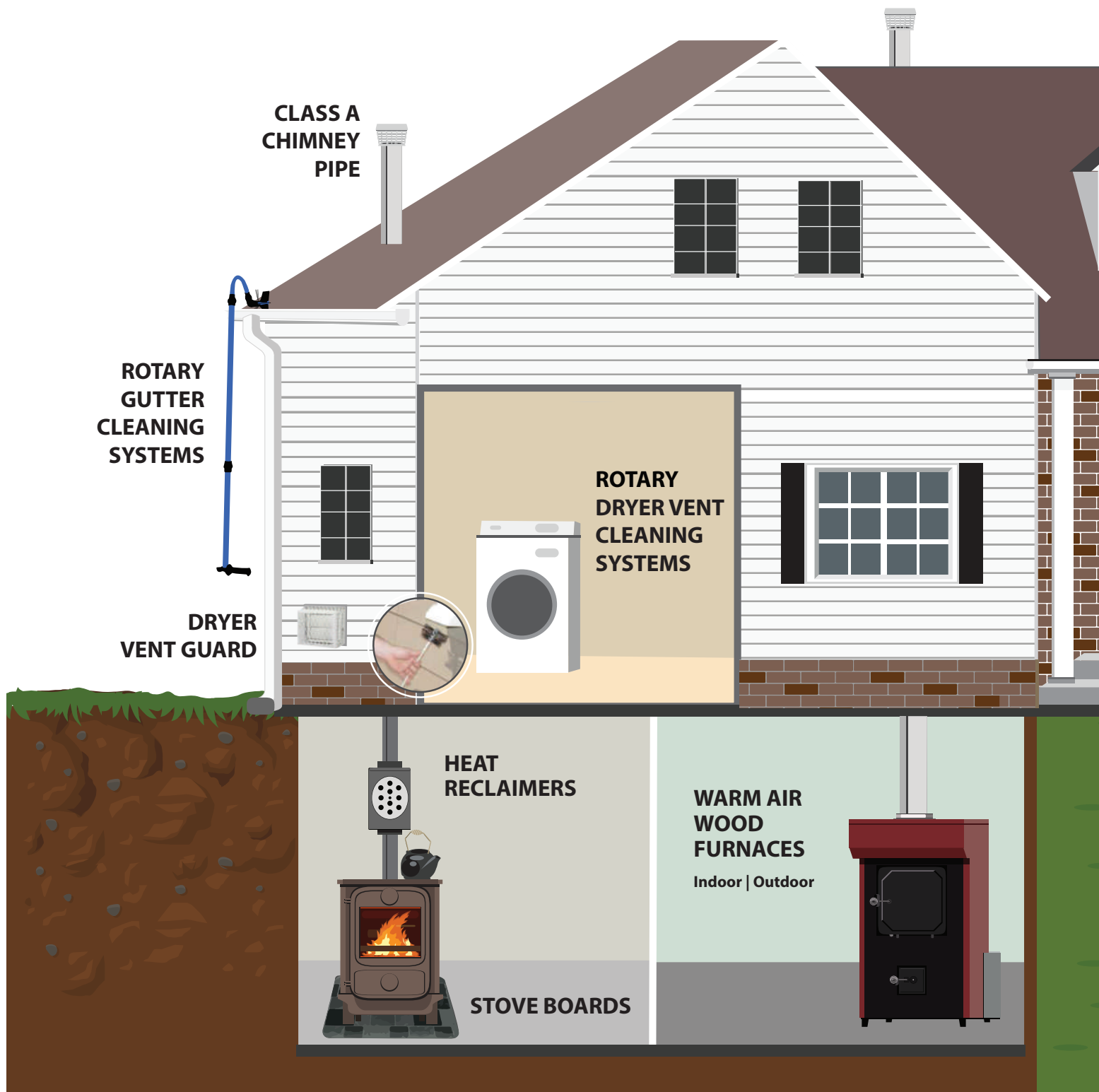

and the Life of Your Home



CHIMNEY PROTECTION

CHIMNEY CAPS & COVERS | CHIMNEY LINERS
ROTARY CHIMNEY CLEANING SYSTEMS

HEARTH ACCESSORIES

HEARTH PROTECTION | GRATES
SMOKE GUARDS | FIRE BACKS

WOOD MANAGEMENT

LOG RACKS & COVERS | ACCESSORIES

OUTDOOR LIVING

PELLET FIRE PITS | FLAME TOWER | FLAME CRADLE

Why HY-C?

HY-C people are passionate and committed to excellence. We are here to provide safe, secure and durable products to Improve Your Life and the Life of Your Home.

HY-C has been protecting homes and families since 1947 with a variety of home improvement products including chimney covers, chase covers, animal exclusion products, stove boards, firewood management solutions, and fireplace accessories. Our new Fire Chief EPA certified wood burning furnaces are engineered to maximize whole home comfort, providing years of dependable heat. Our Gardus LintEater and SootEater do-it-yourself dryer vent and chimney cleaning systems ensure the safety and efficiency of every home! Our newly expanded Flame Genie line of outdoor living products creates ambiance and comfort for gatherings of family and friends.

Because we manufacture almost all of our products in the United States, our customers are not waiting for containers that are 'on the water' and can order by demand -- not forecast, eliminating the risks of high inventory, time delays, out-of-stocks, and poor quality product. We provide what you need when you need it.

Chimney Covers | Draft King™ Single Flue Copper



Copper

FEATURES

- HY-C's Lifetime Limited Warranty
- 24-Gauge 100% Copper Hood with Scalloped Corners and Roll-Formed Edges
- 18-Gauge 3/4" Expanded 100% Copper Mesh
- Removable Hood for Easy Chimney Cleaning
- 16-Gauge Copper Plated Stainless Steel Base for Extra Strength
- Slotted Hex-Head Stainless Steel Mounting Bolts
- Outside Mounting Provides Greater Free Air Space for Better Draft
- Expanded Metal Mesh Turned Inward at Base Allows Cover to Rest Firmly on Tile, Closing any Gaps around the Tile
- Arrests Sparks and Reduces Certain Downdrafts

STOCK NUMBER	OUTSIDE TILE SIZE (IN INCHES)	FITS OUTSIDE TILE DIMENSION (IN INCHES)	APPROX. LBS.
CP99	9 x 9	7½ x 7½ to 9½ x 9½	7
CP913	9 x 13	7½ x 11½ to 9½ x 13½	8.5
CP918	9 x 18	7½ x 16 ½ to 9¼ x 18¼	10
CP1216	12 x 16	10 x 14 to 12¼ x 16¼	11.5
CP1313	13 x 13	11½ x 11½ to 13½ x 13½	10
CP1318	13 x 18	11½ x 16½ to 13¼ x 18¼	12
CP1818	18 x 18	16½ x 16½ to 18 x 18	14.5

Chimney Covers | Draft King™ Single Flue Stainless Steel

STOCK NUMBER	OUTSIDE TILE SIZE (IN INCHES)	FITS OUTSIDE TILE DIMENSION (IN INCHES)	APPROX. LBS.
SS99U	9 x 9	7½ x 7½ to 9½ x 9½	6.5
SS913U	9 x 13	7½ x 11½ to 9½ x 13½	8
SS1313U	13 x 13	11½ x 11½ to 13½ x 13½	9.5
SS1318U	13 x 18	11½ x 16½ to 13¼ x 18¼	11
SS1818U	18 x 18	16½ x 16½ to 18 x 18	13
SS918U	9 x 18	7½ x 16½ to 9¼ x 18¼	9
SS59U	5 x 9	3½ x 7½ to 5½ x 9½	5
SS1216U	12 x 16	10 x 14 to 12½ x 16¼	10.5
SS1111U	11 x 11	9¾ x 9¾ to 12 x 12	9
SS1515U	15 x 15	13¾ x 13¾ to 16 x 16	11.5
SS2020U	20 x 20	18½ x 18½ to 20¼ x 20¼	14
SS811U	10 Round - Slip-In	9½ to 10½ Round	7.5
SS813U	12 Round - Slip-In	11½ to 12½ Round	9.5
SS815U	14 Round - Slip-In	13½ to 14½ Round	10
SS816U	16 Round - Slip-In	15½ to 16½ Round	10.5
SS818U	18 Round - Slip-In	17½ to 18½ Round	11
SS10U	10 Round - Bolt-On	9½ to 10½ Round	6
SS12U	12 Round - Bolt-On	11½ to 12½ Round	8
SS14U	14 Round - Bolt-On	13½ to 14½ Round	9
SS16U	16 Round - Bolt-On	15½ to 16½ Round	12
SS18U	18 Round - Bolt-On	17½ to 18½ Round	13
SSLK	Leg Kit	Option to Convert Draft King Into Slip-In	1.5
SSLK-M	Leg Kit (Packed 25)	Option to Convert Draft King Into Slip-In	38



Stainless Steel

FEATURES

- HY-C's Lifetime Limited Warranty
- 100% 304 Stainless Steel
- 24-Gauge Stainless Steel Hood with Scalloped Corners and Roll-Formed Edges
- 16-Gauge Stainless Steel Base for Extra Strength
- 18-Gauge 3/4" Expanded Stainless Steel Mesh
- 18-Gauge 5/8" Expanded Stainless Steel Mesh Available when Required by Local Jurisdictions
- Slotted Hex-Head Stainless Steel Mounting Bolts
- Outside Mounting Provides Greater Free Air Space for Better Draft
- Expanded Metal Mesh Turned Inward at Base Allows Cover to Rest Firmly on Tile, Closing any Gaps around the Tile
- Optional Heavy-Duty Stainless Steel Leg Kit for Chimneys Where the Tile Does not Extend above the Crown
- Change "U" to "P" for Painted
- Arrests Sparks and Reduces Certain Downdrafts



SSLK - Leg Kit

Chimney Covers | Draft King™ Single Flue Galvanized



Black Galvanized

FEATURES

- HY-C's 7-Year Limited Warranty
- 24-Gauge Galvanized Steel Hood with Scalloped Corners and Turn Down Edges
- 14-Gauge Galvanized Steel Base for Extra Strength
- 18-Gauge 3/4" Expanded Galvanized Steel Mesh
- 18-Gauge 5/8" Expanded Galvanized Steel Mesh Available when Required by Local Jurisdictions
- Attractive Black Powder Coat Finish
- Slotted Hex-Head Mounting Bolts
- Outside Mounting Provides Greater Free Air Space for Better Draft
- Expanded Metal Mesh Turned Inward at Base Allows Cover to Rest Firmly on Tile, Closing any Openings around Tile
- Optional Heavy-Duty Leg Kit for Chimneys Where the Tile Does not Extend above the Crown
- Arrests Sparks and Reduces Certain Downdrafts

STOCK NUMBER	OUTSIDE TILE SIZE (IN INCHES)	FITS OUTSIDE TILE DIMENSION (IN INCHES)	APPROX. LBS.
CBO99	9 x 9	7½ x 7½ to 9½ x 9½	7
CBO913	9 x 13	7½ x 11½ to 9½ x 13½	8
CBO1313	13 x 13	11½ x 11½ to 13½ x 13½	10
CBO1318	13 x 18	11½ x 16½ to 13¼ x 18¼	12
CBO1818	18 x 18	16½ x 16½ to 18 x 18	14.5
CBO918	9 x 18	7½ x 16½ to 9¼ x 18¼	10
CBO59	5 x 9	3½ x 7½ to 5½ x 9½	5.5
CBO1216	12 x 16	10 x 14 to 12½ x 16¼	11.5
CBO1111	11 x 11	9¾ x 9¾ to 12 x 12	9.5
CBO1515	15 x 15	13¾ x 13¾ to 16 x 16	13.5
CBO2020	20 x 20	18½ x 18½ to 20¼ x 20¼	15
CBO811	10 Round - Slip-In	9½ to 10½ Round	8
CBO813	12 Round - Slip-In	11½ to 12½ Round	10.5
CBO815	14 Round - Slip-In	13½ to 14½ Round	11
CBO816	16 Round - Slip-In	15½ to 16½ Round	11.5
CBO818	18 Round - Slip-In	17½ to 18½ Round	12
CBO8	8 Round - Bolt-On	7½ to 8½ Round	5.5
CBO10	10 Round - Bolt-On	9½ to 10½ Round	6
CBO12	12 Round - Bolt-On	11½ to 12½ Round	9
CBO14	14 Round - Bolt-On	13½ to 14½ Round	9.5
CBO16	16 Round - Bolt-On	15½ to 16½ Round	13
CBO18	18 Round - Bolt-On	17½ to 18½ Round	13.5
SSLK	Leg Kit	Option to Convert Draft King Into Slip-In	1.5
SSLK-M	Leg Kit (Packed 25)	Option to Convert Draft King Into Slip-In	38

Note: In situations where Oil or Coal is burned, or when Wood or Pellets are used as the primary source of heat, do not use Aluminum or Black-Painted Galvanized Steel Covers.

Chimney Covers

Draft King™ Single Flue 5/8" Mesh



Stainless Steel - 5/8" Mesh

Manufactured with 5/8" mesh and used only when required by local jurisdictions. [California]

Do not use 5/8" mesh unless mandated by state or local regulations.

STOCK NUMBER STAINLESS	STOCK NUMBER BLK GALV.	OUTSIDE TILE SIZE (IN INCHES)	FITS OUTSIDE TILE DIMENSION (IN INCHES)	APPROX. LBS. STAINLESS	APPROX. LBS. BLK GALV.
SSC59U	CBC59	5 x 9	3½ x 7½ to 5½ x 9½	6.5	7
SSC820U	CBC820	8 x 20 Oval	6½ x 17 to 8½ x 19	10	10.5
SSC817U	CBC817	8 x 17 Oval 9 x 18 Rect.	7½ x 16½ to 9¼ x 18¼	9	10
SSC99U	CBC99	9 x 9	7½ x 7½ to 9½ x 9½	6.5	7
SSC913U	CBC913	9 x 13	7½ x 11½ to 9½ x 13½	8	8
SSC921U	CBC921	9 x 21 Oval	7⅞ x 19⅞ to 9½ x 21⅞	10.5	11
SSC1017U	CBC1017	10 x 17 Oval	9½ x 16½ to 11 x 18½	10.5	11.5
SSC1111U	CBC1111	11 x 11	9¾ x 9¾ to 12 x 12	9.5	10
SSC1216U	CBC1216	12 x 16	10 x 14 to 12½ x 16¼	11	12
SSC1313U	CBC1313	13 x 13	11½ x 11½ to 13½ x 13½	9.5	10
SSC1317U	CBC1317	13 x 17 Oval 13 x 17 Rect.	11½ x 16½ to 13¼ x 18½	11	12
SSC1321U	CBC1321	13 x 21 Oval	12 x 20 to 13½ x 22	13.5	14
SSC1515U	CBC1515	15 x 15	13¾ x 13¾ to 16 x 16	12	14
SSC1721U	CBC1721	17 x 21 Oval	16 x 20 to 17½ x 22	15	15.5
SSC1818U	CBC1818	18 x 18	16½ x 16½ to 18 x 18	13.5	14.5
SSC2020U	CBC2020	20 x 20	18½ x 18½ to 20¼ x 20¼	14.5	15.5
SSC811U	CBC811	10 Round - Slip-In	9½ to 10½ Round	8	8.5
SSC813U	CBC813	12 Round - Slip-In	11½ to 12½ Round	10	11
SSC815U	CBC815	14 Round - Slip-In	13½ to 14½ Round	10.5	11.5
SSC816U	CBC816	16 Round - Slip-In	15½ to 16½ Round	11	12
SSC818U	CBC818	18 Round - Slip-In	17½ to 18½ Round	11.5	12.5
SSC8U	CBC8	8 Round - Bolt-On	7½ to 8½ Round	5.5	6
SSC10U	CBC10	10 Round - Bolt-On	9½ to 10½ Round	6	6.5
SSC12U	CBC12	12 Round - Bolt-On	11½ to 12½ Round	8.5	9.5
SSC14U	CBC14	14 Round - Bolt-On	13½ to 14½ Round	9.5	10.5
SSC16U	CBC16	16 Round - Bolt-On	15½ to 16½ Round	12.5	13.5
SSC18U	CBC18	18 Round - Bolt-On	17½ to 18½ Round	13.3	14

Chimney Covers | BigTop™ Multi-Flue

FEATURES - COPPER

- HY-C's Lifetime Limited Warranty
- 24-Gauge Removable 100% Copper Hood with Scalloped Corners and Roll-Formed Edges
- 24-Gauge Copper-Plated Stainless Steel Base Flanges for Extra Strength in Mounting
- 18-Gauge 3/4" 100% Copper Expanded Metal Mesh, Available in 9", 12" & 14" Heights
- Available with Hinged Mounting Flanges
- Available in Many Stock and Custom Sizes
- Arrests Sparks and Reduces Certain Downdrafts



FEATURES - STAINLESS

- HY-C's Lifetime Limited Warranty
- 24-Gauge Removable 100% 304 Stainless Steel Hood with Scalloped Corners and Roll-Formed Edges
- 24-Gauge 100% 304 Stainless Steel Base Flanges for Secure Mounting
- 18-Gauge 3/4" 100% 304 Stainless Steel Expanded Metal Mesh, Available in 8", 10" & 14" Heights
- 18-Gauge 5/8" 100% 304 Stainless Steel Expanded Metal Mesh [when Required by Local Jurisdictions], Available in 8", 10" & 14" Heights
- Available with Hinged Mounting Flanges
- Available in Many Stock and Custom Sizes
- Arrests Sparks and Reduces Certain Downdrafts



FEATURES - BLACK GALVANIZED

- HY-C's 7-Year Limited Warranty
- 24-Gauge Removable Galvanized Steel Hood with Scalloped Corners and Roll-Formed Edges
- 24-Gauge Galvanized Steel Base Flanges for Secure Mounting
- Attractive Black Powder Coat Paint Finish
- 18-Gauge 3/4" Galvanized Steel Expanded Metal Mesh, Available in 8", 10" & 14" Heights
- 18-Gauge 5/8" Galvanized Steel Expanded Metal Mesh [when Required by Local Jurisdictions], Available in 8", 10" & 14" Heights
- Available in Many Stock and Custom Sizes
- Arrests Sparks and Reduces Certain Downdrafts



Note: In situations where Oil or Coal is burned, or when Wood or Pellets are used as the primary source of heat, do not use Aluminum or Black-Painted Galvanized Steel Covers.

Note: For Covers greater than 26" in width and/or 54" in length (screen to screen size), the lid resembles that of the Band-Around Cover - see page 10.

Install: Use a 3/16" Masonry Bit.



Easy to assemble with tab and slot corner design. Hood attaches to base with weld bolts and nuts; no chance of stripping out threaded holes.

Hinged mounting flanges available on Stainless Steel and Copper models.

HY-C BigTop™ - Easy Solution for Multi-Flue Applications

The Knocked-Down (K) design is very easy to assemble on the job site, eliminating cumbersome storage of large assembled units.

STOCK NUMBER COPPER	STOCK NUMBER STAINLESS	STOCK NUMBER STAINLESS HINGED	STOCK NUMBER BLACK GALVANIZED	SCREEN-TO- SCREEN (IN INCHES)	HOOD SIZE (IN INCHES)	APPROX. LBS.
CBT1010	BT1010	BTH1010	BBT1010	10 x 10	16 x 16	8.5
CBT1014	BT1014	BTH1014	BBT1014	10 x 14	15¼ x 19¼	9
CBT1319	BT1319	BTH1319	BBT1319	13 x 19	20¼ x 25¼	11.5
CBT1414	BT1414	BTH1414	BBT1414	14 x 14	20¼ x 20¼	10
CBT1717	BT1717	BTH1717	BBT1717	17 x 17	25¼ x 25¼	13
CBT1421K	BT1421K	BTH1421K	BBT1421K	14 x 21	22¼ x 34½	15.5
CBT1426K	BT1426K	BTH1426K	BBT1426K	14 x 26	22¼ x 34½	16
CBT1430K	BT1430K	BTH1430K	BBT1430K	14 x 30	22¼ x 34½	16.5
CBT1434K	BT1434K	BTH1434K	BBT1434K	14 x 34	22¼ x 46½	19.5
CBT1537K	BT1537K	BTH1537K	BBT1537K	15 x 37	22¼ x 46½	20
CBT1729K	BT1729K	BTH1729K	BBT1729K	17 x 29	22¼ x 34½	16.5
CBT1735K	BT1735K	BTH1735K	BBT1735K	17 x 35	22¼ x 46½	19
CBT1741K	BT1741K	BTH1741K	BBT1741K	17 x 41	22¼ x 46½	21
CBT1749K	BT1749K	BTH1749K	BBT1749K	17 x 49	22¼ x 58¼	22
CBT1753K	BT1753K	BTH1753K	BBT1753K	17 x 53	22¼ x 58¼	23
CBT1758K	BT1758K	BTH1758K	BBT1758K	17 x 58	22¼ x 69¼	27
CBT1764K	BT1764K	BTH1764K	BBT1764K	17 x 64	22¼ x 69¼	29

■ Shipped assembled only

□ Stock sizes and custom sizes shipped knocked-down to minimize freight expense and to avoid shipping damage. Tube of all-weather construction adhesive cannot be shipped air freight.

CUSTOM-MADE BigTop™

Available with the following limitations:

COVER TYPE	MAX WIDTH	MAX LENGTH
Copper	40"	88"
Stainless	40"	88"
Black	40"	96"

All units ≥ 32" width, will be shipped with a minimum of 10" mesh

FEATURES

- HY-C's Lifetime Limited Warranty for Copper and Stainless Steel, HY-C's 7-Year Limited Warranty on Black Galvanized Steel
- Heavy-Duty Welded Construction
- 24-Gauge Removable Hood for Easy Cleaning
- Scalloped Corners and Roll-Formed Edges Add Style and Safety
- Knocked Down BigTops are Assembled at the Factory Before Shipping to Assure the Proper Fit of All Parts
- Tapmark Masonry Screws and Tube(s) of All-Weather Construction Adhesive Included
- Arrests Sparks and Reduces Certain Downdrafts

Chimney Covers | Multi-Pack Single Flue Stainless Steel

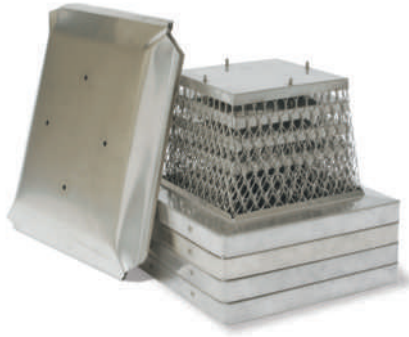

FEATURES

- 100% 304 Stainless Steel
- HY-C's Lifetime Limited Warranty
- Space Saving Design and Package
- Easy Assembly, Lids Attach in Seconds with Wing Nuts (included) and Weld Bolts to Prevent Stripping
- Arrests Sparks and Reduces Certain Downdrafts
- Removable 24-Gauge Hood with Roll-Formed Edges
- Ships Nested in a 4-pack Carton
- 16-Gauge Stainless Steel Base for Extra Strength
- 18-Gauge 3/4" Expanded Stainless Steel Mesh
- Side Bolt-on Mounting with Pointed Stainless Steel Slotted Hex-head Bolts with Weld Nuts to Prevent Stripping

STOCK NUMBER	OUTSIDE TILE SIZE (IN INCHES)	FITS OUTSIDE TILE DIMENSION (IN INCHES)	CARTON PACK	APPROX. LBS
MPSS99	9 x 9	7½ x 7½ to 9½ x 9½	4	22
MPSS913	9 x 13	7½ x 11½ to 9½ x 13½	4	27
MPSS918	9 x 18	7½ x 16½ to 9½ x 18¼	4	34
MPSS1212	12 x 12	10½ x 10½ to 12½ x 12½	4	33
MPSS1313	13 x 13	10½ x 11½ to 13½ x 13½	4	34
MPSS1318	13 x 18	11½ x 16½ to 13¼ x 18¼	4	45

Chimney Covers | Liner Cap Single Flue Stainless Steel

STOCK NUMBER	OUTSIDE TILE SIZE (IN INCHES)	FITS OUTSIDE TILE DIMENSION (IN INCHES)	APPROX. LBS.
LC4	4	3½ to 4½	4
LC5	5	4½ to 5½	4
LC6	6	5½ to 6½	4.3
LC7	7	6½ to 7½	4.3
LC8	8	7½ to 8½	5
LC9	9	8½ to 9½	5
LC10	10	9½ to 10½	5.5
LC11	11	10½ to 11½	6
LC12	12	11½ to 12½	6
LC13	13	12½ to 13½	6.5
LC14	14	13½ to 14½	6.5



HY-C's liner cap is specifically designed to fit rigid and flexible stainless steel liners. It is also adaptable for use with clay flue liners and other round applications.

FEATURES

- 100% 304 Stainless Steel
- HY-C's Lifetime Limited Warranty
- Completely Assembled With Welded Construction
- Liner Cap Is Easily Mounted With 1½" Draw Band
- Removable 18-Gauge 3/4" Expanded Stainless Steel Mesh
- Removable 18-Gauge 5/8" Expanded Stainless Steel Mesh Available when Required by Local Jurisdictions
- Stainless Steel Gear-Drawn Clamp Band
- 24-Gauge Hood
- 24-Gauge Base
- 18-Gauge Braces
- Arrests Sparks and Reduces Certain Downdrafts

Chimney Covers | Universal Covers

Now available from HY-C: Reliable and Easy-to-Install Universal Chimney Covers with Anchoring System

FEATURES

- Available in 22-Gauge 304 Stainless Steel or 22-Gauge Galvanized Steel with Black Powder Coat Finish
- HY-C's Lifetime Warranty on Stainless Steel
HY-C's 7-Year Limited Warranty on Galvanized
- Designed Specifically for California Market
- Secure, Inside Anchoring System is Ideal for Windy Conditions
- Available in 3/4" or 5/8" Mesh
- **Do Not Use 5/8" Mesh Unless Required by Local Jurisdictions**
- Arrests Sparks and Reduces Certain Downdrafts



Black Galvanized, Standard 3/4" Mesh



Stainless Steel, Standard 3/4" Mesh



Black Galvanized, 5/8" Mesh



Stainless Steel, 5/8" Mesh

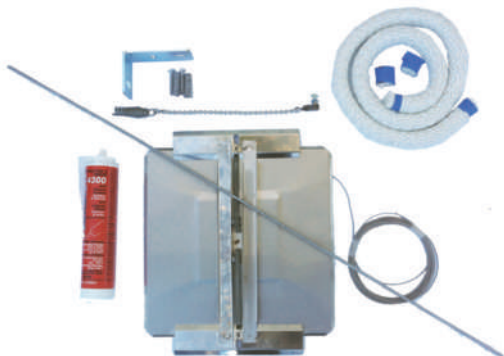

Damper Kit, available in both sizes

STOCK NO	DESCRIPTION	APPROX. LBS.
U1313B34	13 x 13 Black Galvanized	8.5
U1313S34	13 x 13 Stainless Steel	8
U1313B58	13 x 13 Black Galvanized, 5/8" Mesh	9
U1313S58	13 x 13 Stainless Steel, 5/8" Mesh	8
UD1313	13 x 13 Damper Kit	6
U1320B34	13 x 20.5 Black Galvanized	11
U1320S34	13 x 20.5 Stainless Steel	10
U1320B58	13 x 20.5 Black Galvanized, 5/8" Mesh	11
U1320S58	13 x 20.5 Stainless Steel, 5/8" Mesh	10
UD1320	13 x 20.5 Damper Kit	7

Aluminum and Stainless Steel

ALUMINUM

Custom covers can be built to fit virtually any size chimney. Aluminum is recommended for most applications for low cost and minimal maintenance requirements.

Maximum base size: 60" wide x 96" long

STAINLESS STEEL

Stainless Steel is recommended for use with coal or oil burning heating appliances. Backed by HY-C's Lifetime Limited Warranty.

Maximum base size: 48" wide x 96" long



The hood overhangs masonry approximately 3" on both sides and ends. The cover attaches securely to the chimney with a 2 1/4" draw band. Four adjustable corner clamps provide flexibility for proper fit.

How To Order:

1) Measure the outside dimension of all four sides of the top row of brick.

2) Measure the tile height from the top of the first row of brick, to the top of the tallest tile.

Example Top View

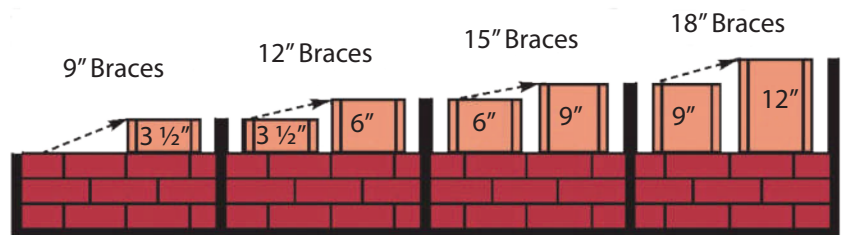
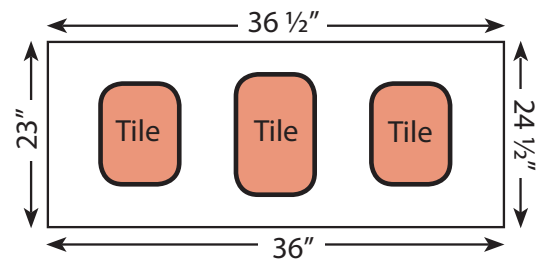

Standard 9" braces and expanded metal mesh are used when flue tile height is 3 1/2" or less. If tile height is greater, refer to the chart.

Note:

All custom chimney covers are shipped knocked down.

All units ≥ 32 " width will be shipped with a minimum of 12" mesh.

All custom chimney covers arrest sparks and reduce certain downdrafts.

In situations where oil or coal is burned, or when wood or pellets are used as the primary source of heat, do not use aluminum covers.

Chimney Covers | Custom Made Skirt Type

Aluminum, Stainless Steel and Copper

ALUMINUM

Custom covers can be built to fit virtually any size chimney. Aluminum is recommended for applications requiring a low cost option with minimal maintenance requirements.

Maximum base size: 60" wide x 96" long

STAINLESS STEEL

Stainless Steel is recommended for use with coal or oil burning heating appliances.

Backed by HY-C's Lifetime Limited Warranty.

Maximum base size: 48" wide x 96" long

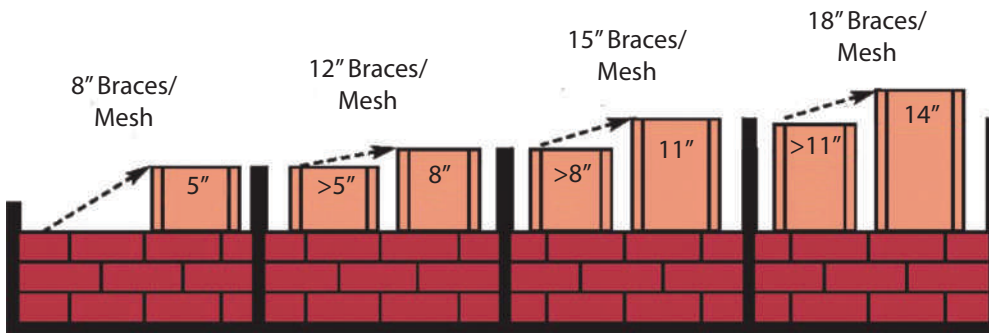

For Aluminum and Stainless Steel, standard 8" braces and expanded metal mesh are used when flue tile height is 6½" or less. If tile height is greater, refer to the chart.

COPPER

Enhance the beauty of your home while protecting your chimney with a copper custom-made cover. Match your copper trim, gutters, or awnings.

Backed by HY-C's Lifetime Limited Warranty.

Maximum base size: 38" wide x 88" long

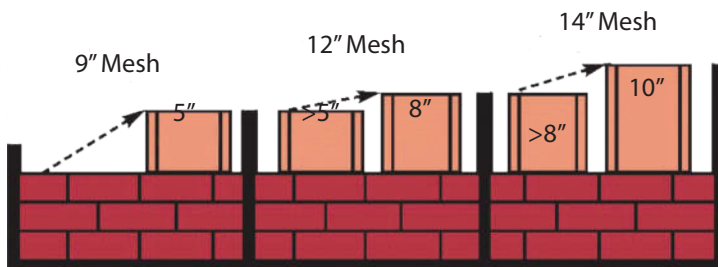

For Copper, standard 9" expanded metal mesh is used when flue tile height is 5" or less. If tile height is greater, refer to the chart.



The hood overhangs masonry approximately 1" on both sides and ends. 4¾" skirt protects cement crown from deterioration due to weather. Copper and Stainless Steel are constructed in the same manner.

Chimney Covers

Adjustable Single Flue Galvanized



Black Galvanized Adjustable

FEATURES

- HY-C's 7-Year Limited Warranty
- One Cover Fits Several Flue Tile Sizes, Reducing SKUs
- Quick and Easy Installation
- Helps Protect Masonry Chimney from Deterioration
- Helps Protect Internal Metal Fireplace Fixtures
- Keeps out Rain, Birds, Animals and Debris
- Arrests Sparks and Reduces Certain Downdrafts
- 24-Gauge Galvanized Hood
- 3/4" Expanded Galvanized Steel Mesh
- 5/8" Expanded Galvanized Steel Mesh Available when Required by Local Jurisdictions (Stock #SCADJ-S-C & SCADJ-L-C)
- Attractive Black Powder Coat Finish

STOCK NUMBER	FITS OUTSIDE TILE SIZE (IN INCHES)		APPROX. LBS
SCADJ-S	8 x 8		8
	9 x 9		
	8 x 12		
	9 x 13		
	12 x 12		
	13 x 13		
	8 Round		
	10 Round		
	12 Round		

STOCK NUMBER	FITS OUTSIDE TILE SIZE (IN INCHES)		APPROX. LBS
SCADJ-L	13 x 13		10
	13 x 18		
	9 x 18		
	12 x 16		
	8 x 17 Oval		
	10 x 17 Oval		
	13 x 17 Oval		

Chimney Covers

Duro-Shield™ Single Flue Aluminum

STOCK NUMBER	OUTSIDE BRICK SIZE (IN INCHES)	FITS OUTSIDE BRICK DIMENSION (IN INCHES)	APPROX. LBS.
188B	16 x 16	15½ x 15½ to 17½ x 17½	5.5
180B	17 x 17	16½ x 16½ to 18½ x 18½	5.7
182B	17 x 21	16½ x 20½ to 18½ x 22½	6.5
184B	21 x 21	20½ x 20½ to 22½ x 22½	7.5



Duro-Shield™ Aluminum Band-Around-Brick

Hood is made from 18-gauge diamond embossed aluminum. Braces are 1/8" and 3/4" extruded aluminum. Mesh is 16-gauge aluminum expanded metal. Band is 2 1/4" 18-gauge diamond embossed aluminum. Nuts and bolts are stainless steel.

All covers shipped knocked down.

Assembly required. Easy to install.



Duro-Shield™ Aluminum Multi-Fit

Hood is made from 18-gauge diamond embossed aluminum. Braces are 1/8" and 1" extruded aluminum. Mesh is 16-gauge aluminum expanded metal. Nuts and bolts are stainless steel.

STOCK NUMBER	OUTSIDE TILE SIZE (IN INCHES)	FITS OUTSIDE TILE DIMENSION (IN INCHES)	APPROX. LBS.
MF303	9 x 9	7 x 7 to 9½ x 9½	4
	9 x 13	7 x 11½ to 9½ x 13½	
	13 x 13	11½ x 11½ to 13½ x 13½	
	10 Round	9 to 10 Round	
MF304	12 Round	11½ to 12½ Round	4.5
	13 x 13	11½ x 11½ to 13½ x 13½	
	13 x 18	11½ x 17 to 13½ x 18¼	
	9 x 18	7 x 17½ to 9½ x 18¼	
	12 x 16	11½ x 15 to 12½ x 16½	
	8 x 17 Oval	any near size	
	13 x 17 Oval	any near size	
10½ x 18 Oval	any near size		
MF305	18 x 18	17½ x 17½ to 18¼ x 18¼	5
	14 Round	13 to 14½ Round	
	16 Round	16 to 17 Round	
	18 Round	17½ to 18¼ Round	

Chase Covers | Custom-Made



FEATURES

- Available in 22-Gauge 304 Stainless Steel or 22-Gauge Galvanized Steel
- Black or White Powder Coat Finish is Available for an Upcharge
- Custom Built to Ensure a Proper Fit
- HY-C's Lifetime Warranty on Stainless Steel, HY-C's 7-year Limited Warranty on Galvanized Steel
- Cross Break to Shed Water and Provide Stability
- Corners are Welded for Superior Strength
- Protects Home from Water Damage
- Helps Maintain Safe Operation of Fireplace

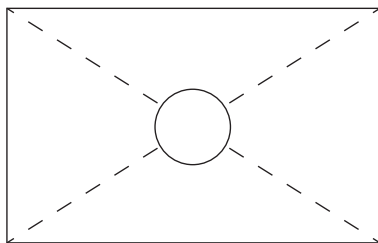

Top View

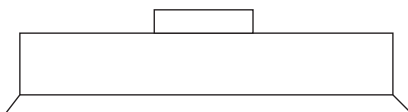

Side View

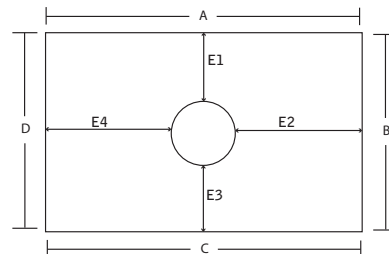

Single Hole

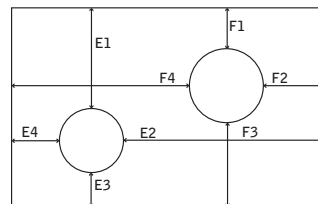

Double Hole

How to Measure for a Custom Chase Cover:
(Give all dimensions to the nearest 1/8")

1. Measure the perimeter of the chimney, beginning with the longest side and going clockwise.
2. Measure the height of the skirt – 3" is standard.
3. Measure the diameter of the hole or each hole if there are more than one. Then measure the distance from the edge of each hole to each of the four sides.
4. 2" is the standard collar height. If a storm collar is needed, give outside diameter of each pipe.

Animal Exclusion | HY-GUARD™ Screens

Raccoon Screen

STOCK NUMBER	OUTSIDE TILE SIZE (IN INCHES)	FITS OUTSIDE TILE DIMENSION (IN INCHES)	APPROX. LBS.
RC99	9 x 9	7½ x 7½ to 9½ x 9½	5
RC913	9 x 13	7½ x 11½ to 9½ x 13½	5.5
RC1313	13 x 13	11½ x 11½ to 13½ x 13½	6.5
RS99	9 x 9	7½ x 7½ to 9½ x 9½	4.5
RS913	9 x 13	7½ x 11½ to 9½ x 13½	5
RS1313	13 x 13	11½ x 11½ to 13½ x 13½	6

RC = Black-Painted Steel RS = Stainless Steel



FEATURES

- RC Units are Constructed with Heavy 18-Gauge Galvanized 5/8" mesh; Base is 14-Gauge Galvanized Steel
- Standard Height is 6"
- Galvanized Units are Painted Black, Stainless Steel Units are Unpainted
- Tamper-Proof Bolt-on Attachment Method, Animal Pests are Unable to Remove the Screen to Gain Access to the Chimney Liner
- RS Units are 100% 304 Stainless Steel Constructed with Heavy 18-Gauge 5/8" Mesh; Base is a Durable 16-Gauge Stainless Steel

Spark Arrestor/ Bird and Squirrel Screen

STOCK NUMBER	FITS OUTSIDE TILE DIMENSION (IN INCHES)	APPROX. LBS.
2020	8 x 8 or 9 x 9*	3
2025	8 x 12 or 9 x 13*	3
2525	12 x 12 or 13 x 13*	3.5
1010	10 Round	2.5
1212	12 Round	3
1414	14 Round	3.5

*Fits either size



NO TOOLS NEEDED! The Screens are easy to install, simply slip the heavy corner fins down into the flue tile.

FEATURES

- Heavy 16-Gauge 5/8" Galvanized Steel Mesh
- Effective Barrier to Keep Small Animal Pests Such as Birds and Squirrels Out of the Chimney
- Galvanized Steel with Black Powder Coat Finish

Dryer VentGuard

STOCK NUMBER	SIZE (W x D x H) (IN INCHES)	CASE PACK	APPROX. LBS.
RVG-DVG	7 x 7 x 5	1	1
RVG-DVG-3	7 x 7 x 5	3	2
RVG-DVG-6	7 x 7 x 5	6	4



FEATURES

- Easy to Install Over Most 3" or 4" Dryer or Bathroom Exhaust Vents
- Prevents Small Animals Such as Birds, Squirrels and Other Rodents from Nesting in Dryer Vents
- 100% 304 Stainless Steel Mesh that will Not Rust or Corrode
- Durable White Powder Coat Finish Blends into Most Exterior Surfaces
- Easy Keyhole On/Off for Recommended Monthly Maintenance

Stainless Steel

STOCK NUMBER	SCREEN SIZE* (IN INCHES)	CASE PACK	APPROX. LBS.
RVG77	7 x 7 Base x 9 Height	1	1.5
RVG77-3	7 x 7 Base x 9 Height	3	5
RVG77P	7 x 7 Base x 9 Height	1	1.5
RVG77-3P	7 x 7 Base x 9 Height	3	5
RVG1111	11 x 11 Base x 13 Height	1	2.5
RVG1111-3	11 x 11 Base x 13 Height	3	9
RVG1111P	11 x 11 Base x 13 Height	1	2.5
RVG1111-3P	11 x 11 Base x 13 Height	3	9
RVG1616	16 x 16 Base x 5 Height	1	3.5
RVG1616-3	16 x 16 Base x 5 Height	3	10
RVG1616P	16 x 16 Base x 5 Height	1	3.5
RVG1616-3P	16 x 16 Base x 5 Height	3	10
RVG2525L	25 x 25 Base x 6 Height	1	7
RVG2525L-3	25 x 25 Base x 6 Height	3	21.5
RVG2525LP	25 x 25 Base x 6 Height	1	7
RVG2525L-3P	25 x 25 Base x 6 Height	3	21.5
RVG2525	25 x 25 Base x 12 Height	1	7.5
RVG2525-3	25 x 25 Base x 12 Height	3	22
RVG2525P	25 x 25 Base x 12 Height	1	7.5
RVG2525-3P	25 x 25 Base x 12 Height	3	22
RVG3030	30 x 30 Base x 12 Height	1	9
RVG3030-3	30 x 30 Base x 12 Height	3	26
RVG3030P	30 x 30 Base x 12 Height	1	9
RVG3030-3P	30 x 30 Base x 12 Height	3	26

P = Stainless Steel Painted Black

* For Flange size, add 1.25" per side

Black Painted Galvanized Steel

STOCK NUMBER	SCREEN SIZE* (IN INCHES)	CASE PACK	APPROX. LBS.
RVG77G	7 x 7 Base x 9 Height	1	1.5
RVG77-3G	7 x 7 Base x 9 Height	3	5
RVG1111G	11 x 11 Base x 13 Height	1	2.5
RVG1111-3G	11 x 11 Base x 13 Height	3	9
RVG1616G	16 x 16 Base x 5 Height	1	3.5
RVG1616-3G	16 x 16 Base x 5 Height	3	10
RVG2525LG	25 x 25 Base x 6 Height	1	7
RVG2525L-3G	25 x 25 Base x 6 Height	3	21.5
RVG2525G	25 x 25 Base x 12 Height	1	7.5
RVG2525-3G	25 x 25 Base x 12 Height	3	22
RVG3030G	30 x 30 Base x 12 Height	1	9
RVG3030-3G	30 x 30 Base x 12 Height	3	26

* For Flange size, add 1.25" per side

KEEPS OUT RACCOONS, OPOSSUM, SQUIRRELS AND OTHER PESKY ANIMALS

Roof VentGuard™ from HY-C prevents animals from entering your home through roof vents. Most roof vents are made of a plastic material with simple window type screening or no screening at all. Animals can and do chew through these vents to enter the attic where they can destroy wiring, cause leaks and do severe damage to your home.



Power Ventilator



Static Vent



Dryer Vent

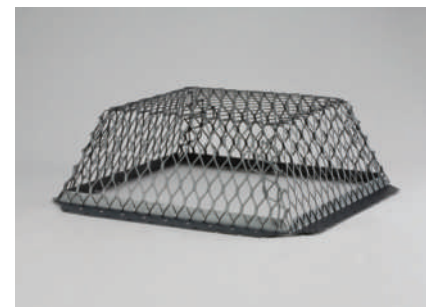

Tapered Stackable Design

FEATURES

- Made from Heavy-Duty 18-Gauge Expanded Mesh in Stainless Steel or Galvanized Steel
- Available in Multiple Sizes to Fit a Wide Variety of Vent Applications

Control the wild and protect your roof vents by covering them with VentGUARD PLUS!

VentGUARD PLUS protects roof vents against wildlife, falling debris, hail, and damage from snow removal



DESCRIPTION	CASE PACK	APPROX. LBS.
1 VentGUARD PLUS	1	8
1 VentGUARD PLUS	6	47.5

Dimensions:

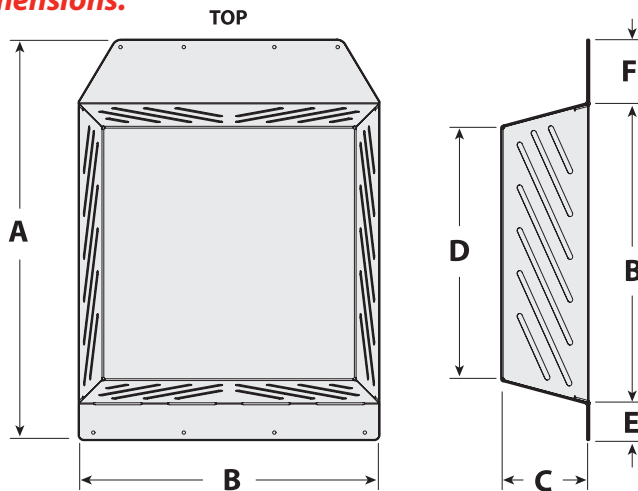

A	B	C	D	E	F
22"	16.5"	4.8"	14"	2"	3.5"

FEATURES

- Covers Standard Roof Vents
- Retains Venting Area of 50 sq. in.
- Simple Cover and Screw Application
- Ideal for all Roof Pitches
- Built-in Drainage Design
- 100% Recyclable
- Powder Coated Galvanized Steel
- Covers Faded and Damaged Vents
- U.S. and Canada Patents

Animal Exclusion | HY-GUARD™ Pest Armor™

Architectural Steel Mesh Pest Exclusion Profiles!

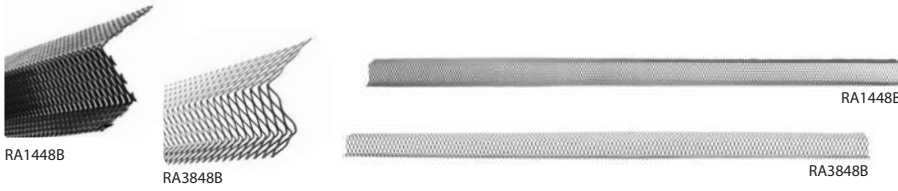

STOCK NUMBER	MESH	LENGTH (IN INCHES)	CASE PACK	APPROX. LBS.
RA1448B	1/4"	48"	40 pcs. - 160 lf.	35
RA3848B	3/8"	48"	40 pcs. - 160 lf.	23

FEATURES

- Prevents Animal and Pest Intrusion
- Fits Over Existing Roof Vent: Saves Labor and Eliminates Risk of Damage with Tear-Off Solutions
- Available in 1/4" Tight Mesh or 3/8" Mesh
- Durable Black Powder Coat Finish

Animal Exclusion | HY-GUARD™ Foundation VentGuard™

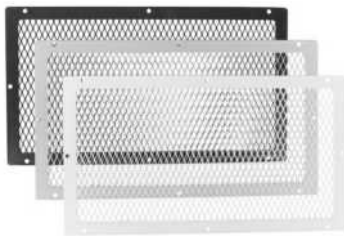

Keep Rodents, Snakes, and Birds from Entering the Home Through Foundation Vents!

STOCK NUMBER	BASE SIZE (IN INCHES)	CASE PACK	APPROX. LBS.
VG1018G-1B	10½ x 18½	1	1½
VG1018G-10B	10½ x 18½	10	12¾
VG1018G-1G	10½ x 18½	1	1½
VG1018G-10G	10½ x 18½	10	12¾
VG1018G-1W	10½ x 18½	1	1½
VG1018G-10W	10½ x 18½	10	12¾

FEATURES

- Design Features a Sturdy 1" Frame with Hemmed Edges for Extra Strength
- 18-Gauge, 3/8" Expanded Metal Mesh will Exclude Most Animals and Pests
- One-Piece, Galvanized Steel Frame Measures 10½" x 18½"
- Easy to Install Screens Provide a Clean, Professional Exclusion Solution
- Durable White (W), Black (B), or Gray (G) Powder Coat Finishes

Animal Exclusion | HY-GUARD™ Soffit VentGuard™

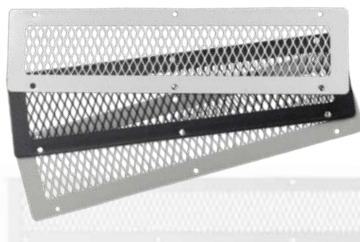

Keep Birds and Squirrels from Entering the Home Through Soffit Vents!

STOCK NUMBER	BASE SIZE (IN INCHES)	CASE PACK	APPROX. LBS.
VG0416G-1B	4 x 16	1	½
VG0416G-10B	4 x 16	10	6
VG0416G-1G	4 x 16	1	½
VG0416G-10G	4 x 16	10	6
VG0416G-1W	4 x 16	1	½
VG0416G-10W	4 x 16	10	6
VG0450G-1W	40 x 50	1	1½
VG0450G-10W	40 x 50	10	12

FEATURES

- Design Features a Sturdy 1" Frame with Hemmed Edges for Extra Strength
- 18-Gauge, 3/8" Expanded Metal Mesh will Exclude Most Animals and Pests
- One-Piece, Galvanized Steel Frame Measures 4" x 16" or 4" x 50"
- Easy to Install Screens Provide a Clean, Professional Exclusion Solution
- Durable White (W), Black (B), or Gray (G) Powder Coat Finishes
- 4" x 50" Size Available in White Powder Coat Only

Log Racks | Crescent

Black-Painted Square Tube Steel

STOCK NO	DESCRIPTION	SIZE (L X D X H) (IN INCHES)	APPROX. LBS.
SCRM	Medium Crescent Log Rack	48 x 14 x 40	30
SCRM-T	Table Top for Medium Crescent	50 x 14 x 1	11
SCRXL	Extra Large Crescent Log Rack	96 x 13 x 45	86



SCRM with SCRM-T



1.25" Square Tube; Holds 1/5 Cord of Wood



SCRM with SCRM-T



SCRXL
1.5" Square Tube; Holds 1/3 Cord of Wood

FEATURES

- Heavy-Duty Square Tube Steel Construction Protects and Neatly Stores Your Firewood
- 14-Gauge Steel (SCRXL) and 16-Gauge Steel (SCRM and SCRM-T)
- Protects Firewood from Rot, Termites, and Nesting Wildlife
- Black Powder Coat Finish Resists Chipping and Corrosion
- Easy to Assemble/Disassemble in Minutes

Log Racks | Adjustable

Black Painted Steel

STOCK NO	DESCRIPTION	SIZE (L x D x H) (IN INCHES)	APPROX. LBS.
SLRA	Black-Painted Tubular Steel Log Rack Kit	Adj. x 13 x 42	15
SLRK	Black-Painted Steel Log Rack Bracket Kit - Screws Included	Adj. x 14 x Adj.	6

STORES YOUR FIREWOOD NEATLY AND SAFELY ABOVE THE GROUND



SLRA



SLRK

FEATURES

- Add 2 x 4's of Any Length to Customize the Storage You Need
- Heavy-Duty Construction
- Black Powder Coat Finish
- Helps Protect Your Firewood from Rot, Termites and Insects
- Easy to Assemble/Disassemble in Minutes

Log Racks | Deluxe

Black-Painted Tubular Steel

STOCK NO	DESCRIPTION	SIZE (L x D x H) (IN INCHES)	APPROX. LBS.
SLRS	Small Tubular Steel Rack - Ideal for Hearthside, Garage or Patio use	28 x 12 x 33	13
SLRM	Medium Tubular Steel Rack - Convenient Size Suitable for Patio or Garage	45 x 13 x 45	18
SLRXL	Extra Large Tubular Steel Rack - Extra Large Capacity, Full 8' Length	96 x 13 x 45	26
SLRXLT	Extra Large Tall Tubular Steel Rack - Extra Large 5' Tall Capacity, Full 8' Length	96 x 13 x 60	32

STORES YOUR FIREWOOD NEATLY AND SAFELY ABOVE THE GROUND

FEATURES

- Open-Air Design Provides Ventilation for Seasoning Firewood and for Cleaner, Safer Burning
- Heavy-Duty Steel Construction
- Protects Firewood from Rot, Termites, and Nesting Wildlife
- Black Powder Coat Finish Resists Chipping and Corrosion
- Easy to Assemble/Disassemble in Minutes
- Optional Covers Available



SLRM

SLRXL

TESTED TO 4,000 LBS

Made in the U.S.A.

Log Racks | Extender Log Rack

FEATURES

- Heavy-duty 16-Gauge, 1 1/4" Square Tube Construction, Holds Up to 3,000 lbs.
- Holds 1/5 Cord of Wood; Made in U.S.A.
- Protects Firewood from Rot, Termites, and Nesting Wildlife
- Black Powder Coat Finish Resists Chipping and Corrosion
- Easy to Assemble/Disassemble in Minutes
- Add Extender Kit (SERM-EXT) to Base Unit (SERM) to Extend Log Rack up to 8 Ft, 12 Ft, or 16 Ft

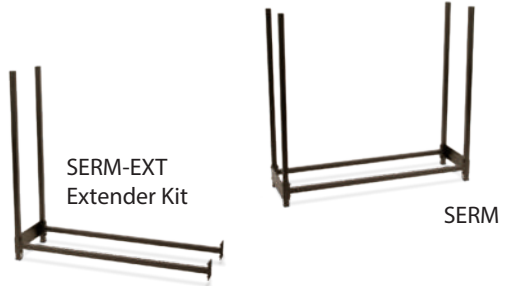

STOCK NO	SIZE (WxHxD) (IN INCHES)	APPROX LBS
SERM	48 x 45 x 13	15
SERM-EXT	48 x 45 x 13	12

Log Racks | Deluxe Log Rack Covers

STOCK NO	DESCRIPTION	SIZE (L x D x H) (IN INCHES)	APPROX. LBS.
SLRCD-S	Full Cover - Fits (SLRS) Log Rack	31 x 21 x 26	2.5
SLRCD-M	Full Cover - Fits (SLRM) Log Rack	48 x 21 x 38	4.5
SLRCD-XL	Full Cover - Fits (SLRXL) Log Rack	100 x 21 x 38	7.5

FEATURES

- Durable Woven Polyester Cloth Resists Fading and Cracking
- Protects Your Firewood from the Weather
- Keeps Wood Dry for Easier, Safer Burning
- Includes Metal Grommets to Easily Secure Cover
- Rust Resistant Zippers Allow for Easy Access



Log Racks | Log Caddy

STOCK NO	DESCRIPTION	SIZE (W x D x H) (IN INCHES)	APPROX. LBS.
SLCAD	Log Caddy - Wood Hauler	20.5 x 27 x 42	25
SLCAD-C	Log Caddy Cover	21 x 25 x 38	2

FEATURES

- Heavy Duty All-Steel Frame with Durable Powder Coat Finish
- Easy-Tilt Design with Pneumatic Tires Can Handle Stairs and the Toughest Terrain
- Slim Design Built to Go Through Door Frames. 14" Minimum Wood Length





FEATURES

- Patented Design Produces Unique Flame Pattern
- Secondary Combustion Minimizes Smoke



- Flame Genie Burns Easy-to-Handle Wood Pellets, Simple to Clean and Transport
- Flame Tower and Flame Cradle Burn any Brand Fire Log
- Constructed of Heavy Gauge Materials
- No Tools Required
- Made in the U.S.A.



STOCK NO	DESCRIPTION	SIZE (H x D) (IN INCHES)	APPROX. LBS.
FG-16	13" Wood Pellet Fire Pit - Black	12½ x 13½	13.5
FG-16-SS	13" Wood Pellet Fire Pit - Stainless Steel	12½ x 13½	14.5
FG-19	19" Inferno Wood Pellet Fire Pit - Black	16¼ x 19	23
FG-19-SS	19" Inferno Wood Pellet Fire Pit - Stainless Steel	16¼ x 19	24
FG-T	Wood Pellet Fire Pit Tote [Fits FG-16 & FG-16-SS]	15 x 17	1
FG-T19	Wood Pellet Fire Pit Tote [Fits FG-19 & FG-19-SS]	16½ x 21	1
FLT	Flame Tower - Black	27 x 13½	9
FLC	Flame Cradle - Black	8½ x 5¾ x 15½ [W]	4



FEATURES

- Universal Stake Caps Make Stakes Safer
- No Tools Required - Install Quickly and Easily
- Universal Design Fits All T-Posts, Small U-Posts, Tent Stakes, Rebar Sizes 2-6.

- Self-Locking and Reusable
- Reduces Injury from Unprotected Stakes
- Construction, Landscaping, Farm & Pet Uses
- Made in the U.S.A.

STOCK NO	DESCRIPTION	SIZE (H x D) (IN INCHES)	APPROX. LBS.
HSC06GR	HY-GUARD Stake Caps - 6 pk. Green	3½ x 2	.95
HSC06WH	HY-GUARD Stake Caps - 6 pk. White	3½ x 2	.95
HSC06OR	HY-GUARD Stake Caps - 6 pk. Orange	3½ x 2	.95



Hearth Accessories

Log Tote, Kettle, Creosote Control & Soot Eraser

STOCK NO	DESCRIPTION	SIZE (W x D x H) (IN INCHES)	APPROX. LBS.
SLT	Canvas Log Tote	29 x 11 x 12	2

FEATURES

- Durable, All Black Canvas Carrier with Enclosed Ends
- Reinforced Fabric Handles Wrap Under the Carrier for Complete Support
- Easily Loads/Unloads and Neatly Transports Firewood



STOCK NUMBER	SIZE	APPROX. LBS.
K25-BLK-P	2.5 Quarts	11
K50-BLK-P	5.0 Quarts	16

These Kettle Steamers may not be used for drinking water.



FEATURES

- Durable, Black Cast Iron Kettle Steamer
- Provides Beauty and Adds Humidity to Any Room
- Available in 2.5 & 5 Quart Sizes

STOCK NO	DESCRIPTION	APPROX. LBS.
ESF-1004-1	Creosote Control Brick - 4 Treatment Pack	4

FEATURES

- Helps Prevent Creosote Build-up
- Reduces Risk of Chimney Fires
- Contains no Waxes or Oils
- Made in the U.S.A.
- Made from Douglas Fir and Western Red Cedar
- Burns like Cordwood
- Safe for Use in All Wood Burning Appliances
- Complies with California Proposition 65



Use Completely Dry!

- No Scrubbing • No Mess
- No Solvents • No Cleanser
- 100% Natural Vulcanized Rubber
- Non-Toxic • Made in the U.S.A.

STOCK NO	DESCRIPTION	APPROX. LBS.
SE-1	Soot Eraser Single Pack	0.4

The "Soot Eraser" works like an eraser, absorbing smoke residue, soot, fly-ash and dirt. Works on most surfaces including:

- Brick
- Mantels
- Fireplace Hearth
- Woodwork
- Window Blinds
- Window Shades
- Most Wallpaper
- Painted Walls

Made in the U.S.A.

Hearth Accessories

Liberty Foundry Clean Out Door

STOCK NUMBER	SIZE (IN INCHES)	APPROX. LBS.
COD88	8 x 8	8



FEATURES

- Replaces Rusted or Broken Clean Out Doors, for Easy Access to Your Chimney
- Hinged with a Single-Bolt Closure
- Works for Indoor or Outdoor Clean Outs

Hearth Accessories

Firebacks

STOCK NUMBER	SIZE (IN INCHES)	APPROX. LBS.
FB1515	15 x 15	5
FB1618	16 x 18	6.5
FB2020	20 x 20	9
FB2424	24 x 24	12.5
FB2727	27 x 27	16



FEATURES

- Advantages of Stainless Steel Construction vs. Cast Iron:
 1. Lighter Weight = Easier Placement
 2. Less Expensive
- Slotted Base Allows for Adjustable Installation (65 - 90 degrees)
- Made in the U.S.A.

Hearth Accessories

SmokeGuard™

STOCK NUMBER	COLOR	HEIGHT (IN INCHES)	ADJUSTABLE WIDTH (IN INCHES)	APPROX. LBS.
FSG-BLK	BLACK	4	Fits 28 ½ to 48 Wide	5
FSG-BLK-6	BLACK	6	Fits 28 ½ to 48 Wide	6
FSG-BLK-8	BLACK	8	Fits 28 ½ to 48 Wide	7
FSG-BRS	BRASS	4	Fits 28 ½ to 48 Wide	5

Most fireplaces smoke because the opening is too high. SmokeGuard reduces the fireplace opening. It improves the draft and easily corrects the problem!

FEATURES

- Fixes Lazy Flues Due to Flue-to-Firebox Ratio Problems
- Black Powder Coat Finish (-BLK)
- Also Available in Plated Brass (-BRS)
- Spring Loaded for Easy Installation
- Heat Resistant Adhesive Caulk (included) Seals SmokeGuard in Position



Before



After

Made in the U.S.A.

GT SAF-T-GRATE® SERIES

Heavy duty self-feeding expandable fireplace grate. Saf-T-Grates are shipped knocked-down in a carton for easy storage.

STOCK NUMBER	APPROX. LBS.	WIDTH (IN INCHES)		DEPTH (IN INCHES)
		FRONT	BACK	
GT-18	22	18	14	12
GT-22	32	22 $\frac{3}{4}$	18	16
GT-30	40	30	26	16



GT-22

G500 SAMPSON SERIES

Heavy duty self-feeding expandable fireplace grate. Use the 8" G500-C to expand the width of any of the G500 grates. G500 grates are shipped knocked-down in a carton for easy storage. Patent #235412

STOCK NUMBER	APPROX. LBS.	WIDTH (IN INCHES)		DEPTH (IN INCHES)
		FRONT	BACK	
G500-20	22	20	16	16
G500-24	27	24	20	16
G500-28	33	28	24	16
G500-32	37	32	28	16
G500-36	41	36	32	16
G500-C	8	8	8	16



G500-24

G500-C Center Section

G SERIES FRANKLIN

One piece cast flat bottom style fireplace grate with 12" depth for use in small fireplaces and Franklin Stoves. Available with 2" or 4" cast-on legs.

STOCK NUMBER	APPROX. LBS.	HEIGHT (IN INCHES)	WIDTH (IN INCHES)		DEPTH (IN INCHES)
			FRONT	BACK	
G16	12	5	15 $\frac{1}{4}$	15 $\frac{1}{4}$	9
G17	15	5	17	12 $\frac{1}{2}$	12
G22	20	5 $\frac{1}{4}$	22	18 $\frac{1}{2}$	12
G27	22.5	5 $\frac{1}{4}$	27	22	12

Order with 4" cast-on leg by adding (-4) to models shown above.



G22
2" cast-on leg

G800 SERIES

One piece cast flat bottom style fireplace grate with cast on 4" legs.

STOCK NUMBER	APPROX. LBS.	HEIGHT (IN INCHES)	WIDTH (IN INCHES)		DEPTH (IN INCHES)
			FRONT	BACK	
G800-20	20	7	19 $\frac{1}{2}$	16	15
G800-24	23.5	7	24	20 $\frac{3}{4}$	15
G800-27	26	7	27	23 $\frac{1}{4}$	15



G800-24
4" cast-on leg

G1000 SERIES

One piece cast curved basket style fireplace grate with 2.5" removable legs.

STOCK NUMBER	APPROX. LBS.	WIDTH (IN INCHES)		DEPTH (IN INCHES)
		FRONT	BACK	
G1024	30	24 $\frac{1}{4}$	20	15 $\frac{1}{2}$
G1028	34	28 $\frac{1}{2}$	23 $\frac{1}{2}$	15 $\frac{1}{2}$

Also available with 4" removable legs by adding (-4) to models shown above.



G1024
2 $\frac{1}{2}$ " cast-on leg

All grate measurements are approximate and may vary slightly.

STOCK NO	DESCRIPTION	WIDTH (IN INCHES)		DEPTH (IN INCHES)	LEG HEIGHT (IN INCHES)	APPROX. LBS.
		FRONT	BACK			
G200-18	Steel Bar Grate - 4 bars	18	12	12	5	10
G200-24	Steel Bar Grate - 5 bars	24	21	15	5	15
G200-27	Steel Bar Grate - 6 bars	27	24	15	5	16
G200-30	Steel Bar Grate - 7 bars	30	27	15	5	20

FEATURES

- Heavy-duty 5/8" Solid Steel Bar Construction
- Black Finish
- Holds Firewood off the Fireplace Floor Allowing Air to Circulate
- Designed to Safely Contain Firewood
- No Assembly Required
- Ember Retainer Helps Keep Fire Hotter and Burn More Efficiently



FEATURES

- Clean and Contemporary Design
- Ember Protection Only (T1)
- 10-Gauge (3/16") Steel Hearth Protection
- Low Profile
- 1" Radius Corners
- No Thermal Protection
- Scratch Resistant Polyester Powder Coat Finish
- For Use with Heating Appliances Requiring Ember Protection Only
- Made in the USA



Standard Boards

STOCK NO	DESCRIPTION (IN INCHES)	A (IN INCHES)	B (IN INCHES)	WEIGHT (IN LBS)
EP3636B	Black Ember Protector 36 x 36	36	36	49.5
EP3648B	Black Ember Protector 36 x 48	36	48	67
EP4242B	Black Ember Protector 42 x 42	42	42	68.5
EP4848B	Black Ember Protector 48 x 48	48	48	89.5

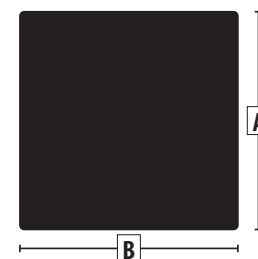

Corner Boards

STOCK NO	DESCRIPTION (IN INCHES)	A (IN INCHES)	B (IN INCHES)	C (IN INCHES)	WEIGHT (IN LBS)
EPC3636B	Black Ember Protector - Corner 36 x 36	36	30%	8	48.5
EPC4242B	Black Ember Protector - Corner 42 x 42	42	33½	12	67.5
EPC4848B	Black Ember Protector - Corner 48 x 48	48	37%	15	88

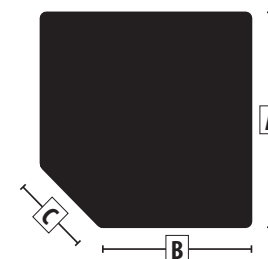

Hearth Extension

STOCK NO	DESCRIPTION (IN INCHES)	A (IN INCHES)	B (IN INCHES)	C (IN INCHES)	WEIGHT (IN LBS)
EP1848B	Black Ember Protector 18 x 48	18	48	12	33





FEATURES

- Provides Ember and Scratch Protection Only; Non-UL Provides No Thermal Protection
- Use Non-UL Stove Boards Under Heating Appliances not Requiring a Thermal Rating >1.0
- Non-UL Stove Boards May Not Be Used as Wall Shields
- Not for Outdoor Use

STOCK NUMBER	DESCRIPTION	CASE PACK	APPROX. LBS.
L2832BL-3	28 x 32 Lined - Black	3	22
L2832GT-3	28 x 32 Lined - Gray Slate Tile		
L2832ST-3	28 x 32 Lined - Sandstone Tile		
L2832WW-3	28 x 32 Lined - Woodgrain		
L3242BL-3	32 x 42 Lined - Black	3	31
L3242GT-3	32 x 42 Lined - Gray Slate Tile		
L3242ST-3	32 x 42 Lined - Sandstone Tile		
L3242WW-3	32 x 42 Lined - Woodgrain		
L3636BL-3	36 x 36 Lined - Black	3	32
L3636GT-3	36 x 36 Lined - Gray Slate Tile		
L3636ST-3	36 x 36 Lined - Sandstone Tile		
L3636WW-3	36 x 36 Lined - Woodgrain		
L3648BL-3	36 x 48 Lined - Black	3	42
L3648GT-3	36 x 48 Lined - Gray Slate Tile		
L3648ST-3	36 x 48 Lined - Sandstone Tile		
L3648WW-3	36 x 48 Lined - Woodgrain		
L3652BL-3	36 x 52 Lined - Black	3	45
L3652GT-3	36 x 52 Lined - Gray Slate Tile		
L3652ST-3	36 x 52 Lined - Sandstone Tile		
L3652WW-3	36 x 52 Lined - Woodgrain		

STOCK NUMBER	DESCRIPTION	APPROX. WEIGHT LBS.
ULSK	Wall Spacer Kit	.5
ULEG	UL Electrical Grounding Kit	.5
ULCK	Connector Kit	.5



ULSK



FEATURES

- Protect Your Floors from the Intense Heat, Hot Coals, Ashes and Soot that Wood Stoves can Produce
- Use a Type 2 Stove Board/Hearth Extender when Thermal Hearth Boards are Required with an R-Value <1.56
- Embossed Printed Steel and 1/2" Specially Formulated Backing Material - Non-Combustible Thermal Protection
- Stove Boards Tested to UL1618 May be Used as Wall Shields to Protect Your Walls from Heat
- R-Value = 1.56

STOCK NUMBER	DESCRIPTION	CASE PACK	APPROX. LBS.
T2UL1848BL-1	18 x 48 Type 2 UL-Compliant - Black	1	11
T2UL1848GT-1	18 x 48 Type 2 UL-Compliant - Gray Slate Tile		
T2UL2832BL-1	28 x 32 Type 2 UL-Compliant - Black	1	11
T2UL2832GT-1	28 x 32 Type 2 UL-Compliant - Gray Slate Tile		
T2UL2832ST-1	28 x 32 Type 2 UL-Compliant - Sandstone Tile		
T2UL2832WW-1	28 x 32 Type 2 UL-Compliant - Woodgrain		
T2UL3242BL-1	32 x 42 Type 2 UL-Compliant - Black	1	18
T2UL3242GT-1	32 x 42 Type 2 UL-Compliant - Gray Slate Tile		
T2UL3242ST-1	32 x 42 Type 2 UL-Compliant - Sandstone Tile		
T2UL3242WW-1	32 x 42 Type 2 UL-Compliant - Woodgrain		
T2UL3636BL-1	36 x 36 Type 2 UL-Compliant - Black	1	18
T2UL3636GT-1	36 x 36 Type 2 UL-Compliant - Gray Slate Tile		
T2UL3636ST-1	36 x 36 Type 2 UL-Compliant - Sandstone Tile		
T2UL3636WW-1	36 x 36 Type 2 UL-Compliant - Woodgrain		
T2UL3648BL-1	36 x 48 Type 2 UL-Compliant - Black	1	23
T2UL3648GT-1	36 x 48 Type 2 UL-Compliant - Gray Slate Tile		
T2UL3648ST-1	36 x 48 Type 2 UL-Compliant - Sandstone Tile		
T2UL3648WW-1	36 x 48 Type 2 UL-Compliant - Woodgrain		
T2UL3652BL-1	36 x 52 Type 2 UL-Compliant - Black	1	25
T2UL3652GT-1	36 x 52 Type 2 UL-Compliant - Gray Slate Tile		
T2UL3652ST-1	36 x 52 Type 2 UL-Compliant - Sandstone Tile		
T2UL3652WW-1	36 x 52 Type 2 UL-Compliant - Woodgrain		
T2UL4048BL-1	40 x 48 Type 2 UL-Compliant - Black	1	28
T2UL4848BL-1	48 x 48 Type 2 UL-Compliant - Black	1	31



New! Gardus Rotary Cleaning Systems Attach to a Cordless Drill to Effectively Clean Hard to Reach Ducts

The LintEater® is the most valuable tool one can own for ensuring the safe operation of your clothes dryer. Easy to use with a cordless drill. Provides a means for thorough cleaning of your entire dryer vent system.

LINTEATER PRO ROTARY DRYER VENT CLEANING SYSTEM | RLE208



1 - Self-feeding 4" Auger Brush



4 - 36" Long Flexible rods "Button-Link" Quick Connect System



1 - Blockage Removal Tool



1 - Large 2.5" dia. Lint Brush



1 - Vacuum Adapter



1 - Dryer Adapter

LINTEATER ROTARY DRYER VENT CLEANING SYSTEM | RLE202



1 - Self-feeding 4" Auger Brush



4 - 36" Long Flexible Rods with Screw Connect System



1 - Blockage Removal Tool



LintCatcher for trapping lint while cleaning.



1 - Large 2.5" dia. Lint Brush



1 - Vacuum Adapter



1 - Dryer Adapter

STOCK NO	DESCRIPTION	SIZE (L x D x H) (IN INCHES)	APPROX. LBS.
RLE208	LintEater Pro Rotary Dryer Vent Cleaning System	5 x 3.5 x 37	1.5
RJR103	LintEater Pro Jr. Rotary Dryer Vent Cleaning Kit	6 x 3 x 20.5	.5
RLE202	LintEater Rotary Dryer Vent Cleaning System	5 x 3.5 x 37	1.5
RJR601	LintEater Jr. Rotary Dryer Vent Cleaning Kit	6 x 3 x 20.5	.5
R4203613	LintCatcher - Lint Collection Bag	6 x .75 x 9	.1
R3203612	12' Extension Kit for RLE202 & RJR601	2 x .5 x 38	.85
PRD303	9' Extension Kit for RLE208 & RJR103	2 x .5 x 38	.5

Made in the U.S.A.



LintEater Pro Jr. | RJR103

For shorter vents. Includes two 18" rods with "Button-Link" Quick Connect system.

LintEater Jr. | RJR601

For shorter vents. Includes two 18" rods with Screw Connect System.



SOOTEATER ROTARY CHIMNEY CLEANING SYSTEM RCH205-B

FEATURES

- Helps Prevent Flue Fires!
- Unique "Trim-to-Fit" Design Cleans Multiple Flue Sizes and Shapes (Round-Square-Rectangle-Oval)
- Works with Any Cordless Drill
- Won't Scratch Metal Flues Like Steel Brushes
- Fits through Tight Areas
- Replaceable Whip Line
- Spins "Forward" and "Reverse"



6 - 3' Long Flexible Rods, 1 - Trim-to-Fit Spinning Chimney Whip, 1 - Drill Adapter, 1 - Hex Key



"Button-Link" Quick Connect System



6 - 3' Long Flexible Rods (16mm Polypropylene)



1 - Trim-to-Fit Spinning Chimney Whip

STOCK NO	DESCRIPTION	SIZE (H x D) (IN INCHES)	APPROX. LBS.
RCH205-B	SootEater Rotary Chimney Cleaning System	5 x 3 x 38	3
CRD307	6' Extension Kit for RCH205-B	2.5 x 1 x 38	.75
RCWL209	Replacement Whip Line for RCH205-B	8 x .5 x 10	.1
CWH208	Replacement Head w/ Whip Line for RCH205-B	6 x 3 x 19	.25

Made in the U.S.A.



FEATURES

- Helps Prevent Flue Fires!
- Unique "Trim-to-Fit" Design Cleans Multiple Flue Sizes and Shapes (Round-Square-Rectangle-Oval)
- Works with Any Cordless Drill
- Won't Scratch Metal Flues Like Steel Brushes
- Fits through Tight Areas
- Replaceable Whip Line
- Spins "Forward" and "Reverse"

SOOTEATER ROTARY CHIMNEY LINER CLEANING SYSTEM | SLK-24



8 - 3' Long Flexible Rods, 1 - Trim-to-Fit Spinning Chimney Whip, 1 - Drill Adapter, 1 - Hex Key



"Button-Link" Quick Connect System



8 - 3' Long Flexible Rods (12mm Solid Nylon)



1 - Trim-to-Fit Spinning Chimney Whip

STOCK NO	DESCRIPTION	SIZE (H x D) (IN INCHES)	APPROX. LBS.
SLK-24	SootEater Rotary Chimney Liner Cleaning System	5 x 3 x 38	2.5
LKR203	6' Extension Kit for SLK-24	2 x .5 x 38	.5

SOOTEATER ROTARY PELLET STOVE CLEANING SYSTEM | RPS204-B



3 - 3' Long Flexible Rods, 1 - 3" Propeller Brush, 1 - 4" Propeller Brush, 1 - Long Reach Cleaning Brush with Scraper



Screw-Connect System



1 - 3" Propeller Brush



1 - 4" Propeller Brush

STOCK NO	DESCRIPTION	SIZE (H x D) (IN INCHES)	APPROX. LBS.
RPS204-B	SootEater Rotary Pellet Stove Cleaning System	37 x 2.5	1.5
PRD308	6' Extension Kit for RPS204-B	36 x 1	.5

GutterSweep

New! Gardus Rotary Cleaning Systems offer an easy way to handle gutter maintenance without stepping foot on a ladder!



BEFORE GutterSweep



FEATURES

- Power the GutterSweep Rotary Paddle with Your Cordless Drill
- Flush Your Gutters -- Connect GutterSweep to Your Garden Hose and Attach the Water Jet Brush or Water Jet Scoop
- Up to 12' Reach for Single Story Gutters
- Designed for Periodic Gutter Maintenance Safely from the Ground



GutterSweep Components



2 - 3' Rotary Drive Extension Poles



2 - 3' Rotary Drive Extension Poles, 1 - Curved Tube with Flex Drive, 1 - Drill Adapter



AFTER GutterSweep



1 - Gutter Brush with Water Jet Nozzle



1 - Rotary Paddle Brush



1 - Gutter Scoop with Water Jet

STOCK NO	DESCRIPTION	SIZE (L x D x H) (IN INCHES)	APPROX. LBS.
GS900	GutterSweep Rotary Gutter Cleaning System	6.5 x 4.5 x 40	5.2
GSX906	6' Extension Kit for GS900	4.5 x 2 x 40.5	2.2

Made in the U.S.A.



FEATURES

- 7-Ply 3/16" Stainless Steel for Superior Strength and Durability
- Rugged 10-Groove Construction Allows for Expansion and Contraction
- Reduces Creosote Build-up in the Chimney
- Limited Lifetime Warranty



FEATURES

- ShelterPro Chimney is Designed to Handle Temperatures up to 2100°F with Superior Durability and Safety
- Inner Liner and Outer Casing are Both Grade 304 Stainless Steel, Designed to Prevent Corrosion and Keep out Moisture
- Premium Fiber Insulation Ensures Minimal Loss of Heat
- Offered in 6" and 8" Diameters and a Variety of Lengths
- Lifetime Warranty

STOCK NO	DESCRIPTION	FUEL	SIZE (H x W x D) (IN INCHES)	APPROX. LBS
MH-6R	6" Bottom Crimp	Wood or Coal	18 ¼ x 10 ⅝ x 14 ¼	28
MH-7R	7" Bottom Crimp	Wood or Coal	18 ¼ x 10 ⅝ x 14 ¼	28
MH-8R	8" Bottom Crimp	Wood or Coal	18 ¼ x 10 ⅝ x 14 ¼	28
MH-6	6" Top Crimp	Oil	18 ¼ x 10 ⅝ x 14 ¼	28
MH-7	7" Top Crimp	Oil	18 ¼ x 10 ⅝ x 14 ¼	28
MH-8	8" Top Crimp	Oil	18 ¼ x 10 ⅝ x 14 ¼	28
MH-6G	6" Gas/Top Crimp	NG Only	18 ¼ x 10 ⅝ x 14 ¼	28
MH-7G	7" Gas/Top Crimp	NG Only	18 ¼ x 10 ⅝ x 14 ¼	28
MH-8G	8" Gas/Top Crimp	NG Only	18 ¼ x 10 ⅝ x 14 ¼	28



FEATURES

- Magic Heat Will Reclaim up to 30% of Lost Heat from a Stove and Distribute it into the Home
- UL Approved
- 10 Heat Exchanger Tubes
- Requires Standard Outlet
- Designed for use with all Types of Heating Equipment with Inside Flue Temps Exceeding 350°F/177°C, Skin Temps of 250°F/121°C
- Can use Thermostatic Control or Manual On/Off
- HY-C's 1-Year Limited Warranty
- Thermostat Control Mode; ON at 150°F/66°C, OFF at 120°F/44°C
- BTU Output Variable: 8000 BTU minimum - 30,000 maximum
- Gas Models for Natural Gas (NG) Only
- Fan 8"; 225 CFM Motor 120 V/60 Hz



STOCK NO	DESCRIPTION	DIMENSIONS (W x D x H) (IN INCHES)	MAXIMUM HEATING (SQ. FT.)	WEIGHT (IN LBS)	SHIPPING WEIGHT (IN LBS)
FC1000	EPA Certified FC1000 Wood Burning Indoor Furnace	25 3/4" x 45 1/2" x 42"	up to 2,500 sq. ft.	435	480
FC1500	EPA Certified FC1500 Wood Burning Indoor Furnace	25 3/4" x 44 1/2" x 52 1/2"	up to 3,000 sq. ft.	575	620
FC1700	EPA Certified FC1700 Wood Burning Indoor Furnace	25 3/4" x 50 1/4" x 52 1/2"	up to 4,000 sq. ft.	635	680
FC1900	EPA Certified FC1900 Wood Burning Outdoor Furnace	29 1/2" x 58" x 55"	up to 4,000 sq. ft.	755	800

FC1000 FEATURES

- EPA Certified
- Whole Home Heating Solution
- Clean Burn Technology
- Extended Burn Time [Up to 10 Hours]
- 4.0 cu. ft. Firebox
- Stainless Steel Lined Firebox
- Accepts 20" Logs
- Maximum 130,000 BTUs Output
- Digital Thermostat w/ 50cfm Draft Blower
- High Capacity 1500 CFM Blower
- Fixed Grate System with Removable Ash Bin
- Pre-Wired Electrical Components
- Low Clearance to Combustibles: Side: 6" Back: 12"
- Standard 6" Chimney Connection
- Standard 8" Air Duct Connections
- Fire Chief Furnace Installation Video
- Made in the USA
- Limited Lifetime Firebox and Grate Warranty, 2-Year Distribution Blower Warranty, 1-Year Electrical Components Warranty

FC1500, FC1700, FC1900 FEATURES

- EPA Certified
- Whole Home Heating Solution
- Extended Burn Time [Up to 12 Hours]
- Clean Burn Technology
- Firebox CF: FC1500 - 4.1cf; FC1700/FC1900 - 5.7cf
- Stainless Steel Lined Firebox
- Accepts 20" Logs [FC1500]; Accepts 26" Logs [FC1700 & FC1900]
- Maximum 150,000 BTUs Output [FC1500]; Maximum 170,000 BTUs Output [FC1700 & FC1900]
- Digital Thermostat w/ 50cfm Draft Blower
- High Capacity 1800 CFM Blower
- 360° Cast Iron Roller Grate System with Easy Ash Removal
- Pre-Wired Electrical Components
- Integrated Legs Providing Higher Loading Door
- Low Clearance to Combustibles: Side: 6" Back: 12"
- Standard 6" Chimney Connection
- Standard 8" Air Duct Connections [10" & 12" for FC1900]
- Fire Chief Furnace Installation Video
- Made in the USA
- Limited Lifetime Firebox and Grate Warranty, 2-Year Distribution Blower Warranty, 1-Year Electrical Components Warranty



HOME SOLUTIONS BUILT BETTER