

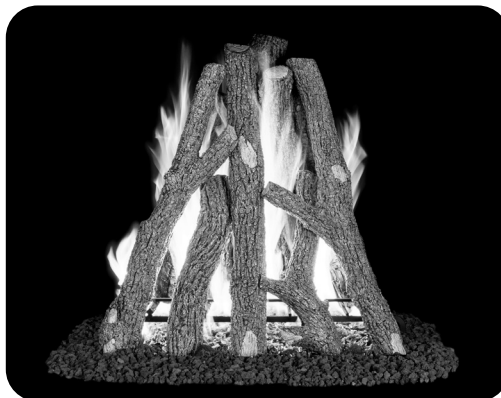

Burner Systems:

- GR47- ** (P)A
- GR47- ** -02(M)(P)
- GR47- ** -17(M)(P)

****Sizes:**
(18/20, 24/30)



Regulated burner system for use w/ propane or natural gas

DESIGN CERTIFIED
to
Vented Decorative Appliance
ANSI Z21.60
CSA 2.26

FOR INSTALLATION IN SOLID-FUEL BURNING FIREPLACES*

GR47 RUMFORD VENTED GAS LOG SETS

WARNING

If the information in this manual is not followed exactly, a fire or explosion may result, causing property damage, personal injury, or loss of life.

Do not store or use gasoline or other flammable vapors and liquids in the vicinity of this or any other appliance.

WHAT TO DO IF YOU SMELL GAS:

- Open a window.
- Do not try to light any appliance.
- Do not touch any electrical switch; do not use any phone in the building.
- Immediately call the gas supplier from a neighbor's phone. Follow gas supplier's instructions.
- If you cannot reach the gas supplier, call the fire department.

Installation and service must be performed by a qualified professional service technician, service agency, or the gas supplier.

This appliance is only for use with the type of gas indicated on the rating plate.

IMPORTANT: READ THESE INSTRUCTIONS CAREFULLY BEFORE STARTING INSTALLATION OF THE UNIT.

This gas log set is to be installed only in a solid-fuel burning fireplace with a working flue and constructed of noncombustible material. The installation, including provisions for combustion and ventilation air must conform with the *National Fuel Gas Code, ANSI Z223.1/ NFPA 54*, or the *CSA B149.1, Natural Gas and Propane Installation Code*, and applicable local building codes.

A damper clamp, which must be permanently installed, is included to maintain the minimum permanent vent opening and to prevent full closure of the damper.

The chimney damper MUST be fully opened when burning the unit. The unit is designed to burn with yellow flames; thus adequate ventilation is absolutely necessary.

To comply with certification, listings, and building code acceptances, and for safe operation and proper performance of this gas log set, you must use ONLY Peterson Real Fyre parts, decorative media, and accessories. Use of any other controls, parts, or accessories not designed for use with Real Fyre gas log sets is prohibited. This will void all warranties, certifications, listings, and building code approvals, and may cause property damage, personal injury, or loss of life. Peterson will not be liable for any damages caused by this misuse.

***Note:** Solid-fuels shall not be burned in a fireplace where this product is installed.



We recommend that our gas hearth products be installed and serviced by professionals who are certified in the U.S. by the National Fireplace Institute® (NFI) as NFI Gas Specialists.

INSTALLER:
Leave this manual with the appliance.
CONSUMER:
Retain this manual for future reference.



Systèmes de brûleur:

GR47- ** (P)A
 GR47- ** -02(M)(P)
 GR47- ** -17(M)(P)

**Tailles:
 (18/20, 24/30)

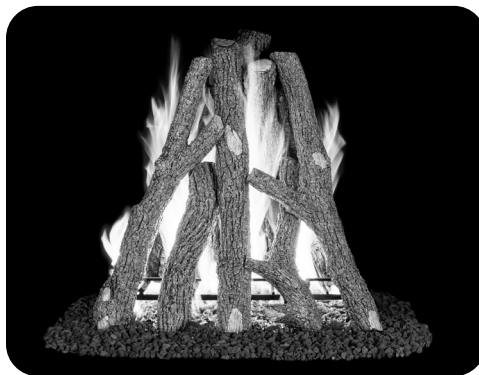

CONCEPTION CERTIFIÉE
 à
 Vented Decorative Appliance
 ANSI Z21.60
 CSA 2.26

**POUR L'INSTALLATION DANS
 LE COMBUSTIBLE SOLIDE DE
 BRÛLANT FIREPLACES***

Système de brûleur réglementé
 l'usage du propane ou du gaz naturel

GR47 RUMFORD VENTILÉ SYSTÈMES DE BRÛLEURS

AVERTISSEMENT

Si l'information en ce manuel n'est pas suivie exactement, une incendie ou une explosion peut résulter, entraînant des dégâts matériels, des blessures, ou la perte de la vie.

Ne stockez pas ou n'employez pas l'essence ou d'autres vapeurs et liquides inflammables à proximité de ceci ou d'aucun autre appareil.

CE QUI À FAIRE SI VOUS SENTEZ LE GAZ:

- Ouvrez une fenêtre.
- N'essayez pas de n'allumer aucun appareil.
- Ne touchez aucun commutateur électrique; n'utilisez aucun téléphone dans le bâtiment.
- Appelez immédiatement le fournisseur de gaz du téléphone du voisin. Suivez les instructions du fournisseur de gaz.
- Si vous ne pouvez pas atteindre le fournisseur de gaz, appelez le département de feu.

Installation et entretien doivent être effectués par un technicien professionnel qualifié de service, un organisme de service ou le fournisseur de gaz.

Cet appareil sert seulement avec le type de gaz indiqué de la plaque de contrôle.

INSTALLATEUR :

Laissez ce manuel avec l'appareil.

CONSOMMATEUR:

Maintenez ce manuel pour la future référence.



**IMPORTANT: LISEZ CES INSTRUCTIONS
 SOIGNEUSEMENT AVANT DE
 COMMENCER L'INSTALLATION DE
 L'UNITÉ.**

Le Real Fyre système de brûleur doit être installé seulement dans une cheminée brûlante de combustible solide avec une conduite de cheminée fonctionnante et être construit avec du matériel non-combustible. L'installation, y compris des dispositions pour l'air de combustion et de ventilation doit se conformer au code national de gaz de carburant, la norme ANSI Z223.1/ NFPA 54, ou le CSA B149.1, code d'installation de gaz naturel et de propane, et codes du bâtiment locaux applicables.

Une bride plus humide est incluse pour maintenir l'ouverture permanente minimum de passage et pour empêcher la pleine fermeture de la lame plus humide. **L'amortisseur de cheminée DOIT être entièrement ouvert en brûlant l'unité. L'unité est conçue pour brûler avec les flammes jaunes; ainsi à ventilation proportionnée est absolument nécessaire.**

Pour être en conformité avec la certification, les listes et les acceptations du code du bâtiment, ainsi que pour un fonctionnement en toute sécurité et des performances correctes, vous devez utiliser UNIQUEMENT les pièces, les supports de décoration et les accessoires Peterson Real Fyre. L'utilisation d'autres contrôles, de pièces ou accessoires non conçu pour une utilisation avec les systèmes de brûleurs Real Fyre est interdite. Ceci annulera toutes les garanties, les certifications, les annonces et les approbations du code du bâtiment, et peut causer des dommages matériels, des blessures ou des pertes de vie. Peterson ne sera pas responsable des dommages causés par ce détournement.

***Note:** des Plein-carburants ne seront pas brûlés dans une cheminée où un appareil décoratif est installé.

TABLE OF CONTENTS

GETTING STARTED

IMPORTANT PRE-INSTALLATION AND FIREPLACE SAFETY INFORMATION	5
FIREPLACE OPERATING SAFETY INFORMATION	7
SPECIFICATIONS.....	8
DAMPER CLAMP INSTRUCTIONS	11
GR47 BURNER PARTS LIST - MANUAL (A) SERIES...	12
GR47 BURNER PARTS LIST - 02 SERIES.....	13
GR47 BURNER PARTS LIST - 17 SERIES.....	14

INSTALLATION

INSTALLATION	15
<i>INSTALL BURNER</i>	15
<i>INSTALL BATTERIES (if applicable)</i>	15
<i>INSTALL REMOTE RECEIVER / SWITCH BOX (if applicable)</i>	16
<i>PLACE WIRE GUARD (if applicable)</i>	16
<i>PREPARE GRATE AND CENTER</i>	17
<i>HEAT SHIELD PLACEMENT</i>	18
<i>LIGHTING TEST</i>	18
<i>LAVA GRANULES/COALS (optional)</i>	18
<i>SAND/VERMICULITE PLACEMENT</i>	19
<i>BLACK EMBERS PLACEMENT</i>	19
<i>GRATE PLACEMENT</i>	20
<i>LOG SET PLACEMENT</i>	22
INSTALLING/REPLACING BATTERIES (if applicable).....	23
<i>REMOTE TRANSMITTER BATTERY</i>	23
<i>RECEIVER/BURNER SYSTEM BATTERIES</i>	23
NOTES PAGE	24

USE, CARE, & SERVICE

LIGHTING INSTRUCTIONS - MANUAL (A) SERIES...	25
<i>FOR YOUR SAFETY, READ BEFORE LIGHTING</i>	25
<i>LIGHTING THE PILOT</i>	25
<i>LIGHTING THE BURNER</i>	27
<i>SHUTTING DOWN</i>	27
<i>PILOT BURNER CHECK/ADJUSTMENT</i>	27
LIGHTING INSTRUCTIONS - 02 SERIES.....	29
<i>FOR YOUR SAFETY, READ BEFORE LIGHTING</i>	29
<i>REMOTE LIGHTING (if equipped)</i>	29
<i>MANUAL LIGHTING</i>	31
<i>SHUTTING DOWN</i>	31
LIGHTING INSTRUCTIONS - 17 SERIES.....	33
<i>FOR YOUR SAFETY, READ BEFORE LIGHTING</i>	33
<i>LIGHTING THE PILOT</i>	33
<i>REMOTE LIGHTING (if equipped)</i>	33
<i>MANUAL LIGHTING</i>	35
<i>SHUTTING DOWN</i>	37
<i>PILOT BURNER CHECK/ADJUSTMENT</i>	37
REMOTE OPERATING INSTRUCTIONS - 17 SERIES ..	37
<i>ORIENTATION</i>	37
<i>FLAME HEIGHT</i>	37
CLEANING AND SERVICING.....	39
<i>SYNCING THE REMOTE SYSTEM (if applicable)</i>	40
FLAME DESCRIPTION	40
TROUBLESHOOTING.....	41
ELECTRONIC PILOT TROUBLESHOOTING (IF APPLICABLE).....	43
WARRANTY	44

L'INFORMATION DE SÛRETÉ IMPORTANTE DE PRÉINSTALLATION ET DE CHEMINÉE

ATTENTION: L'installation et la réparation doivent être faites par un NFI certifié ou tout autre installateur professionnel qualifié.

Installateur: Lisez soigneusement ces instructions avant d'installer ce système de brûleur à gaz. Soyez sûr que vous comprenez tous les mesures de sécurité et avertissements contenus en ce manuel.

- A. FAITES ATTENTION: Sinon installé, entretenu, et utilisé correctement par ces instructions, ce produit peut causer le dommage corporel, les dégâts matériels, ou les pertes humaines sérieux.**
- B. AVERTISSEMENT:** Quand l'installation dans une cheminée plein-carburant-brûlante, la conduite de cheminée, l'amortisseur, et le foyer de cheminée doivent ÊTRE COMPLÈTEMENT NETTOYÉS de la suie, de la créosote, des cendres, et de la peinture lâche, et doivent être inspectés par un décapant qualifié de cheminée. Quelques cheminées plus anciennes peuvent ont besoin de réparation avant d'installer cet appareil.
- C.** Le plancher du foyer doit être plat et lisse.
- D.** Cet appareil sert seulement avec le type de gaz indiqué de la plaque de contrôle. Cet appareil n'est pas CONVERTIBLE de CHAMP pour l'usage avec d'autres gaz.
VÉRIFIEZ LE TYPE de GAZ (normal ou propane) : La fourniture de gaz doit être identique qu'indiquée de votre plaque de contrôle de système de brûleur. Si la fourniture de gaz est différente, **N'INSTALLEZ PAS**. Contactez votre revendeur pour l'aide immédiate.
- E.** LA PRESSION DE GAZ INSUFFISANTE GARDERA LE PILOTE DU FONCTIONNEMENT CORRECTEMENT (SI ÉQUIPÉ). N'EMPLOYEZ PAS SI LA PRESSION DE GAZ EST INFÉRIEURE À LA CONDITION MINIMUM.
- F.** L'admission minimum gaz-fournissent la pression aux fins de l'ajustement d'entrée est 5" ; colonne d'eau (w.c.) sur le gaz naturel et le 11" ; w.c. sur le gaz de propane. La pression de gaz insuffisante affectera l'opération appropriée du pilote (si équipé). N'installez pas cet appareil à gaz si la pression minimum n'est pas disponible. L'admission maximum gaz-fournissent la pression est 10.5" ; w.c. sur le gaz naturel et le 13" ; w.c. sur le gaz de propane. La source de propane doit être réglée. **(Ne branchez pas cet appareil directement à un réservoir de gaz propane non réglementée - cela peut provoquer une explosion.) Ne branchez pas cet appareil à une bouteille de gaz propane portable.**
- G.** **Le système sifflant de gaz doit être classé pour fournir la pression d'admission minimum au débit maximum (BTU/hr).** La perte de pression anormale se produira si la pipe est trop petite, ou la course est trop longue. La pipe de fourniture de gaz doit être 1/2" ; diamètre intérieur minimum. Si la ligne de gaz est plus longue que 20' ; une ligne de plus grand diamètre peut être nécessaire. Reportez-vous aux directives NFPA 54 pour plus de détails.
- H.** Les estimations d'entrée montrées en Btu par heure sont pour des altitudes jusqu'à 2.000 pi. Pour des altitudes au-dessus de 2.000 pi, référez-vous au code national de gaz de carburant ou entrez en contact avec le fabricant avant d'installer ce produit.
- I.** Cet appareil à gaz et son clapet à gaz principal doivent être disconnected du gaz-fournissent le système sifflant pendant tout vérificateur de pression de ce système aux pressions d'essai au-dessus de 1/2 psig.
- J.** Cet appareil à gaz doit être isolé dans gaz-fournissent le système sifflant en fermant le robinet d'isolement d'équipement relié au gaz-fournissent la ligne pendant tout vérificateur de pression du gaz-fournissent le système sifflant aux pressions d'essai égales à ou moins d'à 1/2 psig.
- K.** **Pour installer l'appareil à gaz dans votre foyer, le foyer doit satisfaire aux exigences minimales de taille (voir le tableau des spécifications du produit dans la section SPÉCIFICATIONS).**
- L.** Cet appareil peut être installé dans un marché des accessoires, maison (mobile) de manière permanente située et manufacturée, où non interdit par des codes locaux. L'installation des appareils a conçu pour la maison manufacturée (États-Unis seulement) ou installation de caravane résidentielle doit se conformer au CAN/CSA standard Z240 MH, logement mobile, au Canada, ou à la construction et au standard de sécurité à la maison manufacturés, intitulent 24 CFR, la partie 3280, aux Etats-Unis, ou quand une telle norme ne s'applique pas, à ANSI/NCSBCS A225.1/NFPA 501A, installations à la maison manufacturées standard.
- M.** **NE PAS installer ce système de brûleur dans un foyer avec une lèvre en cendres ou un renforcement supérieur à 3/4".**
- N.** Si ce système de brûleur est installé dans un foyer avec **des portes en verre** et que les portes ont un cadre qui obstrue le flux d'air vers le sol du foyer, celui-ci DOIT comporter des fentes (au-dessus du sol du foyer) permettant une ventilation adéquate. L'ouverture (avec les portes complètement ouvertes) DOIT respecter les exigences minimales de largeur et de hauteur de la cheminée. Les portes en verre DOIVENT être complètement ouvertes lorsque le brûleur est en marche. Voir la section SPÉCIFICATIONS pour plus de détails.

IMPORTANT PRE-INSTALLATION AND FIREPLACE SAFETY INFORMATION

CAUTION: Installation and repair must be done by an NFI Certified or other qualified professional installer.

Installer: Carefully read these instructions before installing this gas burner system. Be sure you understand all safety precautions and warnings contained in this manual.

- A. BE CAREFUL:** If not installed, serviced, and used correctly per these instructions, this product can cause serious personal injury, property damage, or loss of life.
- B. WARNING:** When installing in a solid-fuel-burning fireplace, the chimney flue, damper, and firebox must be thoroughly CLEANED of soot, creosote, ashes, and loose paint, and must be inspected by a qualified chimney cleaner. Some older fireplaces may need repair prior to installing this appliance.
- C.** The fireplace floor must be level and smooth.
- D.** This appliance is only for use with the type of gas indicated on the rating plate. This appliance is **NOT FIELD CONVERTIBLE** for use with other gasses.
CHECK GAS TYPE (natural or L.P.): The gas supply must be the same as stated on your burner system rating plate. If gas supply is different, **DO NOT INSTALL**. Contact your dealer for immediate assistance.
- E.** INSUFFICIENT GAS PRESSURE WILL KEEP THE PILOT (IF EQUIPPED) FROM OPERATING PROPERLY. DO NOT USE IF GAS PRESSURE IS LOWER THAN THE MINIMUM REQUIREMENT.
- F.** The *minimum* inlet gas-supply pressure for purposes of input adjustment is **5"** water column (w.c.) on **natural gas** and **11"** w.c. on **L.P. gas**. Insufficient gas pressure will affect proper operation of the pilot (if equipped). Do not install this gas appliance if minimum pressure is not available. The *maximum* inlet gas-supply pressure is **10.5"** w.c. on natural gas and **13"** w.c. on L.P. gas. The L.P. source must be regulated. **(Do not connect this appliance directly to an unregulated L.P. gas tank - this can cause an explosion.) Do not connect this appliance to a portable L.P. gas cylinder.**
- G.** **The gas piping system must be sized to provide minimum inlet pressure at the maximum flow rate (BTU/hr).** Undue pressure loss will occur if the pipe is too small, or the run is too long. Gas supply pipe must be 1/2" minimum interior diameter. If the gas line is longer than 20', a larger diameter line may be necessary. Refer to the NFPA 54 guidelines for further details.
- H.** Input ratings shown in BTU per hour are for elevations up to 2,000 ft. For elevations above 2,000 ft., refer to the National Fuel Gas Code or contact manufacturer before installing this product.
- I.** This gas appliance and its main gas valve must be disconnected from the gas-supply piping system during any pressure testing of that system at test pressures in excess of 1/2 psig.
- J.** This gas appliance must be isolated from the gas-supply piping system by closing the equipment shutoff valve connected to the gas-supply line during any pressure testing of the gas-supply piping system at test pressures equal to or less than 1/2 psig.
- K.** **To install the gas appliance in your fireplace, the fireplace MUST meet the minimum size requirements (see product specifications table in SPECIFICATIONS section).**
- L.** This appliance may be installed in an aftermarket, permanently located, manufactured (mobile) home, where not prohibited by local codes. Installation of appliances designed for manufactured home (U.S. only) or mobile home installation must conform with the Standard *CAN/CSA Z240 MH, Mobile Housing*, in Canada, or with the *Manufactured Home Construction and Safety Standard, Title 24 CFR, Part 3280*, in the United States, or when such a standard is not applicable, *ANSI/NCSBCS A225.1/NFPA 501A, Manufactured Home Installations Standard*.
- M.** **DO NOT install this burner system in a fireplace with an ash lip or recess greater than 3/4".**
- N.** If this burner system is installed in a fireplace with **glass doors**, and the doors have a frame that obstructs airflow to the fireplace floor, the frame **MUST** have slots (above the fireplace floor) that allow adequate ventilation. The opening (with doors fully open) **MUST** meet the minimum fireplace size front width and height requirements. The glass doors **MUST** be fully open when the burner is in operation. See the SPECIFICATIONS section for details.

INFORMATIONS SUR LA SÉCURITÉ D'EXPLOITATION DE CHEMINÉE

- A. Adultes doivent être présents lors de cet appareil au gaz est en marche. Cette unité ne doit pas être laissée sans surveillance ou brûlure lorsque tout quelqu'un dort.
- B. Gardez le domaine du clair réglé de notation de gaz et libérez des matériaux combustibles, l'essence, et d'autres vapeurs et liquides inflammables.
- C. Ne pas utiliser cet appareil si une partie quelconque a été submergée. Appelez immédiatement un technicien de service qualifié pour inspecter l'appareil et pour remplacer toute pièce du système de contrôle et toute commande de gaz qui a été sous l'eau. Tentative d'opération peut entraîner un incendie ou une explosion entraînant des dommages matériels, des blessures ou des pertes de vie.
- D. **Un écran de cheminée doit être en place lorsque le système brûle.** Des dispositions pour un air de combustion adéquat doivent être maintenues. Sauf si d'autres dispositions pour l'air de combustion sont prévues, l'écran aura une ouverture pour l'introduction d'air de combustion. L'air de combustion est adéquat lorsque toutes les flammes sont enroulées dans le foyer et loin de l'écran. **Lorsque vous utilisez un foyer (porte) en verre, les portes en verre DOIVENT être complètement ouvertes lorsque le brûleur est en marche.**
- E. Ne retirez pas les plaques signalétiques ou les étiquettes d'avertissement. Ceux-ci sont une composante de sécurité et d'identification intégrante de cet appareil.
- F. Assurez-vous de lire la section de nettoyage et l'entretien et la section de description de la flamme.

FIREPLACE OPERATING SAFETY INFORMATION

- A. Adults shall be present when this gas appliance is operating. This unit shall not be left burning when unattended or while anyone is sleeping.
- B. Keep the area of the gas burner system clear and free from combustible materials, gasoline, and other flammable vapors and liquids.
- C. DO NOT use this appliance if any part has been underwater. Immediately call a qualified service technician to inspect the appliance and to replace any part of the control system and any gas control that has been underwater. Attempted operation may result in fire or explosion resulting in property damage, personal injury or loss of life.
- D. **A fireplace screen must be in place when the system is burning.** Provisions for adequate combustion air must be maintained. Unless other provisions for combustion air are provided, the screen shall have an opening(s) for introduction of combustion air. Combustion air is adequate when all flames curl into the fireplace and away from the screen. **When a glass fireplace enclosure (door) is used, the glass doors MUST be fully open when the burner is in operation.**
- E. Do not remove the rating plates or the warning tags. These are an integral safety and identification component of this appliance.
- F. Be sure to read the CLEANING AND SERVICING and FLAME DESCRIPTION sections.

SPECIFICATIONS

Real Fyre gas burner systems must be installed only in a solid-fuel burning fireplace with the minimum firebox dimensions and venting requirements met (see following tables). This appliance is designed to burn with yellow flames; adequate ventilation is absolutely necessary.

Product Specifications

Model	Minimum Fireplace Size				BTU Rating	
	Width *		Depth ‡	Height	Nat. Gas	L.P. Gas
	Front	Rear †				
GR47-18/20	34"	26"	17"	32"	75k	60k
GR47-24/30	40"	32"	17"	36"	95k	80k
Important Information Regarding Dimensions						
* For 02 models, add 2" to both front and rear width. These required widths allow for centering of the unit. † Rear width is at corresponding depth. ‡ If an ash lip exists, the depth requirement begins inside of the lip (see Fig. 8-1 below).						

Table 1 - Product Specifications

Specification	Value	Qty.
02 burner system battery type	D battery	2
Remote transmitter battery type	12V battery	1
Remote receiver battery type	AA battery	4

Table 2 - Technical Data (if applicable)

Fireplace Requirements

These requirements MUST be met:

Ash Lip/Recess

DO NOT install this burner system in a fireplace with an ash lip or recess greater than $\frac{3}{4}$ ". See Fig. 8-1.

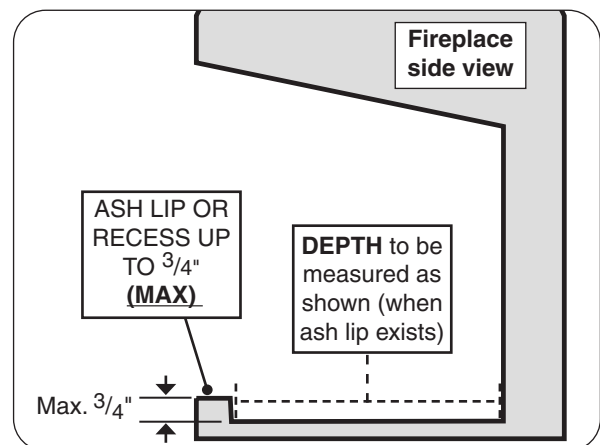

Fig. 8-1 Ash lip/recess detail

Fireplace Requirements (cont.)

Glass Doors

If this burner system is installed in a fireplace with glass doors, and the doors have a frame that OBSTRUCTS AIRFLOW to the fireplace floor, the frame MUST have slots (above the fireplace floor) that allow adequate ventilation. See Fig. 9-1.

Important: The opening (with doors fully open) MUST meet the minimum fireplace size front width and height requirements. See Table 1 (previous page) and Fig. 9-1.

Important: The glass doors MUST be fully open when the burner is in operation.

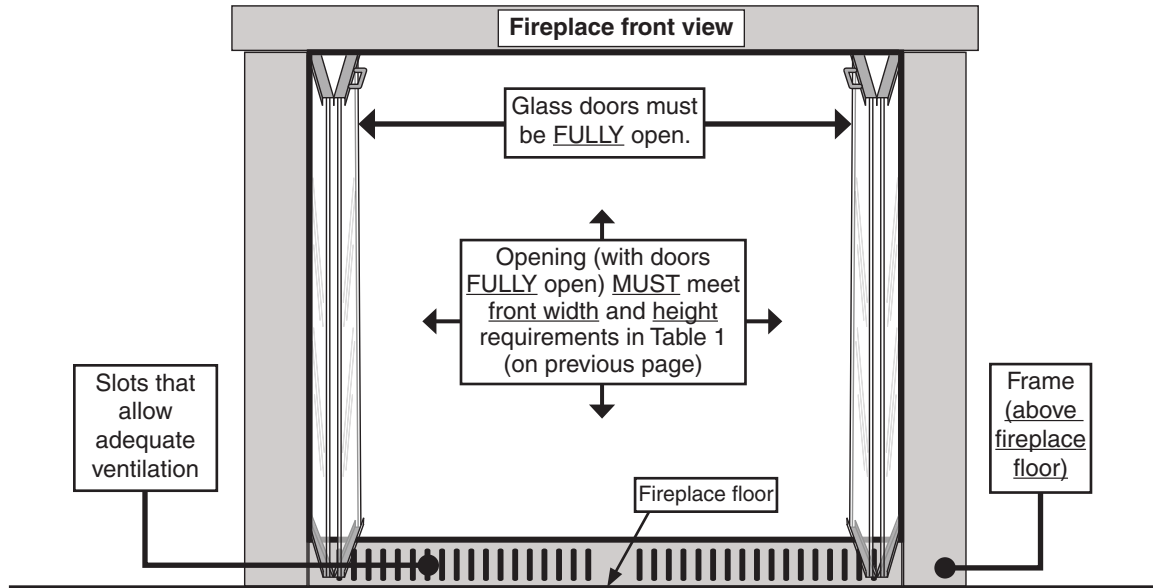

Fig. 9-1 Correct glass-doors frame setup, ventilation, and use (if applicable)

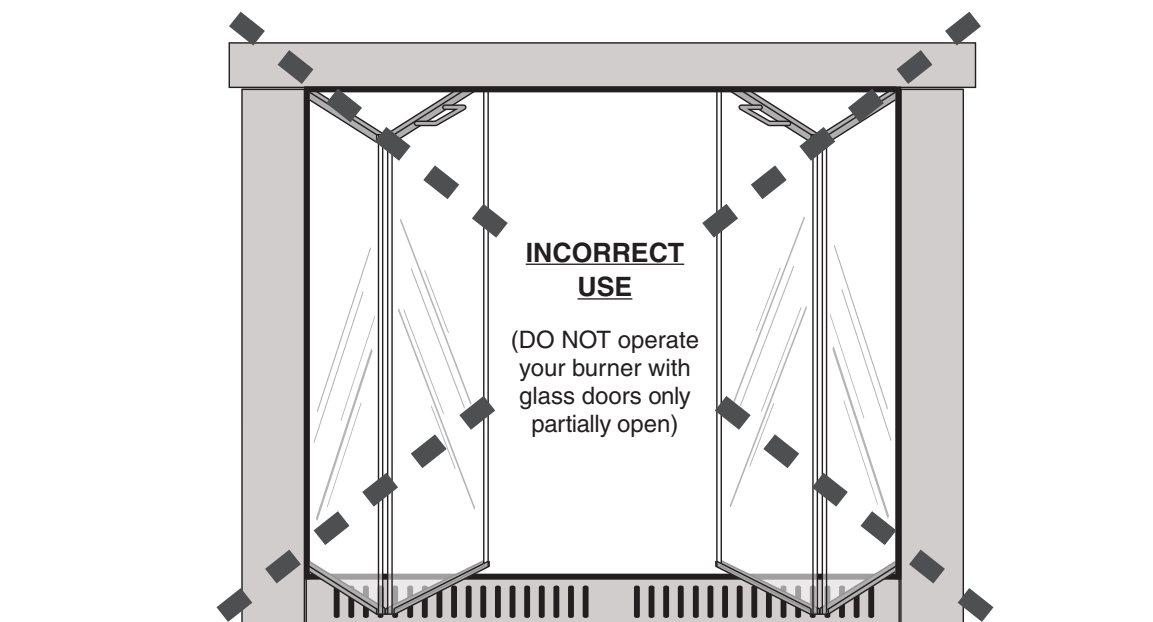

Fig. 9-3 Incorrect glass-doors frame setup, ventilation, and use (if applicable)

02 SERIES WIRING DIAGRAM

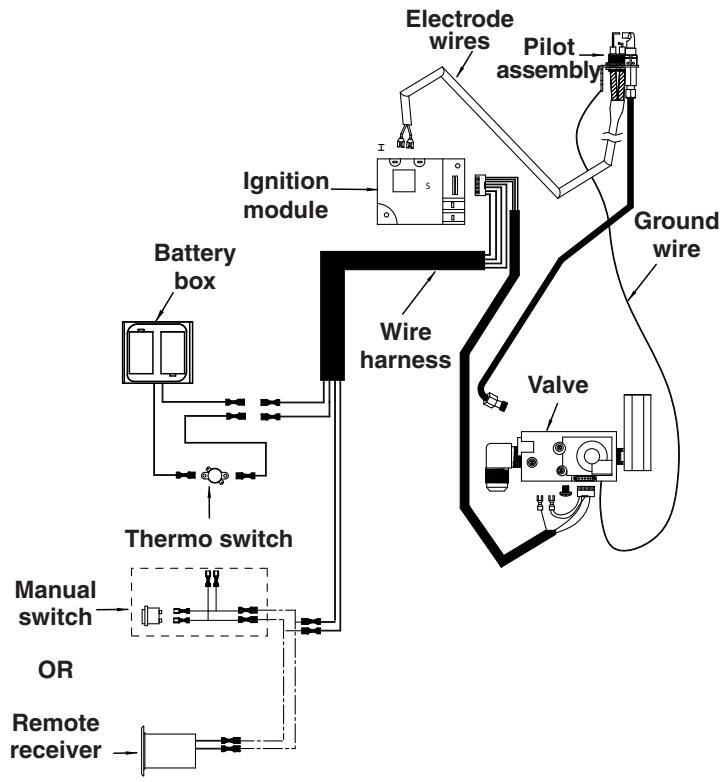

Fig. 10-1

17 SERIES WIRING DIAGRAM

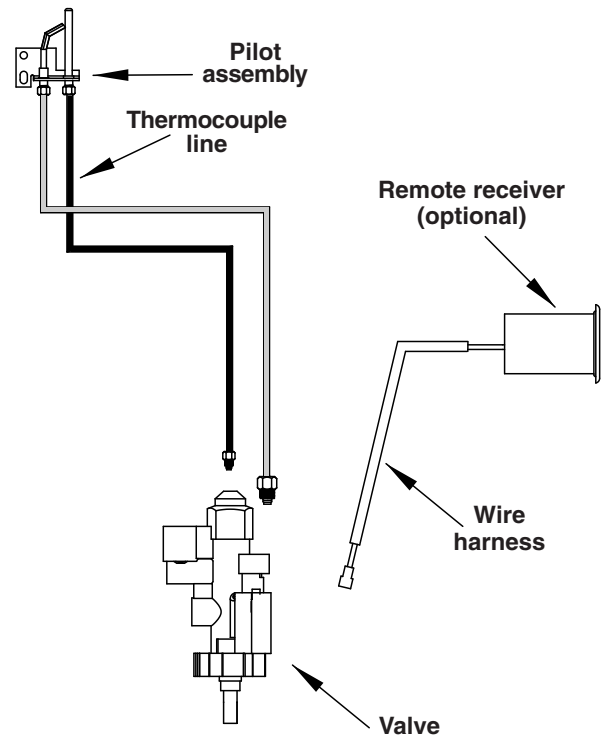

Fig. 10-2

DAMPER CLAMP INSTRUCTIONS

The damper clamp with hex bolt (Fig. 11-1) is provided as a means to prevent full closure of the damper blade. The clamp is easily attached to most damper blades with pliers or a wrench, and **must be permanently installed**. The clamp is designed to prevent accidental closure of the damper when installed as illustrated (Fig. 11-2). Should the clamp not fit, or fail to provide the permanent vent opening listed in Table 3 below, have a permanent stop installed, remove the damper blade, or have the damper cut to provide the minimum permanent opening required.

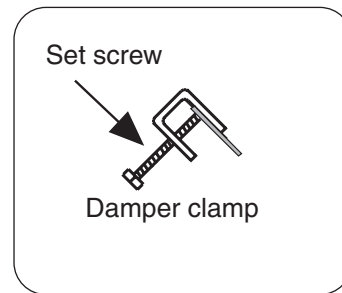

Fig. 11-1 Damper clamp detail

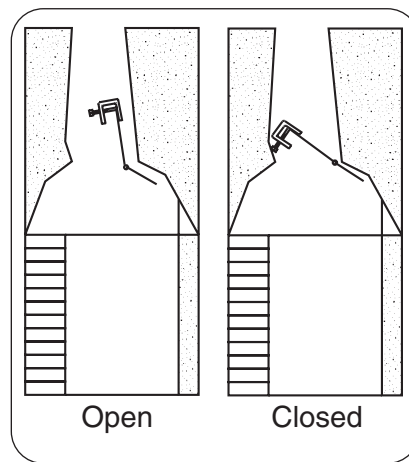

Fig. 11-2 Damper open / closed

Venting Requirements

Note: The minimum chimney height from hearth to top of chimney is 15'.

Minimum permanent free opening area of chimney damper for venting (sq. in.)		
	For factory-built fireplaces	
Chimney height	18/20"	24/30"
15'	36	47
20'	29	41
30'	23	31
	For masonry-built fireplaces	
15'	46	57
20'	43	52
30'	39	47

Table 3 - Minimum Chimney Damper Vent Opening Requirements

THESE ARE MINIMUM DAMPER OPENING SPECIFICATIONS.

THE DAMPER MUST BE COMPLETELY OPENED WHEN OPERATING THIS GAS APPLIANCE TO ACHIEVE THE BEST VENTILATION POSSIBLE.

GR47 BURNER PARTS LIST - MANUAL (A) SERIES

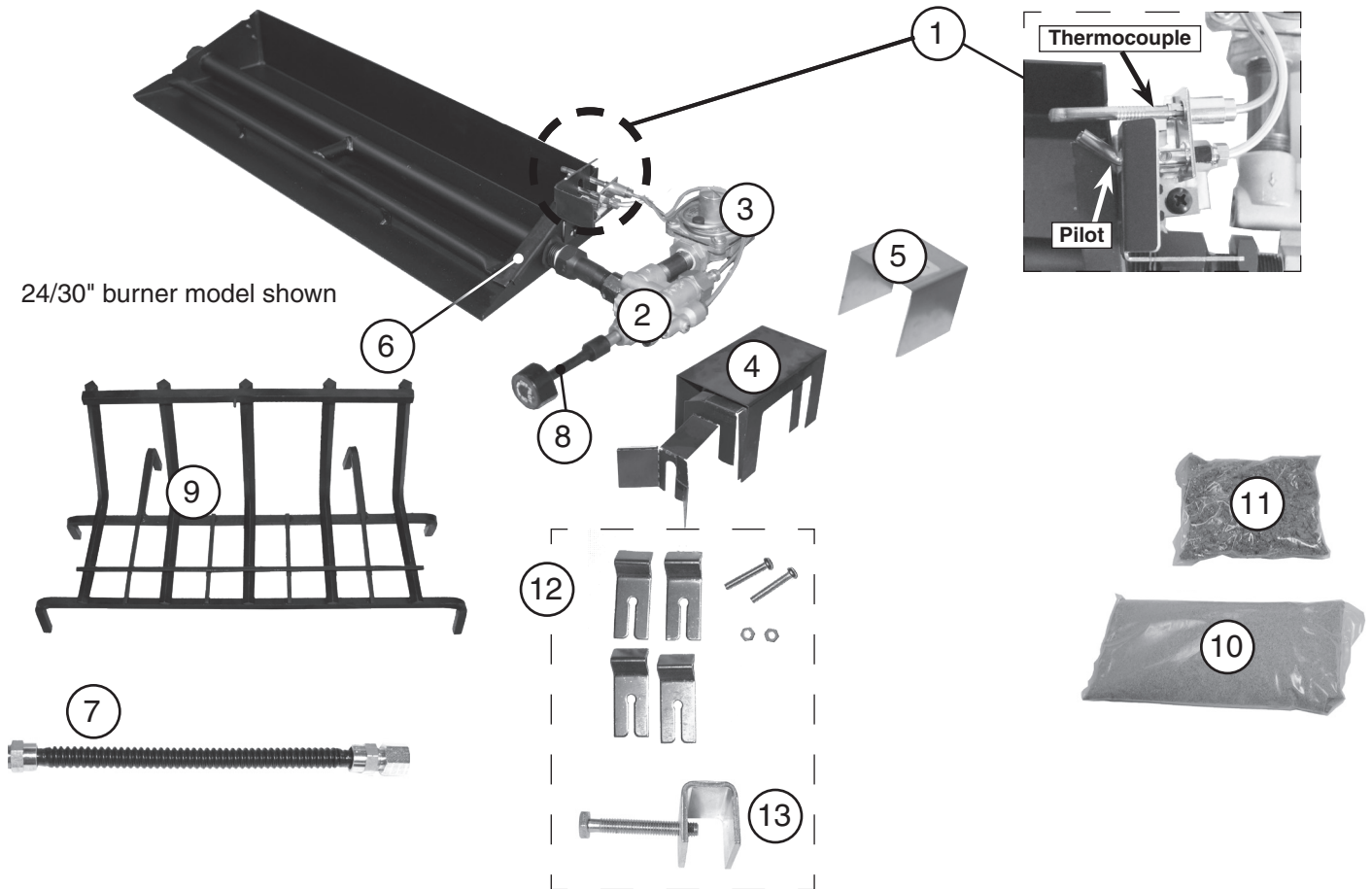

Note: Photos not to scale

Replacement parts can be ordered from your local Real Fyre dealer.

The log set is purchased and packaged separately; contact your local Real Fyre dealer when ordering. Refer to the instructions included with the log set.

Item	Description	18/20" model		24/30" model	
		Part No.	Qty.	Part No.	Qty.
1.	Pilot assembly (natural) or Pilot assembly (propane)	PAC-1NAT PAC-1LP	1 1	PAC-1NAT PAC-1LP	1 1
2.	Control valve (natural or propane)	SV-19	1	SV-19	1
3.	Pressure regulator (natural) or Pressure regulator (propane)	PR-3NAT PR-2LP	1 1	PR-3NAT PR-2LP	1 1
4.	Valve heat shield	HS-51	1	HS-51	1
5.	Regulator heat shield	HS-39	1	HS-39	1
6.	Flame diverter bracket	SH-1	1	SH-1	1
7.	Flex connector (w/ adapter), 1/2" O.D. x 12"	CK-5-SP	1	CK-5-SP	1
8.	Control knob w/ extension	EH-11H	1	EH-11H	1
9.	Grate	SD-RUM-18/20	1	SD-RUM-24/30	1
10.	Sand (natural gas) or Vermiculite (propane gas)	CS-8 LF-15-3.5	1 1	CS-10 LF-15-7	1 1
11.	Black embers	EB-1	1	EB-1	1
12.	Hardware kit (damper clamp, stabilizer clips w/ screws and nuts)	HK-1	1	HK-1	1
13.	Damper clamp (only)	DC-1	1	DC-1	1

GR47 BURNER PARTS LIST - 02 SERIES

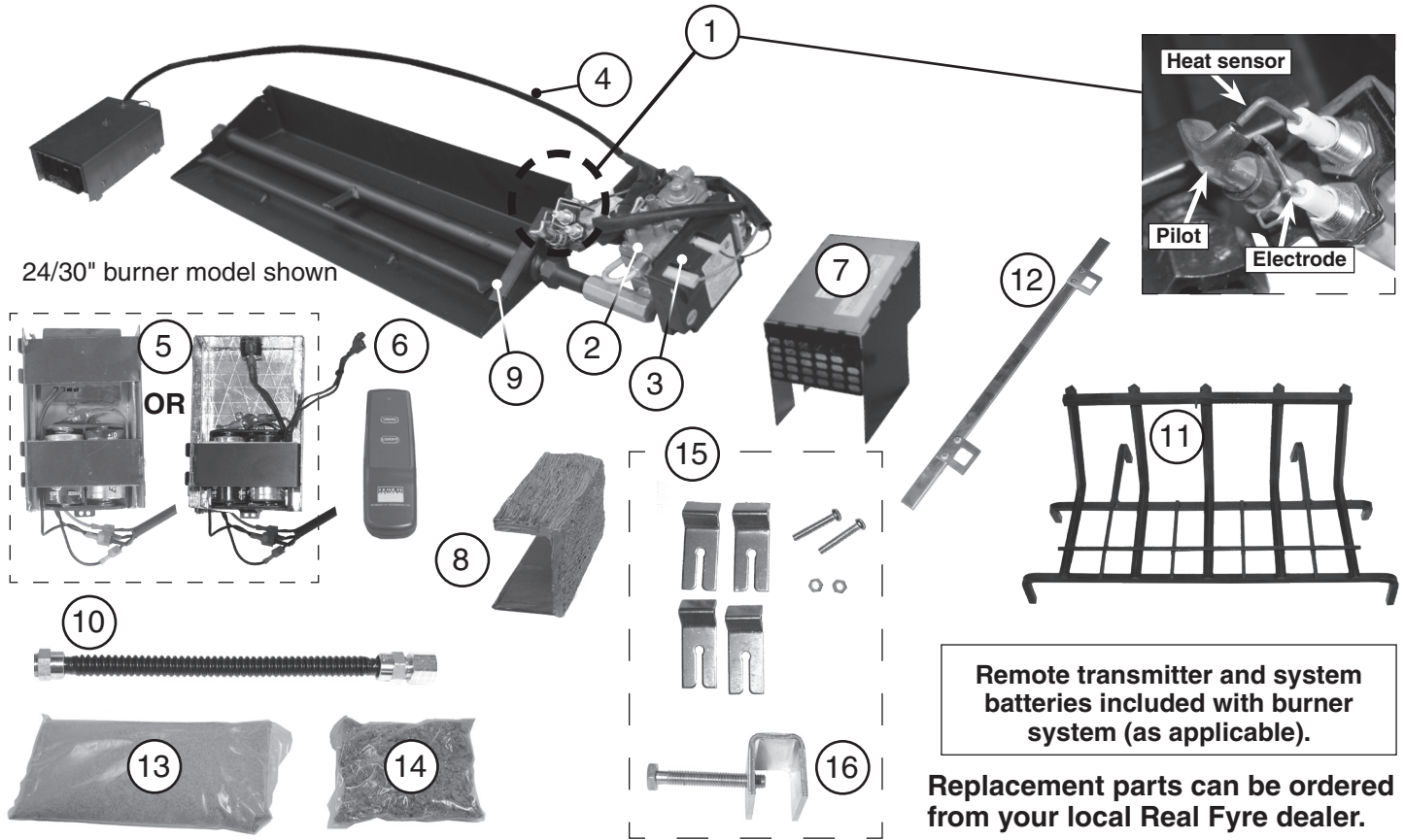

24/30" burner model shown

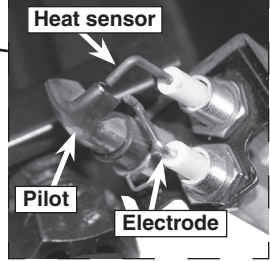

Remote transmitter and system batteries included with burner system (as applicable).

Replacement parts can be ordered from your local Real Fyre dealer.

Note: Photos not to scale

The log set is purchased and packaged separately; contact your local Real Fyre dealer when ordering. Refer to the instructions included with the log set.

Important: Minimum fireplace size for **02 series** is larger than other GR47 models (by 2" front & rear width).

Item	Description	18/20" model		24/30" model	
		Part No.	Qty.	Part No.	Qty.
1.	Pilot assembly (natural) or Pilot assembly (propane)	PAC-6 PAC-7	1 1	PAC-6 PAC-7	1 1
2.	Control valve (natural) or Control valve (propane)	SV-45 SV-45P	1 1	SV-45 SV-45P	1 1
3.	Control module	IMP-1	1	IMP-1	1
4.	Main harness assembly	WH-11	1	WH-11	1
5.	Remote receiver box (includes remote receiver, battery box, thermo switch, metal heat shield) Switch box assembly * or (includes battery box, ON/OFF switch, thermo switch, metal heat shield)	AR-02-1 EPK-64	1 1	AR-02-1 EPK-64	1 1
6.	Remote transmitter (only - if equipped)	AT-R1-1	1	AT-R1-1	1
7.	Valve heat shield	HS-38	1	HS-38	1
8.	Decorative heat shield	HS-52	1	HS-52	1
9.	Flame diverter bracket	SH-1	1	SH-1	1
10.	Flex connector (w/ adapter), 1/2" O.D. x 12"	CK-5-SP	1	CK-5-SP	1
11.	Grate	SD-RUM-18/20	1	SD-RUM-24/30	1
12.	Wire guard	WHG-1	1	WHG-2	1
13.	Sand (natural gas) or Vermiculite (propane gas)	CS-8 LF-15-3.5	1 1	CS-10 LF-15-7	1 1
14.	Black embers	EB-1	1	EB-1	1
15.	Hardware kit (damper clamp, stabilizer clips w/ screws and nuts)	HK-1	1	HK-1	1
16.	Damper clamp (only)	DC-1	1	DC-1	1

* to add a remote system to an 02M model, use RR-1A

GR47 BURNER PARTS LIST - 17 SERIES

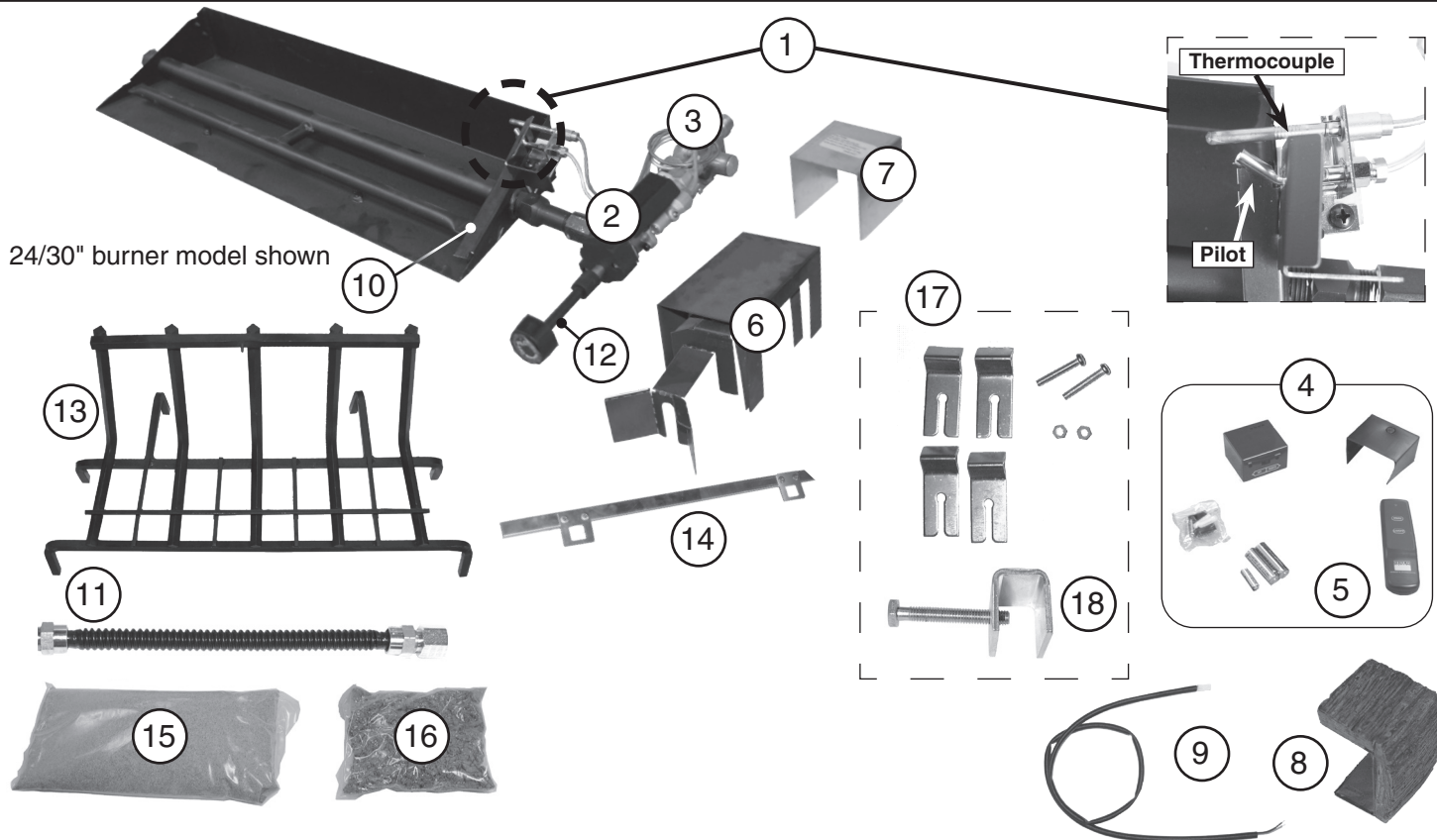

Note: Photos not to scale
Replacement parts can be ordered from your local Real Fyre dealer.

The log set is purchased and packaged separately; contact your local Real Fyre dealer when ordering. Refer to the instructions included with the log set.

Item	Description	18/20" model		24/30" model	
		Part No.	Qty.	Part No.	Qty.
1.	Pilot assembly (natural) or Pilot assembly (propane)	PAC-1NAT PAC-1LP	1 1	PAC-1NAT PAC-1LP	1 1
2.	Control valve (natural or propane)	SV-37	1	SV-37	1
3.	Pressure regulator (natural) Pressure regulator (propane)	PR-3NAT PR-2LP	1 1	PR-3NAT PR-2LP	1 1
4.	Remote kit * † (includes receiver, transmitter, batteries, plastic cover)	VR-1A	1	VR-1A	1
5.	Remote transmitter (only) *	AT-V1-1	1	AT-V1-1	1
6.	Valve heat shield	HS-51	1	HS-51	1
7.	Regulator heat shield	HS-39	1	HS-39	1
8.	Decorative heat shield * †	HS-53	1	HS-53	1
9.	Remote receiver wire harness * †	WH-01	1	WH-01	1
10.	Flame diverter bracket	SH-1	1	SH-1	1
11.	Flex connector (w/ adapter), 1/2" O.D. x 12"	CK-5-SP	1	CK-5-SP	1
12.	Control knob w/ extension	EH-11H	1	EH-11H	1
13.	Grate	SD-RUM-18/20	1	SD-RUM-24/30	1
14.	Wire guard	WHG-1	1	WHG-2	1
15.	Sand (natural gas) or Vermiculite (propane gas)	CS-8 LF-15-3.5	1 1	CS-10 LF-15-7	1 1
16.	Black embers	EB-1	1	EB-1	1
17.	Hardware kit (damper clamp, stabilizer clips w/ screws and nuts)	HK-1	1	HK-1	1
18.	Damper clamp (only)	DC-1	1	DC-1	1

* if equipped

† to add a remote system to a 17M model, use VR-1A, HS-53, and WH-01

INSTALLATION

The Real Fyre burner system must be installed by a qualified professional service technician. Instructions must be followed carefully to ensure proper performance and full benefit from the burner system. **Check to be sure the burner system is designed and labeled for the type of gas (natural or propane gas) supplied to fireplace.** Fireplace floor must be level, clean, and smooth (see FIREPLACE SAFETY INFORMATION section).

WARNING: Failure to position the parts in accordance with these diagrams or failure to use only parts specifically approved with this appliance may result in property damage or personal injury.

REFER TO THE PARTS LIST WHEN FOLLOWING INSTALLATION INSTRUCTIONS. 24/30" burner model shown here.

INSTALL BURNER

1. MAKE SURE FIREPLACE GAS SUPPLY IS TURNED OFF.
2. Locate the gas-supply stub inside the fireplace and remove the cap, if attached (reference Fig. 15-1).

CAUTION: When removing the cap, make sure the stub does not turn, loosening the connection inside the wall.

3. Attach the nut end of the flex connector to the adapter found on the valve or, if attached, on the regulator behind the valve. Tighten securely.
4. Place the burner system in the fireplace. Center the burner from left to right in the fireplace. See Fig. 15-2.
5. **Be sure gas to the fireplace is off.** Remove the adapter connected to the flex connector. Attach the adapter to the gas-supply stub using a pipe compound resistant to all gasses. Tighten securely. Then attach the open end of the flex connector to the adapter. Tighten securely (see Fig. 15-1). Ensure the pan rests level on the fireplace floor after connection. Adjust the pan if necessary.
6. **LEAK TEST:** Make sure the burner valve is in the OFF position. Turn on the fireplace gas supply, and test at all connections for leaks using the appropriate soapy water solution. See Fig. 15-3. If bubbles appear, a leak is present. Turn off the gas and tighten at all connections. Repeat until no leaks are present. If a leak persists, turn off the gas supply and contact the local gas company or dealer. NEVER USE A FLAME TO CHECK FOR LEAKS.

For manual and 17M models, continue to PREPARE GRATE section.

INSTALL BATTERIES (if applicable)

At this stage the burner system and remote batteries are to be installed. Reference the INSTALLING/REPLACING BATTERIES section for details.

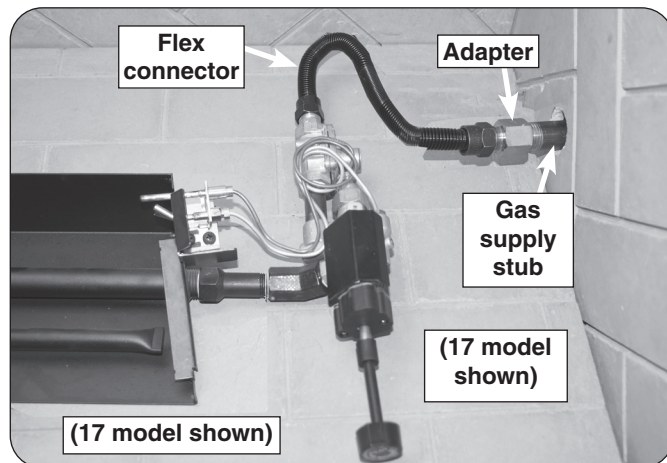

Fig. 15-1 Connect gas supply



Fig. 15-2 Center burner pan in fireplace

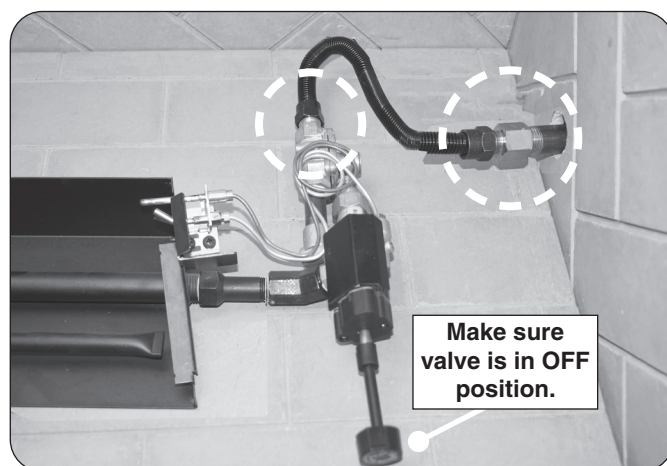

Fig. 15-3 Perform leak test

Installation continued on next page

INSTALL REMOTE RECEIVER / SWITCH BOX (if applicable - 02 & 17 models)

For 02 models proceed to step 2

- 1. 17 Models Only:** If this unit was shipped with a remote, read and follow the separate remote instructions (packed with remote) for connecting the remote to the valve. Then continue to step 2.
- Place the receiver/switch box inside the firebox. Position so that it is:
 - located at the left front of the firebox.
 - on its side, with its bottom toward the left firebox wall.
 - a minimum of 4" from the burner/flame.

See Fig. 16-1, A or B for details.

DO NOT place the receiver/switch box at the rear of the firebox. Ensure that the box wire harness remains away from the burner, valve, heat shield, and flame at all times. Coil any excess wire within the box.

CAUTION: THE BOX WILL BE HOT DURING AND AFTER OPERATION.

3. Decorative Heat Shield

Note: The decorative heatshield has a rear wall with a notch in it. Face this notched end toward the back of the fireplace, and route the wire harness through the notch.

17 Models: Ensure the remote receiver is properly installed (with the plastic cover over it). Then place the decorative heat shield over the remote receiver. See Fig. 16-1, A.

02 Models: Place the decorative heat shield over the remote receiver / switch box (see Fig. 16-1, B).

CAUTION: THE REMOTE RECEIVER / SWITCH BOX AND DECORATIVE HEAT SHIELD WILL BE HOT DURING AND AFTER OPERATION.

PLACE WIRE GUARD (if applicable)

- 02, 02M, & 17 models only:** Place the wire guard over the wire harness that is routed along the rear of the fireplace. (The wire routes from the valve assembly to the remote receiver / switch box.) See Fig. 16-2 and 16-3.

Note: Manual models and 17M models without a remote system do not require this step. Proceed to the next section.

Installation continued on next page

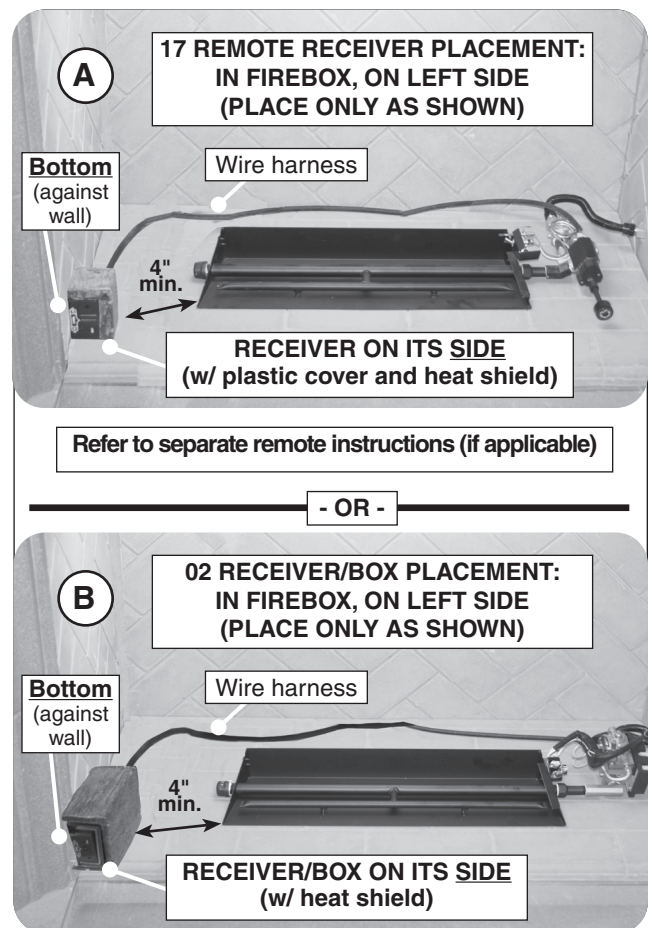

Fig. 16-1 Install remote receiver / switch box and heat shield (if applicable)

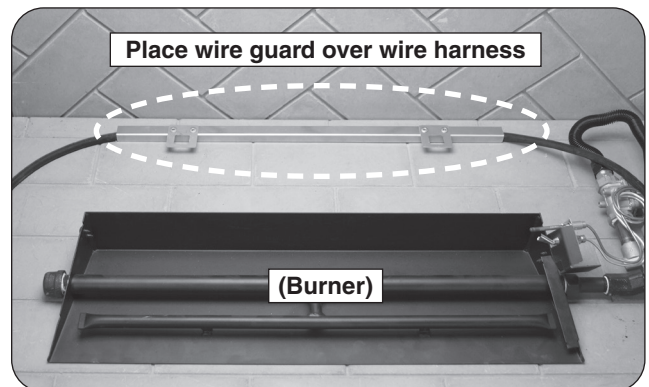

Fig. 16-2 Place wire guard (if applicable)

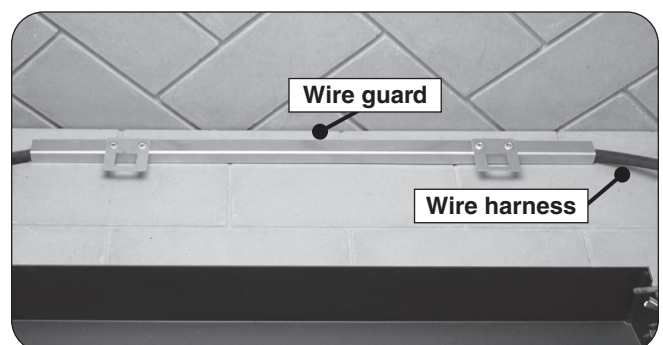

Fig. 16-3 Wire guard placement detail

PREPARE GRATE AND CENTER

1. Locate the grate (outside of the fireplace), and attach the stabilizer clips to the 2 inner bars of the grate using the provided screws and nuts (see Fig. 17-1 and Fig. 17-3).

The stabilizer clips should be positioned on the inner bars and oriented as shown. **Note the 1 1/2" spacing in Fig. 17-3.** Tighten the clips in place.

2. Position the grate over the burner pan (in the fireplace) so that:
 - the stabilizer clips fit over the back edge of the pan to lock it in position.
 - the rear grate legs insert into the wire guard cutouts (if applicable).
 - the assembly is centered from left to right.

See Fig. 17-2 and Fig. 17-3.

Then remove the grate for future media placement.

Installation continued on next page

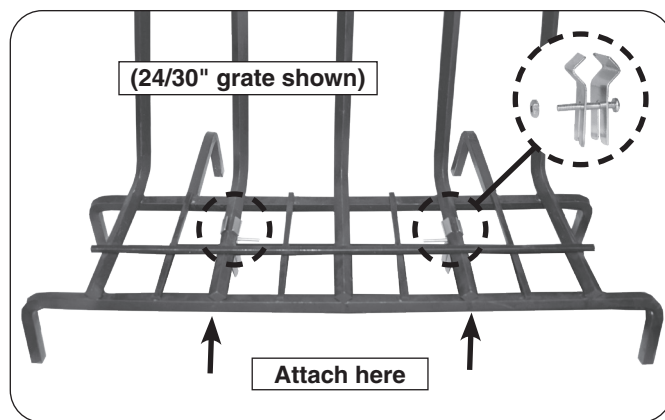

Fig. 17-1 Attach stabilizer clips to grate

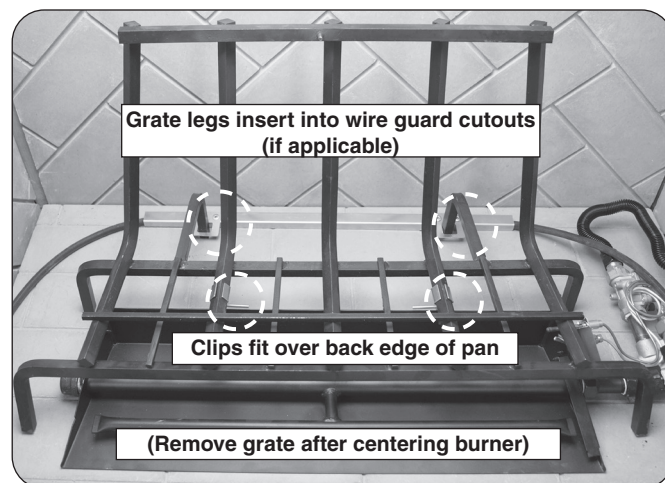

Fig. 17-2 Position grate

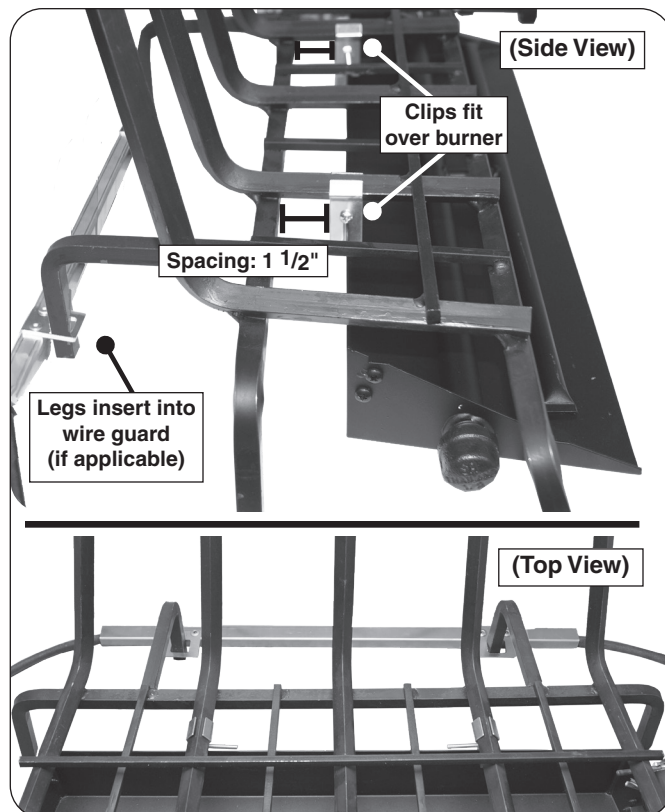

Fig. 17-3 Grate placement detail

HEAT SHIELD PLACEMENT

TO PREVENT DAMAGE AND FAILURE:

IT IS CRITICAL THAT THE HEAT SHIELD(S) BE PLACED CORRECTLY OVER THE REGULATOR AND/OR VALVE PRIOR TO OPERATION.

TO PREVENT OVERHEATING:

Place the valve heat shield over the valve as shown in the applicable image of Fig. 18-1. It should rest flat above the valve.

For manual and 17 models, place the regulator heat shield as shown in the applicable image of Fig. 18-1. It should rest flat above the regulator.

Keep the area above and below the heat shield(s) clear of decorative media or any other objects at all times.

DO NOT remove the heat shield(s).

Important: Ensure any lines/tubes/wires from the valve do not interfere with heat shield placement.

LIGHTING TEST

Prior to proceeding with installation, perform a lighting test (see lighting instructions for lighting your burner). **Allow the unit to completely cool after testing.**

IMPORTANT

For all valves, the air **MUST** be purged from the gas line before the pilot will light and burn properly. The time needed to purge will depend on the length of the gas line to the unit and the amount of time since the unit or gas line was last used. It may take several minutes before all the air is purged and the pilot will light and burn properly. Reference the LIGHTING INSTRUCTIONS section in this manual.

LAVA GRANULES/COALS (optional)

Optional lava granules and lava coals are available for decorative purposes. Contact your dealer for ordering information.

If purchased, follow the steps below.

1. Spread the lava granules on the floor of the fireplace, around the front and sides of the burner system (see Fig. 18-2).
2. Repeat this process for the lava coals (on top of the already placed lava granules).

Note: DO NOT place any lava media on the burner system, behind it, on or within the heat shield, or under a knob if one exists at the front of the valve (see Fig. 18-3).

For models with a receiver/switch box, the lava media may be placed around the box. Leave the front of the receiver/switch box clear for control access.

Installation continued on next page

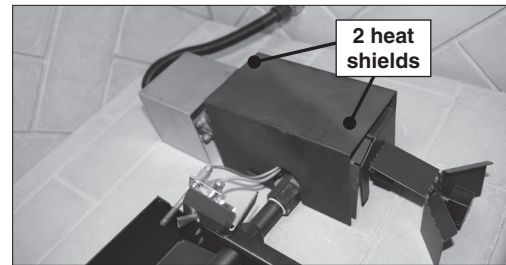

Manual and 17 Models



02 Model

Heat shield(s) MUST:

- be placed over regulator and/or valve (DO NOT remove)
- rest flat
- be kept clear of all media and objects

Fig. 18-1 Place heat shield(s)

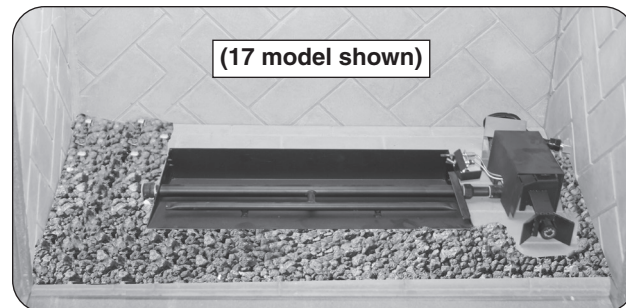

Fig. 18-2 Place lava media (if purchased)

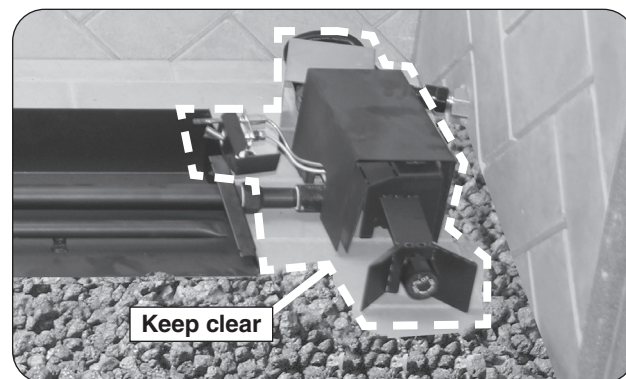

Fig. 18-3 Proper lava media placement

SAND/VERMICULITE PLACEMENT

The sand/vermiculite supplied with the unit is specially selected for use with either natural or propane gas. It maximizes flame distribution and provides a cleaner burning flame.

CAUTION: Use only sand for natural gas burners and vermiculite for propane gas burners.

1. Fill the burner pan completely with the sand/vermiculite (see Fig. 19-1). **Avoid spilling the sand/vermiculite on the pilot assembly. DO NOT place sand/vermiculite on any other parts of the burner, valve, or heat shield.**
2. **Slope the sand/vermiculite at the same angle as the burner pan.** This is important to ensure quiet lighting and even flame distribution. See Fig. 19-2.

BLACK EMBERS PLACEMENT

Spread the black embers lightly and evenly over the entire surface of the sand/vermiculite as shown in Fig. 19-3. **Break up any clumps that may have developed during shipment. Completely cover the sand/vermiculite. DO NOT pack the embers down.**

KEEP LAVA GRANULES/COALS, SAND/VERMICULITE, EMBERS, AND ALL FOREIGN OBJECTS AWAY FROM THE PILOT ASSEMBLY, VALVE ASSEMBLY, AND HEAT SHIELD(S) DURING MEDIA PLACEMENT AND AT ALLTIMES. SEE FIG. 19-4.

Installation continued on next page

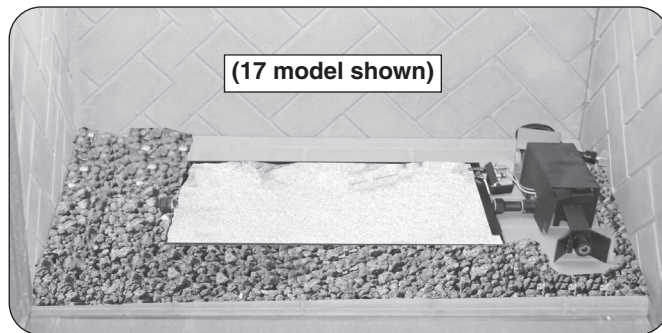

Fig. 19-1 Place sand/vermiculite

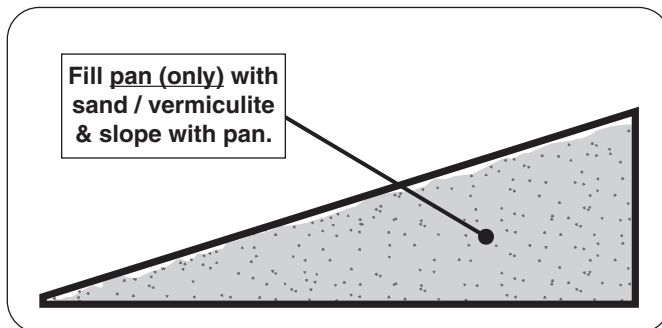

Fig. 19-2 Sand/vermiculite detail

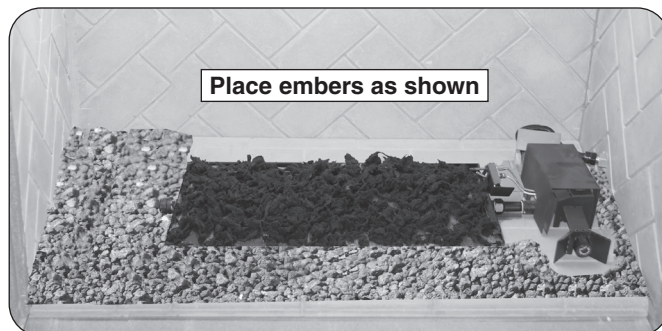

Fig. 19-3 Place black embers

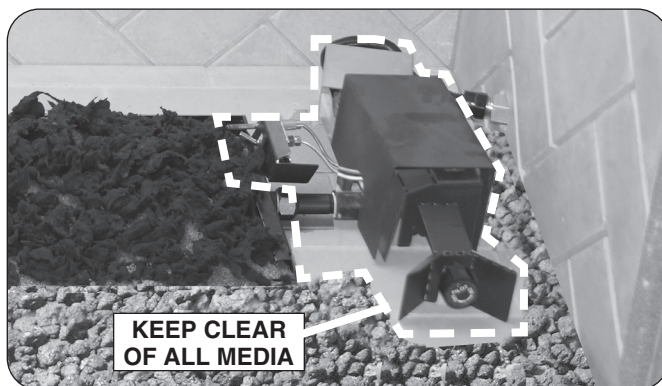

Fig. 19-4 Keep pilot, valve, & shield(s) clear

GRATE PLACEMENT

1. Place the grate over the burner pan so that:
 - the stabilizer clips fit over the back edge of the pan to lock it in position.
 - the rear grate legs insert into the wire guard cutouts (if applicable).

See Fig. 20-1.

2. Place a second layer of embers lightly and evenly over the burner and grate area. Be sure to cover the grate bars/fingers as shown. See Fig. 20-1.

Break up any clumps that may have developed during shipment. Completely cover the area as shown. DO NOT pack the embers down.

Store unused embers for later use/replacement.

Installation continued on next page

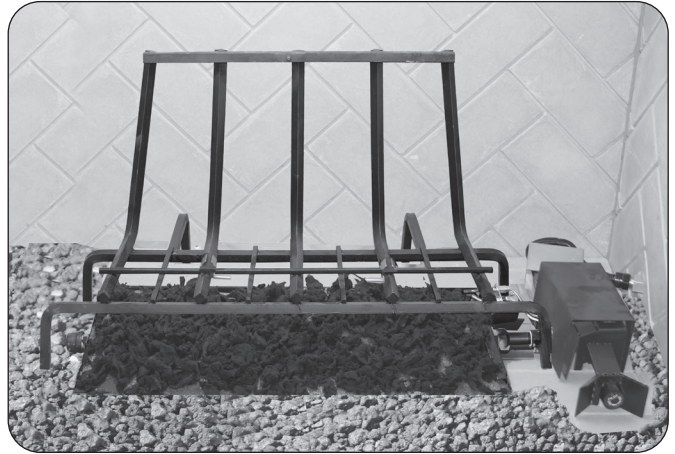

Fig. 20-1 Place grate

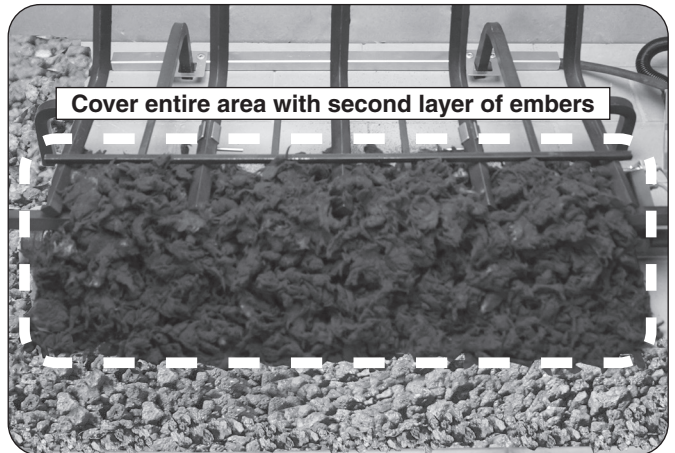
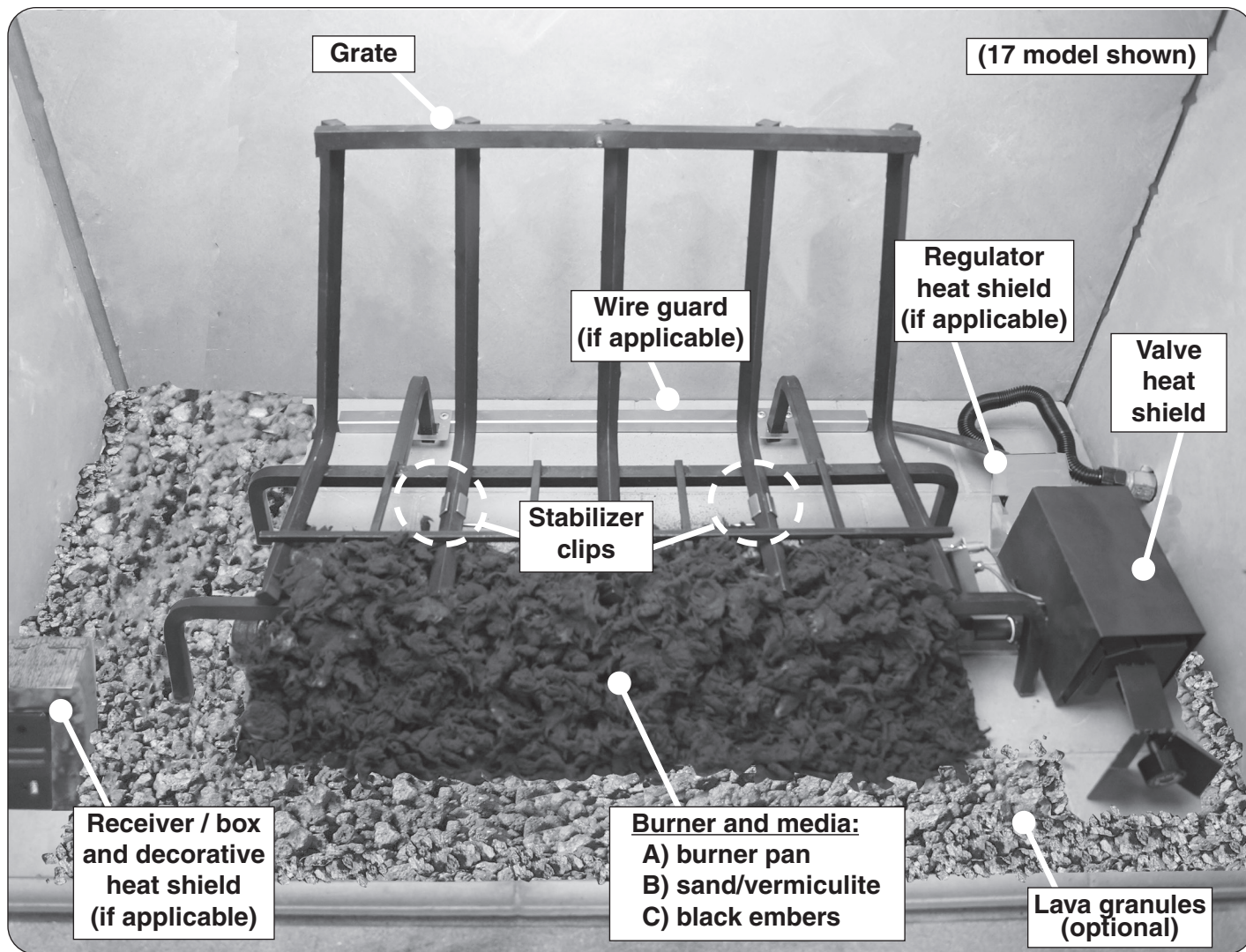

Fig. 20-2 Place additional black embers

INSTALLATION (cont.)

At this stage the burner, media, and grate installation should look as depicted below.



LOG SET PLACEMENT

- Follow the instructions included with the log set for step by step log placement.
- Read all safety warnings and important information in the instructions supplied with the log set to ensure proper placement.
- **DO NOT** add any additional embers to this log set. Any additional embers will cause unsafe operation.

Below are examples of available log sets for this burner system:



Rural Oak (RUO-24/30)



Aged Rural Oak (RUA-24/30)



Rural Oak Split (RUSO-24/30)

Important: **Adequate ventilation is absolutely necessary!** Provided noticeable sooting does not occur, some flexibility is possible in log placement to suit your individual preference. If you experience any accumulation of black carbon (soot) on your logs, it is an indication of incomplete combustion and you must move the affected log(s) so as to minimize the flame contact on the affected log(s). Read the instructions supplied with the log set completely and carefully.

CAUTION: **BURN HAZARD!** Logs will remain hot for some time after use. If you need to reposition any log to maintain the proper layout, use heat-resistant gloves or allow logs adequate time to cool before handling.

INSTALLING/REPLACING BATTERIES (IF APPLICABLE)

CAUTION: Ensure the unit is connected to the gas line and has been tested for leaks before you insert batteries.

CAUTION: Turn off the remote and/or burner and allow the unit to completely cool prior to any battery replacements.

Important: Prior to inserting batteries, always apply a small amount of dielectric grease to both ends of each battery. This will ensure conductivity and prevent moisture from affecting the contact.

Important: **Low/dead batteries will affect burner system operation. Replace batteries any time the burner will not turn on.**

REMOTE TRANSMITTER BATTERY

The remote transmitter requires one 12V battery to operate (included). Locate the transmitter, remove the lid (found on rear), and properly insert the new battery as marked. Re-secure the lid. See Fig. 23-1.

RECEIVER/BURNER SYSTEM BATTERIES

Important: Be sure to replace the decorative heat shield over the receiver or switch box assembly after battery replacement.

Remote receiver

02 models

The remote receiver requires 4 AA batteries to operate (included). Locate the remote receiver box and turn it over. Use a Phillips screwdriver to remove the screw found on the side of the box, then remove the bracket. Remove the receiver from the box and turn it over. Slide open the lid, and properly insert the new batteries as marked. See Fig. 23-2 (also reference Fig. 23-3).

Replace the lid and replace the remote receiver onto the Velcro in the remote receiver box. Then replace the bracket using the screw and re-position the box in the fireplace.

17 models

The remote receiver requires 4 AA batteries to operate (included). Locate the remote receiver and turn it over. Slide open the lid, and properly insert the new batteries as marked. See Fig. 23-2.

Replace the lid, then re-position the remote receiver in the fireplace. (Ensure the plastic cover is properly in place over the receiver.)

Burner system (02 models)

The burner system requires 2 D batteries to operate (included). Locate the remote receiver / switch box and turn it over. Use a Phillips screwdriver to remove the screw found on the side of the box, then remove the bracket. Properly insert the new batteries as marked. See Fig. 23-3.

Replace the bracket using the screw and re-position the remote receiver / switch box in the fireplace.



Fig. 23-1 Transmitter battery

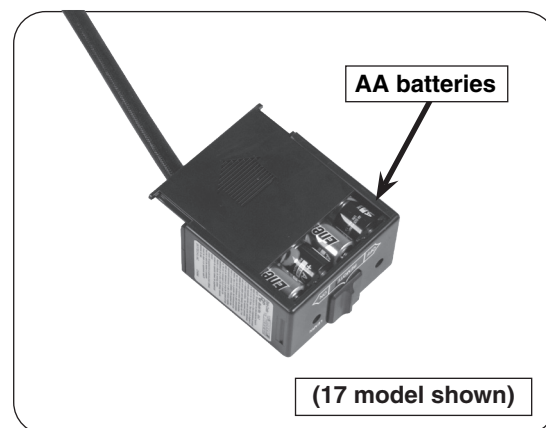

Fig. 23-2 Remote receiver batteries

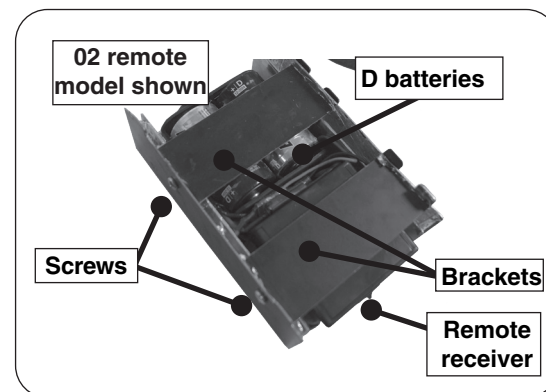

Fig. 23-3 Receiver/switch box batteries

Please use this page to record any information that you may want to have at hand.

LIGHTING INSTRUCTIONS - MANUAL (A) SERIES

FOR YOUR SAFETY, READ BEFORE LIGHTING

WARNING: If you do not follow these instructions exactly, a fire or explosion may result causing property damage, personal injury or loss of life.

- A.** Use only your hand to push in or turn the gas control knob. Never use tools. If the knob will not push in or turn by hand, don't try to repair it. Call a qualified professional service technician. Excessive force or attempted repair may result in fire or explosion.
- B. BEFORE OPERATING**, smell all around the appliance area for gas. Be sure to smell next to the floor because some gas is heavier than air and will settle on the floor.

WHAT TO DO IF YOU SMELL GAS

- Do not light any appliance.
 - Do not touch any electric switch; do not use any phone in your building.
 - Immediately call your gas supplier from a neighbor's phone. Follow the gas supplier's instructions. If you cannot reach your gas supplier, call the fire department.
- C.** The burner system has a pilot that can be lit by hand using a long fireplace match or lighter. When lighting the pilot, follow these instructions exactly.
- D.** Do not use this appliance if any part has been underwater. Immediately call a qualified service technician to inspect the appliance and to replace any part of the control system and any gas control which has been underwater. Attempted operation may result in fire or explosion resulting in property damage, personal injury or loss of life.

LIGHTING THE PILOT

1. Locate the valve on the side of the unit. Push in the gas control knob slightly and turn clockwise to **OFF** (Fig. 25-1).

Note: The control knob cannot be turned from **PILOT** to **OFF** unless the knob is pushed in slightly. Do not force.

Allow five (5) minutes for any gas in the unit to dissipate. IF YOU SMELL GAS, SEE STEP B ABOVE. If you don't smell gas, go on to step 2.

2. Turn the control knob counterclockwise to **PILOT** (Fig. 25-1). Push the control knob **firmly and fully** in and hold. Hold a long fireplace match or lighter near the thermocouple to light the pilot. Continue to hold the control knob in for approximately 60 seconds after the pilot is lit, then release the knob. The pilot will remain lit.

WARNING: If the pilot fails to light repeat steps 1 and 2.

If the pilot fails to light after several tries, turn the control knob to **OFF** and contact a qualified professional service technician.

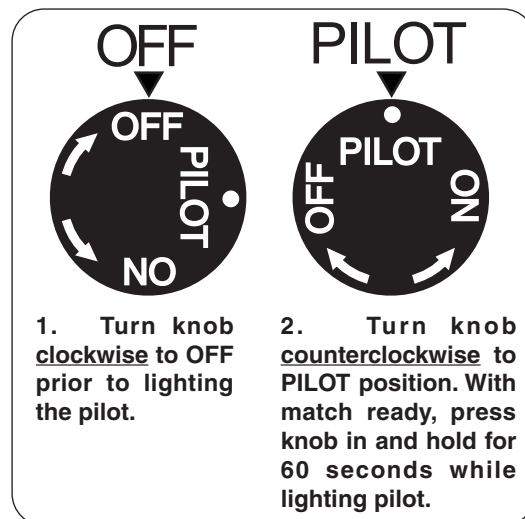

Fig. 25-1 Control knob detail (OFF, PILOT)

INSTRUCTIONS D'ALLUMAGE - SÉRIE MANUEL (A)

POUR VOTRE SÉCURITÉ, LISEZ AVANT D'ALLUMER

AVERTISSEMENT: Si vous ne suivez pas ces instructions à la lettre, un incendie ou une explosion entraînant des dommages matériels, des blessures ou des pertes de vie.

- A.** N'utilisez que votre main pour enfoncer ou tourner le bouton de contrôle du gaz. Ne jamais utiliser d'outils. Si le bouton ne sera pas enfoncer ou à tourner à la main, n'essayez pas de le réparer. Appelez un technicien de service qualifié. Une force excessive ou une tentative de réparation pourrait provoquer un incendie ou une explosion.
- B. AVANT DE FAIRE FONCTIONNER,** sentez autour de l'appareil pour le gaz. Assurez-vous de sentir près du plancher, car certains gaz sont plus lourds que l'air et se déposent sur le sol.

QUE FAIRE SI UNE ODEUR DE GAZ

- Ne pas allumer l'appareil.
 - Ne touchez à aucun interrupteur électrique; n'utilisez aucun téléphone dans votre bâtiment.
 - Appelez immédiatement votre fournisseur de gaz à partir du téléphone d'un voisin. Suivez les instructions du fournisseur de gaz. Si vous ne pouvez joindre votre fournisseur de gaz, appeler les pompiers.
- C.** Le système de brûleur a un pilote qui peut être allumée à la main à l'aide d'une allumette ou long cou léger. Pour allumer la veilleuse, suivez ces instructions à la lettre.
- D.** Ne pas utiliser cet appareil si une partie quelconque a été submergée. Appelez immédiatement un technicien de service qualifié pour inspecter l'appareil et pour remplacer toute pièce du système de contrôle et toute commande de gaz qui a été sous l'eau. Tentative d'opération peut entraîner un incendie ou une explosion entraînant des dommages matériels, des blessures ou des pertes de vie.

ALLUMAGE DU PILOTE

1. Localiser la vanne sur le côté de l'appareil. Appuyer sur le bouton légèrement de contrôle du gaz et tourner dans le sens horaire à **OFF** (Fig. 26-1).

Note: Le bouton de commande ne peut être activée à partir **PILOTE** sur **OFF** si le bouton est enfoncé légèrement. Ne pas forcer.

Attendez cinq (5) minutes pour n'importe quel gaz dans l'unité de se dissiper. S'IL YA UNE ODEUR DE GAZ, voir l'étape B CI-DESSUS. Si vous ne sentez pas de gaz, passez à l'étape 2.

2. Tournez le bouton de réglage dans le sens antihoraire pour **PILOTE** (Fig. 26-1). Appuyez sur le bouton de commande **fermement et pleinement** enfoncée. Mantenga partido largo chimenea o un encendedor cerca del termopar a encender el piloto. Continúe a tenir le bouton de commande pendant environ 60 secondes après que le pilote est allumé, puis relâchez le bouton. Le pilote reste allumé.

AVERTISSEMENT: Si le pilote ne s'allume pas, répétez les étapes 1 et 2.

Si la télécommande ne fonctionne pas, et des batteries avec un niveau de puissance adéquate sont installés, reportez-vous à la synchronisation des section REMOTE.

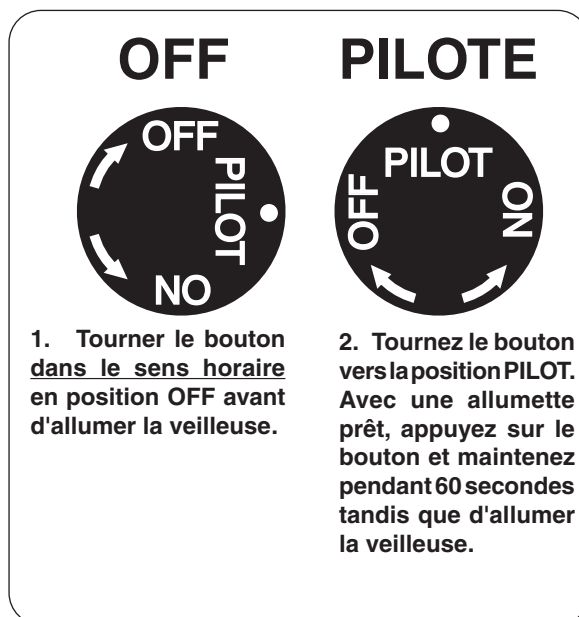

Fig. 26-1 Détail bouton de commande (OFF, PILOTE)

LIGHTING THE BURNER

1. Ensure the pilot is burning. Turn the gas control knob counterclockwise to **ON** (Fig. 27-1) to ignite the burner. The valve will open and the burner will light.

Note: The ignition sequence will take approximately 5 seconds.

WARNING: If the burner fails to light within 5 seconds, turn the control knob clockwise to **PILOT**. Allow five (5) minutes for any gas in the unit to dissipate, then repeat step 1 above. **IF YOU SMELL GAS, SEE STEP B AT BEGINNING OF LIGHTING INSTRUCTIONS.**

If the burner fails to light after several tries, push in the control knob slightly and turn clockwise to **OFF**, and contact a qualified professional service technician.

SHUTTING DOWN

MAIN BURNER ONLY (pilot will remain lit):

Turn the control knob clockwise to **PILOT**.

BURNER AND PILOT (total shutdown):

If you do not plan on using your burner system for an extended period (4 days or more), **you may extinguish the pilot.** This will conserve energy and save you money.

Push in the control knob slightly and turn clockwise to **OFF**.

PILOT BURNER CHECK/ADJUSTMENT

With the pilot burner lit and the control knob in the pilot position, check the pilot system for proper flame size and appearance (see Fig. 27-2). The pilot adjustment screw is located on the front of the gas valve (see Fig. 27-2). Using a small flat head screwdriver, adjust the pilot screw to properly size the flames. Turning the screw clockwise will lower the flames, and turning it counterclockwise will raise them. Be careful not to back the screw out of its threads.

The pilot flame should be a quiet, soft blue flame with yellow tipping that encircles the thermocouple tip.



Fig. 27-1 Control knob detail (ON)

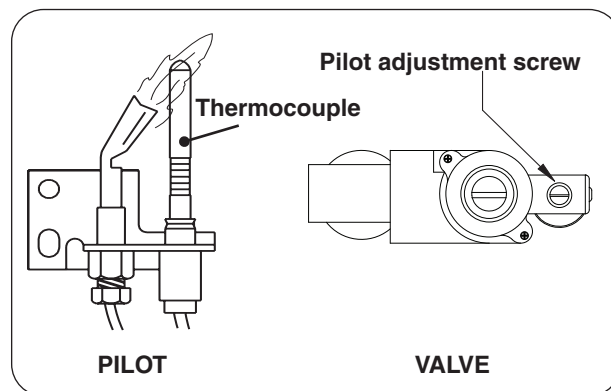

Fig. 27-2 Pilot adjustment detail

ALLUMER LE BRÛLEUR

1. Assurer la veilleuse est allumée. Tournez le bouton de contrôle du gaz dans le sens antihoraire sur **ON** (Fig. 28-3) pour allumer le brûleur. La vanne s'ouvre et le brûleur s'allume.

Note: La séquence d'allumage dure environ 5 secondes.

WARNING: Si le brûleur ne s'allume pas dans les 5 secondes, tournez le bouton de commande vers la droite pour **PILOT**. Permettre aux cinq (5) minutes pour tout gaz de l'unité de dissiper, puis répétez l'étape 1 ci-dessus. **SI VOUS UNE ODEUR DE GAZ, voir l'étape B AU DÉBUT DE instructions d'allumage.**

Si le brûleur ne s'allume pas après plusieurs tentatives, appuyez sur le bouton de commande et tournez légèrement à **OFF** et contactez un technicien qualifié.

ARRÊT

BRÛLEUR SEULEMENT (pilote reste allumé):

Tournez le bouton de commande vers la droite pour **PILOT**.

BRÛLEUR ET LA VEILLEUSE (arrêt total):

Si vous ne prévoyez pas d'utiliser votre système de brûleur pour une longue période (4 jours ou plus), **vous pouvez éteindre le pilote**. Ce sera de conserver l'énergie et économiser de l'argent.

Enfoncez légèrement le bouton de commande et tournez dans le sens horaire sur **OFF**.

VEILLEUSE CONTROLE/REGLAGE

Avec le brûleur de la veilleuse allumée et le bouton de commande dans le poste de pilotage, vérifier le système de pilotage de la taille de la flamme correspondant et l'apparence (voir Fig. 28-1). La vis de réglage de la veilleuse se trouve sur la face de la soupape à gaz (voir Fig. 28-1). L'aide d'un petit tournevis à tête plate, ajustez la vis de la veilleuse pour dimensionner correctement les flammes. Tourner la vis dans le sens horaire réduira les flammes, et en tournant dans le sens antihoraire leur suscitera. Veillez à ne pas desserrer la vis de ses fils.

La flamme de la veilleuse devrait être tranquille, flamme bleu pâle avec des pointes jaunes qui entoure la pointe du thermocouple.



Fig. 28-1 Détail bouton de commande (SUR)

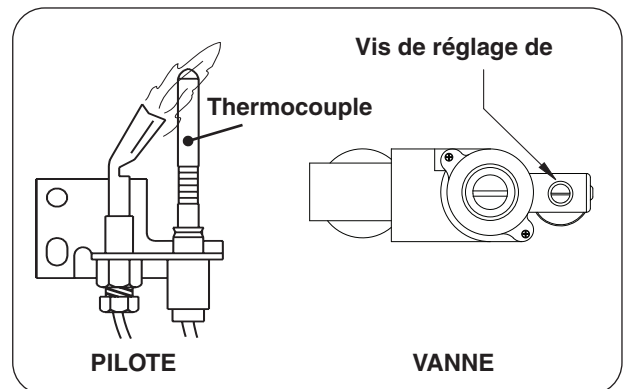

Fig. 28-2 Détail réglage de la veilleuse

LIGHTING INSTRUCTIONS - 02 SERIES

FOR YOUR SAFETY, READ BEFORE LIGHTING

WARNING: If you do not follow these instructions exactly, a fire or explosion may result causing property damage, personal injury or loss of life.

- A.** This appliance is equipped with an ignition device that automatically lights the pilot. DO NOT attempt to light the pilot by hand.
- B. BEFORE OPERATING,** smell all around the appliance area for gas. Be sure to smell next to the floor because some gas is heavier than air and will settle on the floor.

WHAT TO DO IF YOU SMELL GAS

- Do not light any appliance.
 - Do not touch any electric switch; do not use any phone in your building.
 - Immediately call your gas supplier from a neighbor's phone. Follow the gas supplier's instructions. If you cannot reach your gas supplier, call the fire department.
- C.** Use only the control system (or remote if equipped) to light the pilot. This valve will not operate if the pilot is not lit and stable.
- D.** Do not use this appliance if any part has been under water. Immediately call a qualified service technician to inspect the appliance and to replace any part of the control system and any gas control which has been under water. Attempted operation may result in fire or explosion resulting in property damage, personal injury or loss of life.

REMOTE LIGHTING (if equipped)

CAUTION: DO NOT attempt to light the pilot by hand.

Note: If the remote does not function, and batteries with an adequate power level are installed, refer to the SYNCING THE REMOTE section.

Note: Step 1 may not be required if previously done during an earlier lighting.

1. Locate the 3-position switch on the remote receiver (see Fig. 29-1), and slide the switch to the **REMOTE** position.

Note: For Switch Box Models, ensure that the ON/OFF switch at the front of the switch box is in the **OFF (O)** position.

2. Locate the remote transmitter and press the **ON** button (see Fig. 29-2). The ignition sequence will begin.

The remote receiver will emit an audible "beep"; then the igniter will begin to spark. After the pilot lights and is established, the valve will automatically open and the burner will light.

Note: The ignition sequence will take approximately 5 seconds.

WARNING: If the pilot fails to light within 5 seconds, or if the burner fails to light within 5 seconds of pilot lighting, press the OFF button on the remote transmitter and/or slide the switch to the OFF position. Allow five (5) minutes for any gas in the unit to dissipate, then repeat steps 1 and 2 above. IF YOU SMELL GAS, SEE STEP B ABOVE.

If the pilot fails to light after several tries, turn all control/remote system components to **OFF** and contact a qualified professional service technician.

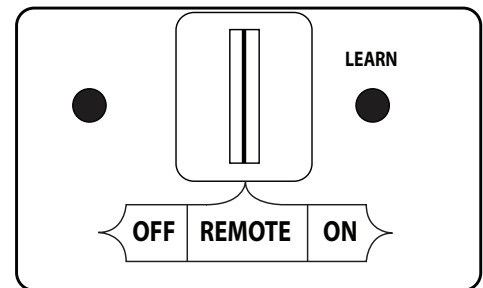

Fig. 29-1 Remote receiver detail (REMOTE)

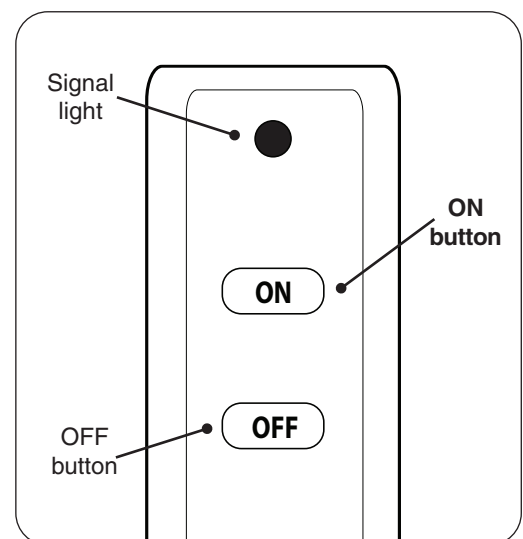

Fig. 29-2 Remote transmitter detail

INSTRUCTIONS D'ALLUMAGE - 02 SÉRIE

POUR VOTRE SÉCURITÉ LISEZ AVANT D'ALLUMER

AVERTISSEMENT: Si vous ne suivez pas ces instructions à la lettre, un incendie ou une explosion entraînant des dommages matériels, des blessures ou des pertes de vie.

A. Cet appareil est équipé d'un dispositif d'allumage qui allume automatiquement la veilleuse. NE PAS essayer d'allumer la veilleuse manuellement.

B. AVANT D'UTILISER, Sentez tout autour de l'appareil pour le gaz. Assurez-vous de sentir près du plancher, car certains gaz sont plus lourds que l'air et se déposent sur le sol.

QUE FAIRE SI UNE ODEUR DE GAZ

- Ne pas allumer l'appareil.
- Ne touchez à aucun interrupteur électrique; n'utilisez aucun téléphone dans votre bâtiment.
- Appelez immédiatement votre fournisseur de gaz à partir du téléphone d'un voisin. Suivez les instructions du fournisseur de gaz. Si vous ne pouvez joindre votre fournisseur de gaz, appeler les pompiers.

C. Utilisez uniquement le système de commande (ou à distance le cas échéant) pour allumer la veilleuse. Cette valve ne fonctionne pas si le pilote n'est pas éclairé et stable.

D. Ne pas utiliser cet appareil si une partie quelconque a été submergée. Appelez immédiatement un technicien de service qualifié pour inspecter l'appareil et pour remplacer toute pièce du système de contrôle et toute commande de gaz qui a été sous l'eau. Tentative d'opération peut entraîner un incendie ou une explosion entraînant des dommages matériels, des blessures ou des pertes de vie.

DISTANCE DE L'ÉCLAIRAGE (si équipée)

CAUTION: NE PAS essayer d'allumer la veilleuse à la main.

Note: Si la télécommande ne fonctionne pas, et des batteries avec un niveau de puissance adéquate sont installés, se référer à la section synchronisation des REMOTE (éloigné).

Note: Étape 1 ne peut être nécessaire si il a déjà fait lors d'un éclairage plus tôt.

1. Repérez l'interrupteur à 3 positions sur le récepteur de télécommande (voir Fig. 30-1), Et faites glisser le commutateur sur la position **REMOTE** (éloigné).

Note: Pour Boîte de commutateur modèles, veiller à ce que l'interrupteur ON/OFF (sur/éteindre) à l'avant de la boîte de commutation est en position **OFF (O)** (éteindre).

2. Localiser la télécommande et appuyez sur la touche **ON** (sur). Voir Fig. 30-2. La séquence d'allumage commence.

Le récepteur de télécommande émet un "bip" sonore; puis l'allumeur commence à susciter. Après les feux de pilotes et est établie, la vanne se ouvre automatiquement et le brûleur se allume.

Note: La séquence d'allumage prendra environ 5 secondes.

WARNING: Si la veilleuse ne s'allume pas dans les 5 secondes ou si le brûleur ne s'allume pas dans les 5 secondes suivant l'allumage de la veilleuse, appuyez sur le bouton OFF de la télécommande et / ou faites glisser le commutateur en position OFF. Autoriser cinq (5) minutes pour tout gaz dans l'unité à se dissiper, puis répétez les étapes 1 et 2 ci-dessus. SI VOUS UNE ODEUR DE GAZ, voir l'étape B ci-dessus.

Si le pilote ne se allume pas après plusieurs essais, tournez tous les composants système de contrôle / télécommande à **OFF** (éteindre) et contacter un technicien de service professionnel qualifié.

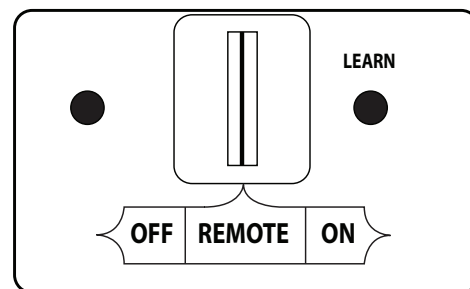

Fig. 30-1 Détail récepteur de télécommande (REMOTE)

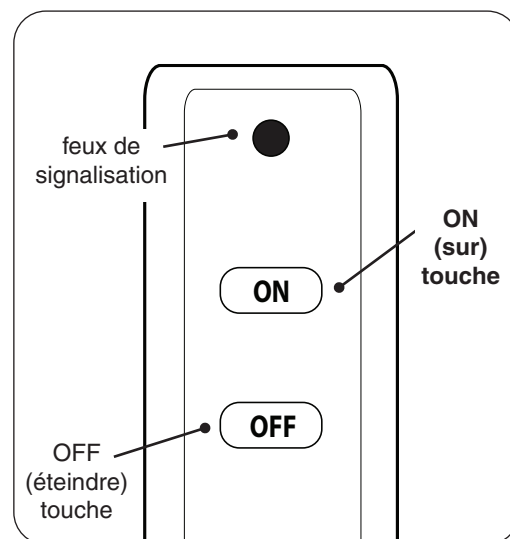

Fig. 30-2 Détail télécommande

MANUAL LIGHTING

CAUTION: DO NOT attempt to light the pilot by hand.

1. **Switch Box Models:** Locate the ON/OFF switch at the front of the switch box. Press the switch to the **ON (I)** position. See Fig. 31-1.

Remote Box Models: Locate the 3-position switch on the remote receiver (see Fig. 31-1), and slide the switch to the **ON** position.

The igniter will begin to spark. After the pilot lights and is established, the valve will automatically open and the burner will light.

Note: The ignition sequence will take approximately 5 seconds.

WARNING: If the pilot fails to light within 5 seconds, or the burner fails to light within 5 seconds of pilot lighting, slide the switch to the **OFF** position. Allow five (5) minutes for any gas in the unit to dissipate, then repeat step above. **IF YOU SMELL GAS, SEE STEP B AT BEGINNING OF LIGHTING INSTRUCTIONS.**

If the pilot fails to light after several tries, turn the system **OFF** and contact a qualified professional service technician.

Note: In manual mode, the remote transmitter will not operate the burner system.

SHUTTING DOWN

Switch Box Models

For remote shut down, press the **OFF** button on the remote transmitter.

For manual shutdown, press the ON/OFF switch at the front of the switch box to the **OFF (O)** position.

Important: Both the switch box ON/OFF switch and the remote control (if equipped) must be in the **OFF** position to shut the burner off. If one control is commanded off while the other is still on, the burner will remain on.

Remote Box Models

For remote shut down, press the **OFF** button on the remote transmitter.

If remote is unavailable, slide the switch on the remote receiver to the **OFF** position.

PILOT APPEARANCE

Periodically check the pilot for proper flame pattern. The pilot flame should encircle the generator tip, and is preset at the factory (see Fig. 31-2).

If the pilot flame burns incorrectly; shut down completely and contact a qualified professional service technician.

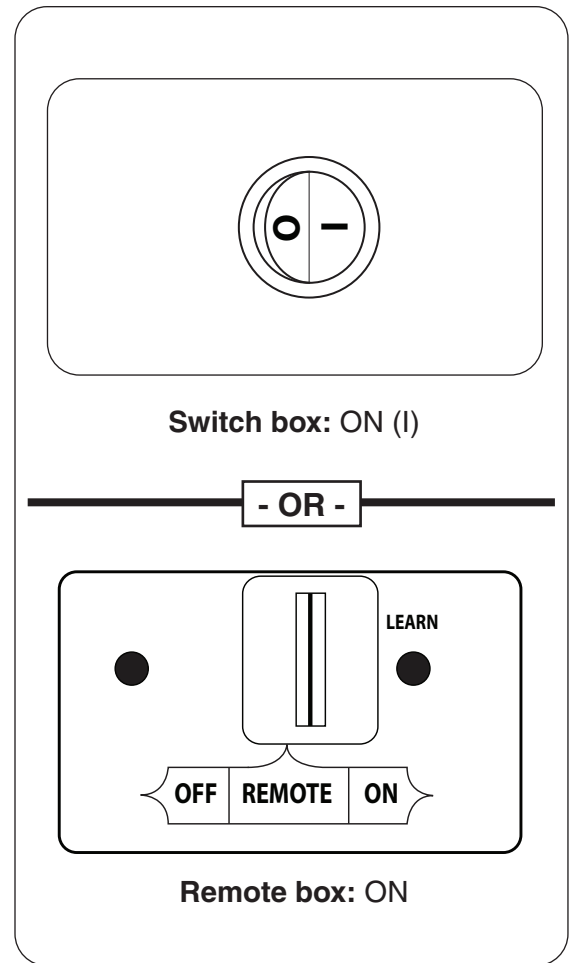

Fig. 31-1 Manual lighting

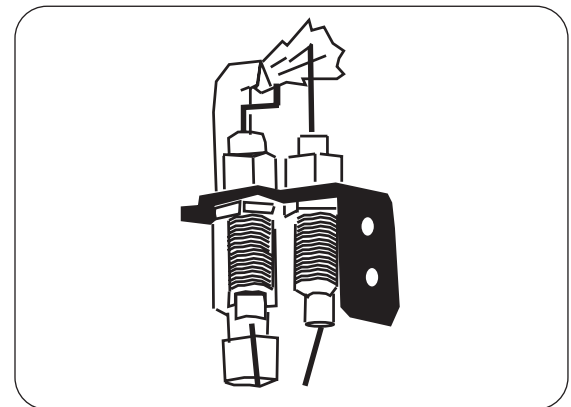

Fig. 31-2 Proper pilot flame

ÉCLAIRAGE MANUEL

CAUTION: NE PAS essayer d'allumer la veilleuse à la main.

1. Boîte De Commutateur Modèles: Repérez l'interrupteur ON/OFF (sur/éteindre) à l'avant de la boîte de commutation. Appuyez sur l'interrupteur sur la position **ON (I)** (sur). Voir Fig. 32-1.

Boîte À Distance Modèles: Situez l'interrupteur à 3 positions sur le récepteur à distance (voir la Fig.32-1.), Et faites glisser le commutateur à la position **ON** (sur).

L'allumeur commencera à s'allumer. Une fois que la veilleuse s'est allumée et est établie, la vanne s'ouvre automatiquement et le brûleur s'allume.

Note: La séquence d'allumage prendra environ 5 secondes.

WARNING: Si la veilleuse ne s'allume pas dans les 5 secondes ou si le brûleur ne s'allume pas dans les 5 secondes suivant l'allumage de la veilleuse, faites glisser le commutateur en position **OFF**. Autoriser cinq (5) minutes pour tout gaz dans l'unité à se dissiper, puis répétez l'étape ci-dessus. **SI VOUS UNE ODEUR DE GAZ, voir l'étape B AU DÉBUT DE INSTRUCTIONS D'ALLUMAGE.**

Si le pilote ne se allume pas après plusieurs essais, tournez le système **OFF** (éteindre) et contacter un technicien de service professionnel qualifié.

Note: En mode manuel, la télécommande ne fonctionnera pas le système du brûleur.

ARRÊT

Boîte De Commutateur Modèles

Pour arrêt à distance, appuyez sur le bouton **OFF** (éteindre) de la télécommande.

Pour un arrêt manuel, appuyez sur l'interrupteur ON/OFF (sur/éteindre) à l'avant de la boîte de commutation à la position **OFF (O)** (éteindre).

Tant la boîte de commutateur ON / OFF de l'interrupteur et la commande à distance (le cas échéant) doivent être en position OFF pour éteindre le brûleur. Si un contrôle est commandé hors tandis que l'autre est toujours allumé, le brûleur reste allumé.

Boîte À Distance Modèles

Pour arrêt à distance, appuyez sur le bouton **OFF** (éteindre) de la télécommande.

Si la télécommande ne est pas disponible, faites glisser le commutateur sur le récepteur de la télécommande à la position **OFF** (éteindre).

PILOT APPARENCE

Contrôler régulièrement le pilote pour motif de flamme correcte. La flamme de la veilleuse doit encercler la pointe du générateur, et est pré réglé en usine (voir Fig. 32-2).

Si la flamme de la veilleuse brûle mal; se arrêter complètement et contacter un technicien de service professionnel qualifié.

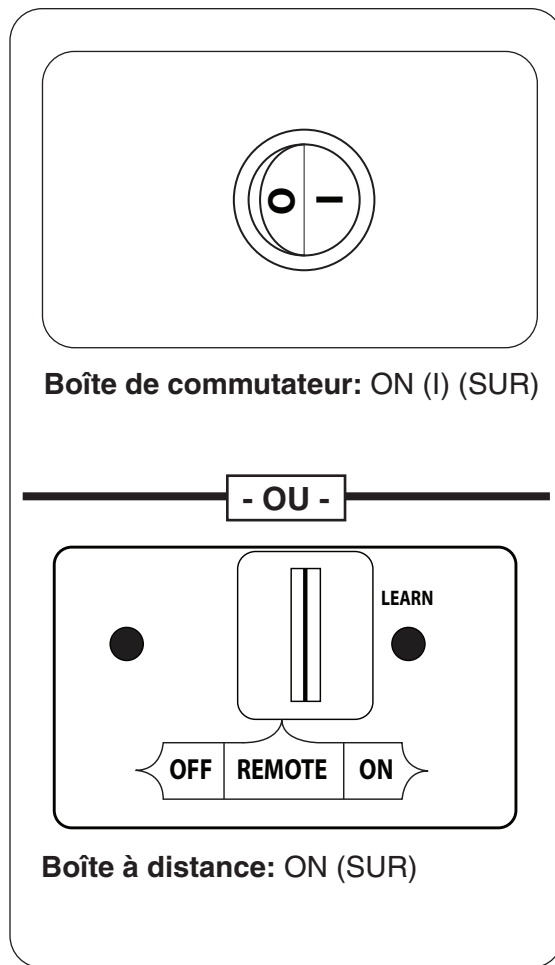

Fig. 32-1 Allumage manuel

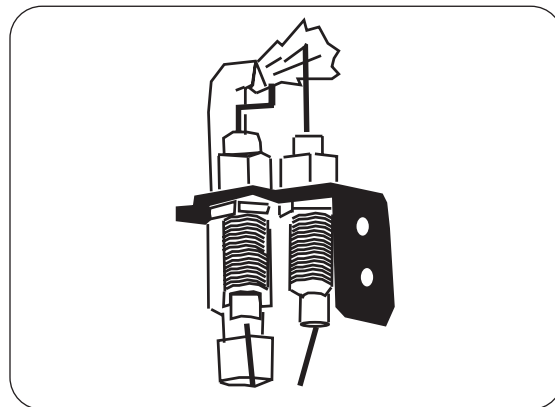

Fig. 32-2 Bonne flamme pilote

LIGHTING INSTRUCTIONS - 17 SERIES

FOR YOUR SAFETY, READ BEFORE LIGHTING

WARNING: If you do not follow these instructions exactly, a fire or explosion may result causing property damage, personal injury or loss of life.

- A. Use only your hand to push in or turn the gas control knob. Never use tools. If the knob will not push in or turn by hand, don't try to repair it. Call a qualified professional service technician. Excessive force or attempted repair may result in fire or explosion.
- B. **BEFORE OPERATING**, smell all around the appliance area for gas. Be sure to smell next to the floor because some gas is heavier than air and will settle on the floor.

WHAT TO DO IF YOU SMELL GAS

- Do not light any appliance.
 - Do not touch any electric switch; do not use any phone in your building.
 - Immediately call your gas supplier from a neighbor's phone. Follow the gas supplier's instructions. If you cannot reach your gas supplier, call the fire department.
- C. The burner system has a pilot that can be lit by hand using a long fireplace match or lighter. When lighting the pilot, follow these instructions exactly.
 - D. Do not use this appliance if any part has been under water. Immediately call a qualified service technician to inspect the appliance and to replace any part of the control system and any gas control which has been under water. Attempted operation may result in fire or explosion resulting in property damage, personal injury or loss of life.

LIGHTING THE PILOT

1. Locate the valve on the side of the unit. Push in the gas control knob slightly and turn clockwise to **OFF** (Fig. 33-1).

Note: The control knob cannot be turned from **PILOT** to **OFF** unless the knob is pushed in slightly. Do not force.

Allow five (5) minutes for any gas in the unit to dissipate. IF YOU SMELL GAS, SEE STEP B ABOVE. If you don't smell gas, go on to step 2.

2. Turn the control knob counterclockwise to **PILOT** (Fig. 33-1). Push the control knob **firmly and fully** in and hold. Hold a long fireplace match or lighter near the thermocouple to light the pilot. Continue to hold the control knob in for approximately 60 seconds after the pilot is lit, then release the knob. The pilot will remain lit.

WARNING: If the pilot fails to light repeat steps 1 and 2.

If the pilot fails to light after several tries, turn the control knob to **OFF** and contact a qualified professional service technician.

REMOTE LIGHTING (if equipped)

Note: If the remote does not function, and batteries with an adequate power level are installed, refer to the SYNCING THE REMOTE section.

Note: Step 1 may not be required if previously done during an earlier lighting.

1. Ensure the pilot is burning. Then locate the 3-position switch on the remote receiver (see Fig. 33-2), and slide the switch to the **REMOTE** position.

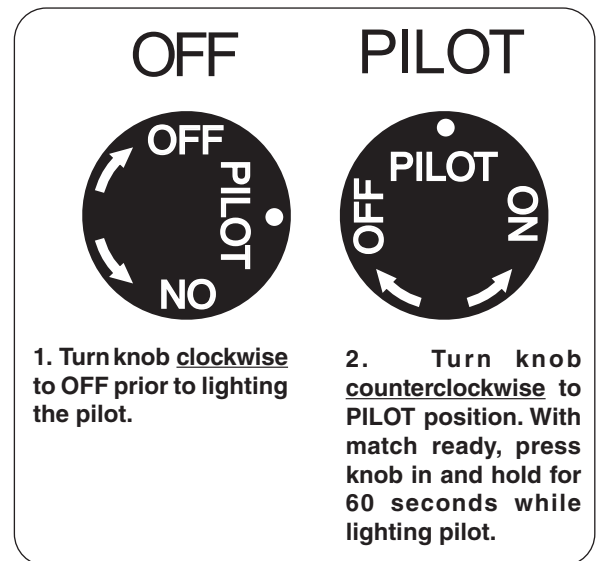

Fig. 33-1 Control knob detail (OFF, PILOT)

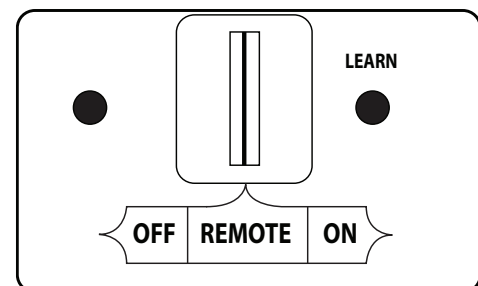

Fig. 33-2 Remote receiver detail (REMOTE)

INSTRUCTIONS D'ALLUMAGE - 17 SÉRIE

POUR VOTRE SÉCURITÉ, LISEZ AVANT D'ALLUMER

AVERTISSEMENT: Si vous ne suivez pas ces instructions à la lettre, un incendie ou une explosion entraînant des dommages matériels, des blessures ou des pertes de vie.

- A.** N'utilisez que votre main pour enfoncer ou tourner le bouton de contrôle du gaz. Ne jamais utiliser d'outils. Si le bouton ne sera pas enfoncer ou à tourner à la main, n'essayez pas de le réparer. Appelez un technicien de service qualifié. Une force excessive ou une tentative de réparation pourrait provoquer un incendie ou une explosion.
- B. AVANT DE FAIRE FONCTIONNER,** sentez autour de l'appareil pour le gaz. Assurez-vous de sentir près du plancher, car certains gaz sont plus lourds que l'air et se déposent sur le sol.

QUE FAIRE SI UNE ODEUR DE GAZ

- Ne pas allumer l'appareil.
 - Ne touchez à aucun interrupteur électrique; n'utilisez aucun téléphone dans votre bâtiment.
 - Appelez immédiatement votre fournisseur de gaz à partir du téléphone d'un voisin. Suivez les instructions du fournisseur de gaz. Si vous ne pouvez joindre votre fournisseur de gaz, appeler les pompiers.
- C.** Le système de brûleur a un pilote qui peut être allumée à la main à l'aide d'une allumette ou long cou léger. Pour allumer la veilleuse, suivez ces instructions à la lettre.
- D.** Ne pas utiliser cet appareil si une partie quelconque a été submergée. Appelez immédiatement un technicien de service qualifié pour inspecter l'appareil et pour remplacer toute pièce du système de contrôle et toute commande de gaz qui a été sous l'eau. Tentative d'opération peut entraîner un incendie ou une explosion entraînant des dommages matériels, des blessures ou des pertes de vie.

ALLUMAGE DE LA VEILLEUSE

1. Localiser la vanne sur le côté gauche de l'appareil. Appuyer sur le bouton de contrôle du gaz et tourner dans le sens horaire en position **OFF** (Fig. 34-1).

Note: Le bouton de commande ne peut être activée à partir **PILOTE** sur **OFF** si le bouton est enfoncé légèrement. Ne pas forcer.

Attendez cinq (5) minutes pour n'importe quel gaz dans l'unité de se dissiper. S'IL YA UNE ODEUR DE GAZ, voir l'étape B CI-DESSUS. Si vous ne sentez pas de gaz, passez à l'étape 2.

2. Tournez le bouton de réglage dans le sens antihoraire pour **PILOTE** (Fig. 34-1). Appuyez sur le bouton de commande **fermement et pleinement** enfoncée. Mantenga partido largo chimenea o un encendedor cerca del termopar a encender el piloto. Continúe a tenir le bouton de commande pendant environ 60 secondes après que le pilote est allumé, puis relâchez le bouton. Le pilote reste allumé.

AVERTISSEMENT: Si le pilote ne s'allume pas, répétez les étapes 1 et 2.

Si la télécommande ne fonctionne pas, et des batteries avec un niveau de puissance adéquate sont installés, reportez-vous à la synchronisation des section REMOTE.

DISTANCE DE L'ÉCLAIRAGE (le cas échéant)

Si la télécommande ne fonctionne pas, et que les batteries sont installées, reportez-vous à la synchronisation des section REMOTE.

Note: Étape 1 ne peut être exigé s'il a déjà été fait au cours d'un éclairage plus tôt.

1. Assurer la veilleuse est allumée. Ensuite, localisez le commutateur à 3 positions sur le récepteur de la télécommande (voir Fig. 34-2), Et faites glisser le commutateur sur la position **REMOTE**.

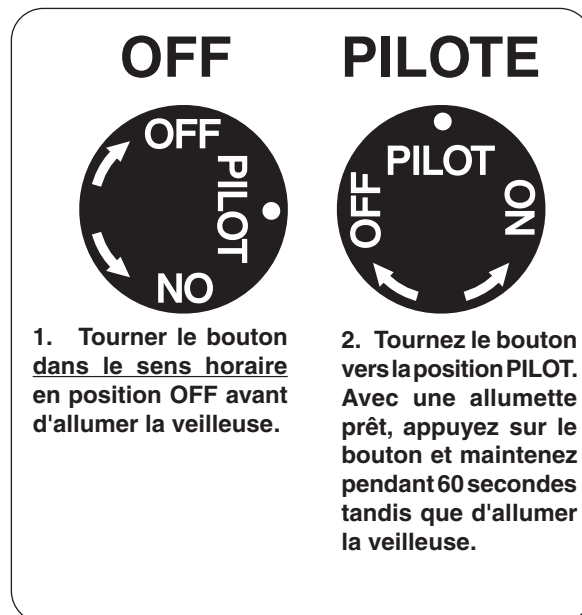

Fig. 34-1 Détail bouton de commande (OFF, PILOTE)

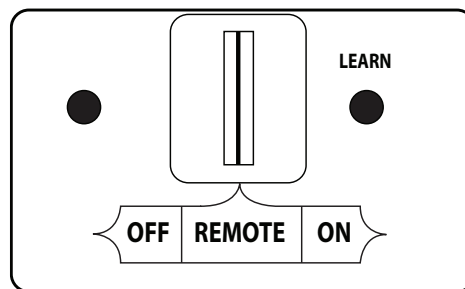

Fig. 34-2 Détail récepteur de télécommande (REMOTE)

2. Locate the remote transmitter and press and hold the **ON/HI** button (see Fig. 35-1). The ignition sequence will begin.

Note: Continue holding the button to increase the flame. A click will be heard when max flame height is reached.

Note: Upon initial use or after an extended period of no use, the **ON/HI** button may have to be pressed for up to 3 seconds prior to functioning.

The remote receiver will emit an audible "beep"; then the valve will automatically open and the burner will light. Adjust to the desired setting(s) with the remote transmitter. See the REMOTE OPERATING INSTRUCTIONS section for details.

Note: The ignition sequence will take approximately 5 seconds.

WARNING: If the burner fails to light within 5 seconds, press and hold the OFF button on the remote transmitter and/or slide the switch to the OFF position. Allow five (5) minutes for any gas in the unit to dissipate, then repeat steps 1 and 2 above. IF YOU SMELL GAS, SEE STEP B AT BEGINNING OF LIGHTING INSTRUCTIONS.

If the burner fails to light after several tries, turn all system components to **OFF** and contact a qualified professional service technician.

MANUAL LIGHTING

1. Ensure the pilot is burning. If equipped, locate the 3-position switch on the remote receiver (see Fig. 35-2), and slide the switch to the **OFF** position.
2. Turn the gas control knob counterclockwise to **ON** (Fig. 35-3) to ignite the burner. The valve will open and the burner will light.

Note: The ignition sequence will take approximately 5 seconds.

WARNING: If the burner fails to light within 5 seconds, turn the control knob clockwise to PILOT. Allow five (5) minutes for any gas in the unit to dissipate, then repeat step 2 above. IF YOU SMELL GAS, SEE STEP B AT BEGINNING OF LIGHTING INSTRUCTIONS.

If the burner fails to light after several tries, push in the control knob slightly and turn clockwise to **OFF**, and contact a qualified professional service technician.

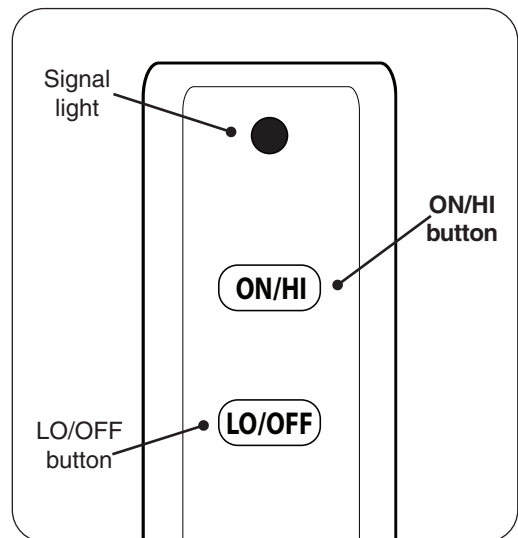

Fig. 35-1 Remote transmitter detail

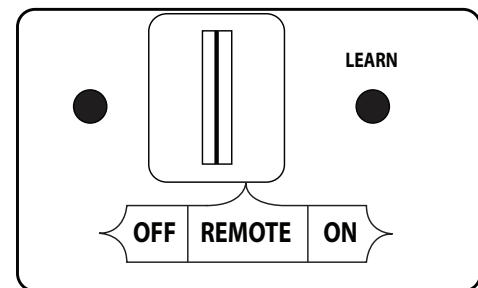

Fig. 35-2 Remote receiver (OFF for Manual Light)

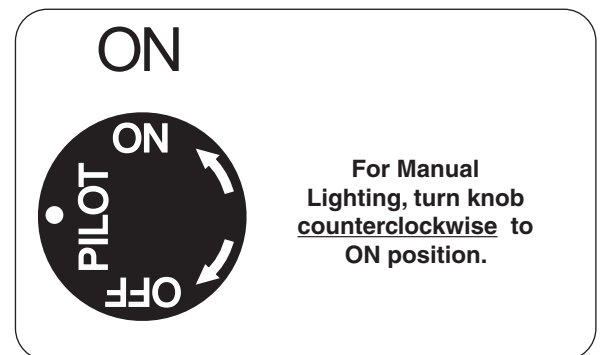

Fig. 35-3 Control knob detail (ON)

2. Localiser la télécommande et appuyez sur le touche **ON/HI** (voir Fig. 36-1). La séquence d'allumage commence.

Note: Continuez à maintenir le touche pour augmenter la flamme. Un clic se fait entendre lorsque la hauteur max de flamme est atteinte.

Note: Dès la première utilisation ou après une longue période de non utilisation, le touche **ON/HI** peut être pressée pour 3 secondes avant de fonctionnement.

Le récepteur de la télécommande émettra un «bip» sonore, puis la vanne s'ouvre automatiquement et le brûleur s'allume. Choisissez le réglage souhaité(s) avec la télécommande. Voir la section INSTRUCTIONS DE FONCTIONNEMENT A DISTANCE pour plus de détails.

Note: La séquence d'allumage dure environ 5 secondes.

WARNING: Si le brûleur ne s'allume pas dans les 5 secondes, appuyez et maintenez le bouton OFF de la télécommande et / ou faites glisser le commutateur à la position OFF. Permettre aux cinq (5) minutes pour tout gaz dans l'unité à se dissiper, puis répétez les étapes 1 et 2 ci-dessus. **SI VOUS UNE ODEUR DE GAZ, voir l'étape B AU DÉBUT DE DIRECTIVES D'ALLUMAGE.**

Si le brûleur ne s'allume pas après plusieurs essais, tournez tous les composants du système à **OFF** et contactez un technicien qualifié.

ALLUMAGE MANUEL

1. Assurer la veilleuse est allumée. Si vous êtes équipé, localisez le commutateur à 3 positions sur le récepteur de la télécommande (voir Fig. 36-2), Et faites glisser le commutateur sur la position **OFF**.

2. Tournez le bouton de contrôle du gaz dans le sens antihoraire sur **ON** (Fig. 36-3) pour allumer le brûleur. La vanne s'ouvre et le brûleur s'allume.

Note: La séquence d'allumage dure environ 5 secondes.

WARNING: Si le brûleur ne s'allume pas dans les 5 secondes, tournez le bouton de commande vers la droite pour **PILOT**. Permettre aux cinq (5) minutes pour tout gaz de l'unité de dissiper, puis répétez l'étape 2 ci-dessus. **SI VOUS UNE ODEUR DE GAZ, voir l'étape B AU DÉBUT DE instructions d'allumage.**

Si le brûleur ne s'allume pas après plusieurs tentatives, appuyez sur le bouton de commande et tournez légèrement à **OFF** et contactez un technicien qualifié.

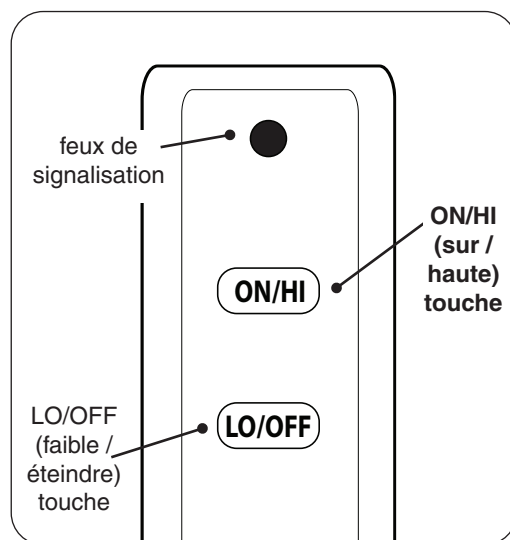

Fig. 36-1 Détail télécommande

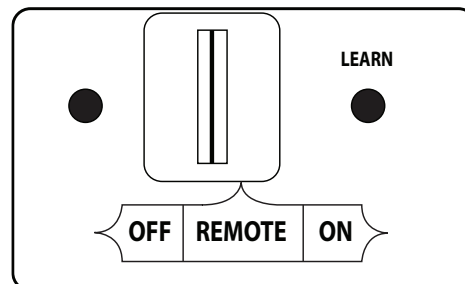

Fig. 36-2 Récepteur de la télécommander (OFF pour Light Manuel)



Fig. 36-3 Détail bouton de commande (SUR)

SHUTTING DOWN

MAIN BURNER ONLY (pilot will remain lit):

For remote shut down, press and hold the **LO/OFF** button on the remote transmitter until the burner shuts off. **If remote is unavailable**, slide the switch on the receiver to the **OFF** position. For manual shutdown, turn the control knob clockwise to **PILOT**.

BURNER AND PILOT (total shutdown):

If you do not plan on using your burner system for an extended period (4 days or more), **you may extinguish the pilot**. This will conserve energy and save you money.

Push in the control knob slightly and turn clockwise to **OFF**.

PILOT BURNER CHECK/ADJUSTMENT

With the pilot burner lit and the control knob in the pilot position, check the pilot system for proper flame size and appearance (see Fig. 37-1). The pilot adjustment screw is located on the front of the gas valve (see Fig. 37-1). Using a small flat head screwdriver, adjust the pilot screw to properly size the flames. Turning the screw clockwise will lower the flames, and turning it counterclockwise will raise them. Be careful not to back the screw out of its threads.

The pilot flame should be a quiet, soft blue flame with yellow tipping that encircles the thermocouple tip.

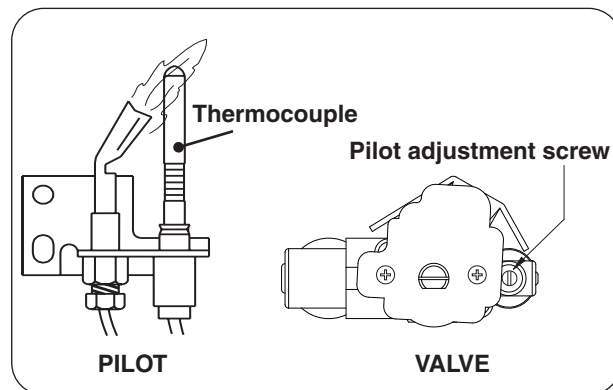

Fig. 37-1 Pilot adjustment detail

REMOTE OPERATING INSTRUCTIONS - 17 SERIES

ORIENTATION

Note: If the remote does not function, and batteries with an adequate power level are installed, refer to the SYNCING THE REMOTE section.

Prior to remote transmitter use, light the appliance per the REMOTE LIGHTING section. Familiarize yourself with the transmitter buttons, as illustrated in Fig. 37-2.

Identify the transmitter buttons:

- **ON/HI BUTTON:** This button turns the burner ON (when the pilot is lit), and increases the flame height.
- **LO/OFF BUTTON:** This button decreases the flame height and turns the burner OFF (pilot will remain lit).

FLAME HEIGHT

The flame height may be adjusted via the remote transmitter. Press and hold the **ON/HI** button to increase the flame height. Press and hold the **LO/OFF** button to decrease the flame height. A click will be heard when the max/minimum setting is reached.

Note: Continuing to hold the **LO/OFF** button will turn off the burner. The pilot will remain lit.

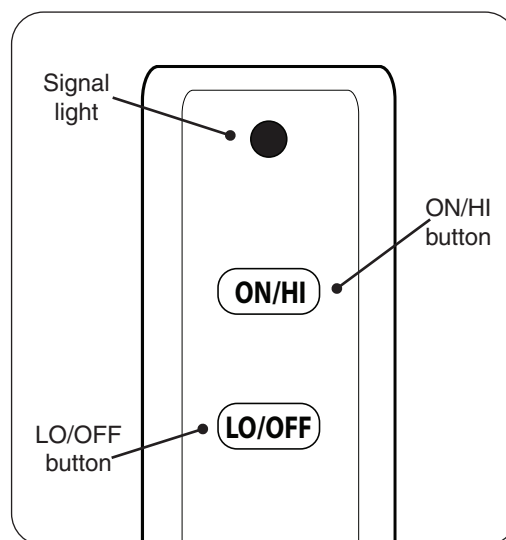

Fig. 37-2 Remote transmitter detail

FERMER

BRÛLEUR SEULEMENT (pilote reste allumé):

Pour arrêt à distance, appuyez et maintenez le bouton **LO / OFF** sur la télécommande jusqu'à ce que le brûleur est éteint. Si la télécommande n'est pas disponible, faites glisser le commutateur sur le récepteur à la position **OFF**. Pour un arrêt manuel, tournez le bouton de commande vers la droite pour **PILOT**.

BRÛLEUR ET LA VEILLEUSE (arrêt total):

Si vous ne prévoyez pas d'utiliser votre système de brûleur pour une longue période (4 jours ou plus), vous pouvez éteindre le pilote. Ce sera de conserver l'énergie et économiser de l'argent.

Appuyer sur le bouton de commande légèrement et tournez dans le sens horaire sur **OFF**.

VEILLEUSE CONTROLE/REGLAGE

Avec le brûleur de la veilleuse allumée et le bouton de commande dans le poste de pilotage, vérifier le système de pilotage de la taille de la flamme correspondant et l'apparence (voir Fig. 38-1). La vis de réglage de la veilleuse se trouve sur la face de la soupape à gaz (voir Fig. 38-1). L'aide d'un petit tournevis à tête plate, ajustez la vis de la veilleuse pour dimensionner correctement les flammes. Tourner la vis dans le sens horaire réduira les flammes, et en tournant dans le sens antihoraire leur suscitera. Veillez à ne pas desserrer la vis de ses fils.

La flamme de la veilleuse devrait être tranquille, flamme bleu pâle avec des pointes jaunes qui entoure la pointe du thermocouple.

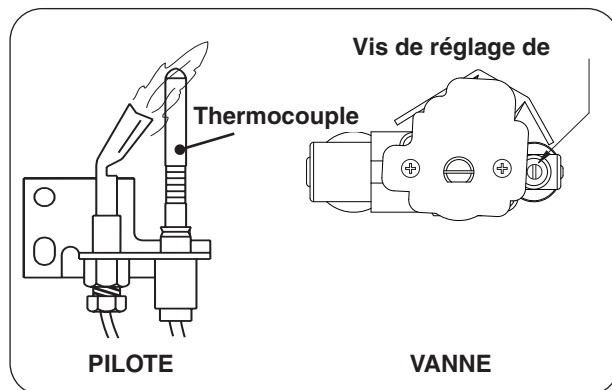

Fig. 38-1 Détail réglage de la veilleuse

MODE D'EMPLOI À DISTANCE - 17 SÉRIE

ORIENTATION

Si la télécommande ne fonctionne pas, et des batteries avec un niveau de puissance adéquate sont installés, reportez-vous à la synchronisation des section REMOTE.

Avant l'utilisation de télécommande, allumer l'appareil par la section de distance de l'éclairage. Familiarisez-vous avec les touches de l'émetteur, comme illustré sur la Fig. 38-2.

Identifier les touches de l'émetteur:

- **TOUCHE ON/HI:** Ce touche active le brûleur ON (lorsque le pilote est allumé), et augmente la hauteur de la flamme.
- **TOUCHE LO/OFF:** Cette touche permet de diminuer la hauteur des flammes et éteindre l'brûleur (pilote reste allumé).

HAUTEUR DE LA FLAMME

La hauteur de flamme peut être ajustée via la télécommande. Appuyez et maintenez enfoncé le touche **ON/HI** pour augmenter la hauteur de la flamme. Appuyez et maintenez le touche **LO/OFF** pour diminuer la hauteur des flammes. Un clic se fait entendre lorsque le réglage max / minimum est atteint.

Note: En continuant à maintenir le touche **LO/OFF** permet d'éteindre le brûleur. Le pilote restera allumé.

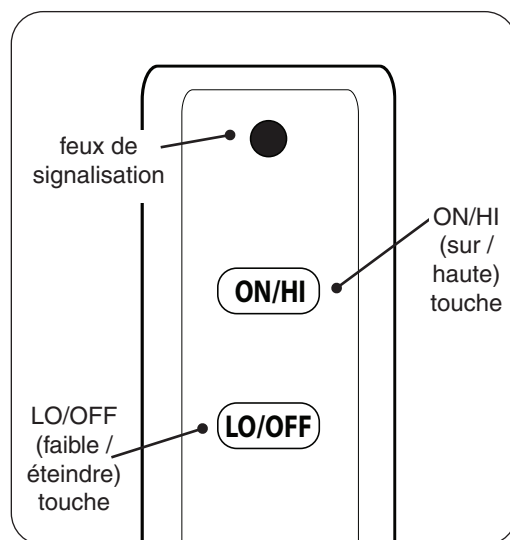

Fig. 38-2 Détail télécommande

CLEANING AND SERVICING

Note: Discoloration is common on the grate after burning.

Note: Servicing may be necessary to ensure proper pilot operation and proper burn characteristics.

Always shut off the gas to the appliance while performing service work.

Allow the appliance to cool before servicing.

Installation, service, and repair must be done by an NFI Certified or other qualified professional service technician. The appliance should be examined before use, and must be inspected at least annually to prevent burner shutdown, sooting, odors, etc. It must be checked for clean burning operation and proper pilot appearance, with the correct tools to service this unit. More frequent servicing may be required. It is imperative that all control components and compartments, burner(s), air shutters, and circulating air passageways of the appliance be kept clean and free of all obstructions (as applicable).

In addition, a periodic examination and cleaning of the solid-fuel-burning fireplace venting system should be conducted by a qualified professional service technician.

Any safety screen or guard removed for servicing must be replaced prior to operating this appliance.

Replace batteries as needed. See INSTALLING/REPLACING BATTERIES section for details.

Verify proper operation after servicing.

If, after a period of use, the flames start to exhibit unusual shapes and behavior, or the burners fail to ignite smoothly, the burner may require cleaning or servicing. If this happens, it is recommended to contact the nearest dealer to get the appliance serviced.

Do not remove the rating plates or the warning tags. These are an integral safety and identification component of this appliance.

We recommend following these instructions at the beginning of each fireplace season and as needed throughout the year, depending on your usage pattern and the environmental conditions in your home. More frequent cleaning and maintenance may be necessary when burning propane gas than with natural gas.

SYNCING THE REMOTE SYSTEM (if applicable)

Ensure the burner system is off and completely cool.

Locate the 3-position switch on the remote receiver and slide it to the **REMOTE** position. Use the tip of a pen or a wire clip to push the **LEARN** button and release. See Fig. 40-1. A beep will be heard. Then press and hold the **ON** or **ON/HI** button on the remote transmitter; a series of beeps should be heard. The remote system is now synced. Refer to the LIGHTING INSTRUCTIONS to test.

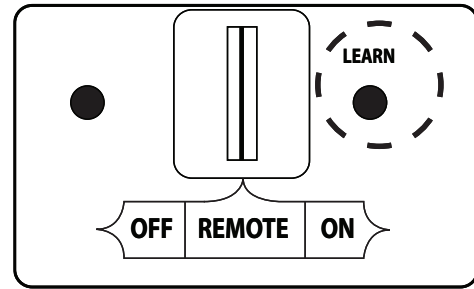

Fig. 40-1 Remote receiver sync detail

FLAME DESCRIPTION

Observe the flames. The main burner flames should be blue at the base and a combination of blue/yellow at the body and at the tips. They should be approximately the same height at the tallest log, with the center flame being the tallest. The ember flames should be 1/4" above the embers (See 40-2 for example.)



Fig. 40-2 Flame appearance

TROUBLESHOOTING

POSSIBLE CAUSE	SOLUTIONS
1 BURNER SHUTTING DOWN DURING OPERATION	
A. Insufficient or excessive gas pressure	A1. Check gas pressure (Read D.- F. of IMPORTANT PRE-INSTALLATION AND FIREPLACE SAFETY INFORMATION section, & check with local gas company). A2. Other gas appliances may be on the same gas line, dropping gas pressure to log set. Check pressures with everything operating to ensure adequate pressure.
B. Log placement	B. Reference the LOG PLACEMENT section in this manual for recommended log positioning.
C. Flue area, fireplace, or damper dirty from soot	C. Clean around, above, and under damper thoroughly. Clean fireplace, removing loose material, including soot and creosote.
D. Fireplace too small for unit	D. Ensure minimum requirements are met (see SPECIFICATIONS section).
E. Pilot flame lifting off thermocouple/generator	E. Check gas pressure (see section A1).
F. Pilot (remote compatible)	F. Contact your dealer for instructions on replacement.
G. Blockages on burner	G. Vacuum any lava granules or material that may have fallen onto burner port area.
2 PILOT WILL NOT LIGHT	
A. Pilot flame lifting off thermocouple/generator	A. Check gas pressure (see Section 1, A1 of this table).
B. Electronic spark not lighting pilot	B. Check to ensure sparking when activated. Note: You may need to turn or press igniter several times to ignite pilot. See LIGHTING INSTRUCTIONS for your control valve.
C. Igniter electrode wire loose	C. Check wiring and reconnect any loose wiring.
D. Gas supply off/manual shutoff valve closed	D. Turn on gas supply or open manual shutoff valve.
E. Air in gas line	E. Bleed gas supply line and repeat LIGHTING INSTRUCTIONS until air is removed.
F. Pilot hood blocked	F. Check for debris or dirt / Clean pilot
G. Dead batteries (if applicable)	G. Replace batteries as needed.
3 LOW FLAME HEIGHT	
A. Gas pressure	A. Check gas pressure (see Section 1, A1 of this table).
B. Valve not fully open	B. Open valve fully.
C. Blockage or kink in flex connector kit, plumbing, or burner orifice	C. Clean out blockage. If flex connector is kinked, replace it.
D. Remote set on low flame (if option available)	D. Adjust flame with remote transmitter.
E. Incorrect media (sand or vermiculite) for gas type	E. Contact dealer for proper media (sand or vermiculite).
4 BURNER NOT BURNING EVENLY	
A. Burner ports clogged	A. Clean burner ports.
B. Media may be packed down too tightly	B. Loosen media around burner pipe by running a flathead screwdriver along both sides of the pipe. Even out media in burner pan.

TROUBLESHOOTING (Cont.)

POSSIBLE CAUSE	SOLUTIONS
----------------	-----------

5

ODORS

A. Gas leak	A. Shut off gas, if possible. Follow instructions on front page. Have a qualified professional installer or the gas company correct all leaks.
B. New home, new carpet, or new paint	B. When these odors are drawn into the fireplace, this may cause objectionable odors. Thoroughly ventilate the area before restarting your log set.
C. Damper closed	C. Ensure that damper is open.

6

SMOKING AND/OR SOOTING

A. Poor draft or downdraft	A. Check for chimney blockage. Be sure chimney is at least 3' taller than anything within 10' of it in all directions. If not, consult a chimney sweep. A chimney cap or fan may help.
B. Damper closed	B. Ensure that damper is open.
C. Burner is positioned too close to front of firebox	C. Move burner system to the center of the firebox.
D. Improper media placement	D. See INSTALLATION section for proper media placement.
E. Air mixer on propane set closed (if applicable)	E. Open air mixer completely.
F. Air shutters blocked (if applicable)	F. Air shutters are blocked with debris. Vacuum debris away from air shutter.
G. Log placement	G. See solution in Section 1, B.
H. Using natural-gas burner on propane gas or propane burner on natural gas	H. If gas listed on nameplate does not match gas you are burning, shut down burner system immediately. Call dealer.
I. Adding any accessories to burner system	I. Shut down burner system and take off any accessories that do not belong with the system.

7

PILOT WILL NOT STAY LIT

A. Valve won't hold	A. Contact your dealer for instructions on replacement.
B. Pilot hood not aimed at thermocouple	B. Pilot hood bent; replace pilot or angle pilot hood properly so pilot flame hits thermocouple.
C. Pilot line bent / kinked at connection to valve	C. Replace pilot line.
D. Thermocouple is loose	D. Tighten thermocouple nut at gas control valve. (Do not over tighten.)
E. Thermocouple cracked or worn out	E. Replace thermocouple.
F. Excessive down draft	F. Install chimney cap / Outside chimney too close to other peaks / Check chimney flue for proper height / Poorly designed chimney.

8

BURNER WILL NOT TURN ON

A. Low/dead batteries in remote transmitter AND/OR switch/receiver box (if applicable)	A. Replace batteries as needed.
--	---------------------------------

9

FLAME AT AIR MIX / ORIFICE (PROPANE MODELS)

A. Burner ports clogged	A. Clean burner ports.
B. Gas pressure	B. Check gas pressure (see Section 1, A1 of this table).
C. Incorrect media for propane gas and/or media may be packed down too tightly	C. Ensure proper vermiculite media is used with propane gas. Loosen media around burner pipe by running a flathead screwdriver along both sides of pipe. Even out media in pan.

Detail A

Electrode (A)

When adjusting the spark electrode (if necessary); NEVER adjust the electrode by bending the wire. ALWAYS adjust the electrode by loosening the retainer nut(s), then adjust accordingly.

The minimum gap between the spark electrode/heat sensor and the pilot flame hood is 1/8". The maximum is 5/32".

If the electrode ceramic is loose in the threaded barrel; the pilot assembly must be replaced.

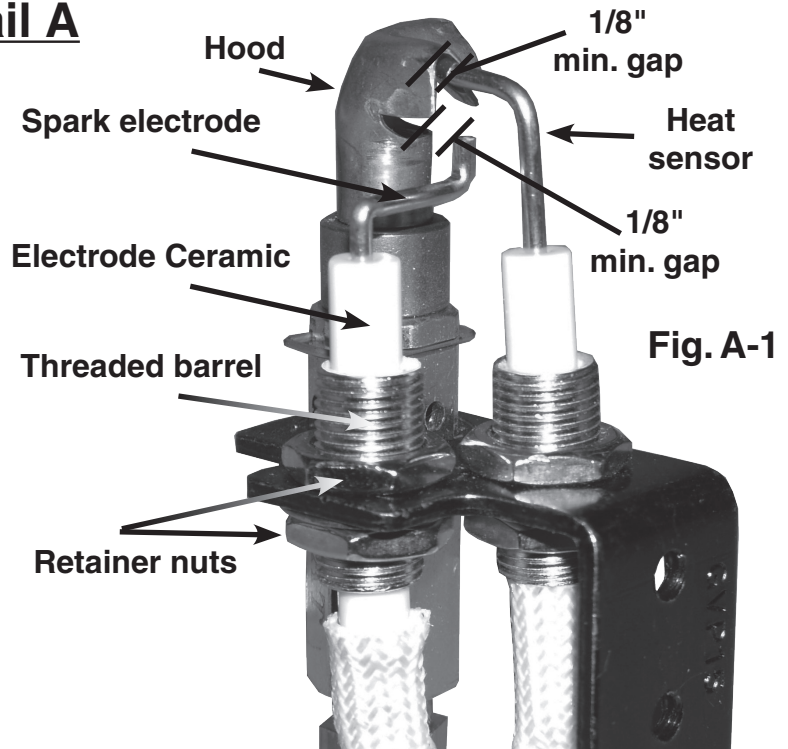

Fig. A-1

Detail B

Terminal Connections (B)

All of the connections on the control module must be properly attached. If the spade terminals are loose; inspect to ensure they correctly appear as detailed below. Use needle nose pliers to clamp down on the center/sides of the terminals if needed (to provide a tight fit.) See Fig B-3 below.

Spade Terminal Detail



Ensure that spade terminals (S and I) are attached securely

Ensure that multi-wire connector is properly engaged

Control Module (DESIGN MAY VARY) (Fig. B-2)

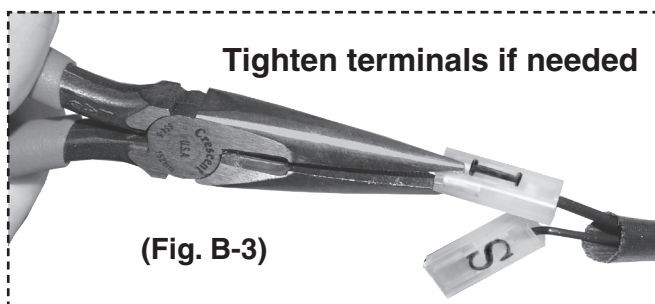
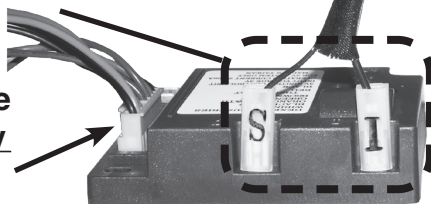

(Fig. B-3)

Detail C

(Fig. C-1)

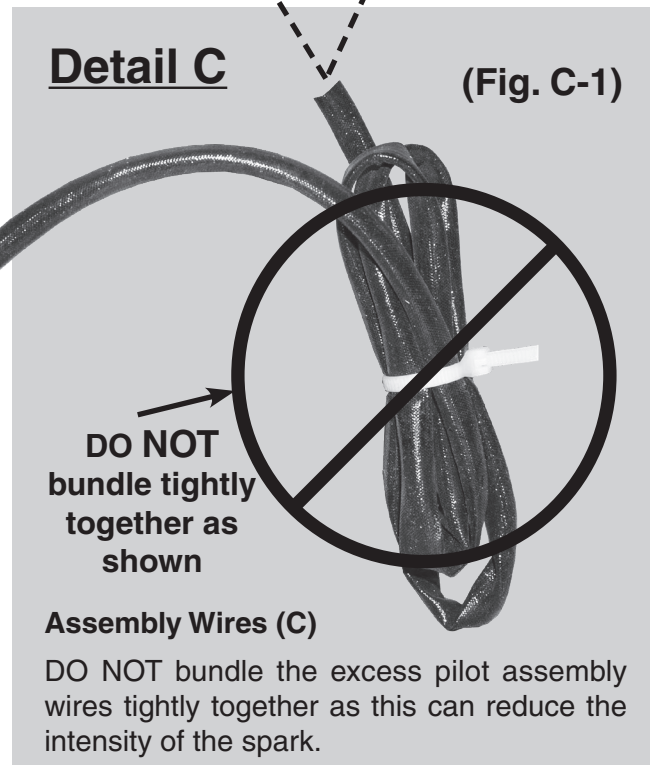

WARRANTY

PETERSON INDOOR VENTED DECORATIVE GAS APPLIANCE LIMITED WARRANTY

Robert H. Peterson Co. ("RHP") warrants your Real Fyre® vented decorative gas appliance to be free from defects in material and workmanship. This warranty is for indoor use only.

Peterson vented ceramic refractory gas logs are warranted for **as long as you own them (lifetime)**.

Peterson vented burner assemblies excluding valves, pilots, and controls are **WARRANTED for TEN (10) YEARS**.

Peterson glass, gems, nuggets, and fiber-ceramic blend gas logs are warranted for **FIVE (5) YEARS**.

SPK-26 controls are warranted for **THREE (3) YEARS**.

APK-17 controls (including -17 valve) are warranted for **TWO (2) YEARS**.

All other Peterson valves, pilots, and controls are warranted for **ONE (1) YEAR (excluding batteries)**.

A COPY OF YOUR SALES SLIP FOR PROOF OF PURCHASE IS REQUIRED

This warranty applies to the original purchaser for products which are installed in the United States or Canada and which are operated and maintained as intended for single family residential usage. This warranty is valid only with proof of purchase, commence on the date of purchase, and terminates (both as to original and any replacement products) on the anniversary date of the original purchase of the product per the above schedules.

This warranty covers defects in material and workmanship. This warranty **does not** cover parts which become defective as a result of negligence, misuse, use not in compliance with the Installation and Owner's Manual, accidental damage, improper handling, improper storage, improper installation, **lack of required routine maintenance** (as specified in the Installation and Owner's Manual), or electrical damage. Product must be installed as specified in the Installation and Owner's Manual by a **qualified professional installer**. Modifications to products which are not specifically authorized will void this warranty. Accessories, parts, valves, remotes, etc. when used must be Peterson products or this warranty is void. Warranted items will be repaired or replaced at Peterson's sole discretion. This warranty **does not** apply to rust, corrosion, oxidation, or discoloration unless the affected part becomes inoperable.

This warranty **does not** cover labor or labor related charges, except as provided by separate specific written programs from the Peterson Co. All repair work must be performed by a qualified professional service person and requires prior approval of Peterson.

Peterson may require the defective product or part to be returned to the factory to determine the cause of failure. Peterson will pay freight charges if the product or part is determined to be defective. This warranty does not cover breakage in shipment from our (Independent) distributor to its customer if the damage is determined to have occurred during that shipment.

This warranty specifically excludes liability for **indirect, incidental**, or consequential damages. Some states and provinces do not allow the exclusion or limitation of incidental or consequential damages, so the above exclusion may not apply to you. This warranty gives you specified legal rights, and you may have other rights that vary from state to state or province.

For additional information regarding this warranty, or to place a warranty claim, contact the R. H. Peterson dealer where the product was purchased.

When contacting your Peterson dealer or the R. H. Peterson Co., please provide the following information:

- Your name, address, telephone number, e-mail
- Sales receipt showing where purchased and date purchased
- Model number, serial number of product, date code
- Relevant information: installer, additions, repairs, when defect was first noted

**TO REGISTER YOUR PRODUCT ONLINE GO TO: WWW.RHPETERSON.COM,
AND CLICK ON PRODUCT REGISTRATION. THANK YOU FOR YOUR PURCHASE.**

Quality Check			Date: _____		
Burner Orifices	Nat.	L.P.	Leak Test: _____	Model#:	_____
Main:	_____	_____	Burn Test: _____	Serial#:	_____
Other:	_____	_____	Gas Type: <u>Nat. / L.P.</u>	Air Shutter:	_____
				Inspector:	_____