

# ELECTRIC FIREPLACE SERIES

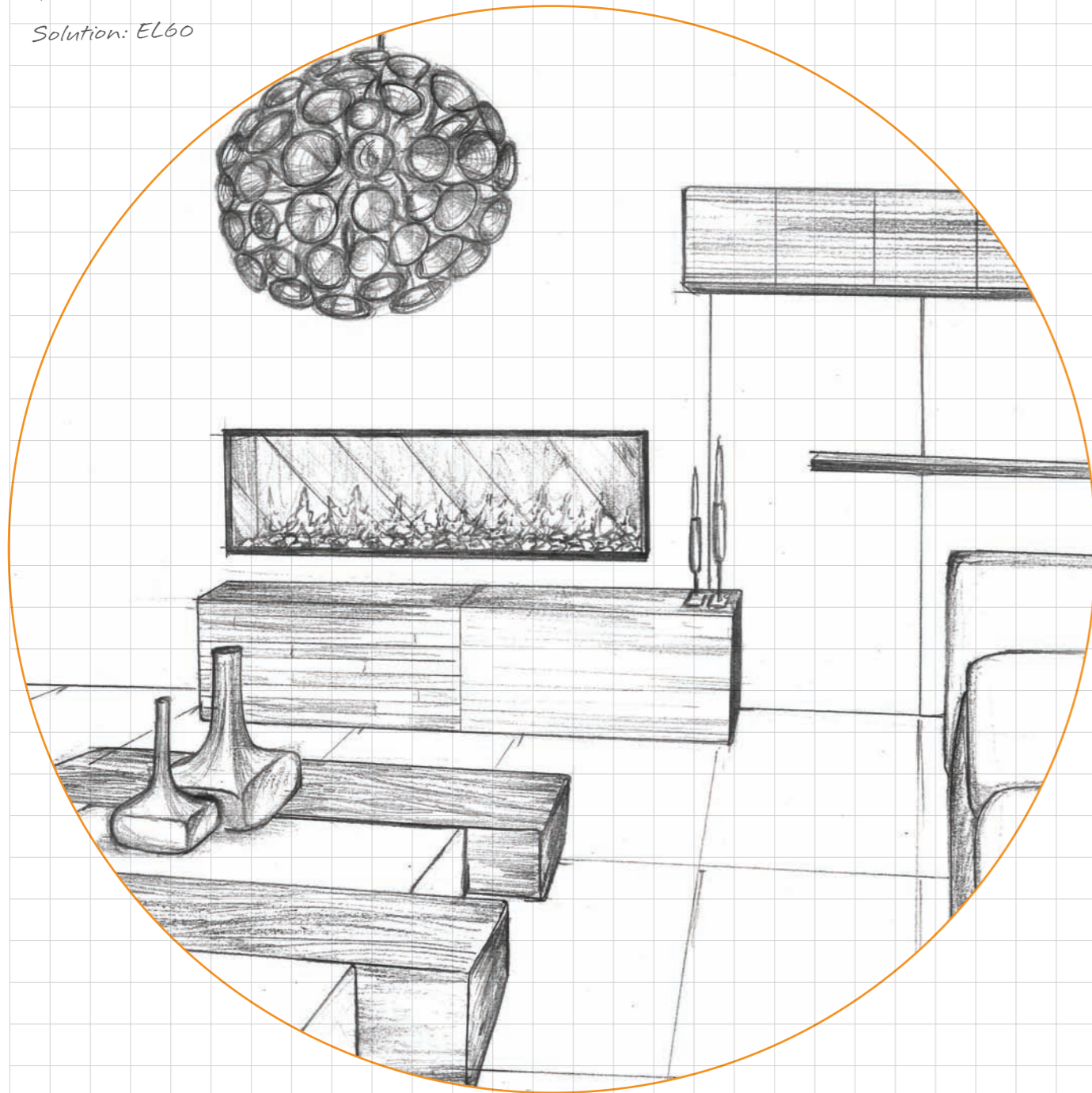

*Brief: Introduce a lifelike  
flame with adjustable heat  
options to enjoy year round.*

*Solution: EL60*



# WE HAVE YOUR ELECTRIC FIREPLACE SOLUTION

## Linear Solutions

EcoSmart Fire's Electric Series provides builders, architects, designers and homeowners with a realistic flame solution that can be easily installed in residential and commercial spaces at a fraction of the operating costs when compared to gas or wood fireplaces.

The built-in, flush mounted design results in unlimited design freedom and installation flexibility, while remote control convenience allows you to instantly light the fireplace, adjust heat, change from orange to blue flame and turn it off with a simple press of a button.



# ELECTRIC FIREPLACE SERIES

Available in five different lengths ranging from 1,015mm [40"] to 3,050mm [120"], the Electric Series is designed for all room sizes from residential to commercial environments.

## EL40

Minimum Wall Length 1,525mm [60in]



## EL60

Minimum Wall Length 2,030mm [80in]



## EL80

Minimum Wall Length 3,050mm [100in]



## EL100

Minimum Wall Length 2,915mm [120in]



## EL120

Minimum Wall Length 3,555mm [140in]



# APPLICATION EXAMPLES

Electric's sleek, long lines and captivating smoke-free flame provides a stunning focal point that brings warmth and ambiance to indoor settings.

## RESTAURANTS



## BEDROOMS

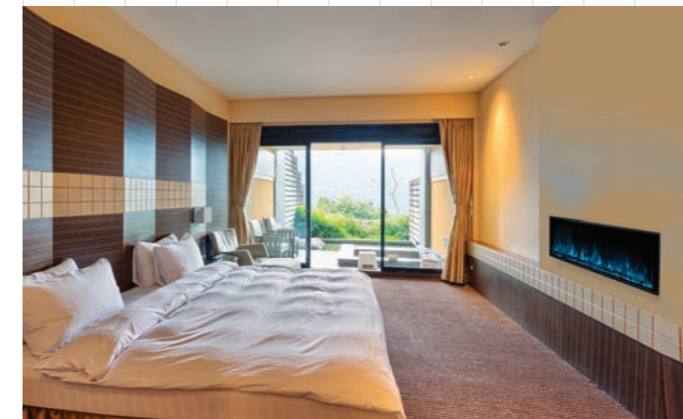

## LOBBIES



## RETIREMENT HOMES



## LIVING SPACES



# ELECTRIC FIREPLACE FEATURES

Requiring no gas, no venting, and no hole in the envelope, Electric Series is ideal for new construction or remodel.

## ETL Listed

Our Electric Fireplaces are ETL Listed.



## Decorative Logs

Optional decorative log set is available for each Electric model to provide a more traditional burn to your contemporary shaped fireplace.

## Glass Media

Included decorative glass media.



## High-tech Touch Screen

An LED touch screen - included with each Electric model - is easily mountable to the wall and provides ability to turn on/off, adjust from a raging fire to ambient backlighting, adjust heat settings and change from orange to blue flame.



## Easy Install

Requires no hole in the envelope.

## True zero clearance

Zero clearance design allows your electric fireplace to be framed into wood or metal studs, providing installation freedom and flexibility for builders, architects, interior designers and homeowners.

## Realistic Natural Flame Solution

A cost-effective alternative to gas or wood fireplaces, EcoSmart's Electric Series emits the same captivating, dancing golden flame - without the messy soot, smoke or ash.

## Flame Colours

Change from orange to blue flame at the touch of a button.

## LED

Use less energy than 100w bulb.

## Toughened Safety Screen

Your Electric Fireplace features toughened glass screen to provide an additional layer of safety and comfort.

## Remote Control Convenience

Easy to operate with fingertip control - each Electric model comes with a sleek remote control that allows you to turn on/off, adjust from a raging fire to ambient backlighting, adjust heat settings and change from orange to blue flame.



## Safe Fire Solution

Cool to touch with heat on or off, it's also a safe option for residential living rooms and commercial spaces like restaurants and hotel foyers.

## Clean/Green

Zero-emission heat source. No gas, no chimney, no venting.

## Power Data Chart

	EL40	EL60	EL80	EL100	EL120
Volts/HZ Amps	AC 120V/60Hz 15 Amps	AC 120V/60Hz 15 Amps	AC 120V/60Hz 15 Amps	AC 120V/60Hz 15 Amps	AC 120V/60Hz 15 Amps
Heater	AC 120V/60Hz 750W/1500W	AC 120V/60Hz 750W/1500W	AC 120V/60Hz 750W/1500W	AC 120V/60Hz 750W/1500W	AC 120V/60Hz 750W/1500W
Lamps	LED 12V	LED 12V	LED 12V	LED 12V	LED 12V
Rotor motor	AC 120V/60Hz 4W CCW 15/18 r/min	AC 120V/60Hz 4W CCW 15/18 r/min	AC 120V/60Hz 4W CCW 15/18 r/min	AC 120V/60Hz 4W CCW 15/18 r/min	AC 120V/60Hz 4W CCW 15/18 r/min



BUILT-IN

# ELECTRIC MODEL SPECS

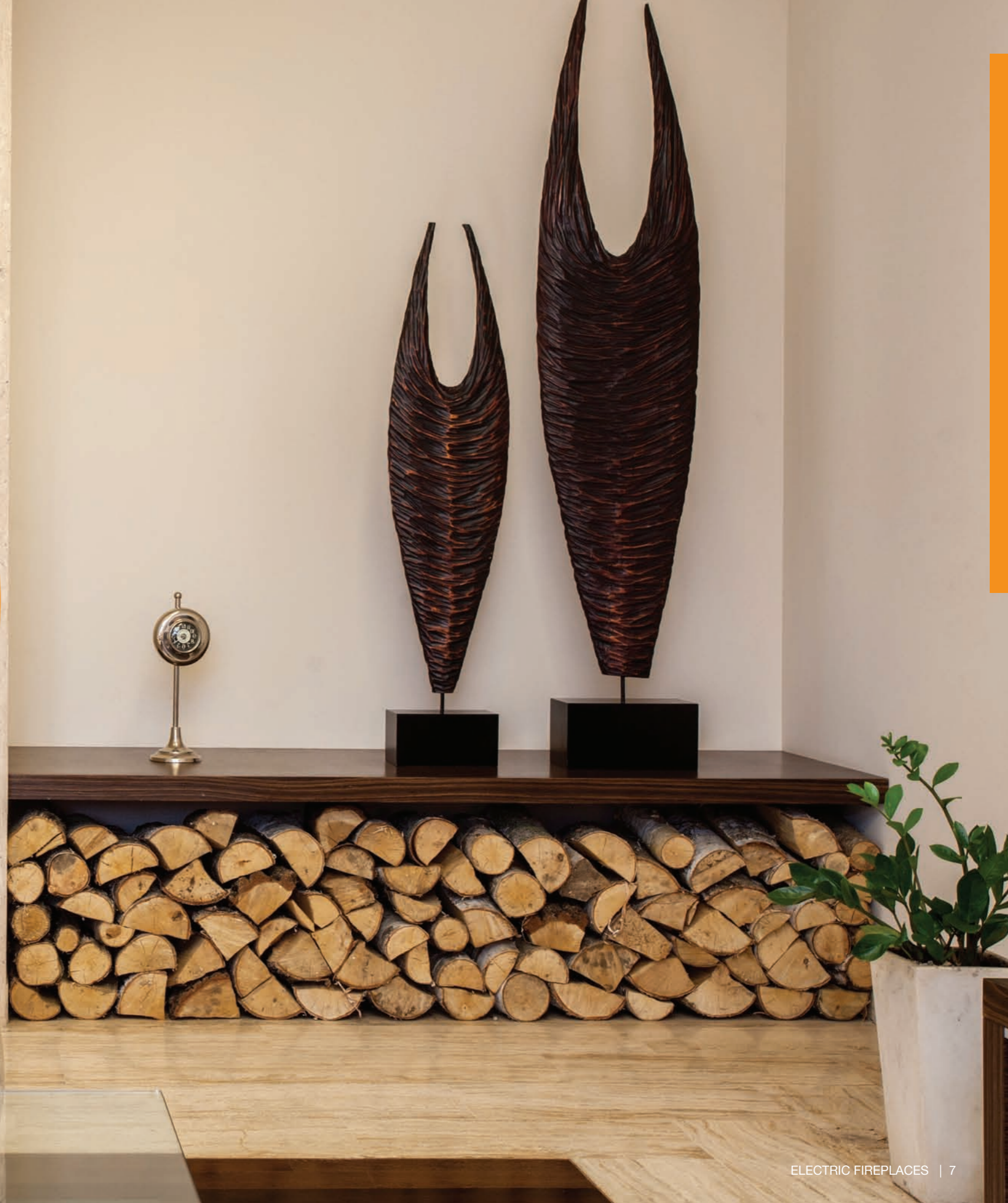



# EL40

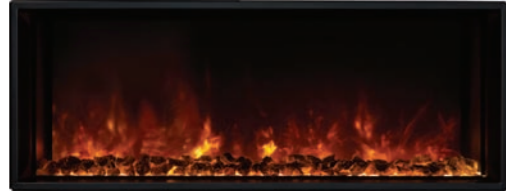

Not available in Australia

<b>Application</b>	Indoor
<b>Materials</b>	Mild Steel with Polymer Satin Power-Coat, Tempered Glass
<b>Weight</b>	44kg [97lbs] (fire unit only)
<b>Colour &amp; SKU</b>	Black ESF.1.EL40

## TECHNICAL SPECIFICATION

<b>Type</b>	Electric
<b>Volts</b>	AC 120V/60Hz
<b>Amps</b>	13.4 Amps
<b>Watts</b>	1530W
<b>Low Heat</b>	750W
<b>High Heat</b>	1500W
<b>No Heater</b>	100W
<b>Lamps</b>	LED
<b>Rotor Motor</b>	AC 120V/60Hz 4W

Read the manual carefully before operating. Physical model dimensions should be verified against cut out dimensions BEFORE installation begins to confirm tolerances align.



Our Electric Fireplaces are ETL Listed.

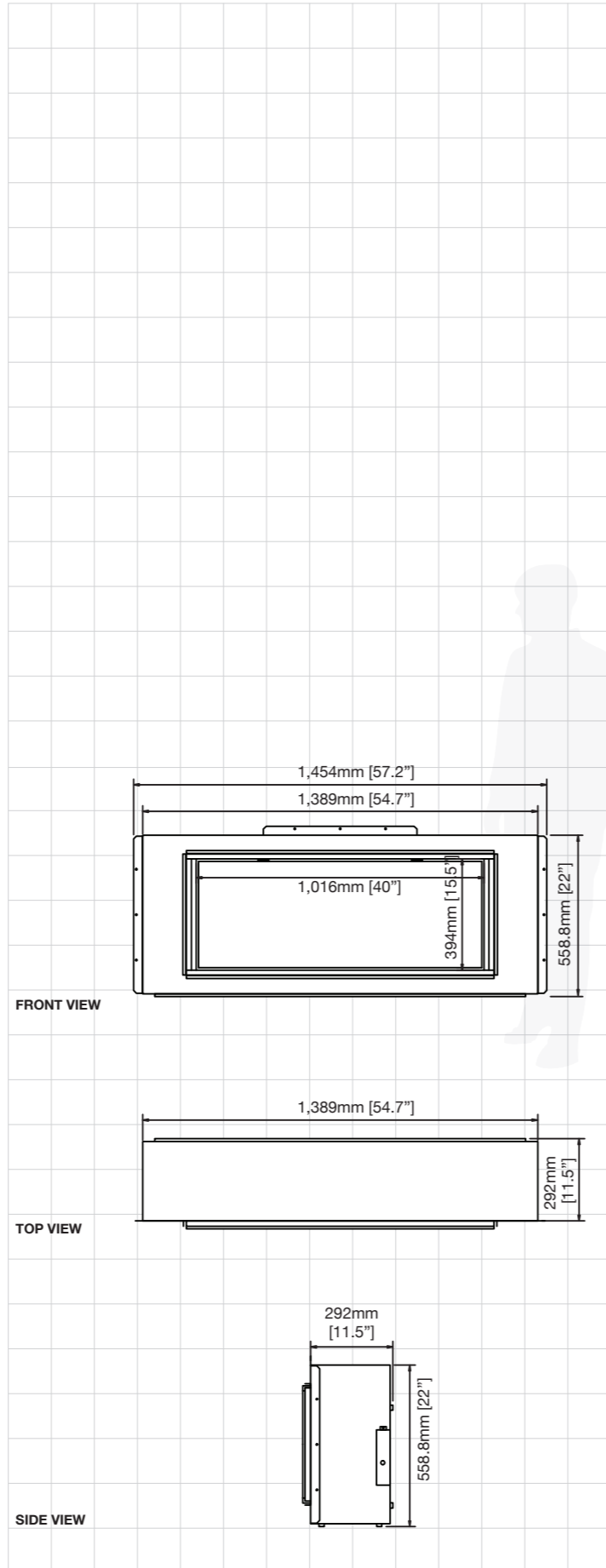

# EL60

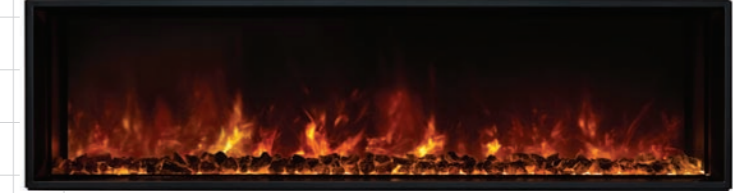

<b>Application</b>	Indoor
<b>Materials</b>	Mild Steel with Polymer Satin Power-Coat, Tempered Glass
<b>Weight</b>	55.6kg [122.5lbs] (fire unit only)
<b>Colour &amp; SKU</b>	Black ESF.1.EL60

## TECHNICAL SPECIFICATION

<b>Type</b>	Electric
<b>Volts</b>	AC 120V/60Hz
<b>Amps</b>	13.4 Amps
<b>Watts</b>	1530W
<b>Low Heat</b>	750W
<b>High Heat</b>	1500W
<b>No Heater</b>	100W
<b>Lamps</b>	LED
<b>Rotor Motor</b>	AC 120V/60Hz 4W

Read the manual carefully before operating. Physical model dimensions should be verified against cut out dimensions BEFORE installation begins to confirm tolerances align.



Our Electric Fireplaces are ETL Listed.

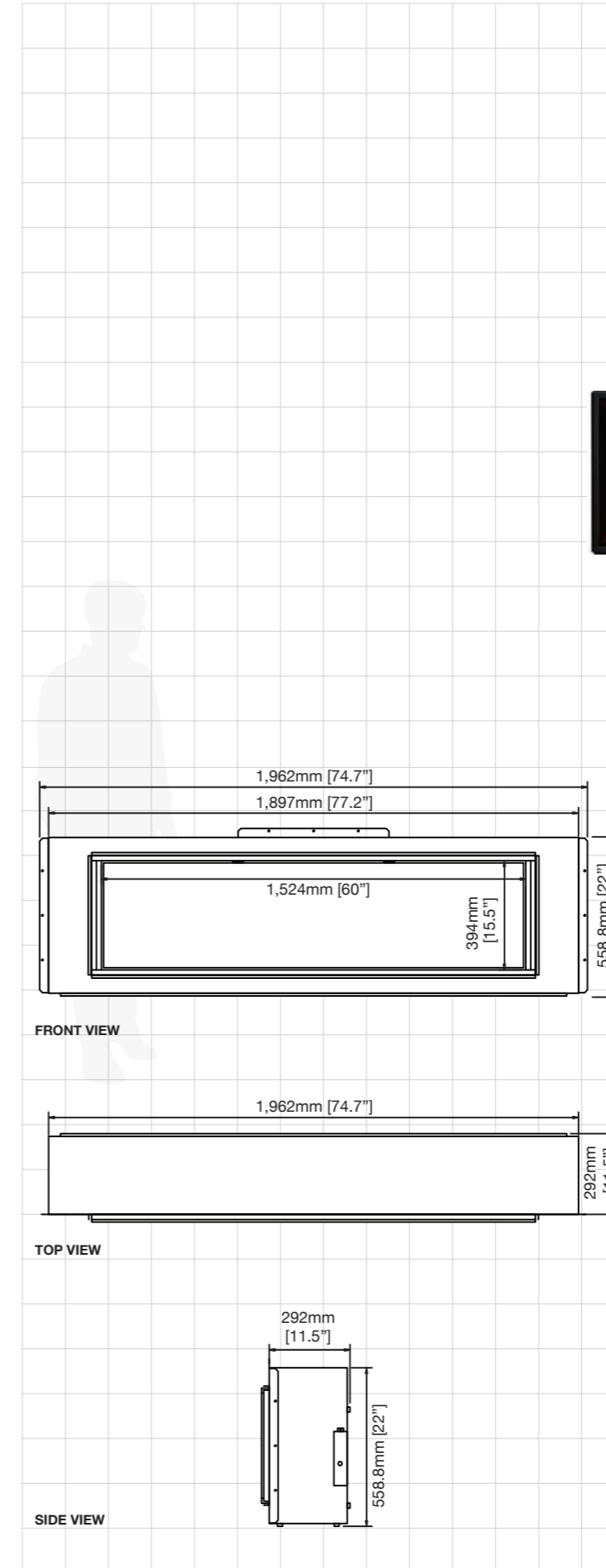

# EL80



Not available in Australia

<b>Application</b>	Indoor
<b>Materials</b>	Mild Steel with Polymer Satin Power-Coat, Tempered Glass
<b>Weight</b>	69.1kg [152.3lbs] (fire unit only)
<b>Colour &amp; SKU</b>	Black ESF.1.EL80

## TECHNICAL SPECIFICATION

<b>Type</b>	Electric
<b>Volts</b>	AC 120V/60Hz
<b>Amps</b>	13.4 Amps
<b>Watts</b>	1530W
<b>Low Heat</b>	750W
<b>High Heat</b>	1500W
<b>No Heater</b>	100W
<b>Lamps</b>	LED
<b>Rotor Motor</b>	AC 120V/60Hz 4W

Read the manual carefully before operating. Physical model dimensions should be verified against cut out dimensions BEFORE installation begins to confirm tolerances align.

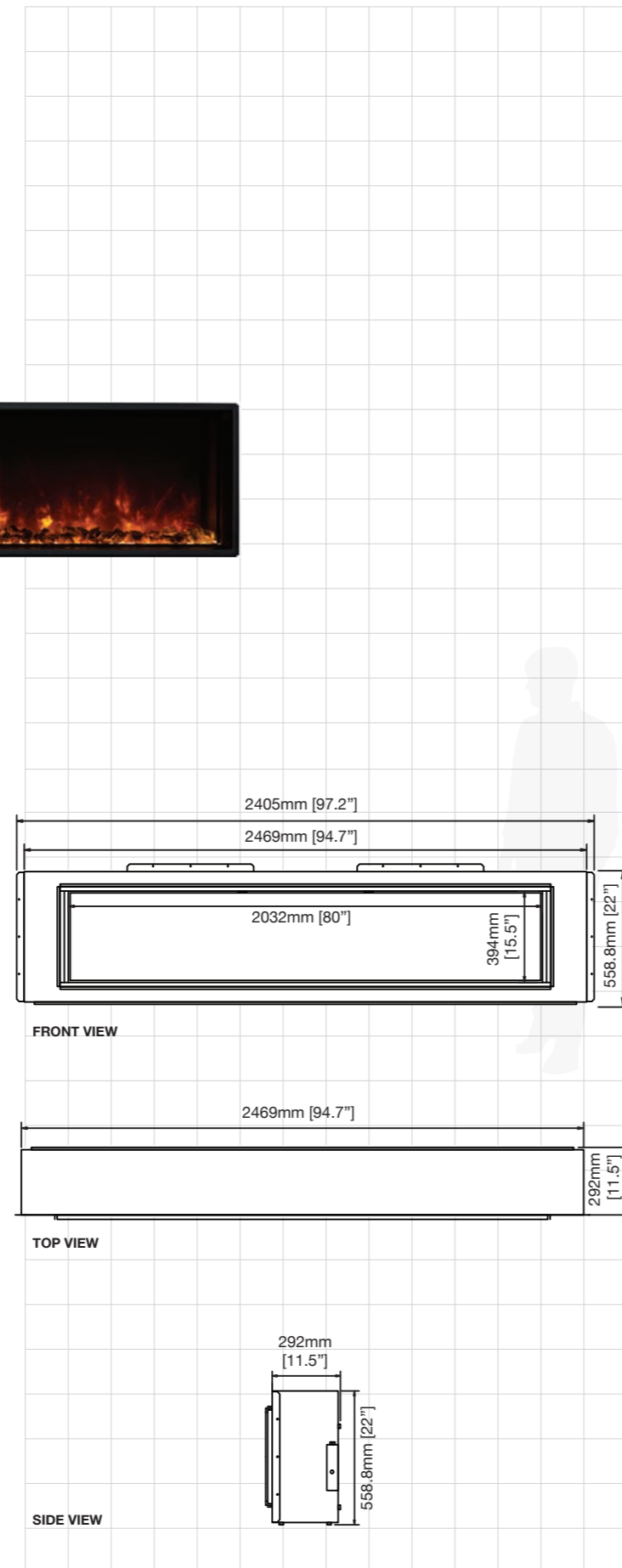

# EL100



<b>Application</b>	Indoor
<b>Materials</b>	Mild Steel with Polymer Satin Power-Coat, Tempered Glass
<b>Weight</b>	88.7kg [195.5lbs] (fire unit only)
<b>Colour &amp; SKU</b>	Black ESF.1.EL100

## TECHNICAL SPECIFICATION

<b>Type</b>	Electric
<b>Volts</b>	AC 120V/60Hz
<b>Amps</b>	13.4 Amps
<b>Watts</b>	1530W
<b>Low Heat</b>	750W
<b>High Heat</b>	1500W
<b>No Heater</b>	100W
<b>Lamps</b>	LED
<b>Rotor Motor</b>	AC 120V/60Hz 4W

Read the manual carefully before operating. Physical model dimensions should be verified against cut out dimensions BEFORE installation begins to confirm tolerances align.

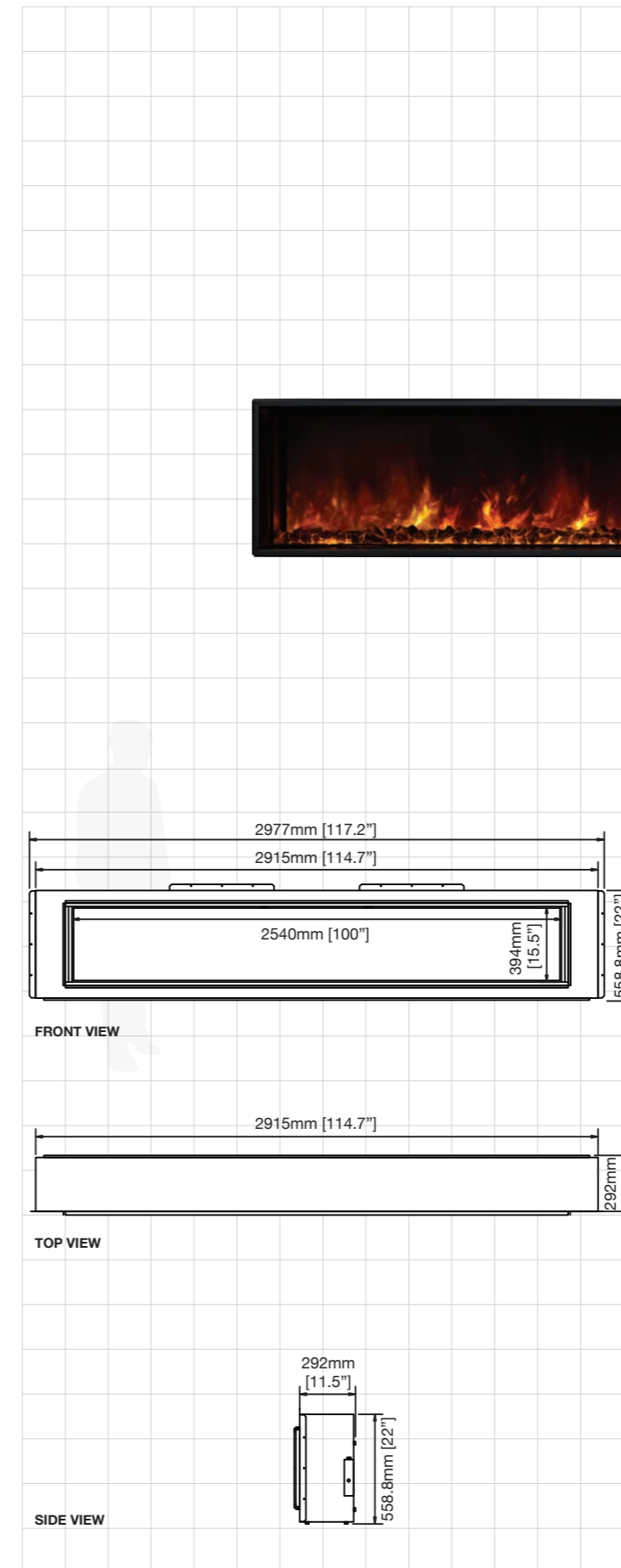

# EL120



Not available in Australia

<b>Application</b>	Indoor	
<b>Materials</b>	Mild Steel with Polymer Satin Power-Coat, Tempered Glass	
<b>Weight</b>	98.9kg [218lbs] (fire unit only)	
<b>Colour &amp; SKU</b>	Black	ESF.1.EL120

## TECHNICAL SPECIFICATION

<b>Type</b>	Electric
<b>Volts</b>	AC 120V/60Hz
<b>Amps</b>	13.4 Amps
<b>Watts</b>	1530W
<b>Low Heat</b>	750W
<b>High Heat</b>	1500W
<b>No Heater</b>	100W
<b>Lamps</b>	LED
<b>Rotor Motor</b>	AC 120V/60Hz 4W

Read the manual carefully before operating. Physical model dimensions should be verified against cut out dimensions BEFORE installation begins to confirm tolerances align.

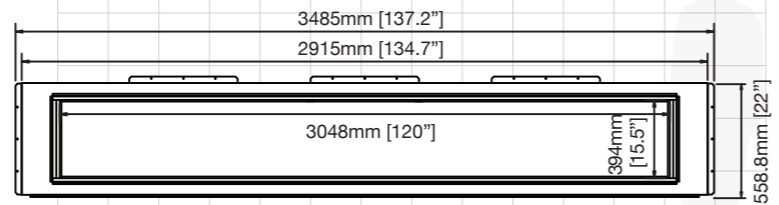

FRONT VIEW

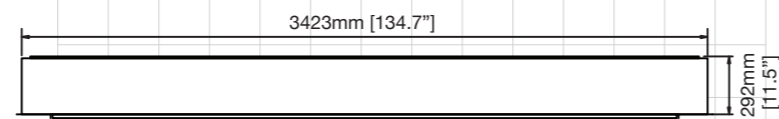

TOP VIEW

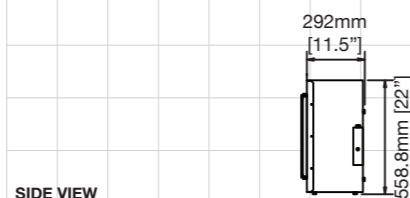

SIDE VIEW

# ELECTRIC FIREPLACE INDICATIVE INSTALL

GUIDE ONLY - MUST READ THE INSTRUCTIONS INCLUDED WITH THE MODEL

1. Prepare the framed opening using wood or metal studs.

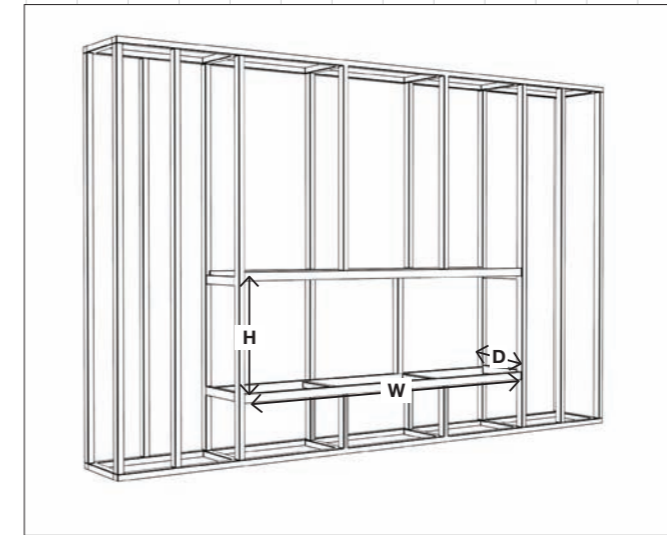

4. Install the fire unit in the framed opening with a minimum 32mm [1.25"] drywall screws to secure the unit.

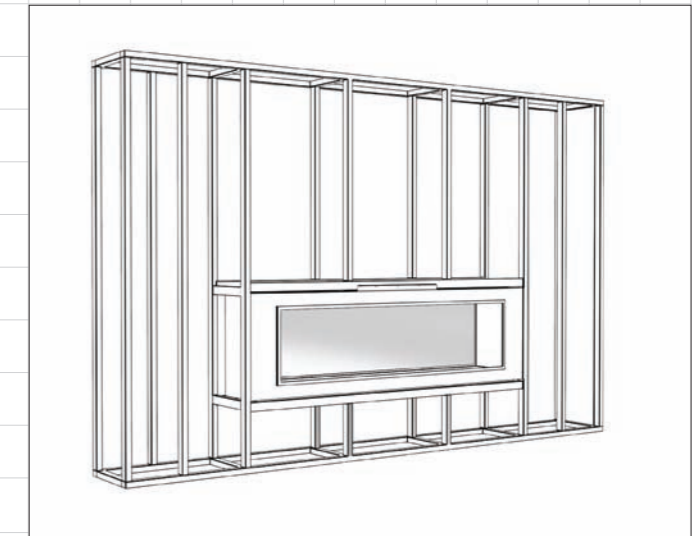

2. Install L shaped metal nailing flanges onto fireplace.

3. Connect hard wire to the terminal block according to the diagram below. Choose any connector type according to local building code.

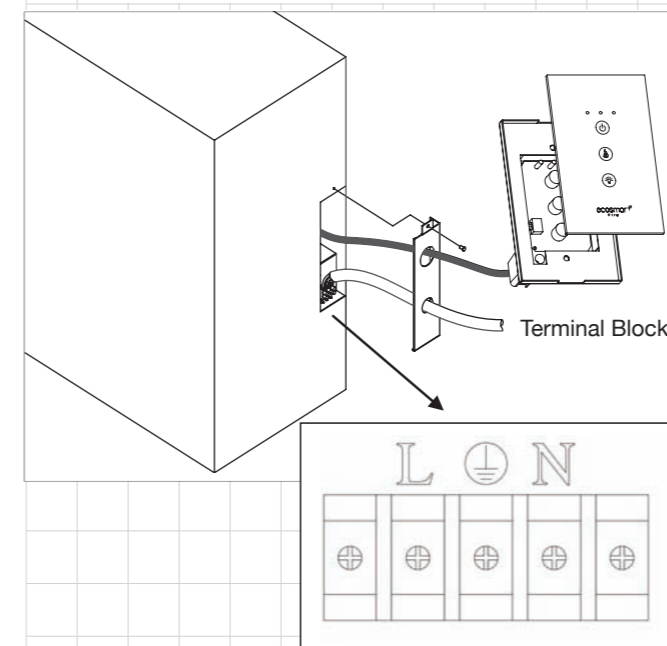

5. Mask the exposed fire unit during the drywall process. Install drywall to the drywall stops on the perimeter of the fire insert.

6. After installation, user may elect to use the L Metal Deco Trim. To install, use a small amount of construction adhesive and secure to the drywall face.

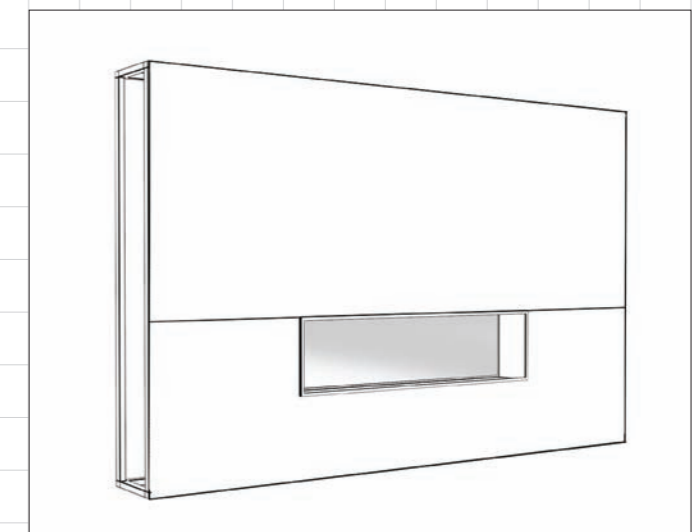









For more information

**EcoSmart Inc.**  
5875 Green Valley Circle, Suite 100  
Culver City, CA 90230  
[ecosmartfire.com](http://ecosmartfire.com)

Reproduction of this catalogue in any manner, in any language, in whole or in part without prior written permission is prohibited. The Fire Company Pty Ltd reserves the right to correct any errors or misprints. All product specifications and data are subject to change without notice and believed to be correct at the time of publication. The Fire Company Pty Ltd, its affiliates, agents, and employees, and all persons acting on its or their behalf (collectively, "The Fire Company"), disclaim any and all liability for any errors, inaccuracies or incompleteness contained herein or in any other disclosure relating to any product. The Fire Company disclaims any and all liability arising out of the use or application of any product described herein or of any information provided herein to the maximum extent permitted by law. The product specifications do not expand or otherwise modify The Fire Company P/L's terms and conditions of purchase, including but not limited to the warranty expressed therein, which apply to these products. No license, express or implied, by estoppel or otherwise, to any intellectual property rights is granted by this document or by any conduct of The Fire Company. Customers using or selling The Fire Company products not expressly indicated for use in such applications do so entirely at their own risk and agree to fully indemnify The Fire Company for any damages arising or resulting from such use or sale. Please contact authorised personnel from The Fire Company to obtain written terms and conditions regarding products designed for such applications. International Patent Pending - Trademarks Pending - All Designs Registered. V1017



ECO  
SMART  
FIRE  
.COM