



Wilmington™
Gas-Burning Fireplace



KINDRED

OUTDOORS + SURROUNDS



INTRODUCTION	3
SAFETY WARNINGS	4
GENERAL INFORMATION	5
PRODUCT USAGE	5
MODIFICATION OF FIREPLACE	5
VENTILATION	5
COMBUSTIBLE CLEARANCES	5
DAMAGED PARTS	5
MAINTENANCE	5
DIMENSIONS	6
PARTS LIST	7
INSTALLATION RECOMMENDATIONS	8
FIREPLACE INSTALLATION STEPS	8
FINISHING FIREPLACE EXTERIOR	11
3-YEAR LIMITED WARRANTY	12

Fireplace systems are designed for installation in accordance with the National Fire Protection Association Standard for Chimneys, Fireplaces, Vents and Solid Fuel-Burning Appliances (NFPA 211).



Since its discovery, fire has become much more than an essential element in our lives—it can set the mood in any environment. Now you can command the element of fire to enjoy its comfort and ambiance among family and friends. The Wilmington Fireplace features architectural touches such as an arched opening and cantilevered mantel for an elegant design. Delivered complete with a scratch-coat surface, the Wilmington can be finished for an impressive custom masonry appearance. It's time to rediscover fire.

Image: **Wilmington** fireplace shown installed using extensions and finished with a natural stone veneer.



SAFETY WARNINGS

WARNING

Before beginning installation of the Wilmington Fireplace, read these instructions carefully to be sure you understand them completely. Failure to follow them could cause fireplace malfunction resulting in serious injury or property damage.

Obtain necessary permits from authorities in your local jurisdiction and comply with all local building codes.

To avoid the risk of damaging fireplace materials and increasing risk of spreading fire, do not use the fireplace to cook or warm foods.

This unit has not been tested for use with doors. To reduce the risk of injury, do not install doors.

This product has not been tested for use with a chase. To reduce the risk of fire, do not install a chase.

Do not pack air spaces with insulation or other materials.

Before servicing, allow the fireplace to cool. Always shut off any electricity or gas to the fireplace while working on it.

Never use gasoline, kerosene, gasoline-type lantern fuel, charcoal lighter fluid, or similar liquids in this fireplace. Keep all flammable liquids at a safe distance from the fireplace.

Gas log sets used with this product must be approved for outdoor use.

Have a licensed plumber install your gas lines.

CAUTION

This unit(s) is designed to only burn gas log sets outdoors. Do not attempt to burn any paper, cardboard, tree branches/yard waste, fuel (such as charcoal) or building construction materials in this fireplace. The intense fires these products create may overheat the fireplace thus causing damage to the unit or a potential fire outside the firebox.

DO NOT DRAG OR SLIDE FIREPLACE SECTIONS – dolly or hand carry all fireplace components.



GENERAL INFORMATION

PRODUCT USAGE

The Wilmington Fireplace is designed to burn gas log sets outdoors. This unit is not designed to sit directly against combustible materials. This unit is not designed to be built into a wood structure. The Wilmington Fireplace is designed as an outdoor unit only. As required due to heat and weight, this unit must be built on a non-combustible concrete slab (code-compliant frost-free footer) designed to carry the total weight of the entire fireplace and chimney structure along with finished veneer.

BTU gas set used with this product must be approved for outdoor use.

MODIFICATION OF FIREPLACE

Modifications to the Wilmington Fireplace are prohibited. Any modifications may void claims, listings and approvals and could result in an unsafe and potentially dangerous installation.

The installer indemnifies the manufacturer of all claims and under no circumstances will manufacturer be liable for consequential, incidental, indirect, punitive or other damages of any kind or nature, whether foreseeable or not, based on any claim by any party as to the modifications of the fireplaces.

VENTILATION

The Wilmington Fireplace is designed as an outdoor unit only. No additional ventilation or circulation is required.

COMBUSTIBLE CLEARANCES

The distances to combustibles while burning solid wood shall be no less than 60" from the front of firebox, 12" from the side walls and 4" from the back wall. When a vented or ventless gas log set is used and the top of the chimney capped, the clearances shall be no less than 16" from the front, 4" from the back and 1" from the top of the chimney.

DAMAGED PARTS

If unit is delivered with obvious damage due to freight, please notify driver or refuse delivery. If product is damaged on job site, you may be able to repair unit using adhesive and/or mortar. If damage is severe, contact your dealer to arrange shipment of replacement parts.

MAINTENANCE

Please contact a professional chimney sweep at least once each year to inspect and make recommendations regarding the maintenance of your outdoor fireplace. In the event you have added a decorative chimney termination or rain cap to your fireplace, please be prepared to inform the chimney sweep as to the best method to perform proper inspection/maintenance.



DIMENSIONS

FIREPLACE

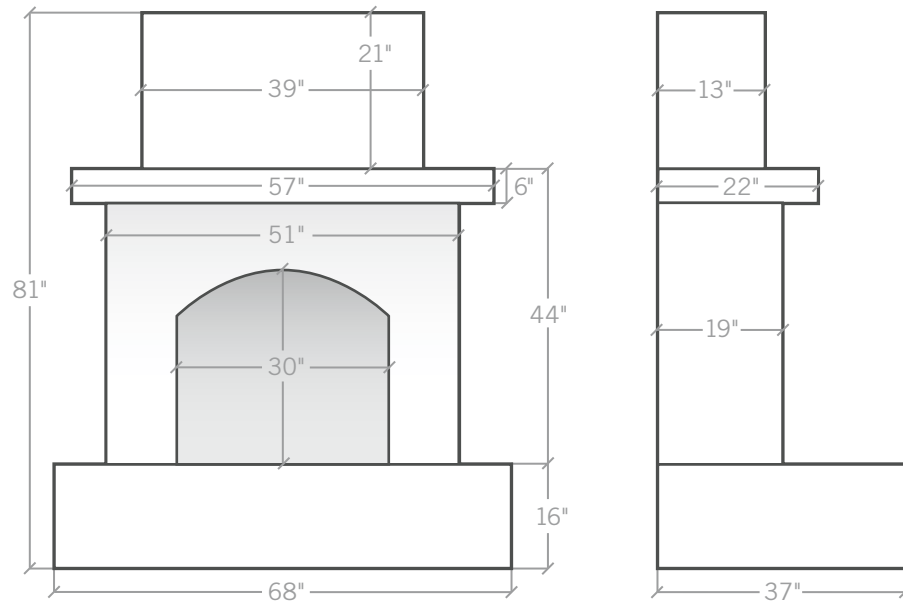

FIREPLACE WITH OPTIONAL EXTENSIONS

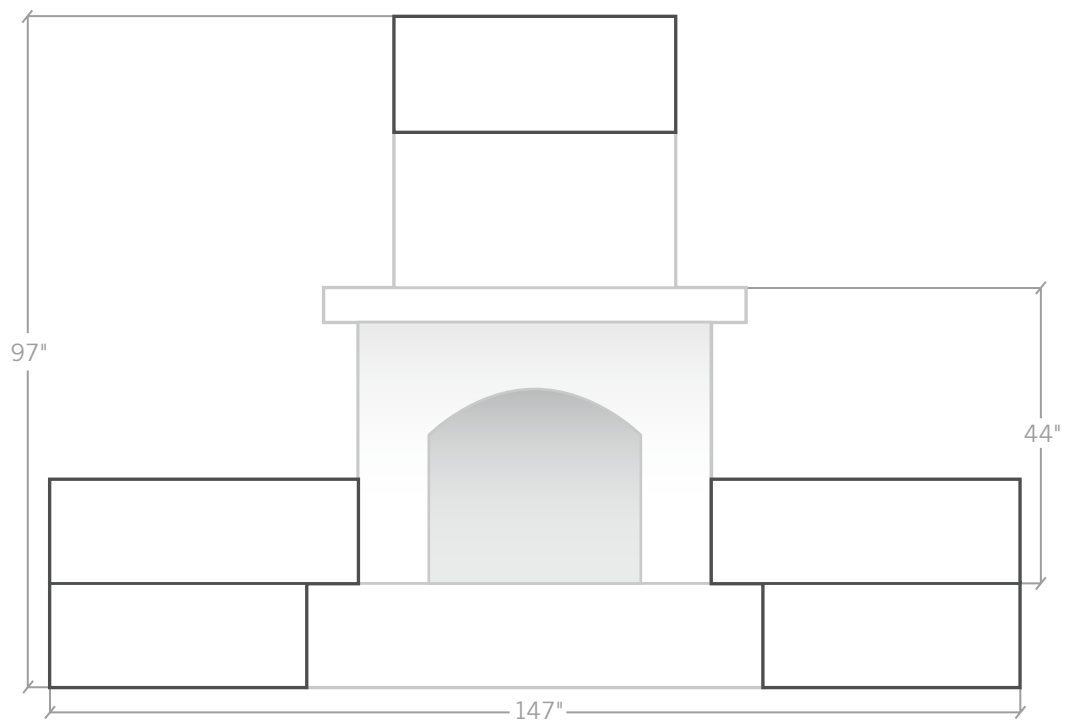



PARTS LIST

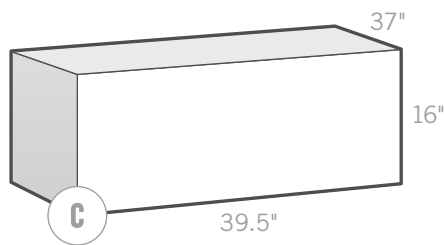
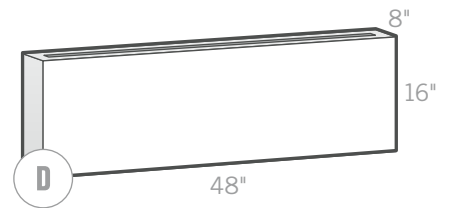
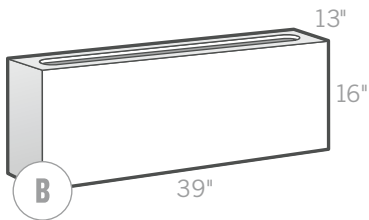
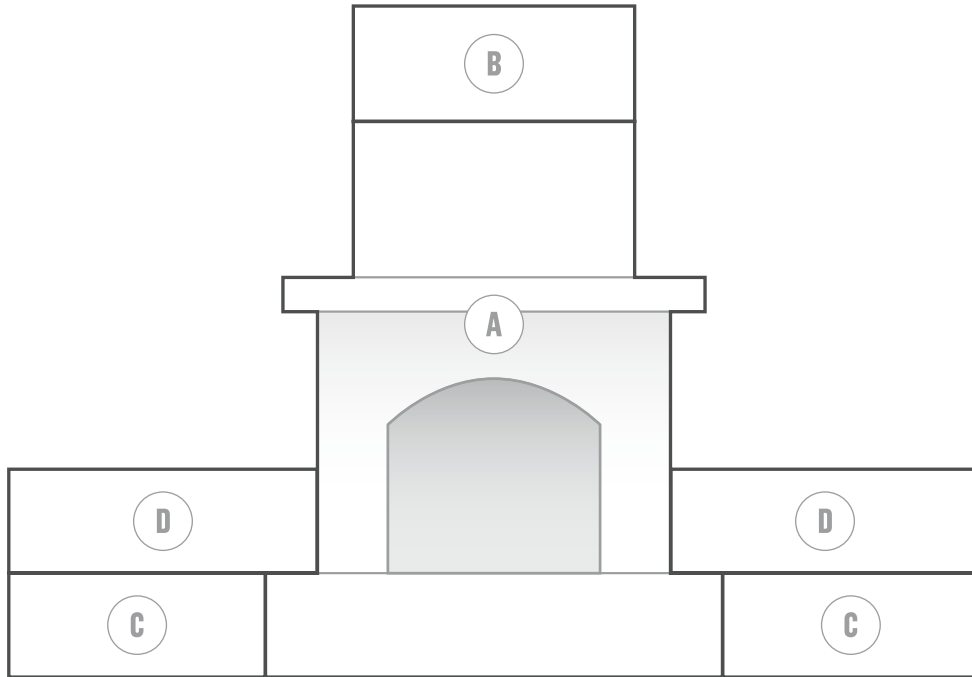

ITEM	PART	QTY.
A	Gas-Burning Fireplace	1
B	Optional Gas-Burning Fireplace Chimney Extension	1
C	Optional Gas-Burning Fireplace Hearth Extension	2
D	Optional Gas-Burning Fireplace Hearth Extension Backrest	2



INSTALLATION RECOMMENDATIONS

A minimum of 2 people are required to install the Wilmington fireplace with a recommendation of 4 people if available. The following tools will make your installation a smooth process and give the best results:

2 qty. 3/4" Box Wrenches or Sockets

Razor Knife

FIREPLACE INSTALLATION STEPS

1

UNPACKING

- a) Begin by identifying the 3 interior "fire box" panels. Panels will be wrapped to one side of the entire package. Use a razor knife to cut away packing material and place panels in a safe place for later installation.

CAUTION: Packing material may be used to hold panels in place. Careless removal of packing material may result in damaged panels.

TIP: Remove one panel at a time while a second person holds remaining panels in place.

- b) Remove the "chimney" section which is packaged on top.
- c) With one person on each side, lift section 6 inches then remove and set aside for later installation.
- d) Move the base of the fireplace out 3-4 inches away from the center section.

CAUTION: A fourth interior panel is located in a fold of cardboard between the fireplace base and the center section. Locate and remove this panel immediately and set aside to prevent damage.





FIREPLACE INSTALLATION STEPS Continued

2 FIREPLACE BASE & CENTER SECTION INSTALLATION

Fireplace must be placed on solid flat surface, concrete slab, pavers or stone deck. **NOTE:** The rear of the fireplace must be placed a minimum of 6 inches away from combustible materials. **DO NOT** place combustible materials within 3 feet of firebox opening. **DO NOT** place fireplace under overhead combustible areas.

a) Position base of fireplace in desired location.

CAUTION: Carefully lift and remove all fireplace sections. Handle each section from its base or from structurally sound locations. It is highly recommended that you utilize packing material such as wrapping and cardboard to protect product during transport. Do not allow products to directly touch hard surfaces such as concrete, dollies, or fireplace sections until product is in its final position.

b) With one person on each side, position center section of fireplace on top of base section.

c) The center section is in its correct position when all bolt holes line up inside the fireplace.

CAUTION: Lift and rest center section to align bolt holes. **DO NOT** slide center section on top of base section as damage will occur.

d) Bolt the center section to the base section with provided hardware.





FIREPLACE INSTALLATION STEPS Continued

3 FIREPLACE INTERIOR PANEL INSTALLATION

- a) Install firebox floor panel through fireplace opening.
- b) Install firebox rear panel from the top. **NOTE:** The large row of “bricks” on the rear panel must be placed on the bottom.
- c) Temporarily place rear panel as far to the rear of the firebox as possible. Do not place in groove at this time.
- d) While a second person holds the rear panel in place. Install both side sections inside the grooves located in the bottom section. **NOTE:** The large row of “bricks” on the side panels must be placed on the bottom.
- e) Insert back panel into groove.
- f) Adjust all panels until they align properly.
- g) Insert provided panel wedges between the top of the rear panel and the fireplace wall to secure panels.

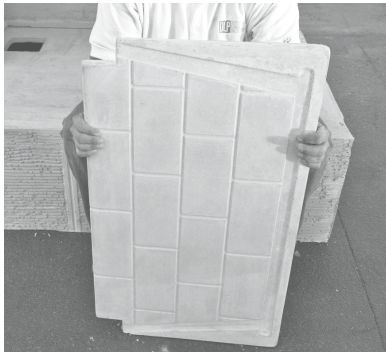



FIREPLACE INSTALLATION STEPS Continued

4 FIREPLACE TOP “CHIMNEY” INSTALLATION

DO NOT place fireplace under overhead combustible areas

- a) With a minimum of one person on each side, carefully lift top section to waist level.
- b) Once in front of fireplace, place your leg which is closest to the fireplace on the base section and rest the fireplace top temporarily on your leg.

CAUTION: The fireplace top is very awkward and heavy! It is recommended that four people are involved in this step to prevent injury and damage.

- c) With the top section on your leg, adjust your grip to allow you to lift the top section to chin level.
- d) Evenly lift top section and position over center section, then, slowly lower into position.

CAUTION: The fireplace top must be lowered over the center section slowly and evenly from both sides. If one side is lowered too fast or at an awkward position, severe damage may occur.

**Gas log sets used with this product must be approved.
Have a licensed plumber install your gas lines.*



FINISHING FIREPLACE EXTERIOR

Customize your Wilmington Gas-Burning Fireplace by dressing it with an application of stone, brick, natural veneer or stucco.

Enhance the aesthetic and tactile appeal of your next project with the natural textures and authentic color palettes of high-performance architectural stone veneer.



3-YEAR LIMITED WARRANTY

1. Subject to the following terms, WestlakeRoyal LLC. ("Westlake") warrants to the original purchaser and subsequent owners that for 36 months from the date of sale, its Kindred Outdoor product will perform according to its specifications. This Limited Warranty is not limited to the original purchaser but covers the stone regardless of whether ownership of the building changes. This warranty runs with the transfer of the property to subsequent owners of the property into which the warranted products have been incorporated.
2. This Limited Warranty is not limited to the original purchaser but covers Kindred Outdoor regardless of whether ownership of the premises changes. This warranty runs with the transfer of the property to subsequent owners of the property into which the warranted products have been incorporated, but the warranty period as to such subsequent owners is limited to six (6) months or the remaining life of the 36 month original purchaser warranty from the original date of installation, whichever is longer.
3. Subject to the terms hereof, Westlake warrants Kindred Outdoor to the Purchaser and subsequent owners for a period of THIRTY-SIX (36) MONTHS from the date of sale. In the event that a Kindred Outdoor product is defective, Westlake will, as its sole discretion, either: a) provide a replacement of the defective product or pay the reasonable cost for replacement product of a similar design; or b) pay the reasonable cost for repair of the defective product. THIS WARRANTY DOES NOT COVER LABOR TO REMOVE OR REPLACE THE DEFECTIVE PRODUCT.
4. No warranty whatsoever is made with respect to the manufacture or performance of materials or components of construction not sold or manufactured by Westlake, including but not limited to all installation components including but not limited to, mortar, lath, weather resistant barriers, doors, windows, sealants, flashings, roofing, copings, sheathing and framing. Further, Westlake makes no warranties whatsoever with respect to aesthetics, design and engineering of the structure into which Westlake products are incorporated, or workmanship involved in the application of any Westlake products warranted hereunder. The Westlake product is not waterproof. The Westlake product must be incorporated into a cladding designed by a building professional that contains adequate mechanisms for water management. Westlake has no responsibility for damage caused by moisture intrusion through the building envelope or around any of the building envelope components or by vapor transmission from the inside of the building to a moisture sensitive part of the wall assembly.
5. Without limiting anything else in this document, Westlake disclaims and assumes no liability for:
 - 5.1 improper use, application or installation of Westlake products,
 - 5.2 use of Westlake products as part of improperly designed or constructed assemblies or buildings or with defective adjacent materials or assemblies;
 - 5.3 failure to follow applicable specifications, instructions and construction details;
 - 5.4 other design or construction defects, deficiencies and failures on a building where Westlake product is used;
 - 5.5 undertaking on-site inspections or any on-site activities or making oral statements made at the site;
 - 5.6 ~~pay damage of Kindred Outdoor~~ damage of Kindred Outdoor caused or physical abuse such as but not limited to falling objects, projectiles, fire, earthquake, floods, windstorm, hail, tornadoes, lightning, hurricanes, other abnormal weather conditions, pests, chemical fumes, foreign substances in the air, misuse, vandalism, civil disobedience, war, damage caused by remodeling or renovation;
 - 5.7 damage resulting from moisture intrusion, mold, settlement of building or other building or wall movement;
 - 5.8 discoloration or deterioration due to airborne contaminates; or contact with any chemicals or paint; staining or oxidations;
 - 5.9 any accumulation of water or moisture in wall assemblies;
 - 5.10 negligence or accidents by any party or parties in maintaining the Westlake materials including but not limited to use of pressure washer to clean;
 - 5.11 replacement of Kindred Outdoor if Westlake's product is mixed with other chemicals or materials not approved by Westlake in writing;
 - 5.12 any cause beyond Westlake's control; and
 - 5.13 ~~any sole and ship, city, the ised by other and a nge in idirect~~ any sole and ship, city, the ised by other and a nge in idirect in Westlake's products as covered under this warranty.



3-YEAR LIMITED WARRANTY Continued

6. THIS LIMITED EXPRESS WARRANTY IS EXCLUSIVE, THE ONLY WARRANTY MADE BY WESTLAKE, AND IS IN LIEU OF ALL OTHER WARRANTIES OR REMEDIES OF ANY NATURE WHATSOEVER TO THE ORIGINAL OR SUBSEQUENT PURCHASERS OR USERS UNDER ANY THEORY OF LIABILITY, WHETHER IN CONTRACT, TORT, STATUTORY LAW OR OTHERWISE, EXCEPT FOR ACTUAL ECONOMIC DAMAGES FOR PERSONAL PHYSICAL BODILY INJURY. ALL OTHER WARRANTIES, REPRESENTATIONS OR REMEDIES, WHETHER ORAL, WRITTEN, EXPRESS OR IMPLIED OR IMPOSED BY LAW ARE DISCLAIMED BY WESTLAKE AND ARE WAIVED BY THE PURCHASER, PARTICULARLY THE IMPLIED WARRANTIES OF MERCHANTABILITY OR FITNESS FOR A PARTICULAR PURPOSE OR ARISING FROM A COURSE OF DEALING, USAGE OR TRADE PRACTICE, OR ANY WARRANTY AGAINST PATENT INFRINGEMENT OR WARRANTY FOR WORK PERFORMED IN A WORKMANLIKE MANNER. WESTLAKE SHALL NOT BE LIABLE UNDER ANY CIRCUMSTANCES FOR ANY INCIDENTAL, SPECIAL, INDIRECT OR PUNITIVE DAMAGES TO ANY PARTY WHATSOEVER, INCLUDING BUT NOT LIMITED TO, LOSS OF PROFITS OR DAMAGE TO THE BUILDING OR ITS CONTENTS, ATTORNEY'S FEES. THIS EXCLUSION OF DAMAGES INCLUDES, BUT IS NOT LIMITED TO PAYMENTS OF ANY NATURE MADE BECAUSE OF ACTUAL OR POTENTIAL LIABILITY TO OTHERS, DAMAGES TO ANY OTHER PART OF THE STRUCTURE TO WHICH THE WARRANTED PRODUCTS ARE INCORPORATED OR DAMAGE TO ANY OTHER PROPERTY.
7. Any complaints regarding appearance or cosmetic effect, including but not limited to color, tint, hue, shading, grain, texture, finish, color consistency, chipping, staining, or non-structural cracks of products must be conveyed in writing to Westlake by the Purchaser prior to commencing installation. Upon receipt of a written complaint, Westlake will examine its production records and compare them with approved samples and in the event of a manufacturing discrepancy, will provide a remedy in accordance with the provisions of this Warranty. Westlake shall have a minimum period of sixty (60) days to investigate any complaint.
8. This limited warranty is exclusive and is in lieu of all other warranties or remedies at law or in equity. All other warranties, representations, or remedies, whether oral, written, express, implied, or imposed by law are disclaimed by Westlake and waived by the Purchaser and any subsequent owner. Westlake expressly disclaims any warranty of merchantability or fitness for a particular purpose, or any warranties arising from a course of dealing, usage or trade practice, or any warranty against patent infringement or warranty for work performed in a workmanlike manner. Oral statements by Westlake employees or agents do not constitute warranties, shall not be relied upon by the Purchaser or any third party, and are not part of the contract for sale or warranty stated herein. Westlake SHALL NOT BE LIABLE FOR ANY INCIDENTAL, SPECIAL, CONSEQUENTIAL, OR PUNITIVE DAMAGES, INCLUDING BUT NOT LIMITED TO LOSS OF PROFITS OR ATTORNEYS' FEES.
9. This Warranty shall be construed and interpreted under the laws of New York. Any provision of this warranty that is prohibited or unenforceable in any jurisdiction shall, as to that jurisdiction only, be ineffective to the extent of such prohibition or unenforceability without invalidating the remaining provisions hereof or affecting the validity of enforceability of such provision in any other jurisdiction. Any applicability of the Magnusson-Moss Act is hereby disclaimed. Westlake's failure at any time to enforce any of the terms or conditions stated herein shall not be construed to be a waiver of such provisions.



KINDRED

OUTDOORS + SURROUNDS