

# VRE4200 36/42

## INDOOR AND OUTDOOR VENT-FREE FIREBOX

Framing Dimensions

Opening	VRE4236	VRE4242
A	42-3/4" (1086)	48-3/4" (1238)
B	46-1/2" (1181)	46-1/2" (1181)
C	23-5/8" (600)	29-5/8" (753)
D	11-1/4" (286)	14-1/4" (362)
E	63-1/2" (1613)	69-1/2" (1765)
F	31-3/4" (807)	34-3/4" (883)
G	20-1/2" (521)	20-1/2" (521)
H	44-1/4" (1124)	49-1/8" (1248)

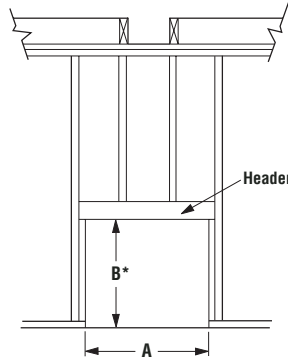

\* Increase Framing Height By 3/4" When Using Optional Drain Pan

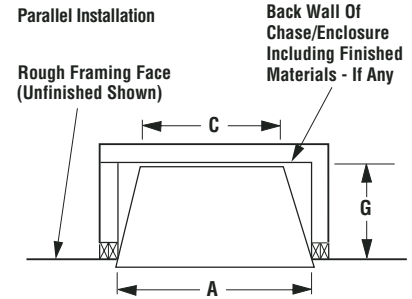
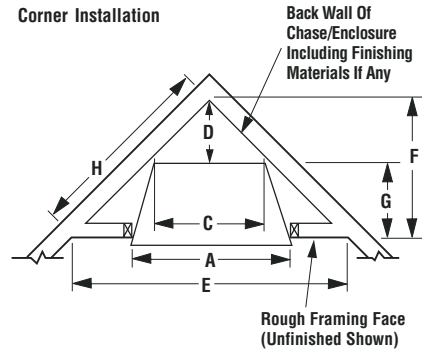

Listing Information

These appliances comply with National Safety Standards and are tested by PFS Corporation (Report No. F14-168) and listed by ANSI Z21.91 (2017) as Ventless Firebox Enclosures.

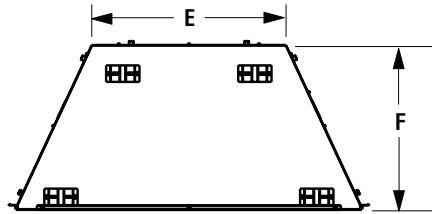
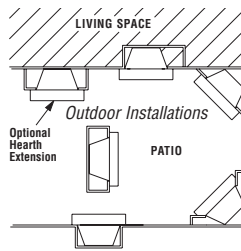

Top View

Interior Firebox Dimensions**		
Firebox Model	36"	42"
Front Width	35 (889)	41 (1042)
Rear Width	23-1/4 (591)	29-1/4 (743)
Depth	17-3/8 (441)	17-3/8 (441)
Height	28 (711)	28 (711)

\*\*Dimensions are to assist you in selecting a log set that is a compatible size.

Fireplace Specifications

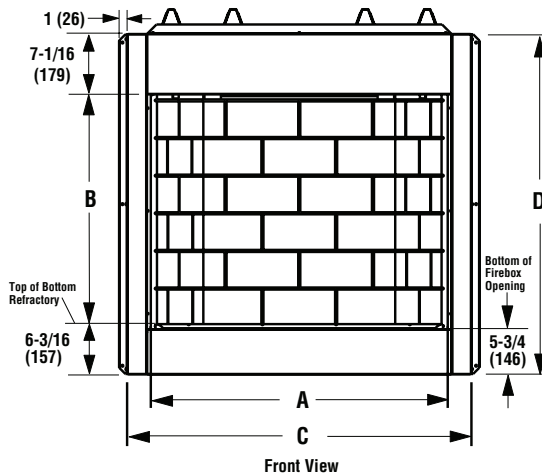

Front View

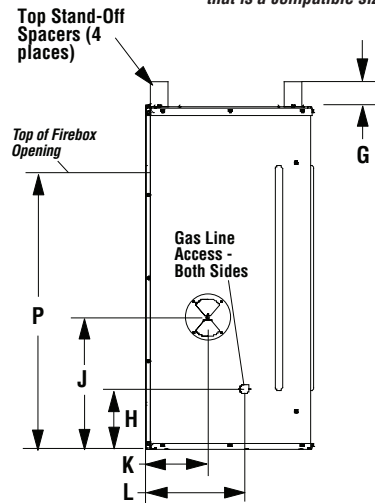

Right Side View

Inches (millimeters)

Model No.	Dimensions - Inches (millimeters)														
	A	B	C	D	E	F	G	H	J	K	L	M	N	P	
VRE4236	36 (914)	28 (711)	41-3/4 (1061)	41-1/4 (1048)	23-1/2 (597)	20 (508)	3 (76)	8-3/8 (213)	15-7/8 (403)	7-1/2 (190)	12 (305)	1-3/8 (35)	5-1/2 (140)	34-3/8 (873)	
VRE4242	42 (1067)	28 (711)	47-3/4 (1213)	41-1/4 (1048)	29-1/2 (749)	20 (508)	3 (76)	8-3/8 (213)	15-7/8 (403)	7-1/2 (190)	12 (305)	1-3/8 (35)	5-1/2 (140)	34-3/8 (873)	

# VRE4200 36/42

Cat. #	Model	Description	Ship Wt.	Ship. Vol.
F4106	VRE4236WS	OD VF Firebox, 36", White Stack	215 lb.s	28.424 Cu. Ft.
F4107	VRE4236WH	OD VF Firebox, 36", White Herr.	215 lb.s	28.424 Cu. Ft.
F4108	VRE4242WS	OD VF Firebox, 42", White Stack	245 lb.s	32.184 Cu. Ft.
F4109	VRE4242WH	OD VF Firebox, 42", White Herr.	245 lb.s	32.184 Cu. Ft.

Typical Installation

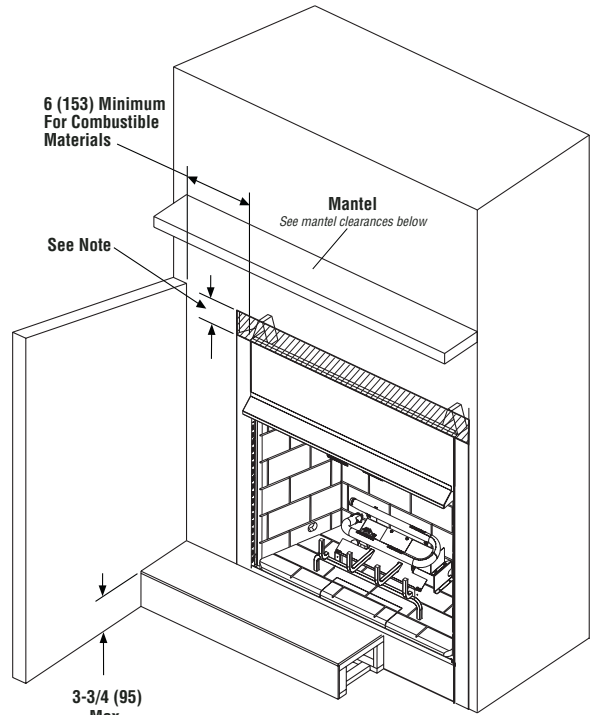
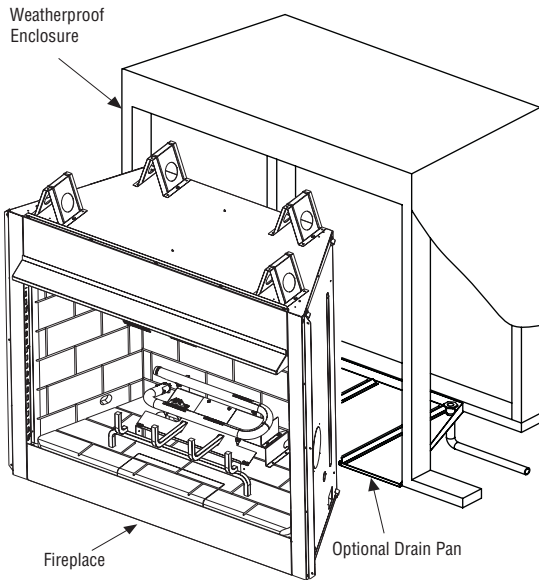

**NOTE:** The area above the face to the top of the spacers must be non-combustible materials.

## Mantel Clearances

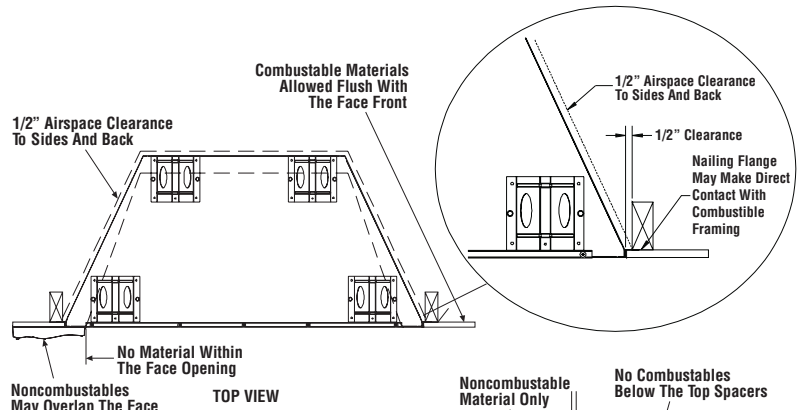
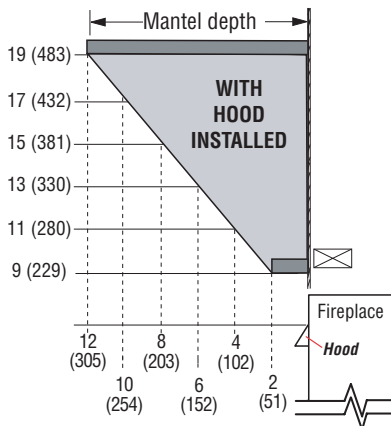

Clearances

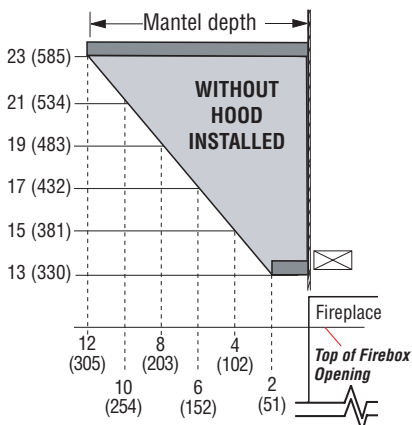

## CLEARANCES

Minimum clearance to combustibles for the fireplace is as follows; sides and back – 1/2" (13mm), combustible floor – 0" (0mm), adjacent wall 6" (152mm), ceiling – 50" (1270mm).

**NOTE:** Clearance behind the nailing flange for both fireplace models is 1/2" (13mm).

**NOTE:** Adjacent wall considerations are for an adjacent wall to only a single side. Walls should not be placed at the minimum distance on both sides of the fireplace. Allow at least 4 feet on one side of the fireplace.

inches (millimeters)

