

ELECTRONIC IGNITION OUTDOOR FIREPLACE INSERT



DBOF28EI



LBOF28EI

EI Series

Hi/Lo Models

Installation & Operation Instructions



FIRE INSPIRED[®]

Hearth Products Controls

Fire-inspired since 1975.

660-EI ON/OFF





This is a Safety Alert Symbol

When you see this symbol on the EI Control Panel, or in this manual, look for one of the following signal word panels alerting you to the potential for personal injury, death or major property damage.



WARNING: For Outdoor Use Only.

Installation and service must be performed by a qualified installer, service agency, or the gas supplier.



WARNING

Do not store or use gasoline or other flammable vapors and liquids in vicinity of this or any other appliance.

An LP-cylinder not connected for use shall not be stored in the vicinity of this or any other appliance.



DANGER

FIRE OR EXPLOSION HAZARD

If you smell gas:

- **Shut off gas to the appliance.**
- **Extinguish an open flame.**
- **If odor continues, leave the area immediately.**
- **After leaving the area, call your gas supplier or fire department.**

Failure to follow these instructions could result in fire or explosion, which could cause property damage, personal injury, or death.



DANGER

CARBON MONOXIDE HAZARD



This appliance can produce carbon monoxide which has no odor.

Using it in an enclosed space can kill you.

Never use this appliance in an enclosed space such as a camper, tent, car or home.

INSTALLER: Leave this manual with the appliance.

CONSUMER: Retain this manual for future reference.



WARNING: If the information in this manual is not followed exactly, a fire or explosion may result causing property damage, personal injury, or loss of life.



FIRE INSPIRED®

Table of Contents

1 Important Safety Information	3
Technical Support	3
Symbol Legend	4
Important Safety Information for Installers	5
Important Safety Information for End-Users.....	6
2 Product Features and Parts List	7
3 Selecting the Fireplace Insert Location	8
4 Minimum Fireplace Cavity Size	9
5 Fireplace Enclosures Requirements	10
6 Installing the Fireplace Insert	15
7 Adding Approved Media	16
8 Operating the Fireplace Insert	17
9 Maintaining the Fireplace Insert	18
10 Troubleshooting	24
11 Wiring Diagram	26
12 Replacement Parts	27
13 Warranty	28

1 Important Safety Information

- Hearth Products Controls Company recommends that our products are installed by professionals locally licensed by the authority having jurisdiction in gas piping. All installation instructions must be followed to ensure proper performance and safety. Hearth Products Controls Company assumes no responsibility for problems relating to the installation.
- To qualify for warranty, all instructions must be strictly followed. Otherwise, warranty may be void. Never alter product or configuration in any way.
- Annual servicing should be handled by professionals certified in the US by the National Fireplace Institute (NFI) as NFI Gas Specialists or in Canada by WETT (Wood Energy Technical Training).
- It is the installer's responsibility to ensure a safe installation and to educate the end-user regarding the features, safety recommendations and proper operation of this product.
- Please reference page 1 for all warnings.



Technical Support

For information and support contact your Hearth Products Controls dealer.

1 Important Safety Information

Symbol Legend



This is a Safety Alert Symbol

When you see this symbol on the EI Control Panel, or in this manual, look for one of the following signal word panels alerting you to the potential for personal injury, death or major property damage.



Necessary instructions



1 Important Safety Information

Please reference page 1 for all warnings.

Important Safety Information for Installers

Leave this manual with the end-user and instruct them to retain it for future reference.

Installers must carefully follow the instructions in this manual to prevent personal injury or property loss. These instructions contain information critical to the safe installation and operation of the fireplace.

- Instructions are updated as needed.
- It is the responsibility of the installer to follow:
 - The National Fuel Gas Code, ANSI Z223.1/NFPA 54 or International Fuel Gas Code.
 - Natural Gas and Propane Installation Code CSAB149.1 or CSA B149.2
 - The National Electrical Code, ANSI/NFPA 70. In Canada, Canadian Electrical Code CSA 22.1.
 - Local codes
- **Control options:** Use of wall switch, optional remote control (#578-C), automatic shut-off timer or whole house system.

Gas

- Only use the gas/fuel type specified for this fireplace insert, refer to the label on the EI Control Panel. Never use an alternative fuel to include biofuel, ethanol, lighter fluid or any other fuel.
- Gas pressure and type should be checked prior to use and installation.
 - **Natural Gas Fire Pit:** Supply Pressure: Minimum: 6.0 inches W.C.; Maximum: 7.0 inches W.C.
 - **LP Gas:** Supply Pressure: Minimum: 8.0 inches W.C.; Maximum: 11.0 inches W.C.

IMPORTANT

If pressure is low, this will reduce flame height on HIGH setting, possibly resulting in little to no flame variation.

1 Important Safety Information

- If not using supplied flex line, ensure any flex line that may be used from the permanent main fuel supply to the product is rated to the stated max BTU of the product and certified to ANSI Z21.75*CSA 6.27.
- The EI Series is not for use with small LP Tanks and must utilize permanent fixed piping for fuel supply.

Electrical

- Verify correct 120 VAC – 1 amp or 24 VAC – 4 amp power supply. Only use the type specified for this fireplace insert. Refer to the label on the EI Control Panel. All electronic applications should utilize a GFCI-protected circuit.
 - If removing power cord plug and hard wiring within junction box, use only a certified Electrician and must follow the National Electrical Code (NEC), NFPA 70 and all local codes.

IMPORTANT

24 VAC powered fireplace inserts:

- Fire Pit will not perform properly if power supply rating is below 100W or wire size is too small.
- HPC highly recommends using our HPC/Sebco 24 VAC 100W power supply series (311-PS1, 311-PS3, 311-PS5 Models)

A Class II 24 VAC, 4 amp, 100 W transformer must be used to power the EI Control Panel and be able to be switched on and off from a remote location to allow for easy access or emergency.

- 24 VAC wire sizing: Wire lengths 75 ft or less: 14 gauge
- Wire lengths 76 ft or more: 12 gauge

Important Safety Information for End-Users

- Never leave an operating fireplace insert unattended or with someone not familiar with its operation or emergency shut-off locations.
- Both children and adults should be alerted to the hazards of high surface temperatures and should stay away to avoid burns and clothing ignition.
- Young children should be carefully supervised when they are in the area of the fireplace.
- Keep the appliance area clear and free from combustible materials, gasoline, and other flammable vapors and liquids.

2 Product Features and Parts List

Product Features

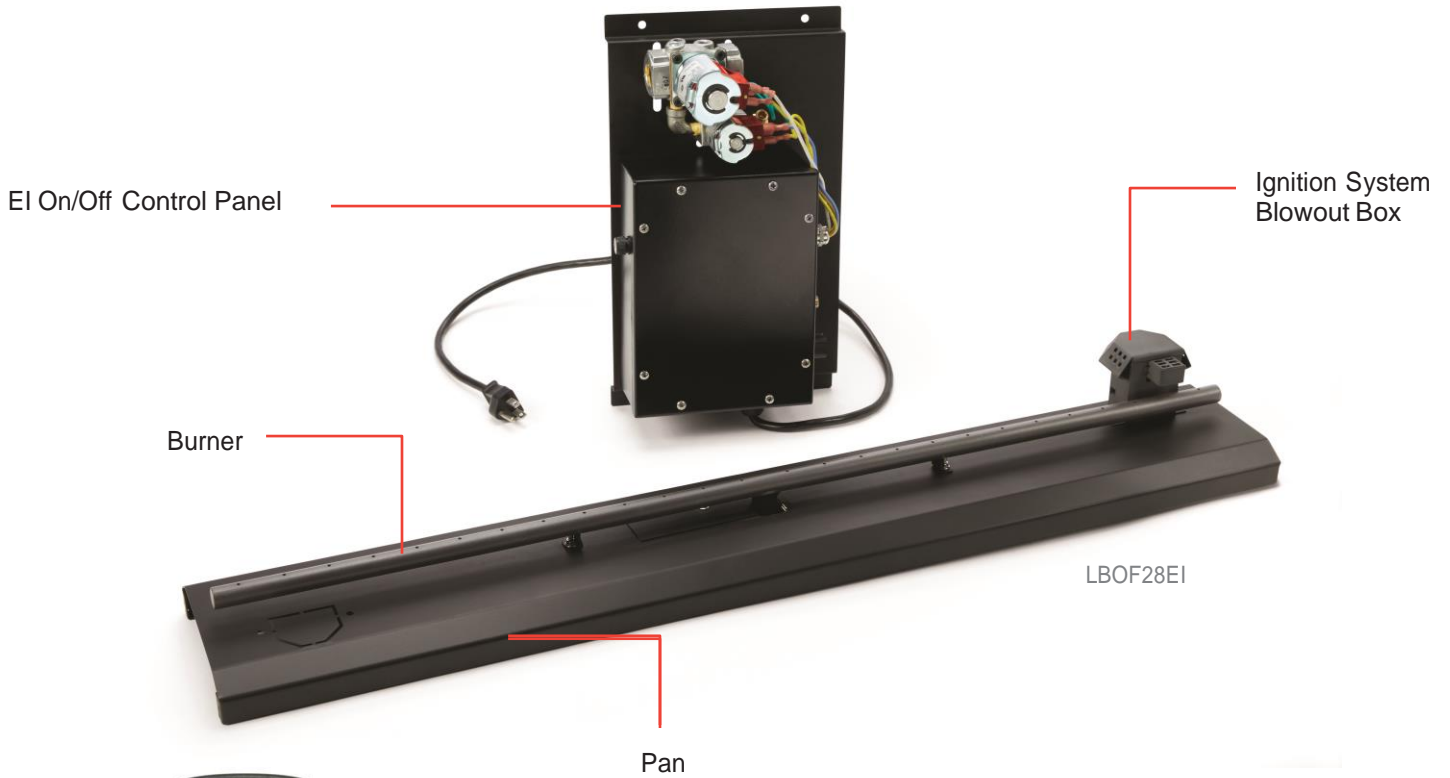

Parts List

- Fireplace Insert
- EI Control Panel
- Gas Input Flex Line – 24"
- Installation and Operation Instructions
- Remote Control (Bluetooth) & Antenna Extension Cable



Antenna Extension

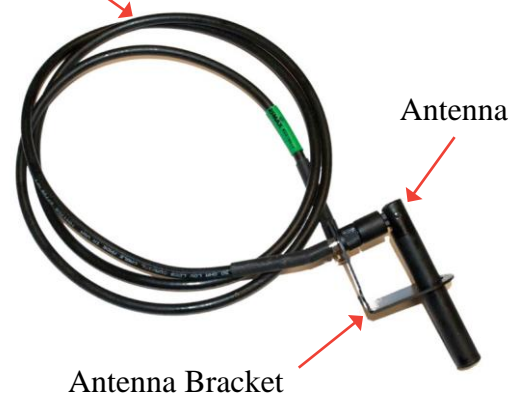

Remote Control

3 Selecting the Fireplace Insert Location

NOTE: All fireplace inserts and systems are designed and intended for outdoor use only.

IMPORTANT

It is recommended that material such as granite, marble or other dense stone be kept away from heat and especially flame due to risk of cracking. HPC is not responsible for damage resulting from failure to follow these recommendations.

- Select a location that
 - ensures above-grade installation of the fireplace.
 - allows easy access for installation and maintenance of the fireplace.
 - provides sufficient horizontal room to enjoy the fireplace while allowing a safe distance from the heat and flame.
- Fireplace inserts create very high temperatures. For clearances refer to table 4.1. Clothing or other flammable materials should not be placed on or near fire pit.

4 Minimum Fireplace Cavity Size

Clearances around Fireplace Insert

It's important to review the clearance requirements below for any type of overhead structure to ensure that the distances are met. Tables 4.1 and 4.2.

PART NUMBERS	MINIMUM FIREPLACE CAVITY SIZE		
	HEIGHT (A)	FRONT OPENING WIDTH (B)	DEPTH (C)
DBOF22EI	18"	36"	18"
DBOF28EI	18"	42"	18"
LBOF22EI	18"	26"	18"
LBOF28EI	18"	42"	18"
LBOF46EI	18"	60"	18"
LBOF58EI	18"	72"	18"
LBOF70EI	18"	84"	18"
LBOF82EI	18"	96"	18"

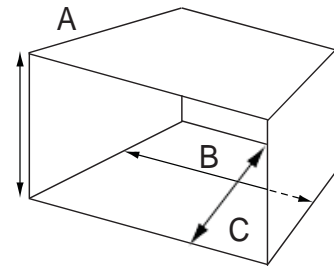

Table 4.2 – Cavity dimension key

Table 4.1 – Clearances for standard fire pit up to 200k BTU

We recommend all mantels made from noncombustible material. If using combustible materials, follow the guidelines below. Table 4.3.

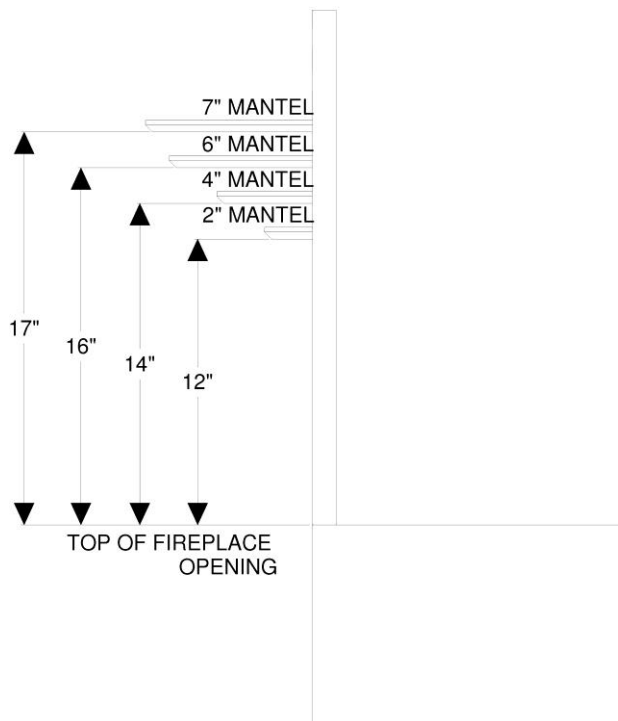

Table 4.3 – Combustible Materials clearances for mantels

5 Fireplace Enclosure Requirements

Location and design

- Refer to cut sheets on our website for important dimensional information for your fireplace insert.
- It is recommended that material such as granite, marble or other dense stone be kept away from heat and especially flame due to risk of cracking. Manufacturer is not responsible for damage.
- The enclosure must be constructed on a stable surface and be level.
- The product must be accessible for service.
- EI Control Panel must be mounted at a minimum of 24" above ground
- Fireplace enclosure should be built and inspected by a certified professional following all local codes.

NOTE: HPC cannot guarantee the fireplace insert pan on all of our products will be perfectly flat and will not warp due to heat.

Gas

- Fireplace must have a gas shutoff on the exterior of the fireplace to allow for emergency shut off and maintenance. The gas shutoff should NOT be used to adjust flame height.
- Fuel line sizing is the responsibility of the installer and must be able to supply the stated maximum BTU for the product – refer to product label on EI Control Panel.
- Gas lines should be behind or to the side of the fireplace insert. See Figure 5.1. Center fireplace in opening.

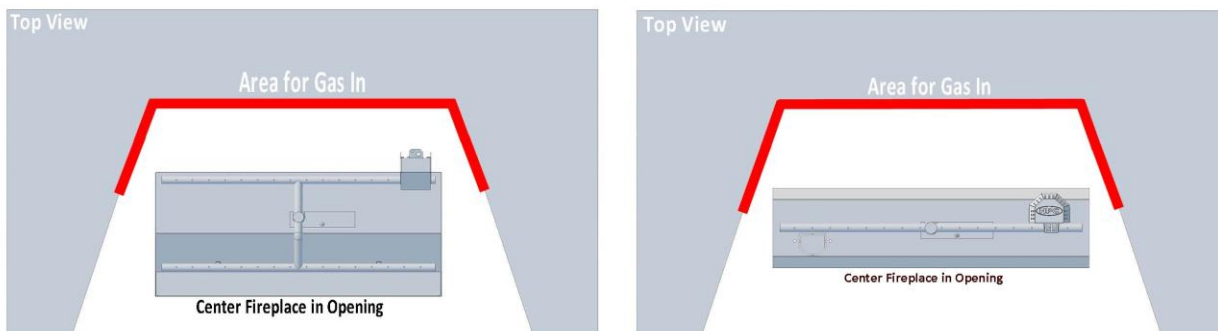

Figure 5.1 – Gas lines and fireplace locations

5 Fireplace Enclosure Requirements

Construction materials

- Use non-combustible materials and construction for gas supply, power and enclosure.

Venting if Enclosing EI Control Panel

- The enclosure must incorporate vents to allow heat and or residual fuel to escape. Failure to properly vent the enclosure may result in the fireplace overheating or explosion.
- Some enclosures may require more ventilation based on material, size, and extended use.
- Failure to properly vent the enclosure may result in the fireplace overheating or explosion. Continuous overheating could lead to heat damage to internal components.
- **OVERHEATING:** the fireplace will automatically close the gas valve if the temperature exceeds 190°F inside the control box to prevent component damage. Turn main power to the fireplace off and on to reset. To correct overheating, ensure enclosure has adequate ventilation per the guidelines in this section.
- Ensure enclosure has adequate ventilation per the guidelines in this section.

5 Fireplace Enclosure Requirements

Fuel line

- Fireplace must have a gas shutoff on the outside of the exterior of the fireplace to allow for emergency shut off and maintenance. The gas shutoff should not be used to adjust flame height.
- The installer is responsible for using the correct fuel line sizing that is able to supply the stated maximum BTU for the product – refer to product label on the fireplace for specifications.

INSTALLATION

We suggest that our products be installed by professionals that are locally licensed by the authority having jurisdiction in gas piping.

- Perform all leak tests with leak detector or leak reactant.

IMPORTANT To prevent damage, isolate the appliance when performing any pressure testing.

IMPORTANT *Burn Testing:* It is the responsibility of the qualified installer to test for gas leaks at all connections.

IMPORTANT *Gas Plumbing Connections:* Use joint compound or tape that is resistant to all gases. Apply joint compound only to all male pipe fittings. **DO NOT use on flex line flared fittings.** Be sure to tighten every joint securely.

Installation Steps:

1. Set fireplace insert in properly constructed fireplace enclosure, read **Section 5 – Fireplace Enclosure Requirements**.
2. Position fireplace insert following safety recommendations with access to all gas connections for testing. Read **Section 3 – Selecting the Fireplace Insert Location** for more details.
3. Mount the EI Control Panel on the outside of the fireplace at least 24" off the ground and in the vertical position, 4 screws (not included). See Figure 6.1.
4. Mount optional antenna extension cable – see page 15. Antenna must be mounted in a location with line of sight.
5. Shut off gas supply to fireplace.
6. Connect proper 120 VAC or 24 VAC electrical power following all local codes.
7. Connect EI Control Panel to main gas supply. Warning: avoid sharp bends with flex line to prevent whistling.

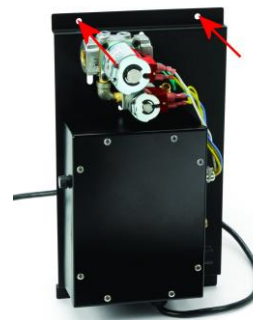

Figure 6.1 – EI Control Mount

5 Fireplace Enclosure Requirements

8. Turn on gas supply, purge gas lines of air and perform leak test on all inlet connections. Repair as needed.
9. Initial Start-up after install:
Several "ON/OFF" cycles may be necessary to purge air in gas lines after system installation.
 1. Turn "ON" electrical power to fire pit via wall switch or breaker.
 2. Turn "ON" gas to fire pit.
 3. Remove Blowout Box lid to allow viewing of hot surface igniter.
 4. Pointing remote control towards antenna, press and release the Power ON/OFF button, Figure 6.2.
NOTE: Remote Control LED- 2 flashes indicates signal received.
 5. Hot surface igniter should begin to glow within 10 seconds.
 6. Pilot flame will eventually igniter. NOTE: This may take several cycles due to air in the gas line. Unit will lockout after 15 cycles- to reset, please turn "OFF" electrical power using wall switch or breaker then turn "ON", repeat step 4.
 7. Main burner will igniter.
 8. Pointing remote control towards antenna- test High/Low function.
10. Once fireplace insert is lit, perform leak test on all gas connections. Repair as needed.
11. Turn off EI Control Panel and allow it to cool.
12. Apply media as described in **Section 7, Adding Approved Media**. When filling the pan with lava rock and/or decorative glass, the instructions in Section 7 must be followed.
13. Turn on EI Control Panel again and perform leak test with media correctly installed. If gas leak is detected verify correct media application and repair as needed.
14. Verify correct operation and lighting.
15. Review safety manual with end-user. Instruct end-user that fireplace insert, EI Control Panel or media must not be changed or modified.
16. Leave manual with end user.
17. Apply the Start Up and Shutdown decal next to EI Control Panel in an obvious and highly visible position.

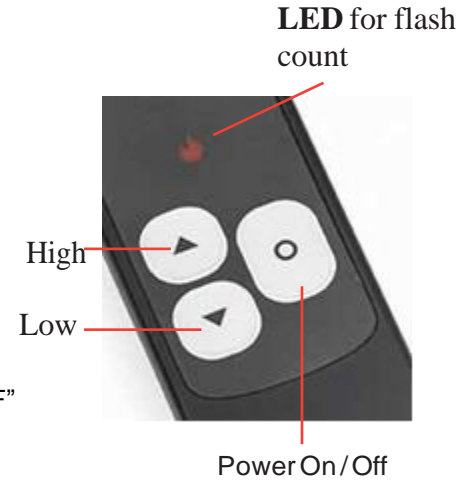

Figure 6.2 – Remote.

6 Installing the Fireplace Insert

Antenna Extension Cable Mounting (Optional)

Begin by deciding where the antenna bracket will be installed, depending on the type of enclosure, Figure 6.2.

- 1) Antenna must be installed on the outside of the enclosure.
- 2) Place antenna on side where most usage will occur and line of sight.

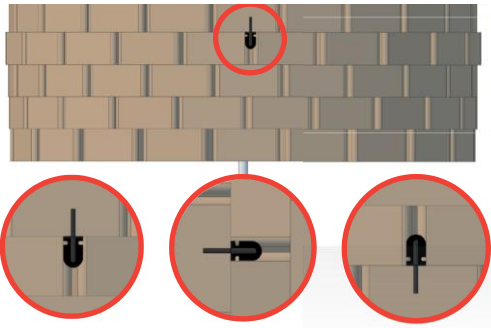

Figure 6.3 – Antenna placement

- Plot the hole locations that will be drilled to fasten the antenna bracket. See Figure 6.3.

NOTE: The two smaller holes are for fastening the bracket and the one larger hole is for the antenna cable to slide through. When drilling holes, ensure there is no debris and that the antenna cable hole is large enough to not damage the antenna cable.

- Drill hole for antenna using the proper drill bits depending on the type of finish on the enclosure.
 - The recommended hole size for the antenna is 3/8" (.375").
- After drilling, dry fit the bracket while sliding the antenna bracket into the enclosure. Figure 6.4
 - Mark holes for fastening bracket to enclosure
 - Drill holes for fasteners
- Fasten down the bracket by using proper fasteners depending on the type of finish on the enclosure, Figure 6.5.
 - Example: For brick finish use Tapcon® screws.
- Attach antenna cable end onto the valve box being careful not to damage center pin, lightly tighten with wrench to ensure connection. Figure 6.6.

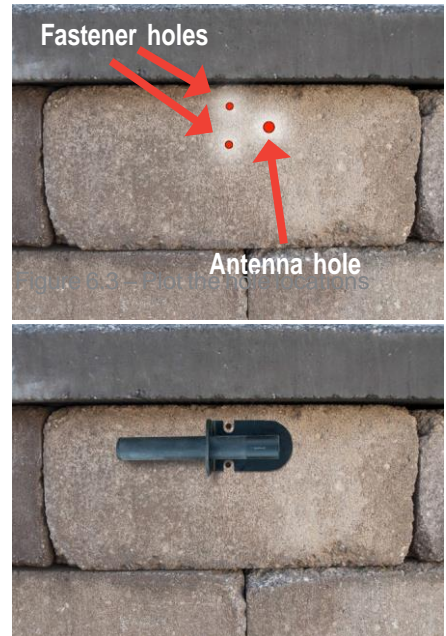

Figure 6.5 – Dry fit the bracket



Figure 6.6 – Fasten down the bracket



Figure 6.7 – Attach antenna cable

6 Installing the Fireplace Insert



WARNING

FOR GLASS MEDIA USAGE WITH LP GAS - WHEN USING APPROVED DECORATIVE GLASS TO COVER BURNER APPLY ONLY ENOUGH TO HIDE BURNER. APPLYING OVER 1/2" MAY CREATE BACK PRESSURE AND GAS LEAKAGE FROM AIR MIXER RESULTING IN LP POOLING.



WARNING

FOR GLASS MEDIA USAGE WITH LP GAS - THE UNIT MUST BE TESTED WITH MEDIA OVER BURNER FOR CONFIRMATION OF NO BACK PRESSURE CREATING GAS TO LEAK OUT OF AIR MIXER VENTURI HOLES.



WARNING

NEVER USE ANY MATERIAL THAT IS NON-POROUS OR HOLDS MOISTURE SUCH AS GRAVE, PEBBLES, RIVER ROCK, ETC. WHEN HEATED, NON-POROUS MATERIAL WILL NOT ALLOW HEATED STEAM TO READILY ESCAPE WHICH CAN BREAK AN CAUSE PERSONAL INJURY OR DAMAGE. MATERIAL THAT HOLDS MOISTURE CAN BOIL AND FRACTURE UNEXPECTEDLY WHEN EXPOSED TO HEAT.

IMPORTANT

The fireplace insert is designed to use approved media correctly installed over the burner to achieve proper combustion.

- Never install a mesh or screen under the media.
- Media affects flame pattern greatly. It is possible to create an unusual flame pattern that could damage your enclosure. Enclosure damage from an open flame fire feature is not covered under any warranty.



DBOF inserts height adjustments are located on the rear of the pan. Adjust height as needed, not necessary, to achieve the desired flame presence.



7 Adding Approved Media

Application of Approved Media

Please follow the instructions below to add the finishing touch to your fireplace insert. Particular attention needs to be on the pilot assembly area.

Incorrect media installation will cause the pilot flame to suffocate and turn off fireplace insert or delay main burner ignition.

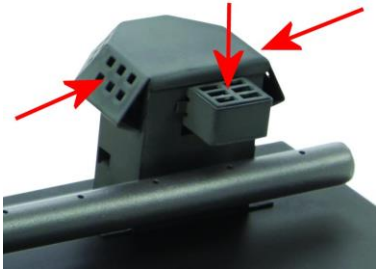
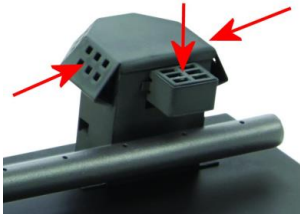
Lava Rock Only Application	Decorative Glass Application
<p>3) Install your fireplace insert per instructions.</p> <p>4) Apply lava rock ONLY deep enough to cover burner.</p> <p>5) Blowout Box: Leave vents open. Do not cover vents with lava rock or allow any rock to block flame opening. Incorrect media installation will cause the pilot flame to suffocate and turn off fireplace insert or delay main burner ignition.</p>  <p>DO NOT COVER THE VENTS</p>	<p>1) Install your fireplace insert per instructions.</p> <p>2) Fill pan with media. Cover burner with 1/4 to 1/2 inches of glass. Do not overfill pan with glass. All LP installations must be checked for back pressure with media installed. Failure to do so may result in personal injury or property damage.</p> <p>3) Blowout Box: Do not cover blowout box vents or opening with glass. Incorrect media installation will cause the pilot flame to suffocate and turn off fireplace inset or delay main burner ignition.</p>  <p>DO NOT COVER THE VENTS</p>

IMPORTANT

For log sets, place logs where they are NOT directly in the flame but has the best aesthetics for the fire.

8 Operating the Fireplace Insert

- Before use, be sure to test all gas connections for leaks. Do not use fireplace insert if there is any evidence of leaking gas. If leaking gas suspected, turn off the main gas supply and repair immediately.
- Do not use the enclosure as a seating area. Wind and gusty conditions will affect the flame in an unpredictable manner. If conditions exist that are not safe for patrons, turn off the fireplace insert.
- The hose should be inspected before each use of the fireplace insert and replaced prior to use if there is evidence of excessive abrasion or wear or if the hose is damaged. The replacement hose assembly shall be that specified by the manufacturer.
- Do not use the fireplace insert if any part has been under water. Immediately call a qualified service technician to inspect the unit and to replace any part of the control system and any gas control that has been under water.
- Never use any material that is non-porous and holds moisture such as gravel, pebbles, river rock, etc. This material, when heated will cause the trapped moisture to boil and fracture unexpectedly. This material is not sufficiently porous to allow heated steam to readily escape which can break and cause personal injury or damage.
- Solid fuels shall not be burned in the fireplace insert.
- Leaves, sticks, wood, paper, clothing, food material, should be kept away from the fireplace insert. Clothing or other flammable materials should not be hung from the appliance or placed on or near the appliance. Keep the appliance area free from gasoline, and other flammable vapors and liquids.
- Fireplace insert is not for cooking.
- Make sure that there is no vegetation or other objects over the top or sides of the fireplace insert that could interfere with safe operation. See clearances in **Section 3 – Selecting the Fireplace Insert Location**.
- If lava rock is wet, allow the fire pit to burn for 45 minutes prior to coming within 15 feet of the fireplace insert.
- When the unit is not in operation, turn off gas valve.

9 Operating the Fireplace Insert

Start-up

Initial Start-up: Several “ON/OFF” cycles may be necessary to purge air in gas lines after system installation. EI Control Panel will lockout after 15 attempts to light pilot, please power OFF then ON to restart.

Sequence of Operation:

1. The igniter will be powered (glow red) for five seconds before pilot valve opens.
2. The igniter will only be powered the initial 15 seconds of the 30-second pilot cycle. This sequence will repeat up to 15 times (approximately 15 minutes) before going into lockout. To reset, turn “OFF” power then back “ON” again.
3. Pilot flame will ignite and warm thermocouple; it may take 30 seconds at times for thermocouple to get hot. If thermocouple is not hot in 60 seconds, system will shut down. If this occurs, go back to Step 1.
4. Once thermocouple is hot, main valve will open allowing main burner to ignite.
5. If pilot flame is blown out at any time, system will shut down, and then automatically restart (Step 1).



DANGER

If you smell gas:

- 1) Shut off gas to appliance.
- 2) Extinguish any open flame.
- 3) If odor continues, keep away from appliance and immediately call gas supplier or fire department.

EI Fireplace Start Up- Bluetooth HI/LOW

1. **STOP! Read the safety information on “What to Do If Smell Gas” (Pg. 1).**
2. Confirm there is no debris in the fireplace insert (as mentioned in warnings) including water.
3. Turn “ON” electrical power and gas to EI Control Panel.
4. Using remote or app to turn “ON” EI Control Panel - this may take several cycles to purge any air.
5. To reset after lockout, power unit down, wait 5 minutes, then restart.
6. Once the fireplace insert has ignited **DO NOT** leave unattended.

This product is not for use with small tanks.

EI Fireplace Shutdown

1. Turn “OFF” fireplace insert using remote or app.

IMPORTANT

FOR REMOTE CONTROL USE, YOU MUST ALSO TURN OFF POWER TO ELECTRICAL OUTLET OR GAS TO FIREPLACE INSERT TO PREVENT ACCIDENTAL START.

9 Operating the Fireplace Insert

The following sections explain operation of:

- Remote control **B.** Smartphone control

A. HPC Remote Control – After turning ON the gas to fireplace insert, operate as follows:

1. Normal Remote Operation – Figure 8.1

- a. Power ON/OFF – 2 Flash
- b. High – 4 Flash
- c. Low – 3 Flash
- d. Poor Communication – 10 Flash (Move closer or change positions.)
- e. Remote Response Time – When not in use for more than 30 seconds, the remote will go into a sleep mode to save battery life. If remote is in sleep mode it may take a few extra seconds for a command to be executed.



Figure 8.1

2. Remote sync – The remote is already synced to the EI Control Panel. Figure 8.2

- a. If you need to sync the remote to a fire place insert:
 1. Ensure power is OFF to fireplace insert.
 2. Depress the LOW and OFF button simultaneously and hold until the remote flashes rapidly (8 to 10 seconds)
 3. Release the LOW and OFF buttons
 4. Apply power to the fire pit within 10 seconds – Fire pit will accept a new remote for the first 60 minutes it is on.
 5. Allow the remote to finish flashing which could take up to 30 seconds
 6. Your remote should operate the fireplace insert



Figure 8.2

NOTE: If steps 5 or 6 fail, please repeat Steps 1 through 7. Also confirm antenna is in a location to receive signal from remote.

IMPORTANT

The maximum of devices that can be paired to a HI/LO fire pit at one time is 9 devices. This includes the remote control that comes with your HI/LO fire pit and your smartphone or tablet. When pairing the tenth device the first four paired devices will be removed from memory and the sequence starts again.

9 Operating the Fireplace Insert

3. **Remote Range** – The remote should reliably operate within a 25-foot distance from your fireplace. Greater distances may be possible depending on your particular application. Antenna extension cable is available when needed. See Figure 8.3.

- a. Metal objects negatively affect communication between the remote device and your fire pit. Objects such as metal enclosures, metal grates and metal mesh for stone veneer or in some cases metal furniture may interfere with communication between your remote device and the fireplace.

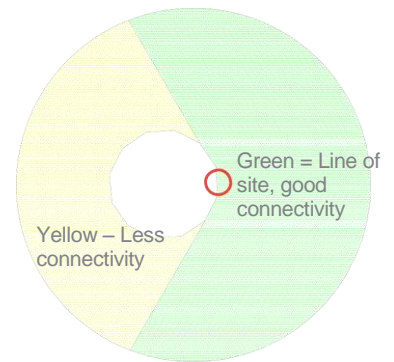

25" Diameter

Figure 8.3

4. **For lost remote** – If the remote is misplaced, the fireplace may still be turned on by the following method:

- a. Apply power for 5 seconds; turn off for at least 5 seconds. (Repeat three times, all times for +/- 1 second).
- b. Next time unit is powered up it will turn ON. Fireplace can still be turned off with the remote. Once power is removed, start over with step a.

If power to the EI Control Panel is turned off, then immediately turned back on, the system will go into lockout mode. To reset, turn off, wait five minutes, then turn back on.

B. Smartphone Control – After turning ON gas, follow the app instructions.
Figure 8.4



9 Operating the Fireplace Insert

El app Instructions

App setup and usage

NOTE:

- The content of the app or the design is subject to change. Support for apps may be discontinued without notice, depending on the content provider’s policy.

- Adult use only.

ATTENTION:

- When pairing a device with the fire pit, only one Bluetooth® connection can be used. Turn Bluetooth “OFF” to allow other devices to connect to the fire pit.

Setting up the App:

3. Download the HPC Fire app from the  Apple store or Google Play.

4. If power to the fire pit is already applied, disconnect power for 20 seconds and reconnect power.

5. Open the HPC Fire app, Figure 8.5.

6. From the home screen, enter 6 characters; this is your login name or security key, Figure 8.5.

7. Confirm the security key and type login name again, Figure 8.5.

8. Select your language, and press “Continue”.

9. Enable the Bluetooth and return to the HPC Fire app, Figure 8.6. If prompted to allow access to your files and location – tap Allow

NOTE: For Apple devices accept the pairing request.

10. Tap on Fire Pit 1, Figure 8.7.

11. Enter the default security code 2345 and press “Connect”, Figure 8.8. Repeat until app is connected to the fire pit.

Note: If the app will not pair with the fire pit, disconnect power for 20 seconds and exit the app, and repeat the install steps above.



Figure 8.5

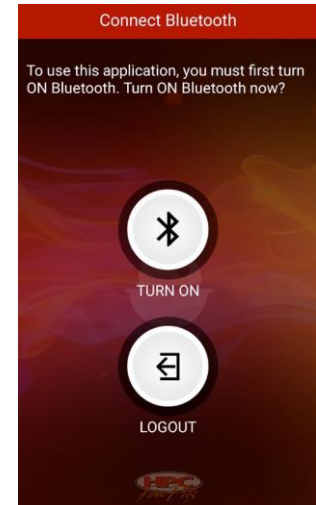

Figure 8.6

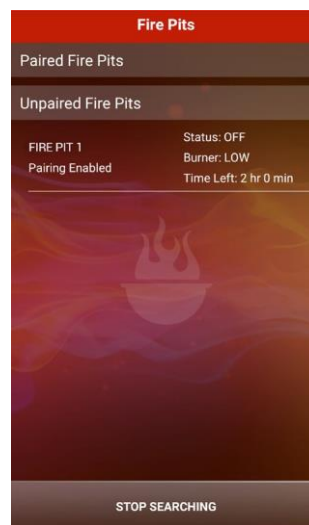

Figure 8.7

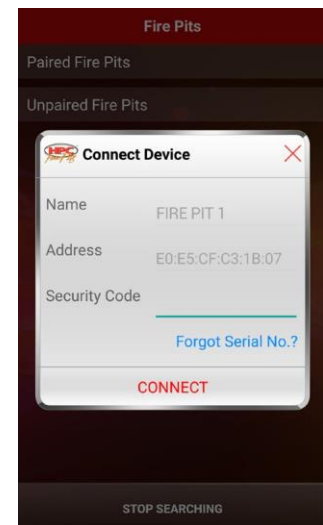

Figure 8.8

9 Operating the Fireplace Insert

Status

Power ON/OFF: Answer two safety questions when powering on unit.

Flame – HIGH/LOW

Timer – amount of time left before shutoff.

Troubleshoot guide – reference for troubleshooting issues.

Setup –

1. Timer ON/OFF and set the timer.
2. Customize the fire pit's name.
3. Customize the security code.

Dashboard

ON/OFF Indicator

Temperature Indicator – inside fire pit control module

Timer – amount of time left before shutoff.

Website link to hpcfire.com

9 Operating the Fireplace Insert

- Any guard or protective device removed for servicing must be replaced prior to operating the fireplace insert.
- We suggest that our products be serviced annually by a professional certified in the US by the National Fireplace Institute (NFI) as NFI Gas Specialists.
- Ensure gas is shut off and fireplace insert is cool before servicing.
- In some areas of the country, spiders or insects have been known to build nests and/or lay eggs in the venturi holes of the air-mixer for LP units. This can cause fuel to fill the fire feature cavity and result in personal injury or property damage. Periodic inspection by a qualified service technician of the air-mixer is required to ensure your fire feature performs properly.
- **Burner Cleaning: One time a year.** If flames exhibit any abnormal shapes or behavior, or if burner fails to ignite properly, then the burner holes may require cleaning. The appliance can be cleaned by carefully removing the logs and media to allow access to burner. Use a brush to carefully remove dust, spider webs, and loose particles from base, logs, and fire ring itself. If evidence of damage, burner must be replaced with burner specified by the manufacturer.
- **Thermocouple cleaning of soot: Once every six months or as needed.** Remove lava rock & glass around pilot, then the blowout box lid. Clean thermocouple of any soot using soft brush. Be careful not to damage hot wire element. Place lava rock or glass back as explained in **Section 7 – Adding Approved Media**.
- **Visually inspect the pilot.** The pilot flame should cover 3/8 inch to 1/2 inch of the thermocouple. Cleaning of the pilot orifice may be required by removing pilot hood counter clockwise and removing orifice.

Service



We suggest that our products be serviced by a professional certified in the US by the National Fireplace Institute (NFI) as NFI Gas Specialists.



LBOF Fireplace Inserts

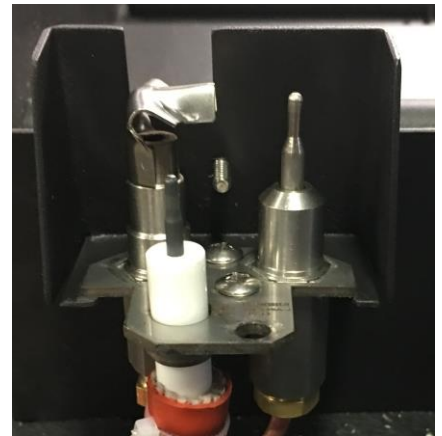

DBOF Fireplace Inserts

10 Troubleshooting

Table 10.1, below indicates some potential causes and countermeasures to the symptoms indicated in bold type. **Please contact your retailer or certified technician for service and repair.**

- The error number and description are shown in the troubleshooting tab in the app or the number of blinks on the remote.
- For Override Start Up Mode see next page

Service



We suggest that our products be serviced by a professional certified in the US by the National Fireplace Institute (NFI) as NFI Gas Specialists.

Error Number & Description	Problem	Possible Causes	Solution
1 Igniter failure 6 Igniter open	Pilot Will Not Light	Air in gas line	New install – May take several attempts
		No gas flow – Gas not ON or line obstruction	Confirm gas is ON upstream Possible debris in line – insulation, dirt, plastic, etc.
		Pilot orifice dirty or clogged	Remove orifice and clean (Section 9)
		Gas pressure improper	Confirm proper gas pressure (Section 1)
		Igniter element damaged	Change igniter element
		Damaged wires	Inspect wires to igniter. Confirm insulation is in good condition and connections are tight
3 Thermocouple error 4 Hardware fault 5 Flame at startup	No Main Burner (Pilot Flame Present)	Loose thermocouple at valve box	Tighten down connection at valve box. Should be tightly snug.
		Thermocouple cracked/broke under pilot assembly	Replace thermocouple
		Gas pressure improper	Confirm proper gas pressure (Section 1)
		Small pilot flame	Remove pilot head and clean orifice (Section 9)
		Dirty thermocouple	Clean using soft brush
		Fire ring obstructed	Confirm no debris or water in ring
		Improperly applied media	See Section 7.
		Pilot flame present at all times	Possible debris inside valve
Main Burner Turning Off/On Frequently	Main Burner Turning Off/On Frequently	Small pilot flame	Remove pilot head and clean orifice (Section 9)
		Improperly applied media	See Section 7.
		Gas pressure improper	Gas pressure too low (Section 1)
		Thermocouple defective	Change thermocouple
2 Over temperature 7 Broken communication 8 Not paired 9 Out of range 10 Internal control fault or Over temperature	No Power or Response from Unit	No power to unit	Confirm breaker, wall switch and remote are on
		Remote not working	Change batteries
			Re-sync remote (High/Low models only)
		Has power to unit but will not cycle	Check external fuse (5A)
			Check voltage to unit Module sensing wrong voltage. Replace module and transformer
		Over temperature	Inadequate venting see proper venting in Section 5. Power OFF then back ON to reset
		Has power to unit but remote or app will not communicate	Reconnect by pairing to unit, power unit OFF then back ON at power supply to reset.
			Out of range, move closer to unit to allow communication and ensure align of sight
			Transceiver not communicating with module. Check communication cable and ensure indicator light on transceiver is on.

Table 10.1 – Troubleshooting

10 Troubleshooting

Override Start Up Mode

In the event of lost or damaged remote control / smart device or poor Bluetooth connection, the fire pit may be temporarily started in the Override Start Up mode using a unique sequence of applying supplied power "ON" & "OFF".

Override Start Up:

The power application sequence is as follows using a wall switch, breaker or unplugging power cord:

1. Supplied Power is "OFF" to fire pit.
2. Power "ON"- 5 seconds exactly.
3. Power "OFF"-2 seconds exactly.
4. Repeat Steps 2 & 3- two more times.

Power & leave "ON". The fire pit will eventually start and operate at the default HIGH setting only.

*Please note the remote control or smart device will not function in this mode.

Shut Down:

1. To turn "OFF" fire pit, please turn "OFF" supplied power.

11 Wiring Diagram

120VAC Models:

(Included in EI Control Panel)

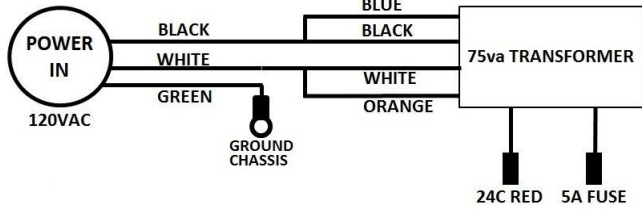

24VAC Models:

(Power supply sold separately)
311-PS1, 311-PS3, 311-PS5

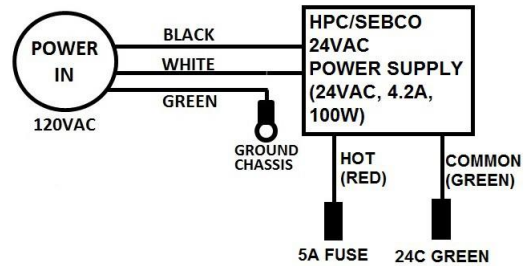

NOTE: 100W Output Required

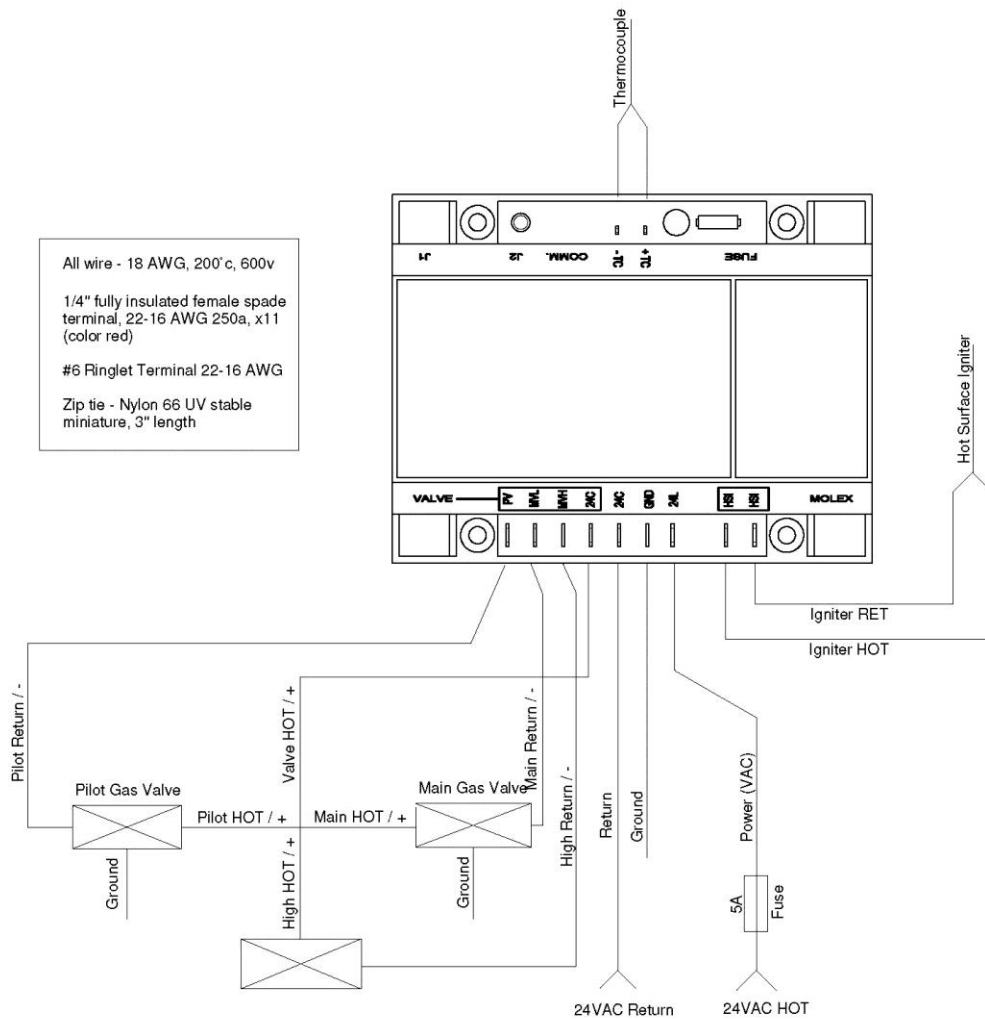

12 Compatible Accessories

Please contact your dealer for parts – if unsure please contact HPC

13 Replacement Parts

Please contact your dealer for parts – if unsure please contact HPC

14 Warranty

Warranty

Hearth Products Controls Co. (HPC) warrants fire pits against manufacturing defects that prevent safe and correct function as follows:

1) **Stainless Steel Fire Pit and Outdoor Fireplace Burners - Lifetime Warranty**

Limited Warranty:

2) Electronics, Gas Valve: Commercial-1 year; Residential-3 year.

3) Pilot Assembly: Commercial-1 year; Residential-2 year.

Stainless Steel Pan, Valve Box: Commercial-1 year; Residential-5 years

Warranty commences from the date of original sale / shipment from HPC FOB Dayton, Ohio. This warranty is for parts and in-house (HPC) labor. The defective product must be sent back to HPC with a Return Merchandise Authorization (RMA) issued by HPC for that specific product and any other additional information for the nature of the defect or warranty claim. The warranty does not cover items that have been damaged by overheating, modification, abuse, or improper storage. Also any labor involving installation or maintenance with the unit is not covered. This warranty excludes claims for consequential, indirect-collateral expenses arising from product defects or warranty recovery.

Rev.0 5/8/2019



FIRE INSPIRED™
Hearth Products Controls
Fire-inspired since 1975.