



**Marbella™**  
Artisan Fire Bowl



**KINDRED**  
OUTDOORS + SURROUNDS



<b>INTRODUCTION</b>	<b>3</b>
<b>SAFETY WARNINGS</b>	<b>4</b>
<b>DIMENSIONS &amp; DIAGRAMS</b>	<b>7</b>
<b>PARTS LIST</b>	<b>8</b>
<b>GAS REQUIREMENTS</b>	<b>9</b>
LIQUID PROPANE	9
NATURAL GAS	9
<b>SET-UP</b>	<b>10</b>
PLACE FIRE BOWL IN DESIRED LOCATION	10
CONNECT GAS LINE	11
<i>CONNECTION FOR LIQUID PROPANE</i>	11
<i>CONNECTION FOR NATURAL GAS</i>	12
PERFORM A LEAK TEST	12
PLACE DECORATIVE STONE IN FIRE BOWL	13
<b>OPERATING THE FIRE BOWL</b>	<b>14</b>
<b>TROUBLE SHOOTING</b>	<b>15</b>
<b>CLEANING, MAINTENANCE &amp; STORAGE</b>	<b>16</b>
<b>WARRANTY</b>	<b>17</b>

Burners comply with:

**ANSI Z21.97/CSA 2.41-2014** *Outdoor Decorative Gas Appliances*

Tested by **RADCO**, an independent third party testing laboratory, and certified by **ICC-ES**, an accredited certification body. The burners in this fire bowl have been evaluated and certified for both Canadian and USA Markets (CSA Standards). The following information regarding safe operation and maintenance of this appliance is a result of the tests performed by RADCO and certified by ICC-ES.

Models:

**3576** (Liquid Propane) & **3577** (Natural Gas)



The Marbella bowl captures the essence of the Romanesque period. Its gently rounded bull nose and elegant foundation are hand-sanded, creating the natural feel and texture of limestone. The Marbella is perfect for a variety of traditional landscape settings.

Made from strong, glass-fiber reinforced concrete and hand-sanded through a four-step finishing process. Each Artisan Fire Bowl renders a true one-of-a-kind creation with subtle variations in color and texture similar to natural limestone. They're as functional as they are beautiful, incorporating a 65,000 BTU gas burner, providing ample heat on cool nights. Fire Bowls ship complete with lava rock and match-lit components complying with CSA standards for natural gas or liquid propane. Choose from four different colors in either honed or travertine finishes.



Shown installed: The Marbella in Oak Barrel Travertine.



## SAFETY WARNINGS

### ⚠ WARNING

Do not store or use gasoline, or other flammable vapors and liquids, in the vicinity of this or any other appliance.

An LP-cylinder not connected for use shall not be stored in the vicinity of this or any other appliance.

### ⚠ AVERTISSEMENT

Ne pas entreposer ne utiliser de l'essence ni d'autres vapeurs ou liquides inflammables dans le voisinage de l'appareil, ne de tout autre appareil. Une bouteille de propane qui n'est pas raccordée en vue de son utilisation, ne doit pas être entreposée dans le voisinage de cet appareil ou de tout autre appareil.

### ⚠ DANGER

If you smell gas:

- Shut off gas to the appliance.
- Extinguish any open flame.
- If odor continues, keep away from the appliance and immediately call your gas supplier or fire department.

### ⚠ AVERTISSEMENT

S'il y a une odeur de gaz:

- Coupez l'admission de gaz de l'appareil.
- Éteindre toute flamme nue.
- Si l'odeur persiste, éloignez-vous de l'appareil et appelez immédiatement le fournisseur de gaz ou le service d'incendie.

### ⚠ WARNING

FOR OUTDOOR USE ONLY.

### ⚠ AVERTISSEMENT

POUR USAGE À L'EXTÉRIEUR SEULEMENT.

### ⚠ DANGER

#### CARBON MONOXIDE HAZARD

This appliance can produce carbon monoxide which has no odor. Using it in an enclosed space can kill you.

Never use this appliance in an enclosed space such as a camper, tent, car or home.

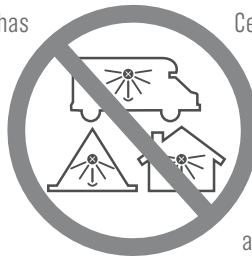

### ⚠ AVERTISSEMENT

#### MONOXYDE DE CARBONE

Cette appareil peut produire du monoxyde de carbone, un gaz inodore.

L'utilisation de cet appareil dan des espaces clos peut entraîner la mort.

Ne jamais utiliser cet appareil dans un espace clos comme un véhicule de camping, une tente, une automobile ou une maison.

### ⚠ WARNING

Improper installation, adjustment, alteration, service or maintenance can cause injury or property damage. Read all the installation, operating and maintenance instructions thoroughly before installing or servicing this equipment.

### ⚠ AVERTISSEMENT

Une installation, un ajustement, une modification, une réparation ou un entretien inapproprié peuvent être la cause de blessure ou de dommages. Veuillez lire attentivement les instructions d'installation, d'utilisation et d'entretien avant d'installer ou de réparer ce matériel.



## SAFETY WARNINGS Continued

### WARNING

#### **CALIFORNIA PROPOSITION 65 WARNING:**

Chemicals known to the State of California to cause cancer, birth defects or other reproductive harm are found in and/or created by the combustion of natural gas, propane, butane and other fuels. Always operate this unit as described in this guide and in well ventilated areas.

Failure to follow all instructions exactly may result in fire or explosion causing property damage, personal injury or loss of life.

We recommend installation is completed by professionals that are locally licensed by the authority having jurisdiction in gas piping. Follow all local codes.

We suggest that our products be serviced annually by a professional certified in the US by the National Fireplace Institute (NFI) as NFI Gas Specialist.

The burner must be replaced prior to the appliance being put into operation if there is evidence of the burner being damaged. A replacement burner should only be used from the original manufacturer.

Failure to position the parts in accordance with diagrams or failure to use only parts specially approved with this appliance may result in property damage or personal injury.

Only use gas/fuel type specified for fire bowl. Verify correct gas/fuel type and pressure by checking label on back side of burner assembly pan. Never use an alternative fuel to include bio-fuel, ethanol, lighter fluid or any other fuel.

### CAUTION

Do not remove the metal data plates attached to the underside of the fire bowl burner. These plates contain important information.

Do not use charcoal or other solid fuel in gas burning appliances.

Do not use your fire bowl for cooking. Do not heat any unopened glass or metal container of food in the fire bowl. Pressure may build up and cause the container to burst, possibly resulting in serious personal injury or damage to the fire bowl.

Never use the fire bowl in windy conditions. If used in a consistently windy area a windbreak will be required. Always adhere to the specified clearances listed in this manual.

Never allow clothing or other flammable materials come in contact with any hot surface until it has fully cooled. Never wear loose fitting or hanging garments while using your fire bowl. Fabric may ignite and result in personal injury.

When handling propane gas line and connectors, do not allow them to come in contact with any metal surfaces.

Do not drop propane connectors.



## SAFETY WARNINGS Continued

### **GAS SAFETY**

In the event that a burner goes out, turn burner knobs to the full **OFF** position and let it air out. Do not attempt to use the fire bowl until the gas has had time to dissipate.

Propane gas source to the fire bowl must be regulated. Do not operate if regulator has been removed. Fire or explosion can occur.

### **BURN HAZARD**

While the fire bowl is operating, the outside surface may reach high temperatures which may cause burns.

Never leave children unattended in the area where the fire bowl is being used. Close supervision of children is necessary when any appliance is used near children. Never leave the fire bowl unattended when in use.

When using the fire bowl, do not touch the rock, fire screen, or immediate surroundings, as these areas become extremely hot and could cause burns.

Do not reach over your fire bowl when hot or in use.

Do not store items of interest to children around or below the fire bowl.

Never allow children to sit or stand on any part of the fire bowl.

### **SAFETY**

Installation and repair should be done by a qualified service person. The appliance should be inspected before use and at least annually by a qualified service person. More frequent cleaning may be required as necessary. It is imperative that the control compartment, burner and circulating air passageways of the appliance be kept clean.

It is the installer's responsibility to ensure a safe installation and to educate the end user as to proper operation of the burner unit. Installer must leave the owner's manual, metal plate with operating instructions, and valve key with the end user.

Clothing or any other flammable materials should not be hung from the appliance, or placed on or near the appliance.

Keep all electrical supply cords away from the heated areas of the fire bowl.



## DIMENSIONS & DIAGRAMS

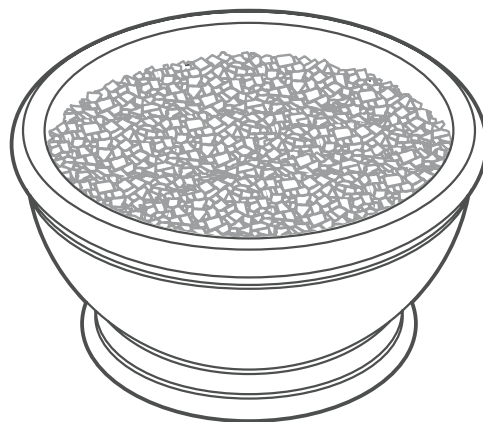
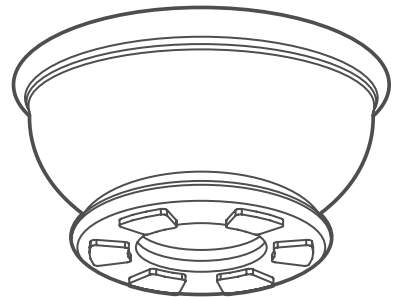
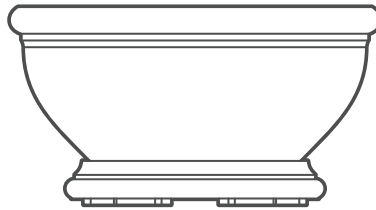
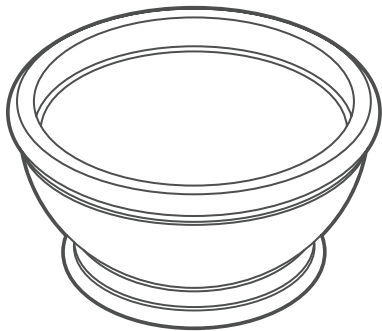
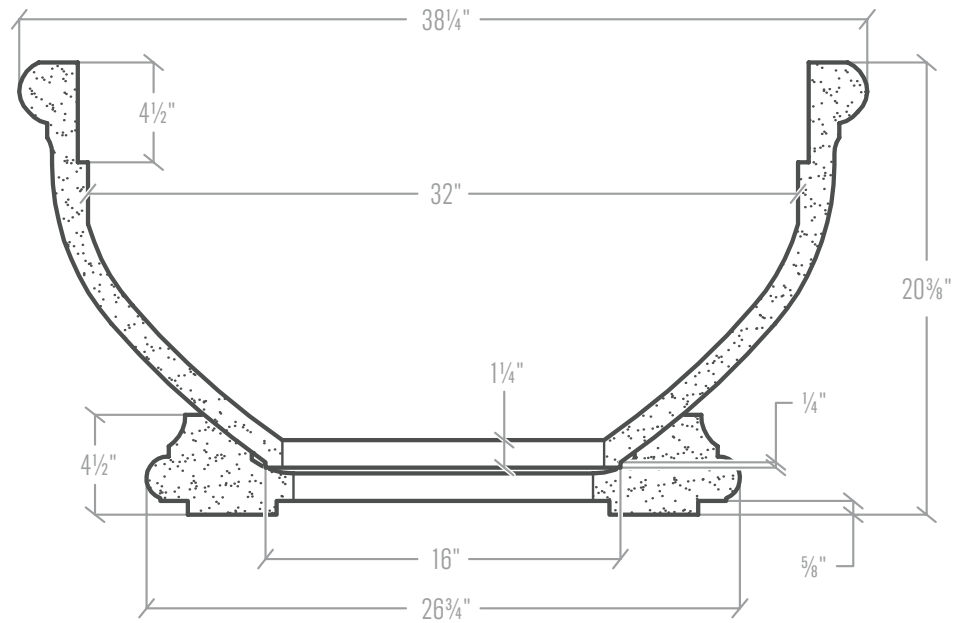



# PARTS LIST

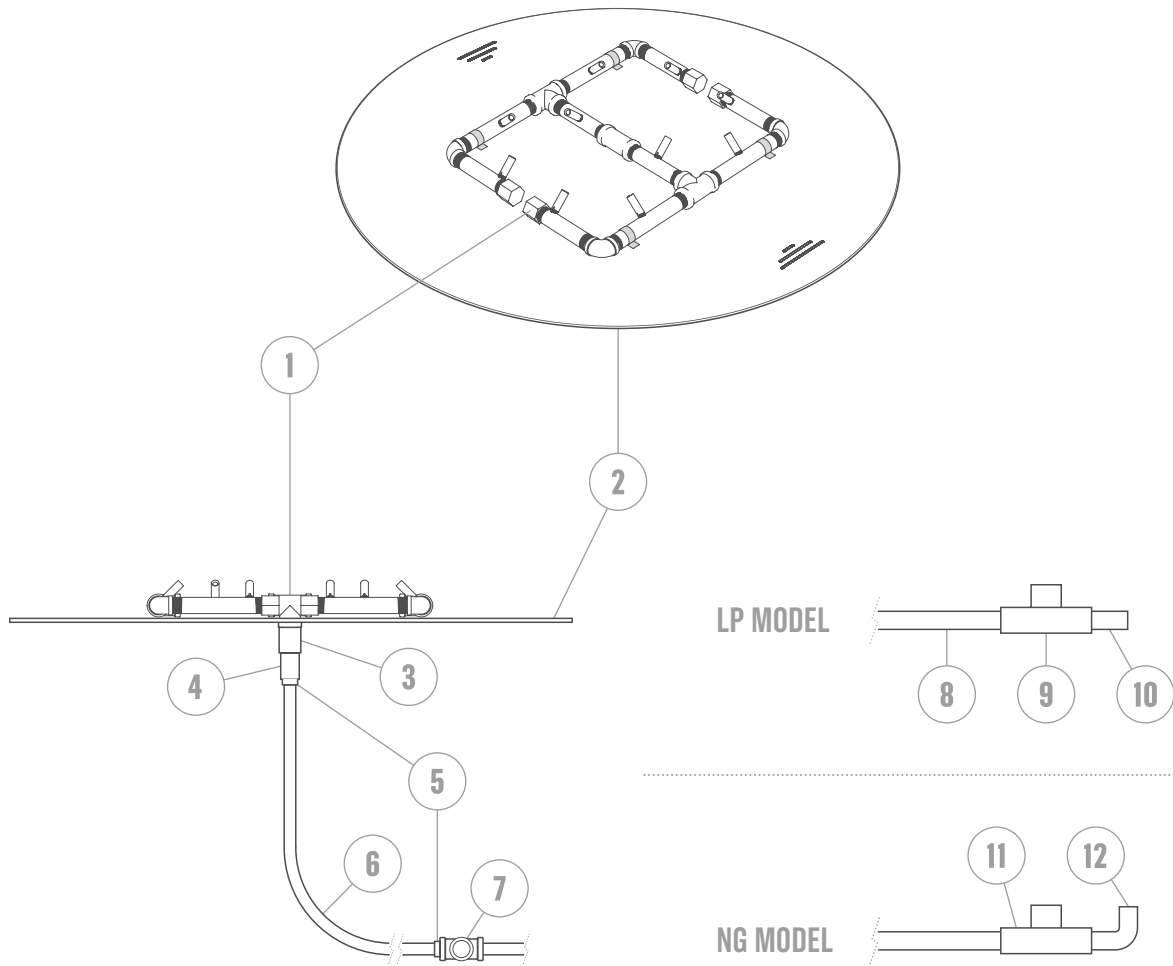

ITEM NO.	PART	QTY.
1	13" x 13" Rectangular Burner	1
2	32 3/4" Round Burner Plate	1
3	1/2" Coupling	1
4	2" Orifice Fitting	1
5	1/2" Male Flared Fitting	2
6	1/2" Flex Hose - 3' Length	1
7	Key Valve	1
—	38 1/4" Round x 20 3/8" Fire Bowl	1
—	Gas Valve Key	1

ITEM NO.	PART	QTY.
—	Lava Rock	1
—	Vinyl Cover	1
<b>LP MODEL ONLY</b>		
8	3/8" Propane Hose - 10' Length	1
9	65,000 BTU LP Regulator	1
10	1/2" Quick-Connect Fitting	1
<b>NG MODEL ONLY</b>		
11	65,000 BTU NG Regulator	1
12	Street 90	1

Patent Pending Burner Technology provided by Warming Trends™





## GAS REQUIREMENTS

Read this section before installation. It explains what you need to know about liquid propane & natural gas prior to setting up your fire bowl.

### LIQUID PROPANE

Your fire bowl is not provided with a propane tank. You will need to provide one. Use the following specifications for purchasing your propane tank.

#### SPECIFICATIONS

The 20 lb. propane gas supply cylinder is constructed and marked in accordance with the specifications for propane gas cylinders as required by the U.S. Department of Transportation (DOT), *Specifications for LP-Gas Cylinders or the Standard for Cylinders, Spheres and Tubes for Transportation of Dangerous Goods and Commission*, CAN/CSA B339, as applicable.

**Manifold Pressure:** For plumbed-in liquid propane installation, use a regulator.

**Supply Pressure:** Maximum line pressure for plumbed-in propane is 14" W.C. psi (3.5 kPa). Minimum line pressure for propane is 11" W.C.

**Pressure Regulator:** The unit must be used with the supplied gas pressure regulator and hose assembly. The regulator will control and maintain a uniform gas pressure in the manifold. The burner orifice has been sized for the gas pressure delivered by the regulator. Replacement pressure regulator and hose assemblies must be those specified in this manual.

**Cylinder Specification:** Any propane gas supply cylinder used with this fire bowl must be approximately 12" in diameter and 18" high. The maximum fuel capacity is 20 lbs. of propane, or 5 gallons. Full cylinder weight should be approximately 38 lbs. (43.7 lbs. nominal water capacity.) Always use the cylinder dust cap on the cylinder valve outlet during transport and when the cylinder is not connected to the fire bowl. The 20 lb. propane gas cylinder used must include a collar to protect the cylinder valve.

**Filler Valve:** If you do not have an updated filler valve on your existing propane tank, you will need to purchase one at your local hardware store, as you will not be allowed to refill the tank at any filling station.

**Transporting Gas Cylinder:** Only one cylinder should be transported at a time. Transport cylinder in an upright and secure manner with control valve turned off and the dust cap in place.

### NATURAL GAS

Ensure that the service supplying the fire bowl is fitted with a conveniently positioned shut off valve with easy access. The shut-off valve MUST NOT be inside the appliance!

#### REQUIREMENTS

Always check the rating plate to make sure the gas supply you are hooking up to is the gas type the fire bowl is manufactured for.

The installation of this appliance must conform with local codes or, in the absence of local codes, to the *National Fuel Gas Code*, ANSI Z223.1, NFPA 54; *National Fuel Gas Code; Natural Gas and Propane Installation Code*, CSA B149.1; or *Propane Storage and Handling Code*, CSA B146.2, as applicable. Natural gas connection must be performed by a licensed contractor or local gas company representative.

Ensure that the service supplying the fire bowl is fitted with a conveniently positioned shut off valve with easy access.

PRESSURE	NATURAL GAS	LIQUID PROPANE
Minimum	3.5" W.C.	8.0" W.C.
Nominal	7.0" W.C.	11.0" W.C.
Maximum	½ psi (14.0" W.C.)	½ psi (14.0" W.C.)

#### PRESSURE TESTING

If this fire bowl is installed with a fixed fuel piping system and equipped with an appliance gas pressure regulator, the fire bowl and its individual shut-off valve must be disconnected from the gas supply piping system during any pressure testing of the system at test pressures in excess of ½ psi (3.5 kPa).

The fire bowl must be isolated from the gas supply piping system by closing its individual manual shut-off valve during any pressure testing of the gas supply piping system at test pressures equal to or less than ½ psi (3.5 kPa).



## SET-UP

Set-up of your Kindred Outdoor fire bowl consists of 4 easy steps:

1. **Place Fire Bowl in Desired Location**
2. **Connect Gas Line**
  - 2.1 **Connection for Liquid Propane**
  - 2.2 **Connection for Natural Gas**
3. **Perform a Leak Test**
4. **Place Decorative Stone in Fire Bowl**

We require our products be installed by a professional that is locally licensed by the authority having jurisdiction in gas piping.

This appliance, when installed, must be electrically grounded in accordance with local codes or, in the absence of local codes, with the *National Electrical Code*, ANSI/NFPA 70; or the *Canadian Electrical Code*, CSA C22.1, if applicable.



### PLACE FIRE BOWL IN DESIRED LOCATION

***Kindred Outdoor fire bowls are designed for outdoor use only.***

Never locate this appliance in a building, garage or other enclosed room, under a sealed overhead structure, or in any enclosed area such as a shed or breezeway. Keep clear of trees and shrubs.

Do not place fire bowl under or near windows or vents that can be opened into your home.

Maintain sufficient distance as to not overheat any overhead combustible material such as a patio cover. The area surrounding your fire bowl should be kept clean and free from flammable liquids and other combustible materials such as mops, rags or brooms, as well as solvents, cleaning fluids, and gasoline.

Do not block the vents located near the base of your fire bowl as gas may build up in case of leak and cause serious damage.

Do not locate appliance where it can get excessively wet. Do not use this appliance if any part has been underwater. Immediately call a qualified service technician to inspect the unit and to replace any part of the control system and any gas control which has been underwater.

Place your fire bowl on a flat and stable surface in an outdoor location such as a patio deck. Maintain the following clearances to combustible materials:

- Sides & Back** ..... 48 inches (122 cm)  
*measured from side*
- Top** ..... 120 inches (305 cm)  
*measured from hearth*
- Adjustable Legs** ..... ½ inch (1.27 cm) *measured from bottom of fire bowl to flooring surface (for ventilation)*

#### VENTILATION

Fresh air must be able to pass through installed vents to safeguard against residual gas accumulation. Failure to allow proper ventilation may cause fire or explosion. Place the fire bowl on a solid platform such as concrete to allow air flow through vents in the bottom. The vents must never be allowed to be obstructed. Maintain a ½" clearance from bottom of the fire bowl to the flooring surface.

#### PLACEMENT FOR NATURAL GAS

If you are planning to use natural gas, you may choose to locate the fire bowl in a permanent location in order to hide the gas line. If you bury the gas line, you will need a gas riser about 10" above the ground. You will also need to have a gas valve located *OUTSIDE* the fire bowl in order to shut off gas to the fire bowl. We strongly recommend having a licensed contractor install your gas line.



## SET-UP Continued

### 2 CONNECT GAS LINE

#### *Location of Gas Inlet*

**THIS APPLIES TO BOTH LIQUID PROPANE & NATURAL GAS INSTALLATION.**

Your fire bowl will arrive with the burner and burner plate set in the fire bowl as shown in *Figure A*. You will need to lift it up to access the gas inlet.

The gas line between the burner and the gas valve located on the side of the fire bowl has been connected for your convenience. *Figure B* shows the burner plate lifted up with the flex hose connected to the burner.

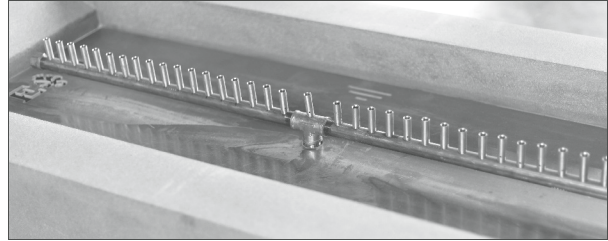

Figure A

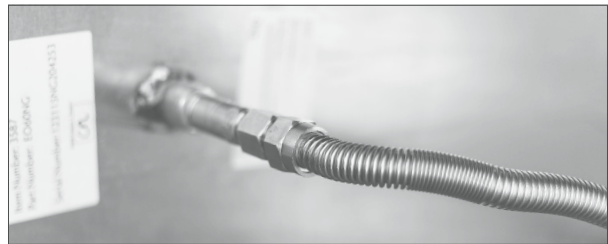

Figure B

### 2.1 CONNECTION FOR LIQUID PROPANE

Unless you have a permanent liquid propane gas line installed, you will need to bring the black gas line under the fire table through the ventilation. See *Figure C*.

The flex line that runs from the gas valve to the burner has been connected at the factory. You will only need to connect the propane line from the gas valve to the propane tank, as shown in *Figure D*.

Perform a leak test before replacing the burner plate. (See pg. 12.)

Connect the black liquid propane hose to a gas cylinder. Use a QCC-1 propane connector with a regulator. (See page 9 for description.)

When you connect the regulator to the tank valve, hand tighten the black QCC-1 nut clockwise. **DO NOT** use a wrench to tighten.

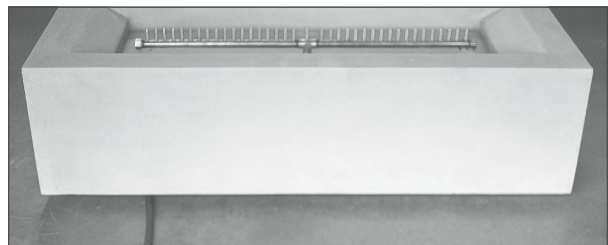

Figure C

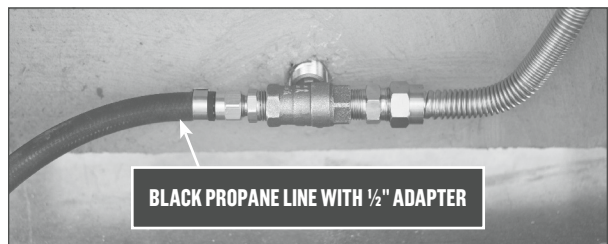

Figure D

**BLACK PROPANE LINE WITH 1/2" ADAPTER**



## SET-UP Continued

### 2.2 CONNECTION FOR NATURAL GAS

The flex line that runs from the gas valve to the burner has been connected at the factory. You will only need to connect the natural gas line from the gas valve to the gas source, as shown in the *Figure E*.

Perform a leak test before you replace the burner plate. (*See below.*)  
Connect to the gas source.

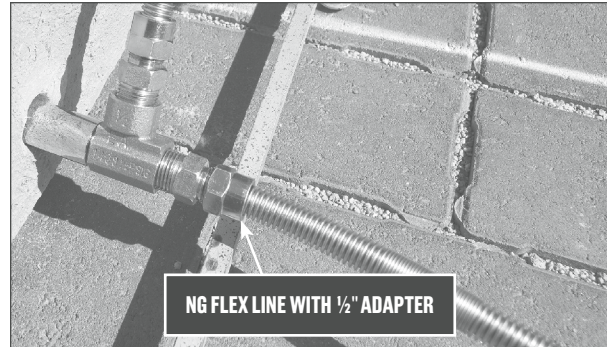

Figure E

### 3 PERFORM A LEAK TEST

Perform a leak test at least once a year whether the gas supply cylinder has been disconnected or not. In addition, whenever the gas cylinder is connected to the regulator or whenever any part of the gas system is disconnected or replaced, perform a leak test.

As a safety precaution, remember to always leak test your fire table outdoors in a well-ventilated area. Never smoke or permit sources of ignition in the area while doing a leak test. Do not use a flame, such as a lighted match to test for leaks. Use a solution of soapy water.

1. Prepare a leak testing solution of soapy water by mixing in a spray bottle one part liquid soap to one part water.
2. Make sure all the control knobs are in the **OFF** position.
3. Turn on the gas.
4. Apply the leak-testing solution by spraying it on joints of the gas delivery system. Blowing bubbles in the soap solution indicates that a leak is present.

5. Stop a leak by tightening the loose joint or by replacing the faulty part with a replacement part recommended by the manufacturer. Do not attempt to repair the cylinder valve if it is damaged. The cylinder must be replaced.
6. Turn the control knob back to the full **OFF** position.

If you are unable to stop a leak:

7. Turn the control knob back to the full **OFF** position.
8. Shut off the gas supply to the fire table and release pressure in the hose and manifold.
9. On propane systems, remove the cylinder from the fire table.
10. Call an authorized gas appliance service technician or an liquid propane gas dealer.

Do not use the appliance until the leak is corrected.



## SET-UP Continued

### **4** PLACE DECORATIVE STONE IN FIRE BOWL

After you have completed all the plumbing installation, you can fill the fire bowl with the decorative filler material provided.

The type of filler placement, such as lava rock, decorative stone or glass, is entirely your choice according to your preferences, but it needs to be rated for use with fire. Decorative filler material cannot be smaller than ½" in diameter. You can place the filler material on the burner, but no higher than 1" thick. Excessive filler material may impede gas flow and cause gas build-up and potentially cause an explosion.





## OPERATING THE FIRE BOWL

**WARNING: DO NOT use solid fuel, such as wood or charcoal, in gas fueled fire bowls.**

Upon completing the gas line connection, a small amount of air will be in the lines. When the first lighting the burner, it will take a few seconds for the lines to purge themselves of this air.

Once the purging is complete, the burner will light and operate as indicated in the instruction manual. Subsequent lighting of the appliance will not require purging unless the gas supply has been disconnected.

Inspect the gas hose before each use of the fire bowl. If the hose shows evidence of excessive abrasion or wear or if the hose is damaged, it must be replaced before using the fire bowl.

Inspect the burner before each use of the appliance. If there is any evidence that the burner is damaged, it must be replaced before operating. Upon completing the gas line connection, a small amount of air will be in the lines. When first lighting the burner, it will take a few minutes for the lines to purge themselves of this air. Subsequent lighting of the appliance will not require such purging.

Never allow the ON/OFF valve to remain in the open position without placing a burning match on top of the burner **FIRST!**

You must have clear and easy access to the ON/OFF valve **AFTER** the appliance is installed and connected to the gas supply in order to safely turn of the burner.

Make sure the burner is in place prior to using the appliance. If the burner is damaged, install a replacement burner as specified by the manufacturer.

### FOR YOUR SAFETY, READ BEFORE LIGHTING

- Before operating the fire bowl, smell around the appliance area for gas odors. Be sure to smell the surrounding floor area as some gases are heavier than air and will settle on the ground.
- Use only your hand to turn the manual gas control valve. Never use tools. If the valve will not turn by hand, do not try to repair it. Call a qualified service technician. Force or attempted repair may result in a fire or explosion.

### LIGHTING INSTRUCTIONS

1. Turn the ON/OFF valve located on the side of fire bowl completely to the **ON** position.
2. Make sure fuel supply (LP or NG) is properly connected and turned on at the source. This will be either the LP tank or the NG valve.
3. When you hear gas flowing, use either a long stem wooden match or a butane fireplace lighter to place a flame near the burner.
4. If the burner does not light, does not stay lit, or the flame is very low, shut off the gas supply and wait five minutes to allow all fumes to clear. Start again from Step 1, making sure all gas valves are completely opened.

### TURNING OFF GAS

**For NG Units:** Turn the ON/OFF valve to the **OFF** position at the unit for natural gas unit, then close the valve at the NG source.

**For Propane Units:** Turn the ON/OFF valve to the **OFF** position at the unit and then close the valve on the propane tank.

### NOTE

The propane regulator in this appliance is equipped with a low flow protection device. Unless the propane cylinder valve is opened before the valve, the gas flow will be reduced resulting in a very small flame.

To reset this device, shut off the valve, disconnect the hose from the cylinder to relieve the pressure, then close the propane cylinder valve.



## TROUBLE SHOOTING

PROBLEM	POSSIBLE CAUSES	REMEDY
Will not light	Air in gas line	If new install, may take several attempts to purge air
	Debris in gas line	Confirm gas line is clear (insulation, dirt, plastic, excessive pipe sealer, etc.)
	Improper gas pressure	Confirm proper gas pressure
Will not stay lit	Improper gas pressure	Confirm proper gas pressure
	Improperly applied media	Review media application
Noise <i>Note: The movement and combustion of gas will create low, unavoidable levels of noise.</i>	Passage of air/gas across irregular surfaces	Remove any tight bends or kinks in gas supply line
	Excessive gas pressure on natural gas units	Check or reset gas regulator pressure
Unit is smoking/sooting excessively <i>Note: It is natural and unavoidable for appliance sets to produce moderate levels of carbon (soot) where flames contact the media</i>	Poor fuel quality	Contact local natural gas company
	Excessive flame impingement or blockage	Separate the media to allow more flame passage
	Improper fuel and/or air mixture	Remove any foreign items from the flame pattern and check for proper orifice sizing
Burner flame is too low or too high	Incorrect gas supply or pressure	Check for proper gas supply pressure
	Blocked burner orifice or burner ports	Free burner orifice and burner ports of any debris or blockage
	Improper burner orifice size	Verify proper burner orifice sizing
Unit produces unwanted odors	Gas leak, see <i>Warning Statement</i>	Check for and seal all gas leaks



## CLEANING, MAINTENANCE & STORAGE

### CLEANING

Inspect the appliance before initial use. Clean the appliance at least annually and have it inspected by a qualified field service person.

Periodically examine the burner. If the burner is dirty, clean it with a soft wire brush. Also examine the area around the burner air shutter. Remove any dirt or debris in this area. This will ensure long life and trouble-free operation.

The easiest way to clean the fire bowl burner is to let it cool completely off and spray the enclosure off with water. DO NOT spray water directly onto the burner.

For routine cleaning of the fire bowl, wipe down with a damp cloth or sponge. Avoid using any cleaners as they may contain chemicals or color that could cause discoloration. To remove stains, use a Marble or Granite stain remover available at any home improvement store.

When not in use and after cooling, cover your fire bowl with a full length cover. The cover will help protect your fire bowl from detrimental effects of weather and environmental pollutants.

Before placing the cover on the fire bowl, make sure the unit is shut off, the gas lines are disconnected and that the unit has had sufficient time to cool. Install the cover and use the tie-down straps to secure it tightly to the unit to prevent wind from blowing it off.

More frequent cleaning may be required as necessary. It is imperative the control compartment, burner and circulation air passageways of the appliance be kept clean and free.

### MAINTENANCE

Periodically check the hose connecting the propane gas cylinder to ensure it is not cracked or damaged in any way. All natural gas hook-ups should be serviced and inspected only by qualified installers only.

Spiders and insects can nest in the burners and block the gas and airflow to the burner ports. This creates a dangerous condition that can result in a fire from behind the valve panel. Inspect and clean the burners periodically.

Any guard or other protective device removed for servicing must be replaced prior to operating the appliance.

If it is evident there is excessive abrasion or wear of any of the components, if the fuel supply hose is cut or cracked, it must be replaced prior to the appliance being put into operation.

Inspect the fuel supply connection for signs of leakage (including the hose for propane models) before each use of the appliance.

Do not repair or replace any part of your fire bowl. Have a qualified technician perform all service. Any repairs made by a non-approved service technician will void your warranty.

### STORAGE

When your fire bowl is not in use, turn off the gas at the source.

This appliance can be store indoors only if it has been disconnected from its fuel supply.

Store propane cylinders outdoors in a well-ventilated area out of reach of children. Disconnected cylinders must have threaded valve plugs tightly installed and must not be stored in a building, garage, or any other enclosed area.

To extend the life of your fire bowl, protect and cover it from the elements when not in use. Ensure the appliance has ample time to cool off after use and prior to installing storage cover. Damage caused to storage cover due to heat or burns are not covered by warranty.





## WARRANTY

This product is warranted to be free from defects in material and workmanship for one year from the date of purchase.

If a part proves to be defective under normal use, the part will be repaired or replaced. Our obligation under this warranty is to repair or replace defective parts at our discretion. If we determine that repair of a covered item is not feasible, we reserve the right to replace the defective merchandise with merchandise equal in value to the original purchase price. Warranty repair or replacement are the sole discretion of **Westlake Royal LLC**, and this warranty does not cover costs therein, including but not limited to: freight, removal, re-installation, etc.

There will be no charge for parts on a covered item, however, cost of labor is the responsibility of the owner. Shipping and handling charges will apply to all warranted replacement parts. The service agent may assess a reasonable travel or mileage charge per service call.

This limited warranty applies only to fire bowls normally used for personal, family, or household purposes and specifically excludes rental or commercial applications.

This warranty is non-transferable.

Decorative stones and decorative glass are not covered by this warranty.

This warranty is void if the fire bowl has been subject to negligence, alteration, misuse, repairs, dings, dents, scratches, or incorrect and/or prohibited applications as specified in the owner's manual.

Natural gas lines must be installed by a licensed plumber only or local gas company agent.

The original purchaser acknowledges and agrees that this product is a handmade, hand-finished product. Each piece is unique. Any samples provided are typical of texture, finish, individual characteristics, and color but they should not be considered exact representations of the final product. There can be up to a 15% variation in color and texture from piece to piece. In addition, shape detail can vary as much as 1/4" in size. The texture created by entrapped air ranges from smooth to randomly indented. Minor chipping, water staining, and non-structural hairline cracks are also traditional characteristics of this product. As with natural stone, color will vary on individual orders and among individual pieces in the same order. As with natural stone, excessive heat exposure may cause discoloration. As fire bowls age, color may lighten or darken according to specific field or storage conditions such as humidity, temperature, and exposure to sunlight.



KINDRED

OUTDOORS + SURROUNDS