



SELECT DESIRED GAS:

- NATURAL GAS
- PROPANE

SELECT DESIRED FINISH:

- 304 STAINLESS STEEL
- BLACK POWDER COAT
- CUSTOM POWDER COAT SPECIFY: _____

OPTIONAL GAS CONNECTION COVER

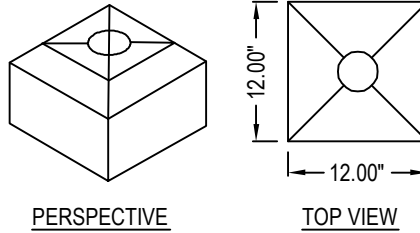

PERSPECTIVE

TOP VIEW

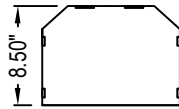

FRONT AND SIDE ELEVATION

HEAT COVERAGE

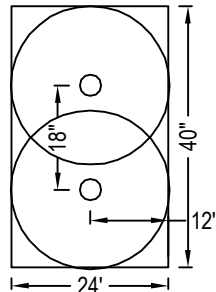

TYPICAL COVERAGE TWO HEATERS

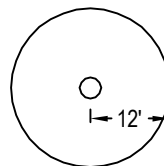

TYPICAL COVERAGE ONE HEATER

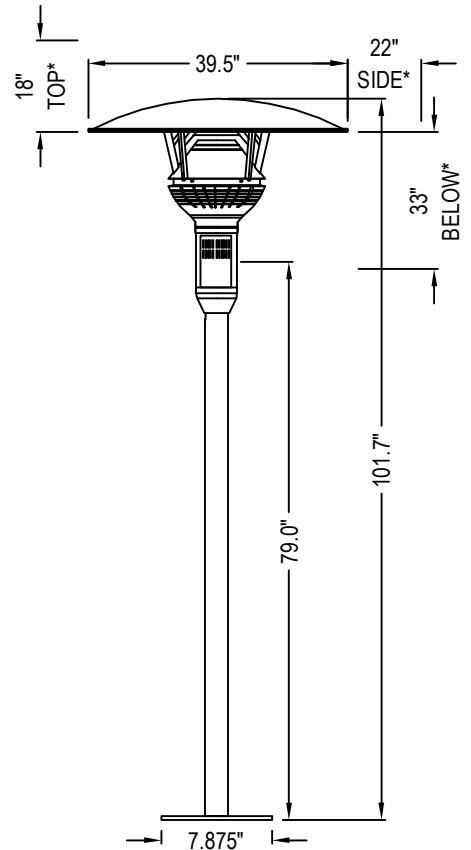

FRONT ELEVATION - MODEL GA301-T

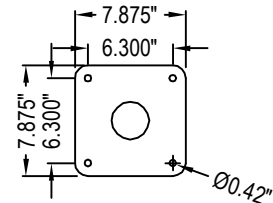

BOTTOM MOUNTING PLATE

TECHNICAL SPECIFICATIONS:

- HIGH FIRE - 53,000BTU/HR (NG)
47,000BTU/HR (LPG)
- LOW FIRE - 46,000BTU/HR (NG)
40,000BTU/HR (LPG)
- MANIFOLD PRESSURE: NG -
5.5" W.C. (HI), 4.0" W.C. (LO) | LPG -
9.8" W.C. (HI), 7.0" W.C. (LO)
- GAS SUPPLY PRESSURE: NG -
6.5" W.C. (MIN), 14.0" W.C. (MAX) |
LPG: 11.0" W.C. (MIN), 14.0" W.C. (MAX)
- ELECTRICAL SUPPLY: 24 VOLTS, 0.8 AMPS
- DIRECT SPARK IGNITION WITH 3-TRY LOCK OUT & AUTOMATIC RE-LIGHT

WARRANTY:

- 3 YEARS ON 316 STAINLESS STEEL EMITTER
- 1 YEAR ON ALL OTHER PARTS

NOTES:

1. INSTALLATION TO BE COMPLETED IN ACCORDANCE WITH MANUFACTURER'S SPECIFICATIONS.
2. DO NOT SCALE DRAWING.
3. THIS DRAWING IS INTENDED FOR USE BY ARCHITECTS, ENGINEERS, CONTRACTORS, CONSULTANTS AND DESIGN PROFESSIONALS FOR PLANNING PURPOSES ONLY. THIS DRAWING MAY NOT BE USED FOR CONSTRUCTION.
4. ALL INFORMATION CONTAINED HEREIN WAS CURRENT AT THE TIME OF DEVELOPMENT BUT MUST BE REVIEWED AND APPROVED BY THE PRODUCT MANUFACTURER TO BE CONSIDERED ACCURATE.
5. CONTRACTOR'S NOTE: FOR PRODUCT AND COMPANY INFORMATION VISIT www.CADdetails.com/info AND ENTER REFERENCE NUMBER 5029-014.

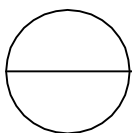

EVENGLO

EVENGLO FIXED SERIES: MODEL GA301T