

Flaming Ember Burner



General Assembly, Installation, and Operation Instructions.

If using the "EASY" Safety Pilot System consult separately attached instructions.

Register Your Purchase at www.rasmussen.biz.



Rasmussen[®]
THE GAS LOG COMPANY

12028 E. PHILADELPHIA ST.
WHITTIER, CA 90601 U.S.A.
www.rasmussen.biz

REV: FEB 0410
Last Printed: 4/27/2010 3:42 PM

ATTENTION! READ INSTRUCTIONS CAREFULLY BEFORE ASSEMBLY OR USE

For use with Vented Hearth Kits, Natural Gas Burners; F, FH, FX, FXH, or Propane Gas Burners; FA, FAH, FAX, FAXH

WARNING: If the information in this manual is not followed exactly, a fire or explosion may result causing property damage, personal injury or loss of life.

- Do not store or use gasoline or other flammable vapors and liquids in the vicinity of this or any other appliance.
- **WHAT TO DO IF YOU SMELL GAS**
 - Do not try to light any appliance.
 - Do not touch any electrical switch; do not use any phone in your building.
 - Immediately call your gas supplier from a neighbor's phone. Follow the gas supplier's instructions.
 - If you cannot reach your gas supplier, call the fire department.
- Installation and service must be performed by a qualified installer, service agency or the gas supplier.

INSTALLER: Leave this manual with the appliance.
CONSUMER: Retain this manual for future reference.

Improper installation, alteration, service or maintenance can cause property damage, personal injury or loss of life. Read these instructions thoroughly before installation. For assistance or additional information, consult your gas log dealer, qualified installer, service agency or gas supplier.

This appliance may be installed in an aftermarket, permanently located, manufactured (mobile) home, where not prohibited by local codes.

This appliance is only for use with type of gas indicated on the rating plate.

Installation must conform with local codes or, in the absence of local codes, with the National Fuel Gas Code, ANSI Z223.1/NFPA 54.

In the Commonwealth of Massachusetts:

- Installation must be performed by a licensed plumber or gas fitter.
- The chimney flue damper, when used with gas logs, will be welded open or completely removed.
- A CO detector shall be installed in the room where the appliance is installed.

IMPORTANT INFORMATION

This burner and gas log set are for use in a fully functioning wood burning fireplace with the **DAMPER WIDE OPEN**, it must be installed in a **FULLY VENTED** solid-fuel burning fireplace with a working flue constructed of non combustible material. The **FLUE MUST VENT ALL PRODUCTS OF COMBUSTION**.

CARBON MONOXIDE POISONING MAY LEAD TO DEATH

When used without fresh air, decorative gas appliances may give off carbon monoxide, an odorless, colorless, poisonous gas. Some people, pregnant women, persons with heart or lung disease, anemia, persons under the influence of alcohol and persons who live at high altitudes are more affected by carbon monoxide than others.

Early signs of carbon monoxide poisoning resemble the flu and include; headache, dizziness and/or nausea. If you have these symptoms, the burner or the appliance may not be installed or working properly, or the flue may be blocked. **GET FRESH AIR AT ONCE!** Verify that the gas log set is properly arranged and have the heater and chimney flue serviced before using again.

WARNING:

A SAFETY PILOT MUST BE INSTALLED ON ALL UNITS DESIGNED OR CONVERTED TO BURN PROPANE GAS

Compliant with The Department of Building and Safety, Rule of General Application No. RGA2-72, "Standard for decorative Log Sets for Installation in Wood Burning Fireplaces" Decorative Gas Appliances for Installation in Solid-Fuel Burning fireplaces.

The installation and the provisions for combustion and ventilation air must conform with *The National Fuel Gas Code ANSI Z223.1 / NFPA54*, or *The CSA B149.1, Natural Gas and Propane Installation Code*, latest edition.

IMPORTANT INFORMATION

- **Due to high temperatures**, the appliance should be located out of traffic and away from furniture and draperies.
- **Children and adults** should be alerted to the hazard of high surface temperatures and should stay away to avoid burns or clothing ignition.
- **Young children** should be carefully supervised when they are in the same room with the appliance.
- **Do not place** clothing or other flammable material on or near the appliance.
- **Any safety screen** or guard removed for servicing an appliance must be replaced prior to operating the appliance.
- **Installation and repair** should be done by a qualified service person. The appliance should be inspected before use and at least annually by a professional service person. More frequent cleaning may be required due to excessive lint from carpeting, bedding material etc. It is imperative that control compartments, burners and circulating air passageways of the appliance be kept clean.
- **WARNING:** Any change to this appliance or its controls can be dangerous.
- **WARNING:** Failure to keep the primary air opening(s) of the burner clean may result in sooting and property damage.
- **Keep appliance area** clear and free from combustible materials, gasoline and other flammable vapors and liquids.
- **DO NOT** use this room appliance if any part has been under water. Immediately call a qualified service technician to inspect the appliance and to replace any part of the control system and any gas control that has been under water.
- **WARNING:** Before installing in a solid-fuel burning fireplace, the chimney flue and firebox must be cleaned of soot, creosote, ashes and loose paint by a qualified chimney cleaner.
- **WARNING:** Do not allow fans to blow directly into the fireplace. Avoid any drafts that alter burner flame patterns.
- **WARNING:** Do not use a blower insert, heat exchanger insert or any other accessory not approved for use with this heater.
- **A fireplace screen** must be in place when the appliance is operating and, unless other provisions for combustion air are provided, the screen shall have an opening(s) for introduction of combustion air.
- **Solid fuels** shall not be burned in a fireplace where this appliance is installed.
- **WARNING:** Glass doors must be fully opened when appliance is in operation to allow for safe combustion, cooling of components and venting.
- **Any outside air ducts** and/or ash dumps in the fireplace shall be permanently closed at the time of appliance installation.
- This appliance may be used in bedrooms and bathrooms if used in a vented application, subject to local codes.
- **Avoid contact** with the objects, chassis or another part which may be hot during operation.

This product is designed to be an ATTENDED appliance. Do not leave this unit burning while unattended or while anyone is sleeping. Young children MUST be supervised when in the same room with the appliance and are NOT to operate this unit.

WARNING! CHECK FOR PROPER VENTING

A properly sized, unobstructed chimney will normally vent all products of combustion. Any odor or smoke detected inside the room is an indication that the flue is not functioning properly.

SHUT OFF THE BURNER IMMEDIATELY! THE CAUSE OF THE VENTING PROBLEM MUST BE DISCOVERED AND CORRECTED BEFORE CONTINUED USE OF THE GAS LOG SET.

Continued use with improper venting may cause damage to your fireplace, room furnishings and could cause serious illness. **IF IMPROPER VENTING IS SUSPECTED, IMMEDIATELY HAVE BURNER AND CHIMNEY FLUE SERVICED. ALSO, VERIFY THAT LOG SET IS INSTALLED PER THESE INSTRUCTIONS.**

MINIMUM AND MAXIMUM INLET GAS SUPPLY PRESSURES

The minimum inlet gas supply pressure shall be 6 inches of water column on Natural Gas and 11 inches of water column on Propane. The maximum inlet gas supply pressure shall be 7 inches of water column on Natural Gas and 14 inches of water column on Propane. The appliance and its main gas valve must be disconnected from the gas supply piping system during pressure testing of that system at test pressures in excess of 1/2 psi (3.5 kPa). The appliance must be isolated from the gas piping system by closing its equipment shutoff valve during any pressure testing of the gas supply piping system at test pressures equal to or less than 1/2 psi (3.5 kPa).

WARNING—Proposition 65 Statement

If not installed, operated and maintained in accordance with these instructions, this product could expose you to substances in fuel or from fuel combustion which are known to the State of California to cause cancer, birth defects or other reproductive harm.

PARTS LIST

(Parts not shown to scale)

All Flaming Ember Burners will include the parts listed below except where otherwise noted. The quantity and/or size of parts and supplies shown will vary with each style burner and control.

REQUIRED TOOLS AND MATERIALS

Adjustable Wrench, Pipe Wrench and Pipe Sealing compound (required if fittings not already pre-wrapped with Teflon thread tape). Consult individually supplied instructions for assembly and/or parts not listed below.

- | | | |
|-------------------------------------------------------------------------------------------------------------------------------------------------------------------------------------------------------------------------------------------------------------------------------------------------------------------------------------------------------------------------|-----------------------------------------------------------------------------------------------------------------------------------------------------------------------------------------------------------------------------------------------------------------------------------------------------------------------------------------------------------------------------------------------|-----------------------------------------------------------------------------------------------------------------------------------------------------------------------------------------------------------------------------------------------------------------------------------------------------------------------------------------------------------------------------------------------------|
| <ol style="list-style-type: none"> 1. Grate (HFG15-48) 2. Burner Pan (FX shown) 3. Rating/I.D. Plate 4. Orifice Spud (01-XX) 5. Burner Plug 6. Damper Clamp (DC1) 7. 3/8" x 1/2" FIP Flared Brass Fitting (A1) 8. Orifice Holder (Internally Tapped 3/8" x 3/8" Flared MIP Fitting) (A2T) | <ol style="list-style-type: none"> 9. Air Mixer for Propane Gas burners (MA2) 10. Valve Knob Extender for Manual "EASY" Safety Valve (STV-10) 11. Log Lifters (LL) 12. Flex Connector (SSCB-14) 13. White Silica Sand (SS8) (Natural Gas Sets) 14. Ember Magic (EMX1) 15. Black Volcanic Ash (VA5) (Propane Sets) | <ol style="list-style-type: none"> 16. Optional -SPK3E, -RPK3E and -RMC1E models come pre-assembled with "Easy" Safety Control. The "Easy" Safety Control is required for Propane sets and may be purchased separately as an upgrade kit. 17. Optional V17B Manual Valve Kit
A) 3/8" MIP x 3/8" MIP Valve (V17)
B) 3/8" x 3/8" Street Elbow
C) 9" long Key (K5) |
|-------------------------------------------------------------------------------------------------------------------------------------------------------------------------------------------------------------------------------------------------------------------------------------------------------------------------------------------------------------------------|-----------------------------------------------------------------------------------------------------------------------------------------------------------------------------------------------------------------------------------------------------------------------------------------------------------------------------------------------------------------------------------------------|-----------------------------------------------------------------------------------------------------------------------------------------------------------------------------------------------------------------------------------------------------------------------------------------------------------------------------------------------------------------------------------------------------|

18. All **Propane** Burners require an "EASY" Safety Pilot Kit, shown below. Optional for Natural Gas. A) SPK3E (Manual "EASY" Control), B) RPK3E (Remote Ready "EASY" Control), C) RMC1E (Variable Flame Height "EASY" Control)

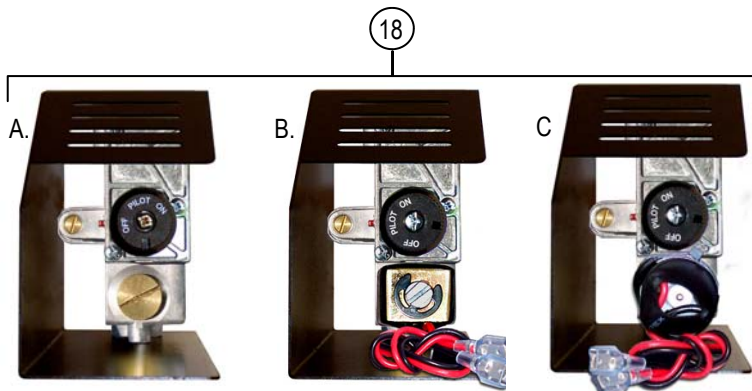

TABLE OF CONTENTS

Preparation.....	Page 4
Positioning Burner Pan and Grate.....	Page 5
Assembly and Gas Supply Connection	
• Standard Match Lighted Models.....	Page 6
• Optional Accessory Match Lighted with Manual V17 Valve.....	Page 7
• "EASY" Safety Pilot Kits.....	Page 9
Pan Medium Installation • Natural Gas.....	Page 10
• Propane.....	Page 11
Log Placement.....	Page 13
Lighting and Operation.....	Page 14
Maintenance and Troubleshooting.....	Page 15
Warranty.....	Page 16

GENERAL INSTALLATION INSTRUCTIONS

WARNING: Failure to position the parts in accordance with these diagrams or failure to use only parts specifically approved with this appliance may result in property damage or personal injury.

MINIMUM FIREPLACE REQUIREMENTS

The Minimum permanent chimney or damper opening is the minimum permanent free opening required by Standards or Codes to ensure safe operation of the appliance and must be at least 39 square inches for 18"-20" models, 51 square inches on 24" models and 64" on 30" models based on a minimum chimney height of 10 feet. It is **NOT** the minimum operating damper position.

Log Set Size	Opening Height	Firebox Depth	Front Firebox Width	Rear Firebox Width	Chimney Diameter	Min. Permanent Chimney Opening	Btu/Hour Natural Gas	Max. Input Propane Gas
18"	16"	13"	24"	18"	7"	39 Sq in.	43,000	27,000
20"	16"	13"	26"	20"	7"	39 Sq in.	56,000	35,000
24"	16"	13"	30"	24"	7"	51 Sq in.	72,000	37,000
30"	16"	13"	36"	30"	8"	64 Sq in.	75,000	50,000

(Residents of the Commonwealth of Massachusetts please consult note on page 1 regarding installation before continuing.)

STEP ONE PREPARATION:

1. Verify that the Valve Assembly is correctly matched to the log set, burner, and gas supply.
2. Turn off **Fireplace Gas Supply** (Figure 1A).
3. Thoroughly clean fireplace floor of any ashes and have a qualified chimney cleaner insure that the chimney flue and firebox are free of soot, creosote, and loose paint.
4. Attach **Damper Clamp** (Figure 2A) over edge of fireplace **Damper Blade** (Figure 2B) to prevent damper from closing accidentally. If unable to attach damper clamp, drill a hole (or holes) in the damper or remove it completely.

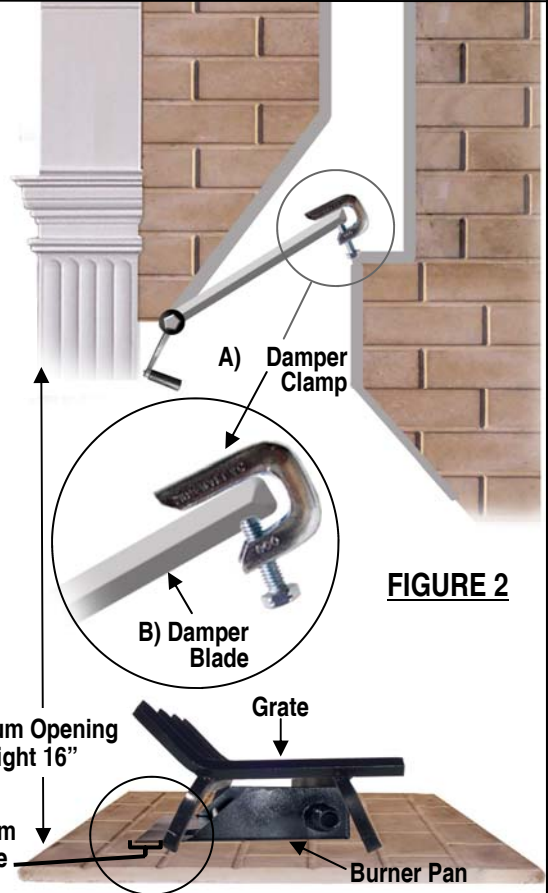
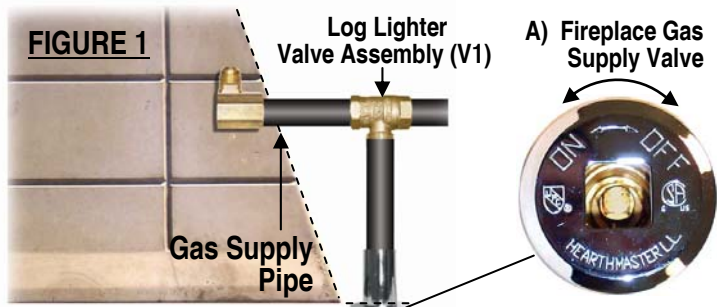

IMPORTANT GUIDELINES

- The chimney damper must be wide open and fixed in a manner to maintain a permanent free opening at all times as outlined above.
- The area of the flue must be not less than 1/10 the area of the fireplace opening.
- This gas log set must be installed in fully *VENTED* metal or masonry fireplace with a working flue that is safe for burning a wood fire.
- The flue must be free of any obstructions and must exhaust all products of combustion.
- At least 12" of noncombustible or heat resistant material is required above the fireplace. A fireplace hood will be required to act as a heat deflector in protecting combustible fireplace surrounds (facing and/or mantel) if certain minimum clearances cannot be met.
- Be certain that combustible flooring material (i.e. carpet, tile etc.) is not too close to this gas appliance. If this appliance is at floor level or less than 6" above the floor, there must be at least 12" of noncombustible material between the base of the fireplace and any combustible flooring.
- Input ratings shown in BTU per hour are for elevations up to 2,000 ft. For elevations above 2,000 ft. refer to the National Fuel Gas Code, or visit www.nfpa.org.
- The Gas appliance and it's main gas valve must be disconnected from the gas supply piping system during any pressure testing of that system as required by NFPA 54.

STEP TWO: POSITIONING BURNER PAN AND GRATE

WARNING: Failure to position the parts in accordance with these diagrams or failure to use only parts specifically approved with this heater may result in property damage or personal injury.

1. Place **Grate** inside the firebox, centered from left to right, 0" to 2" of rear wall, as depth permits (Figure 3B).
2. Place **Burner Pan** beneath grate with open edge facing out approximately one inch forward of front legs of grate. (Figure 2 and 3C) Mark positions of Grate and Burner Pan on fireplace floor with pencil then remove from the firebox (Figure 3D).

FIGURE 3

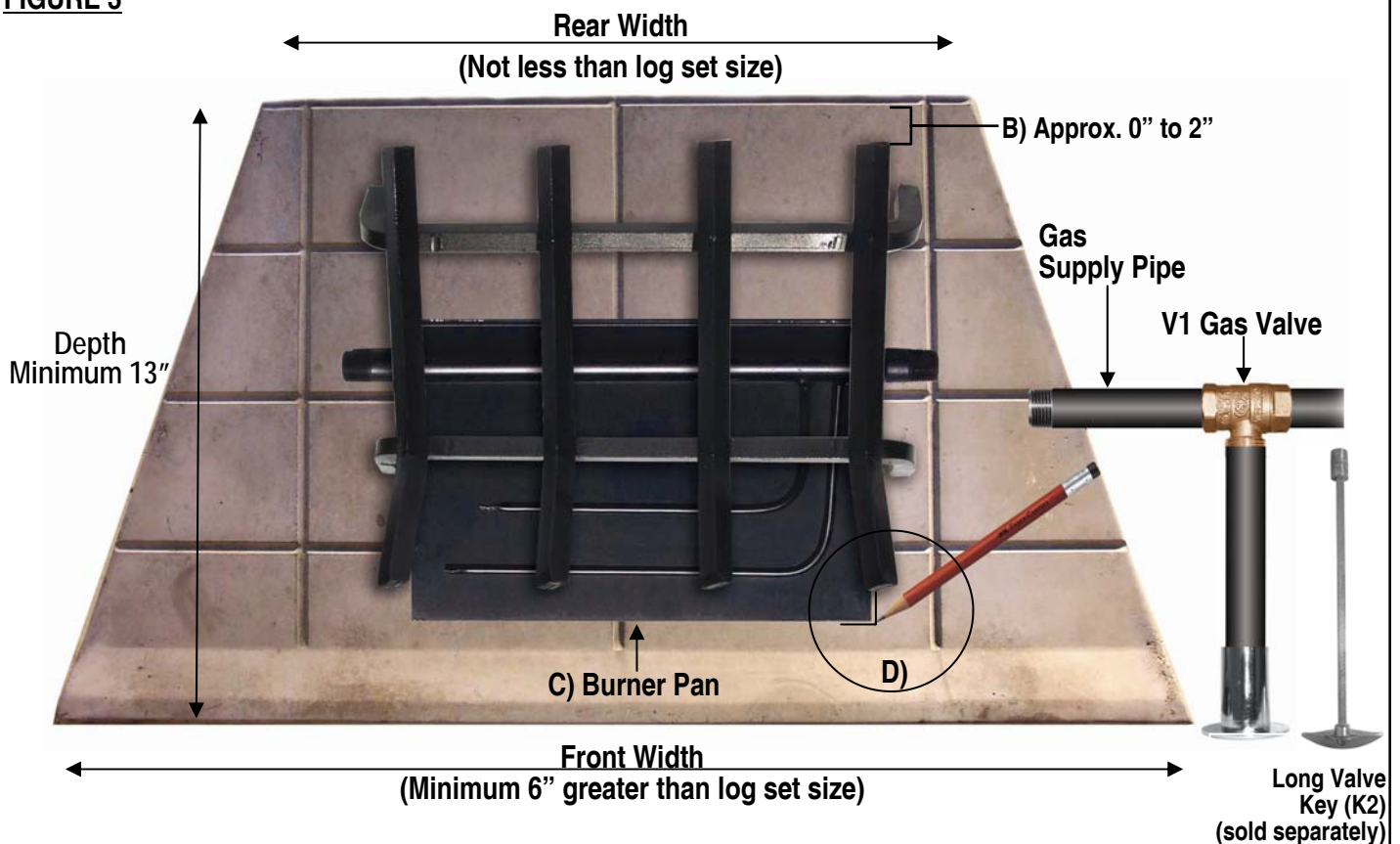

LEAK TEST PROCEDURES

WARNING: DO NOT use an open flame to test leaks!

Create a mixture of equal parts soap and water. Apply to all the joints of the pipe fittings from the gas supply to the burner. Turn on the gas supply valve for no longer than 3-5 seconds. If bubbles appear in the soap solution applied to the joints, there is a leak. Turn off the gas supply valve and tighten those fittings. Repeat the procedure until bubbles no longer appear. Remember to test all joints.

NOTE: Always perform a leak test any time the appliance has been moved or disconnected from the gas supply line.

WARNING! CHECK FOR PROPER VENTING

A properly sized, unobstructed chimney will normally vent all products of combustion. Any odor or smoke detected inside the room is an indication that the flue is not functioning properly.

SHUT OFF THE BURNER IMMEDIATELY! THE CAUSE OF THE VENTING PROBLEM MUST BE DISCOVERED AND CORRECTED BEFORE CONTINUED USE OF THE GAS LOG SET.

Continued use with improper venting may cause damage to your fireplace, room furnishings and could cause serious illness. **IF IMPROPER VENTING IS SUSPECTED, IMMEDIATELY HAVE BURNER AND CHIMNEY FLUE SERVICED. ALSO, VERIFY THAT LOG SET IS INSTALLED PER THESE INSTRUCTIONS.**

STANDARD MATCH LIGHTED (NATURAL GAS MODELS ONLY)

STEP THREE: BURNER PAN ASSEMBLY

Natural Gas Models; F, FH, FX and FXH (All other Models refer to supplied instructions)

NOTE: If fittings do not come pre-wrapped with Teflon threaded tape, pipe compound **MUST** be applied to all tapered pipe threads (except in #3 of Step 3) to prevent gas leaks. **DO NOT** use Teflon tape or pipe compound on *any* flared fitting threads.

1. Thread **Burner Plug** (Figure 4A.) into the **Burner Pipe** (Figure 4B) at opposite end of gas supply and wrench tighten.
2. Thread **Orifice Spud** (Figure 4C) into **3/8" Orifice Holder** (Figure 4D) (Do not use pipe compound or Teflon tape here)
NOTE: The Orifice Spud is a gas consumption limiter. Higher flames (and greater gas consumption) may result if orifice spud is not installed.
3. Thread Orifice Holder into Burner Pipe and wrench tighten with the flared end facing rear wall of firebox (Figure 4E).
4. Insert **Rating Plate/Heat Shield** (Figure 4F) onto the threads of and the Burner Pipe with labels facing away from the burner.

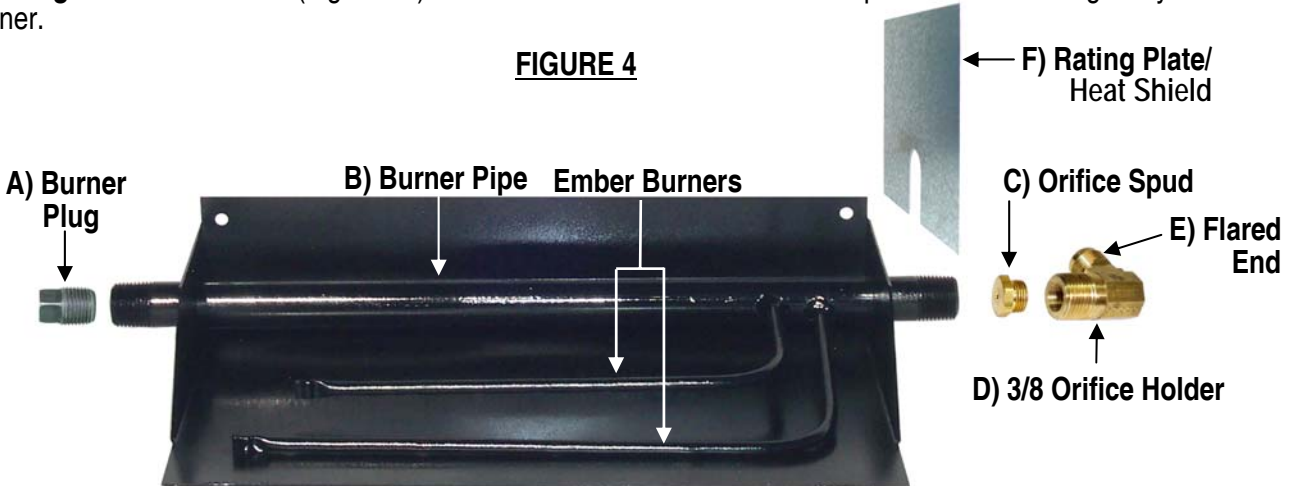

STEP FOUR: GAS SUPPLY CONNECTION

(NOTE: ENSURE THAT GAS SUPPLY TO FIREPLACE IS OFF)

1. Thread **1/2" FIP x 3/8" Flared Elbow** (Figures 5 and 6A) onto the **Gas Supply Pipe** (Figures 5 and 6B) and wrench tighten. If space between Gas Supply Pipe and Firebox floor allows, the flared end of the 1/2" FIP x 3/8" Elbow should face down. (Figure 6A)
2. With Burner Pan inside firebox at previously marked position thread one end of the **Flex Connector** (Figures 5 and 6C) to the **1/2" FIP x 3/8" Flared Elbow** and wrench tighten. Do not use pipe compound or tape on *any* flared threads.
3. Carefully bend the **Flex Connector** into position, connect to the **Orifice holder** and wrench tighten. If Flex Connector is bent into too small of a radius it may kink or break causing air flow noise and/or gas leaks.
4. Proceed to Page 11 "Pan Medium Installation"

FIGURE 5
Side View

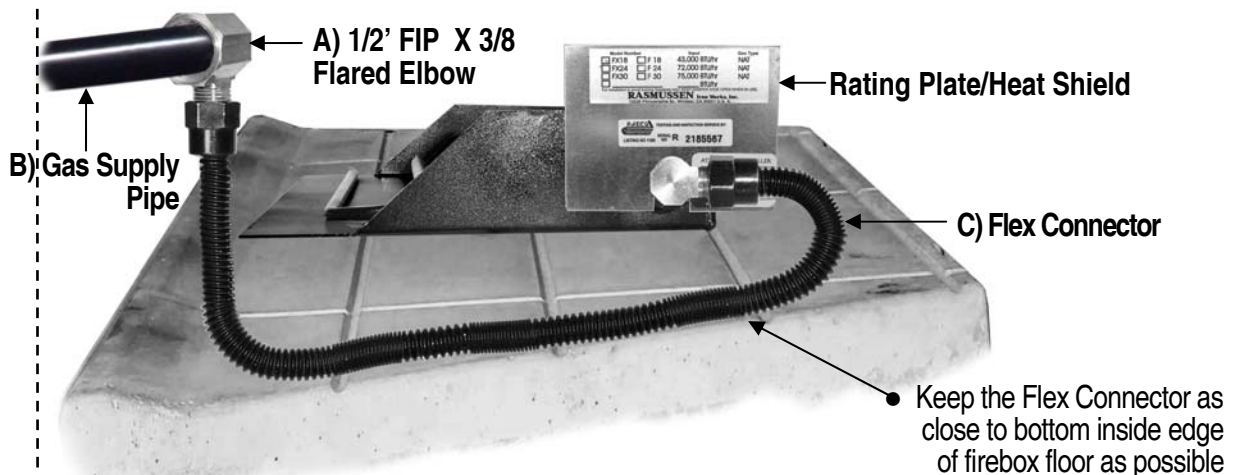

STEP FOUR: GAS SUPPLY CONNECTION FOR STANDARD MATCH LIGHTED (Cont'd)

FIGURE 6

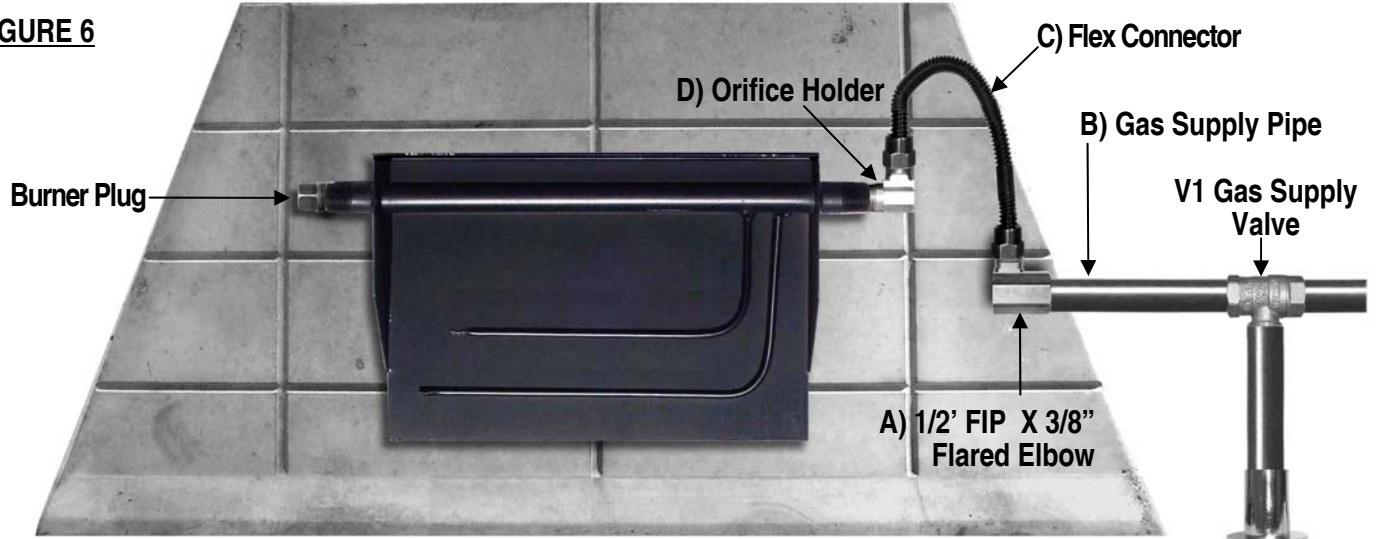

(FX18 Burner Pan used for example)

OPTIONAL ACCESSORY MATCH LIGHTED WITH MANUAL "V-17" VALVE (NATURAL GAS MODELS ONLY)

STEP THREE: BURNER PAN ASSEMBLY

NOTE: If fittings do not come pre-wrapped with Teflon threaded tape, pipe compound **MUST** be applied to all tapered pipe threads (except in #3 of Step 3) to prevent gas leaks. **DO NOT** use Teflon tape or pipe compound on *any* flared fitting threads.

1. Thread **Burner Plug** (Figure 7A.) into the **Burner Pipe** at opposite end of gas supply (Figure 7B) and wrench tighten. (If not already installed at Factory)
2. Thread **3/8" Street Elbow** (Figure 7C) into Burner Pipe and wrench tighten into position shown.
3. Thread **Orifice Spud** (Figure 7D) (*Without* using pipe compound or Teflon tape) into **3/8" V-17 Valve** (Figure 7E), then thread Valve into 3/8" Elbow and wrench tighten into position shown.

NOTE: The Orifice Spud is a gas consumption limiter. Higher flames (and greater gas consumption) may result if orifice spud is not installed.

4. Insert **Rating Plate/Heat Shield** (Figure 7F) between the burner pipe and the 3/8" Street Elbow.
5. Insert **Key Sleeve** (Figure 7G) over **V-17 Valve Stem** (7I)

FIGURE 7

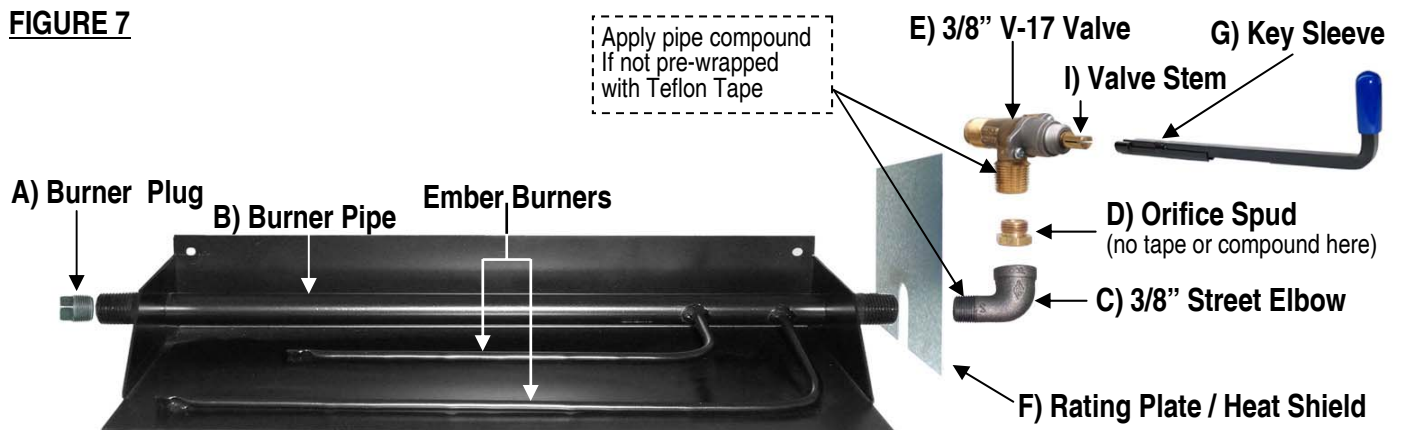

ACCESSORY MATCH LIGHTED WITH MANUAL "V-17" VALVE (NATURAL GAS MODELS ONLY)

STEP FOUR: GAS SUPPLY CONNECTION (ENSURE THAT GAS SUPPLY TO FIREPLACE IS OFF)

NOTE: If fittings do not come pre-wrapped with Teflon threaded tape, pipe compound **MUST** be applied to all tapered pipe threads (except in #3 of Step 3) to prevent gas leaks. **DO NOT** use Teflon tape or pipe compound on *any* flared fitting threads.

1. Thread **1/2" FIP x 3/8" Flared Elbow** (Figures 8 and 9A) onto the **Gas Supply Pipe** (Figures 8 and 9B) and wrench tighten. If space between Gas Supply Pipe and Firebox floor allows, the flared end of the 1/2" FIP x 3/8" Elbow should face down. (Figure 9A)
2. With Burner Pan inside firebox at previously marked position thread one end of the **Flex Connector** (Figures 8 and 9C) to the **1/2" FIP x 3/8" Flared Elbow** and wrench tighten. Do not use pipe compound or tape on *any* flared threads.
3. Attach **Flex connector** to the tapered end of the V17 valve (Figure 9D). Remember, If Flex Connector is bent into too small of a radius it may kink or break causing air flow noise and/or gas leaks.
4. Proceed to Page12 "Pan Medium Installation")

FIGURE 8



FIGURE 9
Side View

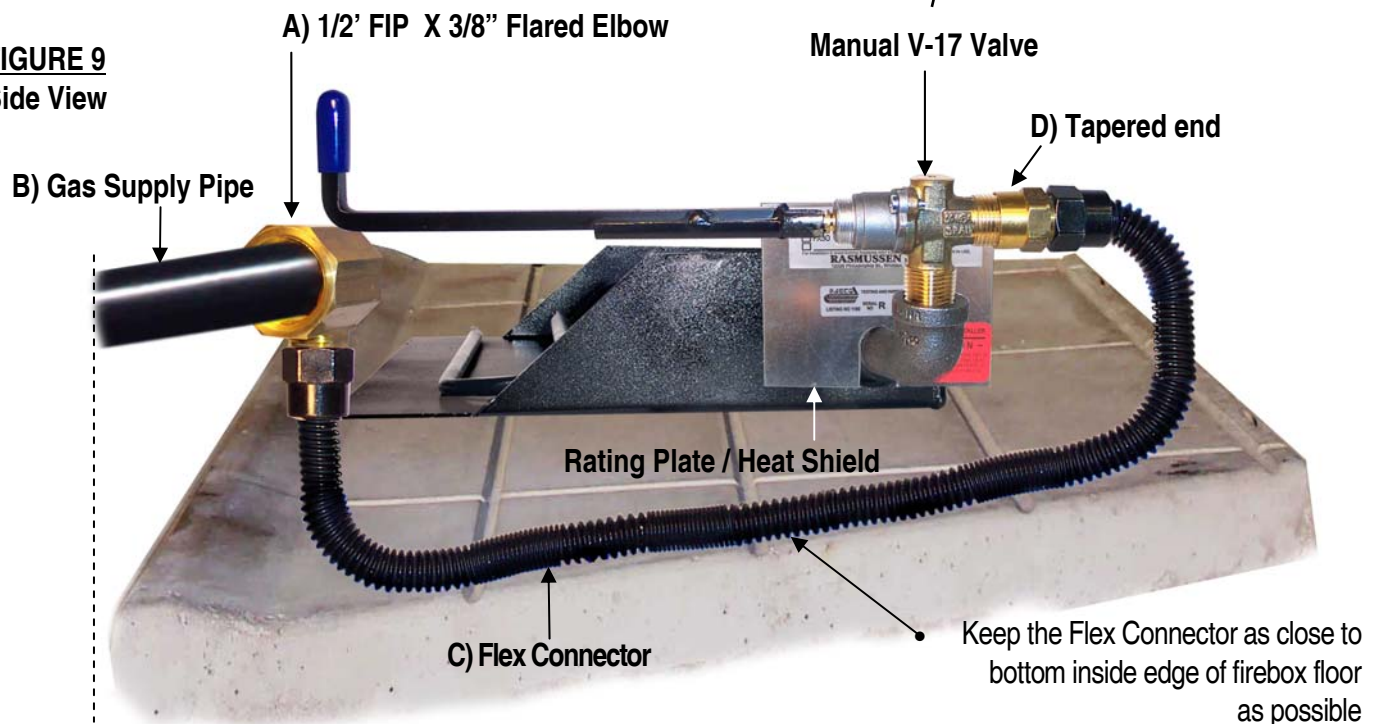

WARNING:

AN "EASY" SAFETY PILOT MUST BE INSTALLED ON ALL UNITS DESIGNED OR CONVERTED TO BURN PROPANE GAS. THE "EASY" SAFETY PILOT CONTROL SYSTEM IS OPTIONAL FOR NATURAL GAS UNITS.

If utilizing the "EASY" Safety Pilot System with your Flaming Ember Burner use the individually supplied instructions in conjunction with this instruction manual.

SPK3E

Manual Safety Pilot Control

The Manual Safety Pilot Control (standing pilot) provides safety shutdown in the event of an interruption of the gas supply or flameout. It also provides a convenient means of lighting the burner and controlling flame height. A safety control is required for all propane installations, advisable for natural gas, and is required for certain jurisdictions. "EASY" control allows for upgrade to remote operation at a later time. Refer to individually supplied instructions.



RMC1E

Wireless Variable Flame Height Remote Safety Pilot "EASY" Control.



Light the burner and adjust the flame height with the hand-held wireless remote transmitter. Provides safety shutdown in the event of an interruption in the gas supply or flameout. It also provides a convenient means of lighting the main burner. A safety control is required for all Propane installations, is advisable for natural gas, and is required in certain jurisdictions. (Comes with Variable Flame Height Remote Control Transmitter, and Remote Receiver). Refer to individually supplied instructions.

RPK3E

Remote Ready Safety Pilot "EASY" Control.

Requires one of the Wireless Remoter Transmitter Devices (below) to light the main burner. Adjust the flame height manually by turning the knob at the valve. Provides safety shutdown in the event of an interruption in the gas supply or flameout. Also provides a convenient means of lighting the main burner. A safety control is required for all Propane installations, is advisable for natural gas, and is required in certain jurisdictions. The RPK3E Model comes with the Remote Receiver shown below left and may be controlled by any one of the five Wireless Remote Transmitter Devices shown here (each sold separately) Refer to individually supplied instructions.



STEP FIVE: PAN MEDIUM (NATURAL GAS MODELS)

If using a Natural Gas model, the Pan Medium is White Sand. Volcanic Ash may *only* be used as dressing for the firebox floor (Figure 14). Volcanic ash is recommended for the pan filler for outdoor installation of the burner.

1. Completely cover **Burner Pipe** and **Ember Boosters** (if applicable) with Pan Medium (Figure 10) Starting from rear of Burner Pan and moving toward leading edge. Use entire contents of bag provided, allowing medium to spill over leading edge of burner pan (Figure 11). (Amount supplied will vary with each style burner)

FIGURE 10

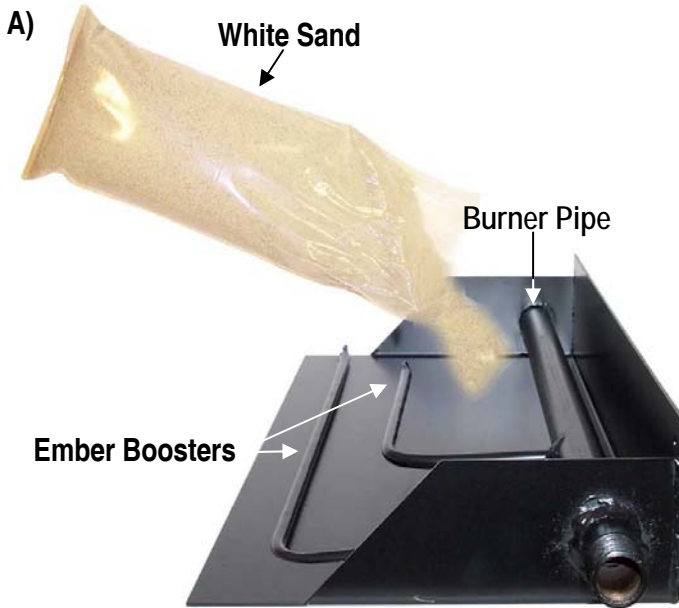

FIGURE 11



2. Sprinkle a light covering of “Ember Magic” over the Pan Medium (Figure 10 below). Pull apart “Ember Magic” fiber material into small, loose pieces to enhance the glowing ember effect. Spread remaining “Ember Magic” around ends of pan to add to the ember bed appearance. When done the Burner Pan should look somewhat like the illustration below.

FIGURE 12



WARNING: Wash hands after handling “Ember Magic” as it may cause skin irritation. When pouring Pan Medium (White Sand) into burner pan do so slowly as it may stir up dust particles. Careful not to breath in dust.

STEP FIVE: PAN MEDIUM (PROPANE MODELS)

If using a Propane burner, the Pan Medium used will be Volcanic Ash (Amount supplied will vary with each style burner). **NEVER** use White Sand inside a propane burner pan.

1. Completely cover **Burner Pipe** and **Ember Boosters** with the provided Black Volcanic ash (Figure 13) Starting from rear of Burner Pan and moving toward leading edge. Use entire contents of bag provided, allowing medium to spill over leading edge of burner pan (Figure 14A).

FIGURE 13

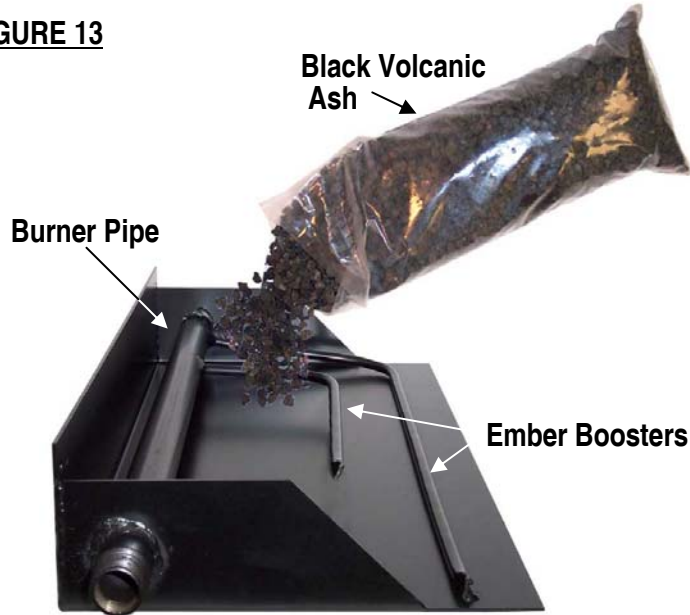
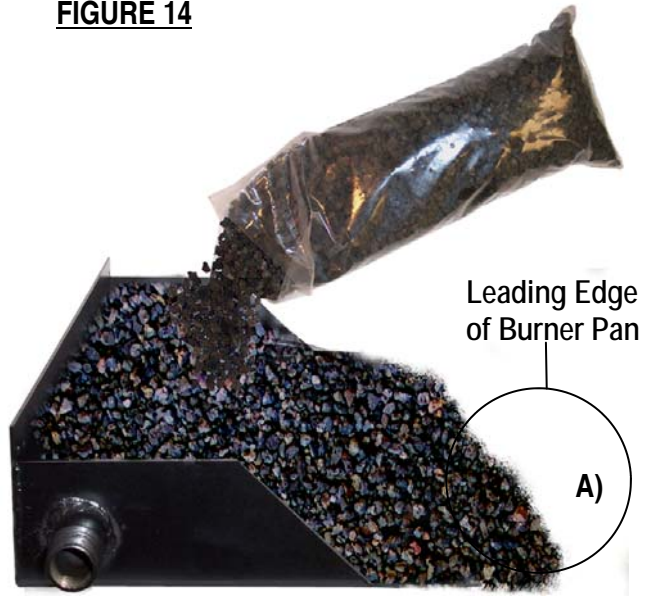

FIGURE 14



2. Sprinkle a light covering of “Ember Magic” over the Black Volcanic Ash. Pull apart “Ember Magic” fiber material into small, loose pieces to enhance the glowing ember effect. Spread remaining “Ember Magic” around ends of pan to add to the ember bed appearance. When done the Burner Pan should look somewhat like the illustration below.

FIGURE 15



WARNING: Wash hands after handling “Ember Magic” as it may cause skin irritation.

WARNING: Failure to position the parts in accordance with these diagrams or failure to use only parts specifically approved with this heater may result in property damage or personal injury.

FIGURE 16

Natural Gas burner shown with Optional Manual V17 Valve (Figure 16A) and Volcanic Ash (Figure 16B) sprinkled around the outside of the Burner Pan for a decorative effect. Volcanic Ash may also be used to conceal the Flex Connector (Figure 16C).

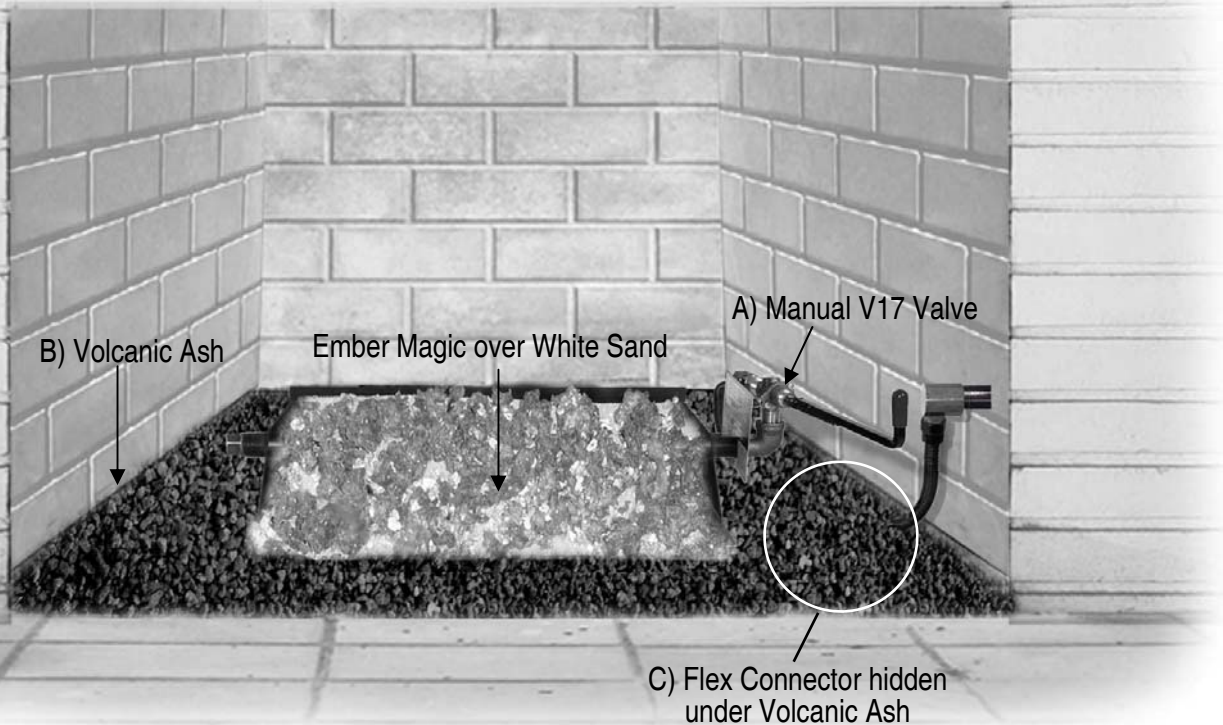
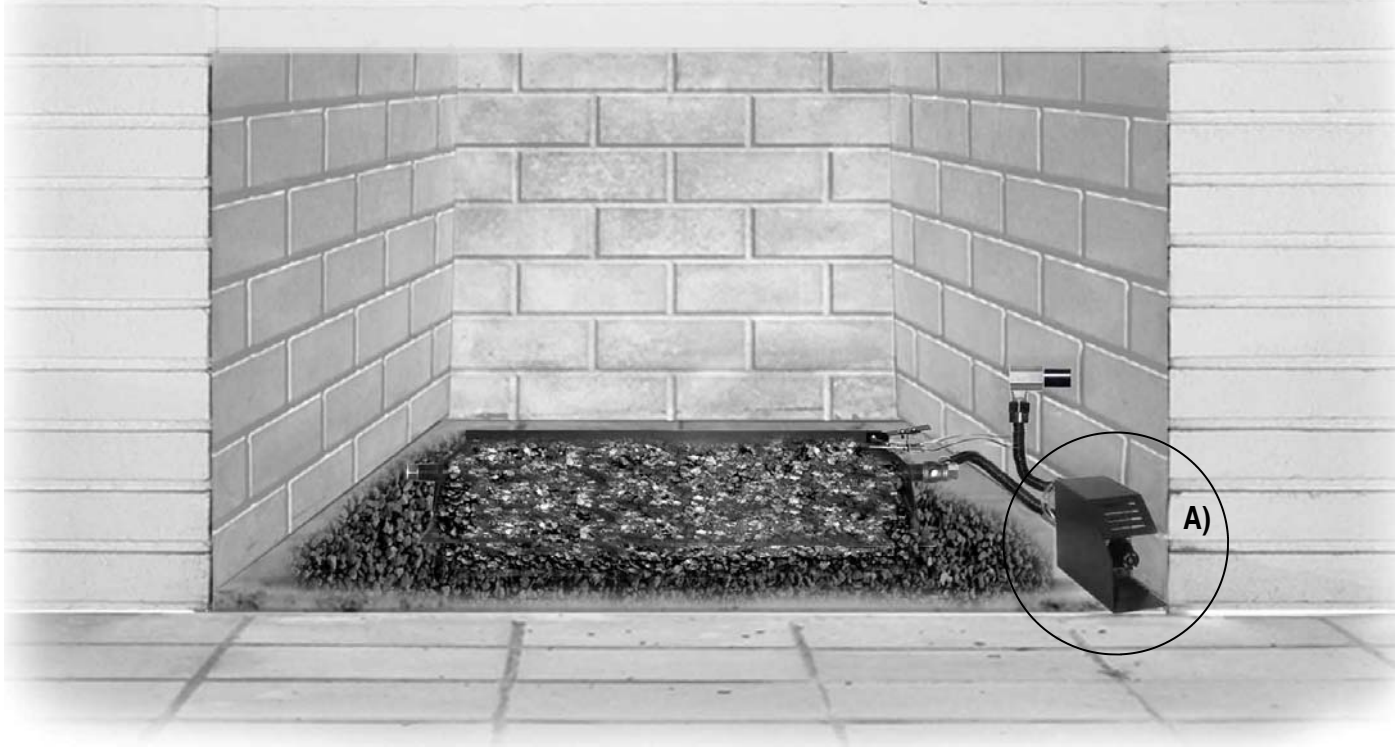

FIGURE 17

Propane model shown with Optional SPK3E Control (Figure 17A), Volcanic Ash used inside the Burner Pan as pan medium and sprinkled around the outside of the Burner Pan for a decorative effect. Volcanic Ash may also be used to conceal the Flex Connector (as in Figure 15C above) but DO NOT obstruct air mixer holes.



STEP 6: LOG PLACEMENT

CAUTION: Crowded logs will cause poor combustion and result in excessive soot formation.

Depending on the log style and size, log sets contain from 6 to 10 individual logs and sometimes pine cones. The largest logs will be the **Front** and **Rear Logs**. Some log sets have two separate front logs which simulate a charred/burnt effect between the two halves. (Figure 18) Place the **Longest Log** (or 2 largest “charred” logs if applicable) as far forward on the Grate as possible. The **next Longest Log** is placed as far to the rear as possible on top of optional **Log lifters** (Figure 18A) (if provided). The remaining logs, or “**Top Logs**” are placed diagonally across the Front and Rear logs with the larger top logs placed first allowing flame to pass freely between them. Several examples are provided below with the Burner Pan and Valve omitted for clarity.

FIGURE 18
Side View of 18” Lone Star log set

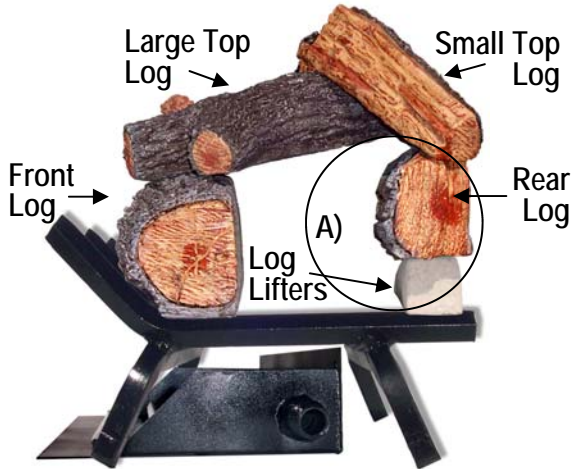

FIGURE 19
Front View of 24” Crossfire log set

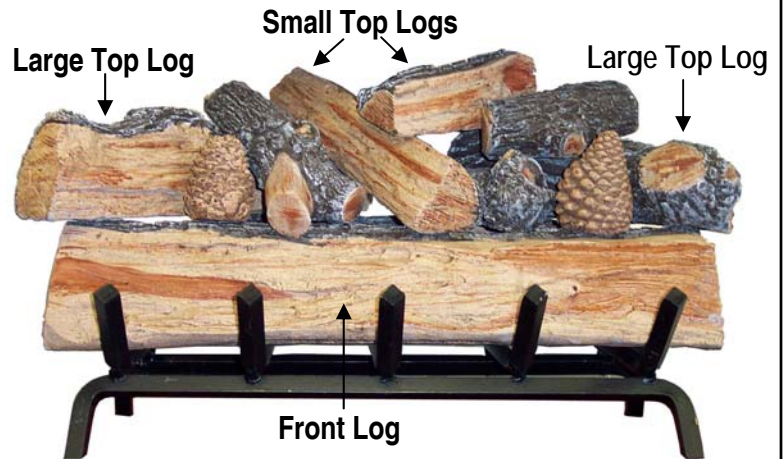

FIGURE 20
Top View of 18” Lone Star log set

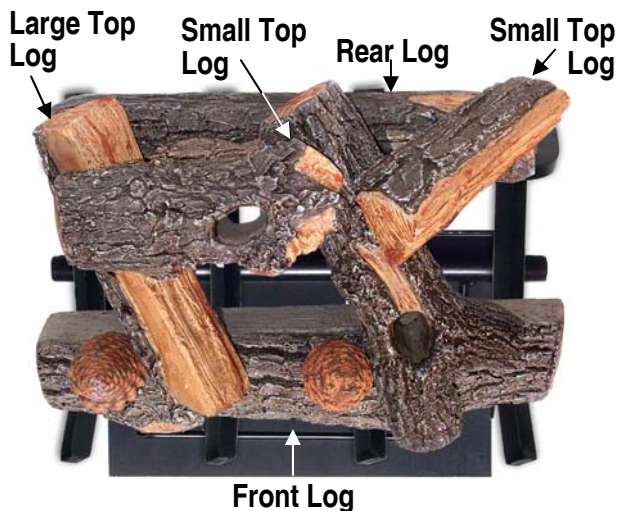
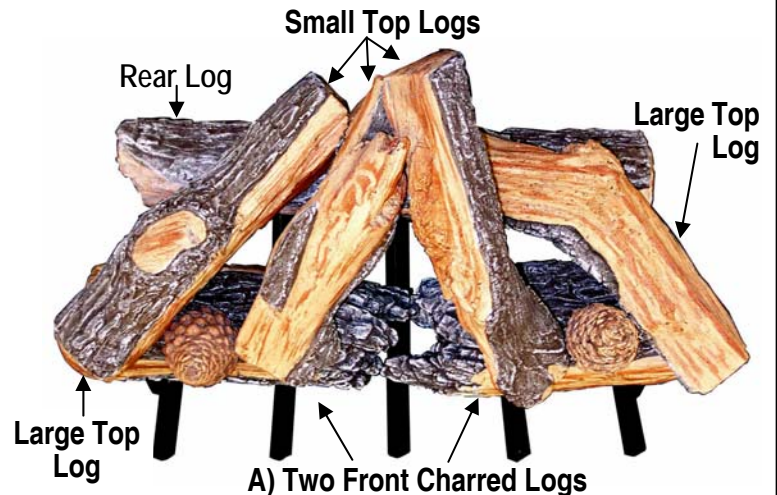

FIGURE 21
Top View of 24” Evening Crossfire log set



DAMPER AND GLASS DOORS MUST BE FULLY OPEN BEFORE LIGHTING OR BURNING FOR PROPER VENTILATION AND TO PREVENT HEAT DAMAGE TO THE VALVE.

IMPORTANT: YOUR GAS LOG SET SHOULD BE OPERATED FOR THE FIRST 2-3 HOURS AT A LOW FLAME SETTING TO ALLOW TEMPERING OF THE REFRACTORY LOGS.

FIGURE 22

Fully Assembled Evening Crossfire Log Set shown with Optional Manual V17 Valve.



STEP SEVEN: LIGHTING AND OPERATION INSTRUCTIONS

WARNING: Failure to position the parts in accordance with these diagrams or failure to use only parts specifically approved with this appliance may result in property damage or personal injury.

Applies to Natural Gas Models F, FH, FX, FXH. All other models refer to supplied instructions.

BEFORE LIGHTING: Smell around the burner area and next to floor for gas. Propane gas is heavier than air and may settle on the floor. If you smell gas follow the instructions on page 1.

• **STANDARD MATCH LIGHTING**

1. Place lighted match on embers near inlet end of burner (Figure 23).
DO NOT HOLD MATCH IN HAND! Move away from front of fireplace.
2. Slowly open Fireplace Gas Supply Valve and wait for burner to light.
3. Adjust Fireplace Gas Supply Valve for desired flame height.
4. To shutdown close Fireplace Gas Supply Valve completely.

• **MATCH LIGHTING WITH OPTIONAL ACCESSORY V-17 VALVE**

1. Ensure that the Manual V-17 Valve is completely closed.
2. Open Fireplace Gas Supply Valve.
3. Place lighted match on embers near inlet end of burner (Figure 23)
DO NOT HOLD MATCH IN HAND! Move away from front of fireplace.
4. Slowly open Manual V-17 Valve and wait for burner to light.
5. Adjust Fireplace Manual V-17 Valve for desired flame height.
6. To shutdown close both Manual V-17 Valve and Fireplace Gas Supply Valve completely.

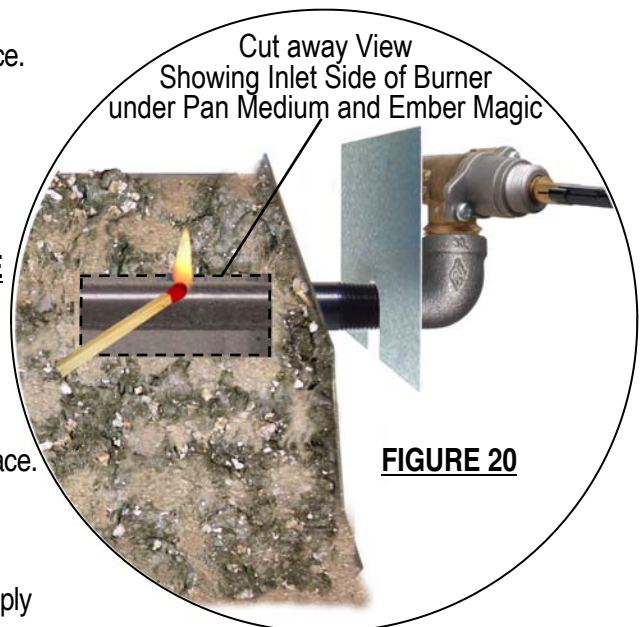

PROPER MAINTANANCE

- Keep the area around the log set clean and clear of debris.
- When logs develop soot, turn burner on for 15 minutes then lightly spray soot areas with water. Soot will then evaporate.
- Periodically examine and clean the venting system. Once every year, a qualified agency or certified chimney sweep should examine and clean the venting system of the solid fuel burning fireplace in which the log set is installed.

APPLIANCE BREAK-IN

During the 2-3 hour appliance break-in period, you may detect an odor from the appliance as the various water- based paints used in the manufacture of this log set cure. This is normal and temporary situation that is not a cause for alarm. However, you may want to provide extra ventilation to the room during this time.

To ensure proper curing of the logs:

- 1) Ignite a 2" flame and maintain it for 1/2 hour.
- 2) Burn the logs in consecutive 1/2 hour periods, raising the flame an additional 2" to full flame height for a total of three hours.

TROUBLE SHOOTING

Log Set is Smoking/Sooting Excessively

It is natural and unavoidable for vented log sets to produce moderate levels of carbon (soot) where flame contacts the logs. However, if soot is produced where there is no flame impingement, one of the following may be the cause;

Fireplace venting system not drafting properly: Make sure the damper is wide open at all times. Preheat the flue in very cold weather by burning the log set at very low level, then slowly increasing the flame height over a matter of hours. Have the fireplace and the venting system professionally cleaned.

Excessive flame impingement or blockage: Make sure there is proper spacing between the logs so they are not smothering the flame. Rearrange the logs so they are touched less by the flames.

Excessive gas supply/pressure: Make sure the gas pressure coming into the fireplace does not exceed the maximum pressure allowed with this gas set (refer to page 2). If you are using the gas logs with an "EASY" Safety Pilot Kit, make sure you installed the correct orifice into the set.

Burner is Excessively Noisy

Please Note: The movement and combustion of gas will create low, unavoidable levels of noise.

Excessive gas pressure: Make sure the gas pressure coming into the fireplace does not exceed the maximum pressure allowed with this gas set (refer to page 2). If you are using the gas logs with an "EASY" Safety Pilot Kit, make sure you installed the correct orifice into the set.

Passage of air/gas across irregular surfaces: There may be burrs, paint or other blockages on the burner bar ports. Check these ports and remove any blockage.

Gas Connector: Relieve any tight bends or kinks in the Flex Connector or switch to a smooth aluminum or copper connector, which can be purchased at hardware or home improvement stores. Do not use Flex Connectors other than those supplied by Rasmussen.

Burner Flame is Too High (8-12" Above Top Logs) or Too Low (Below Top Logs)

Incorrect gas supply, pressure, or burner orifice used: Make sure the gas pressure coming into the fireplace falls between the minimum and maximum pressures allowed with this gas set (refer to page 2). If you are using the gas logs with a safety pilot kit, make sure you installed the correct orifice.

Blocked ports (low flame only): Free the main burner orifice and burner bar ports of any burrs, paint or other blockage.

SERVICE AND TROUBLESHOOTING GUIDE FOR MODELS USING THE "EASY" SAFETY PILOT KIT

Analysis and correction of control of service problems must be made by qualified gas service technicians only. Attempts to service or repair the "EASY" Safety Pilot Kit by other than authorized service personnel will void the manufacture's warranty. In general , failure of "EASY" Safety Pilot Control may be due to the reasons noted below:

1. Pilot will not light initially:
 - Check for loose Thermocouple terminal nut connection. Finger tip tighten plus 1/4 turn with wrench.
 - Check for improper pilot flame adjustment.
 - Check that Valve Knob is fully depressed during pilot lighting operation and held depressed for 30 to 60 seconds.
 - Check for defective Thermocouple.
 - Check for defective thermo magnet unit.
2. Pilot / Main burner clicks off after 5 to 30 minutes of burning:
 - Valve and Thermocouple are not defective, otherwise pilot would not initially light.
 - Thermocouple loses temperature difference between hot tip and cold junction (base).
 - Check that only tip of Thermocouple is in main burner flame.
 - Remove then replace logs to alter heat radiation pattern. Ensure that glass doors are open.
 - Ensure that proper size gas log set is installed. Too large of a set decreases cooling air flow.

LIMITED LIFETIME CONSUMER PRODUCT WARRANTY

The following warranty has been drafted to comply with the MAGNUSON-MOSS WARRANTY ACT applicable to products manufactured after July 4, 1975. It replaces and supersedes any warranty in this package or in any printed literature.

LIMITED WARRANTY:

RASMUSSEN IRON WORKS INC, 12028 E. Philadelphia Street, Whittier California, U.S.A., warrants this Gas Log Set and accessories against defects in materials and workmanship, and suitable for a particular purpose, for a period of:

Home (Non-Commercial use):

- (1) LOG CASTINGS - All logs are guaranteed against crumbling in the original installation for the lifetime of the initial purchaser.
- (2) BURNERS/GRATES - 2 Years from date of purchase.
- (3) SAFETY CONTROLS - Pilots and Safety Controls are covered by warranty of the original manufacturer only.

Commercial Use:

All components - 1 year from date of purchase

THIS WARRANTY IS FOR THE BENEFIT OF THE ORIGINAL PURCHASER.

WARRANTY ADJUSTMENT:

- (1) RASMUSSEN agrees to repair or furnish a replacement for, but not remove or install any product or component which proves defective within the above warranty and appropriate time periods stated.
- (2) BUYER notify RASMUSSEN of any defect within this warranty no later than thirty (30) days after a defect is discovered.
- (3) No product will be accepted for return or replacement without written authorization of RASMUSSEN. Before returning merchandise, write to RASMUSSEN Giving us full details of the complaint and a copy of the sales receipt or other evidence of the purchase date. Merchandise returned without proof of purchase date will be serviced out-of-warranty at our prevailing service and parts rates. If merchandise was damaged in transit, the file claim must be addressed as follows:

RASMUSSEN IRON WORKS INC
12028 E. PHILADELPHIA STREET
WHITTIER, CALIFORNIA 90601

**Shipping charges must be pre-paid by the buyer.
REPAIR OR REPLACEMENT UNDER THIS WARRANTY WILL BE
SHIPPED FREIGHT COLLECT.**

EXCLUSIONS FROM WARRANTY:

- (1) The foregoing warranty is limited solely as set forth herein and applies only for the designated above.
- (2) RASMUSSEN shall not be liable for any loss, damage incidental or consequential damages of any kind, whether based upon warranty, contract, or negligence, arising in connection with the sale, use or repair of the product. Some states do not allow the exclusion or limitation of incidental or consequential damages, so the above limitation or exclusion may not apply to you.
- (3) The maximum liability of RASMUSSEN in connection with this limited warranty shall not in any case exceed the contract price paid for the product claimed to be defective or unsuitable.
- (4) This warranty does not extend to any product manufactured by RASMUSSEN which has been subjected to misuse, neglect, accident improper installation, or use in violation of instructions furnished by RASMUSSEN.
- (5) This warranty does not extend to or apply to any unit which has been repaired or altered in any place other than RASMUSSEN IRON WORKS INC. factory, or by persons not expressly approved by RASMUSSEN.
- (6) Components manufactured by any supplier other than RASMUSSEN shall bear only that warranty made by the manufacturer of that product.
- (7) Freight damage, cracking from thermal shock, and color changes occur from causes beyond manufacturer's control and are not covered by any warranty.

THIS WARRANTY GIVES YOU SPECIFIC LEGAL RIGHTS, AND YOU MAY ALSO HAVE OTHER RIGHTS WHICH VARY FROM STATE TO STATE.

RASMUSSEN IRON WORKS, INC. shall be held harmless from any and all claims by the buyer as a result of injury or damage to an Ultimate user or other person caused by the product sold herein by the seller to the buyer, whether the injury or damage results from the assembly, product installation, operation, shipment, storage or manufacture of this product. RASMUSSEN IRON WORKS, INC. makes no warranties, expressed or implied, other than those expressly stated herein.

* CUSTOMER RESPONSIBILITY *

Your Gas Log is designed to burn with a natural smoky yellow flame that produces carbon soot. Like a wood fire, burning a Gas Log with the flue blocked or closed will cause fumes and smoke to remain in the room and cause health hazards.

DAMPER MUST BE FULLY OPEN WHEN BURNING A GAS LOG SET.

CONSUMER RECORD CARD

Please record and retain information for future reference. Register your product at www.rasmussen.biz



LOG MODEL: _____

SAFETY CONTROL: _____

DATE OF PURCHASE: _____

DEALER: _____

INSTALLER: _____