

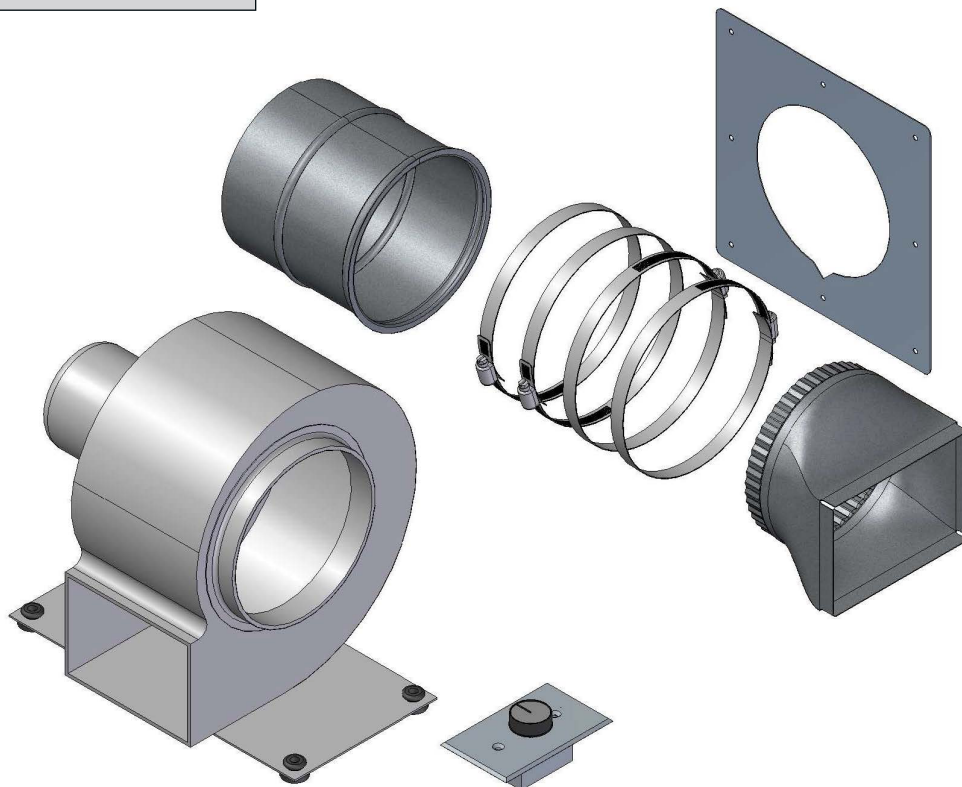

INSTALLATION INSTRUCTION
FORCED AIR KIT
(VA4460)

INSTALLATION BY A
PROFESSIONAL IS STRONGLY
RECOMMENDED



This manual is available for free download on the manufacturer's web site. It is a copyrighted document. Re-sale is strictly prohibited. The manufacturer may update this manual from time to time and cannot be responsible for problems, injuries, or damages arising out of the use of information contained in any manual obtained from unauthorized sources.

1 - KIT CONTENTS

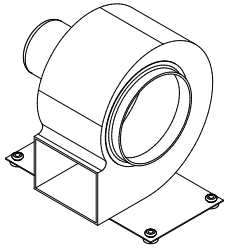

1x

Blower

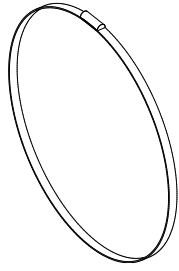

4x

Duct collar 6"

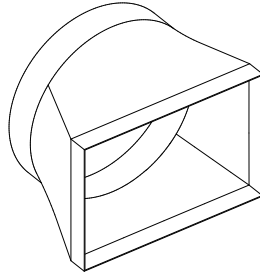

1x

Fan adapter

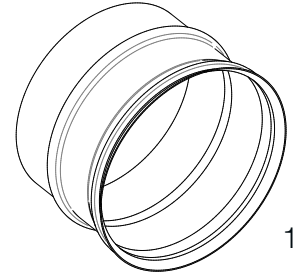

1x

6" Fireplace connector

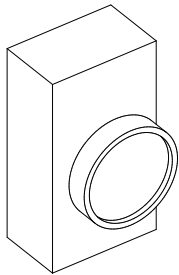

1x

Rheostat

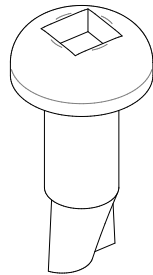

3x

Screws #8x 1/2"

2 - ACCESSORIES REQUIRED (NOT INCLUDED)

3 - NECESSARY TOOLS

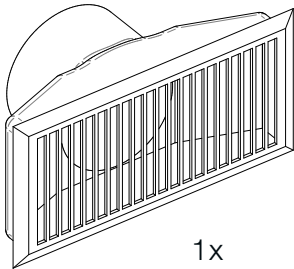

Air outlet

1x

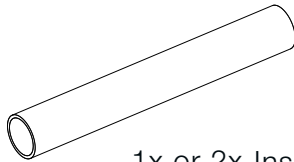

1x or 2x Insulated flexible duct 6" x 25'
UL181 and ULC S110 listed.

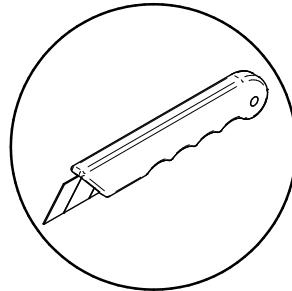
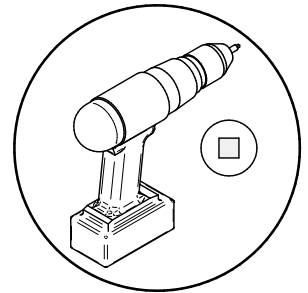
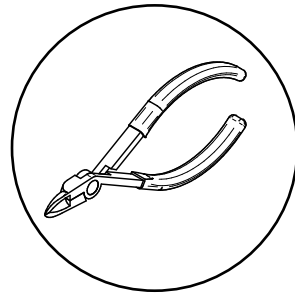

3-APPLICATION

The forced air distribution kit VA4460 can be used to heat adjacent rooms, upper floor or lower floor located up to 50' (15.2 m) from your fireplace. Only 6" (15 cm) insulated flexible duct can be used for such installations. The ducts must comply with ULC S110 Class 1 for Canada and UL181 Class 0 or 1 for USA. The clearance from the ducts to combustibles materials is 0".

If the blower is connected to the rheostat, it must be controlled manually. If the blower is connected with a thermal switch, already installed underneath the firebox, the thermal switch will activate the fan when the fireplace reaches 110°F (50°C) and automatically shut it off when fireplace cools down under 90°F (32°C). Both thermal switch and rheostat can be use simultaneously.

If the fireplace is in a small room, the fan can be used to distribute excess heat in a determined area of the house. **A certain loss of heat is to be expected more the duct length increase.**

WARNING

In Canada, the connection of the forced air kit to a furnace duct is prohibited, unless local building codes allow it. This type of installation is allowed in the USA (UL 391 Standards). However, do not connect any hot air ducts to the cold air return. If the forced air kit duct is to be connected to a furnace hot air distribution system, a backflow shutter (#6, not included) must be installed between the forced air kit fan and the central system hot air duct. To favor an optimum air distribution, it is recommended to connect the forced air kit duct to the furnace duct using an angled connector oriented towards the air outlet.

Keep the fireplace fan electrical circuitry separate from the furnace's fan circuitry. One must not control the other and vice versa.

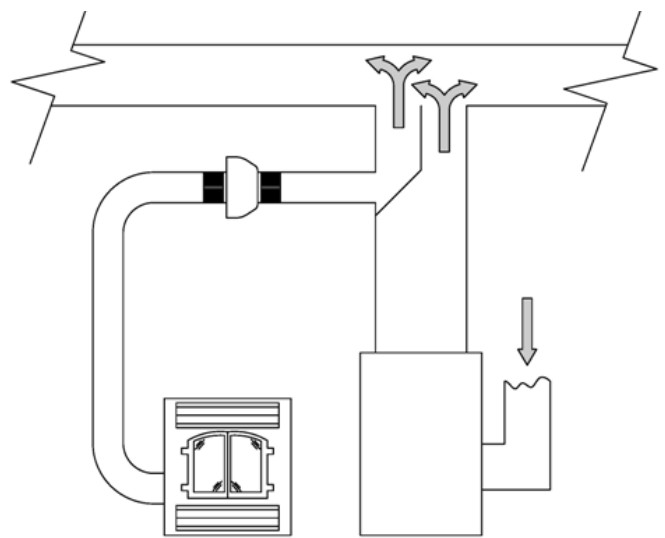
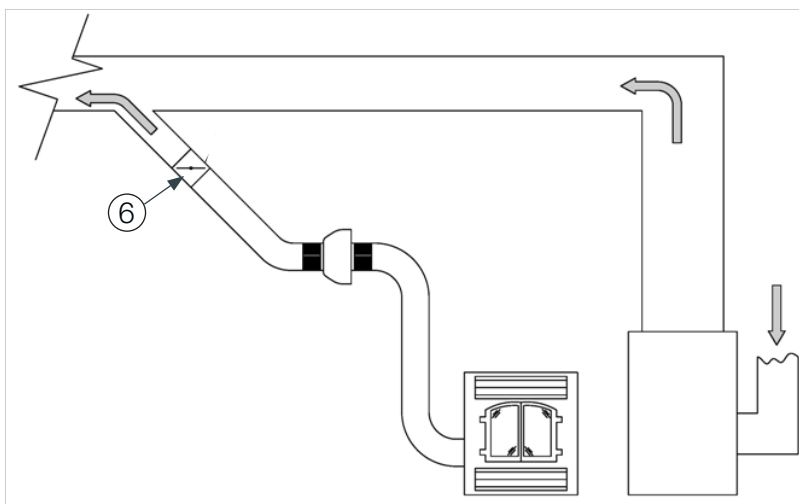

4 - DUCT LENGTH

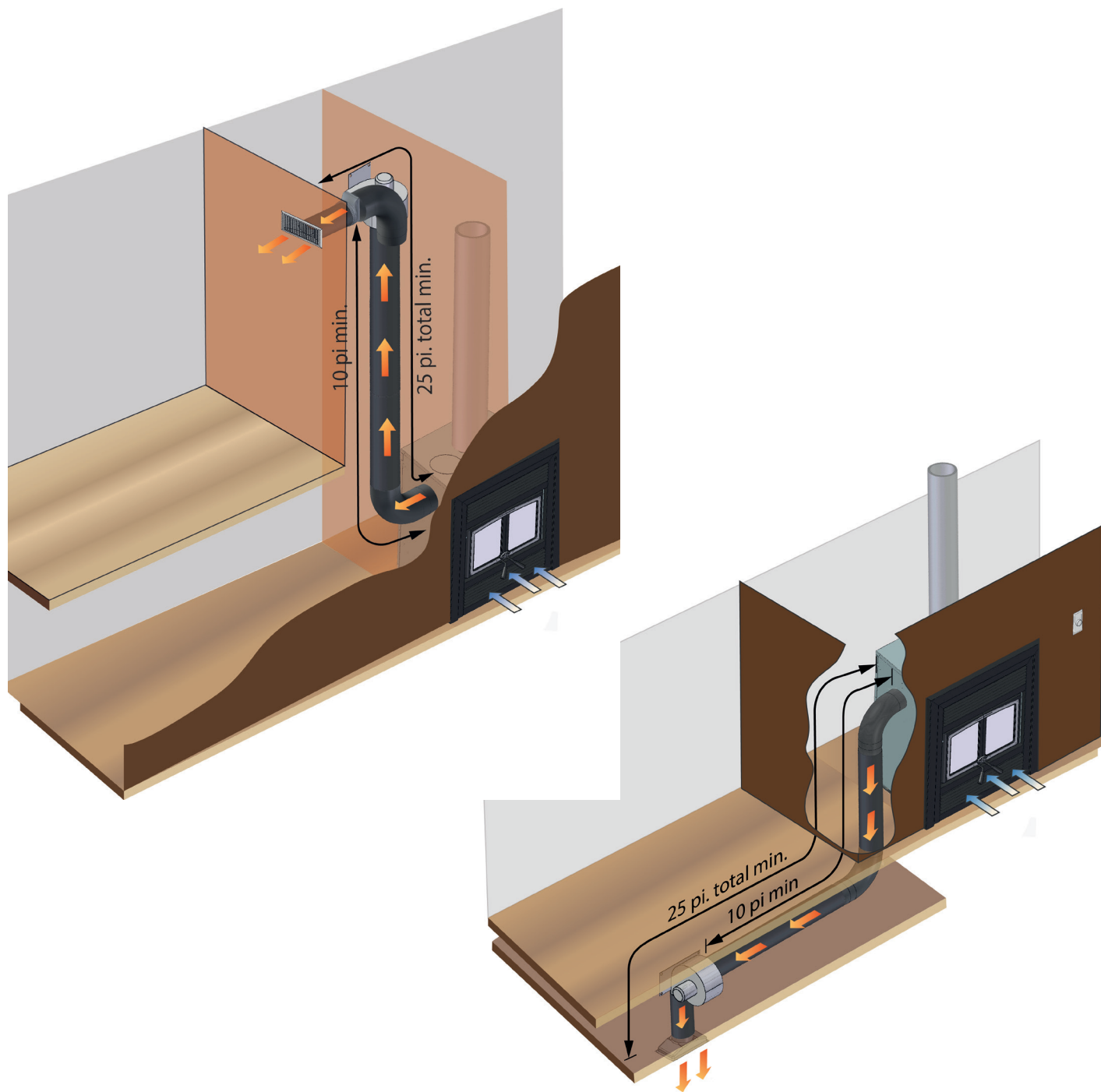

- The fan must be positioned at a minimum distance of 10 feet from the fireplace and outside of its enclosure.
- The total length of the insulated flexible duct must be no less than 25 feet.

5 - FORCE AIR KIT INSTALLATION

1. Select the area to be heated, then the location where you will run the ducting to determine which outlet on the fireplace is the most appropriate for your installation.
2. Once your location is chosen, remove the knockout on the fireplace (#A). Cut the insulation and then the second knockout cover (#A).
3. The connector (#5) will attach to the inner portion.
4. Once secured, you may attach the insulated flexible duct (#B) with the supplied collar (#3). Run the insulated flexible duct (#B) to the adjacent room or lower floor.
5. Install the fan (#2) in a location where you will have access for maintenance (never in the fireplace enclosure) and somewhere the fan's noise will not be disturbing.
6. Once the fan is installed, secure the fan adapter (#4) with the screws (#7). You may connect the insulated flexible duct (#B) to the fan (#2) and to the fan adapter (#4) with the supplied collars (#3).
7. Install the rheostat (#1), preferably near the fireplace so it can be easily turned off before you open the fireplace doors. If the fan is running, smoke could be drawn out of the fireplace instead of up the chimney and sparks may be drawn into the insulated flexible duct.

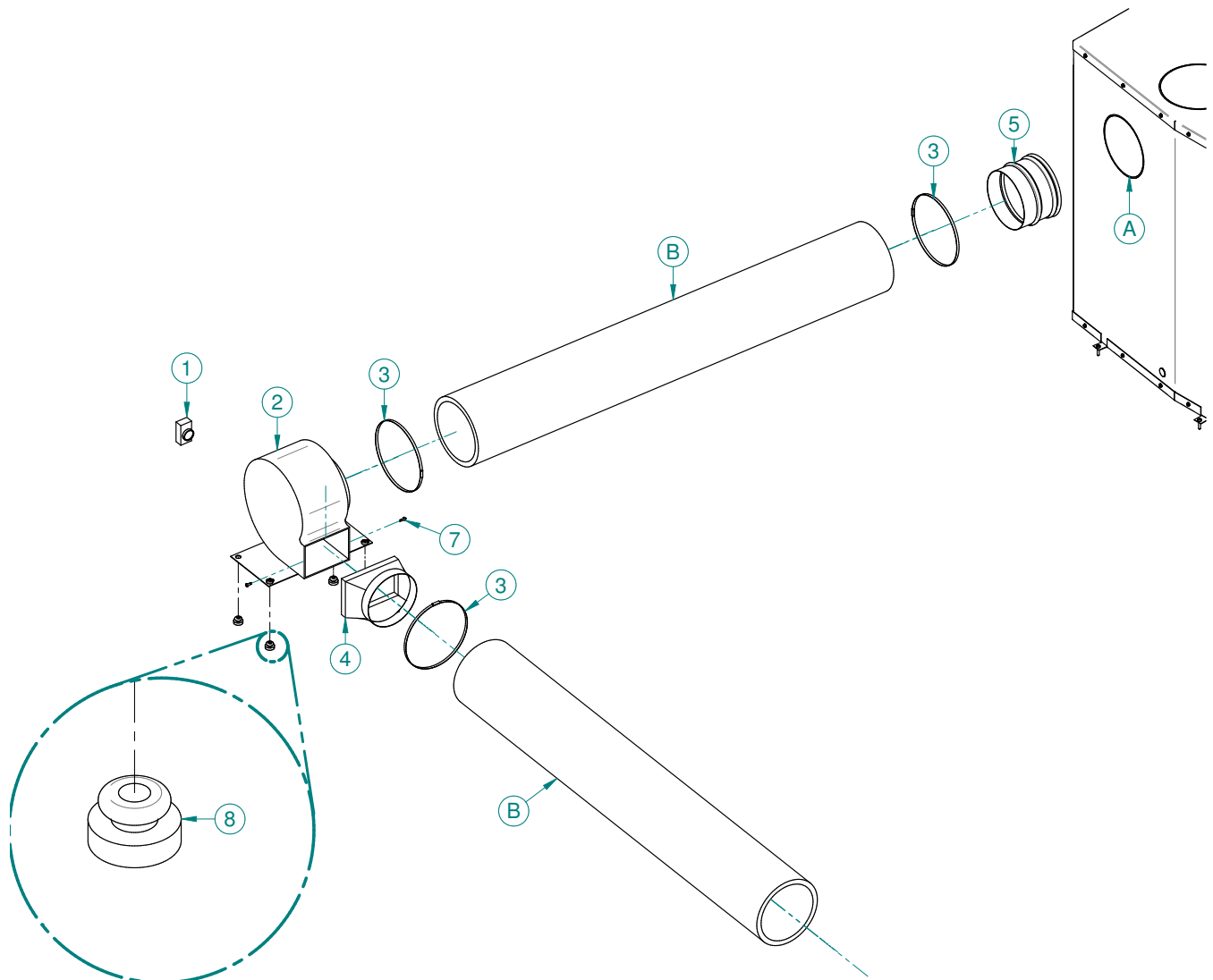

6 - CLEARANCES TO COMBUSTIBLES

- A minimum clearance to combustible materials of 2 inches from the fan is required.
- In Canada, the termination grill must be installed at at least 59" (150cm) from the floor (B).
- A 1" clearance to combustible materials (A) must be left around the termination grill.

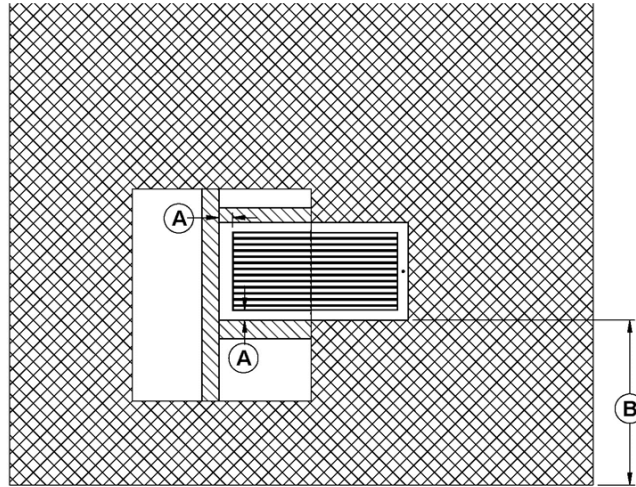

7 - WIRING DIAGRAM

WARNING

- This installation requires electrical power (120V). Make sure all electrical connections are made in the correct order and comply with local regulations as well as the applicable National Building Code standards.
- Keep the fireplace's electrical circuit separate from this forced air kit circuit. **One must not control the other and vice versa.**
- The wiring should be done by a certified electrician.

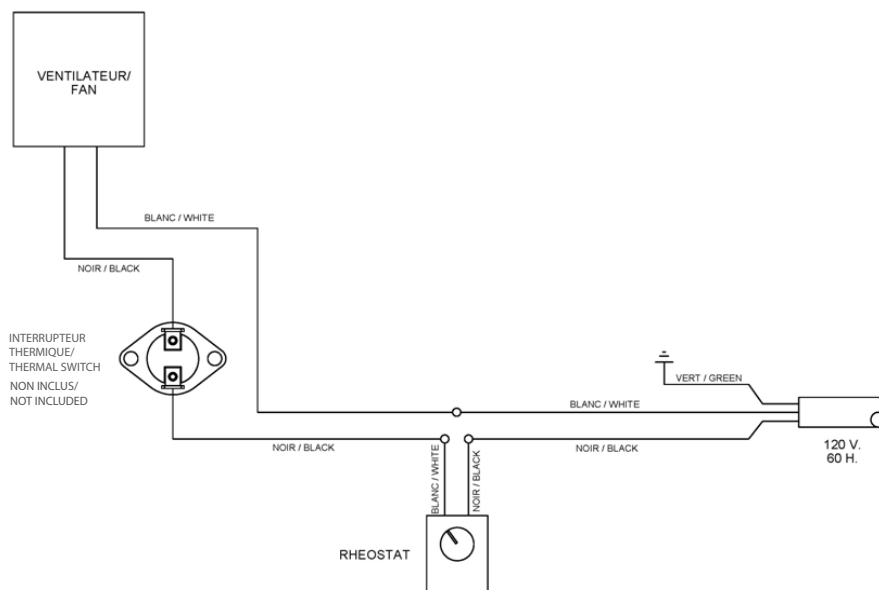

Stove Builder International Inc.
250, de Copenhague street, St-Augustin-de-Desmaures (Québec)
Canada, G3A 2H3

Customer Service : 418-908-8002
Email : tech@sbi-international.com