

XL1200

BIOETHANOL BURNER



Addressing the demand for incorporating stretched flames into custom-designed settings, the linear features of the XL burners perfectly combine their sleek parallel lines with the clean lines of today's contemporary living. An elegant, bright, elongated flame helps 'make' an indoor or outdoor room and creates a distinctive drawcard.

Perfectly and easily integrated into media units, cabinetry, walls, pillars or stone benches, XL burners come in a range of sizes depending on the style you want to achieve. The many, diverse installations around the world are testament to the versatility of these amazing burners.

INDICATIVE MODEL SHOWN BELOW

Global Compliance

All burners are UL Listed in accordance with ANSI/UL1370 in the USA and comply with the ACCC Safety Mandate for Australia.

Flame Regulation

Purpose-designed baffle inserts allow you to regulate and further stabilise the flame at the same time as increasing fuel efficiency of the burner.

Flip Lid Shut Off System

The series' 'flip lid' shut-off system fits perfectly across the ignition zone to extinguish the flame and, when it is open, denies access to the separated filling point as a deterrent to filling the burner while it is in operation.

A reliable and safe extinguishing system courtesy of a special shut-off mechanism and precision measurements.

Colour

Available in Stainless Steel or Black.

Dedicated Filling Point

A patented filling point is separated from the ignition zone and engineered so that the jerry can spout is fully supported prior to releasing the fuel supply. This eliminates the usual splash and spills that would otherwise occur when fuel is decanted into the burner while simultaneously reinforcing the maximum fill line within the burner.

Shut Off Mechanism

XL burners operate under all conditions, at all temperatures, every time – reliable, consistent and reassuring.

Included Accessories

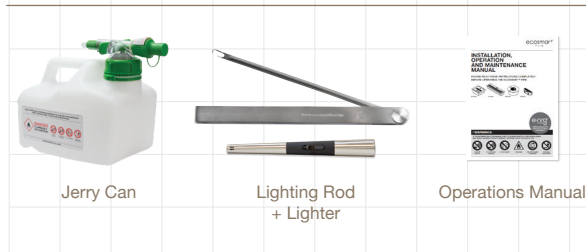

Optional Accessories

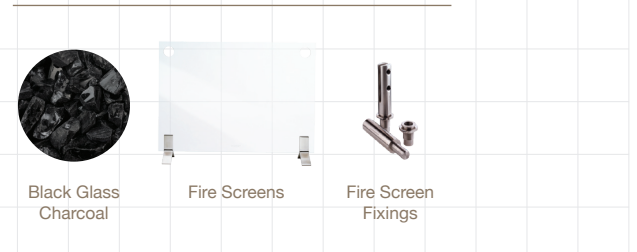

Disclaimer: All product specifications and data are subject to change without notice and believed to be correct at the time of publication. MAD Design Group (MDG), its affiliates, agents, and employees, and all persons acting on its or their behalf (collectively, "MAD Design Group"), disclaim any and all liability for any errors, inaccuracies or incompleteness contained herein or in any other disclosure relating to any product. MDG disclaims any and all liability arising out of the use or application of any product described herein or of any information provided herein to the maximum extent permitted by law. The product specifications do not expand or otherwise modify MDG's terms and conditions of purchase, including but not limited to the warranty expressed therein, which apply to these products. No license, express or implied, by estoppel or otherwise, to any intellectual property rights is granted by this document or by any conduct of MDG. Customers using or selling MDG products not expressly indicated for use in such applications do so entirely at their own risk and agree to fully indemnify MDG for any damages arising or resulting from such use or sale. Please contact authorised personnel from MDG to obtain written terms and conditions regarding products designed for such applications. Images are indicative only.

XL1200

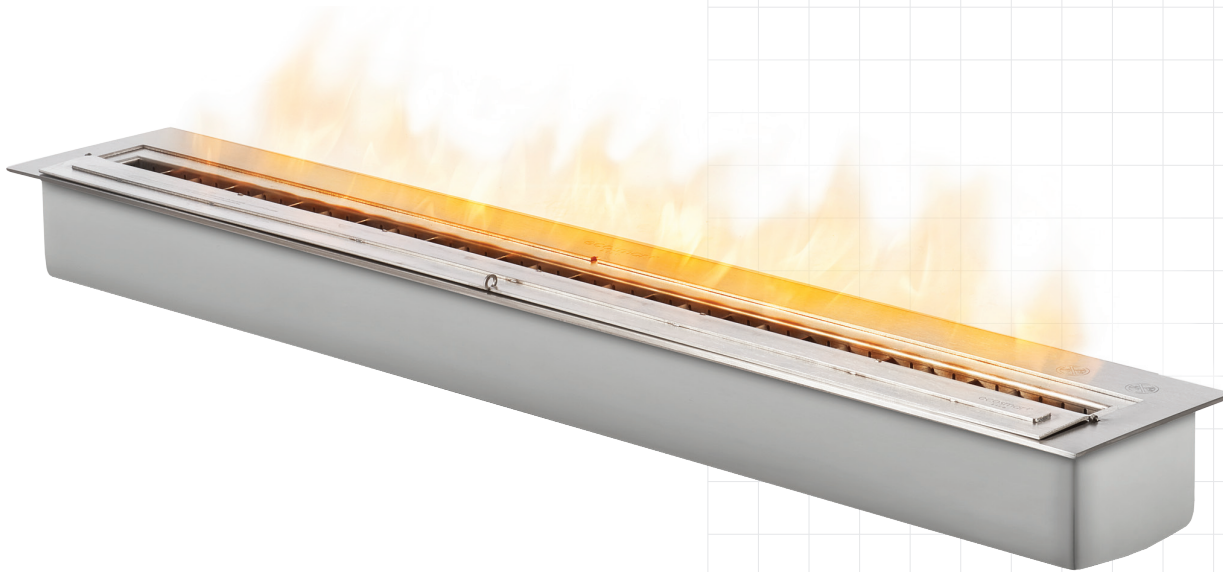

Application	Indoor & Outdoor	
Materials	Grade 304 Stainless Steel, Black Ceramic Coating	
Weight	15.7kg [34.5lbs]	
Color & SKU	 Stainless Steel	ESF.2.B.XL12
	 Black	ESF.2.B.XL12.BL
Fuel Type	e-NRG Bioethanol	

BURNER VENTILATION & EFFICIENCY*

Fuel Capacity	10 Litres [2.6 Gallons]
Heats on Average (when used indoors)	Over 65 square metres [700 square feet]
Fuel Consumption	0.87 L/h [0.23 Gal/h]
Thermal Output Net (MAX)	17 MJ/h - 15,290 BTU/h - 4.5 kW
Burn Time	9 - 14 hours (approx)
Minimum Room Size	115 cubic metres [4061 cubic feet] per burner.

Read the manual carefully before operating the burner. Physical model dimensions should be verified against cut out dimensions BEFORE installation begins to confirm tolerances align.

*These values are indicative only and may vary depending on the model purchased, installation, and the seasonal resource used to manufacture e-NRG.



Global Compliance
All burners are UL Listed in accordance with ANSI/UL1370 in the USA and comply with the ACCC Safety Mandate for Australia.

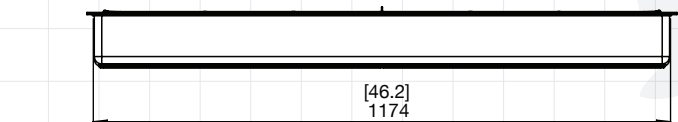

FRONT VIEW

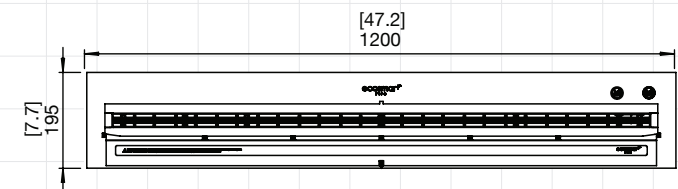

TOP VIEW

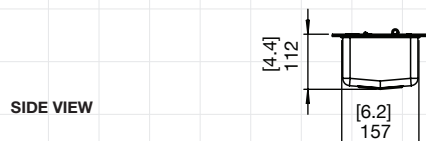

SIDE VIEW

FOR MORE INFORMATION PLEASE REFERENCE THE OPERATION & INSTALLATION MANUAL

Disclaimer: All product specifications and data are subject to change without notice and believed to be correct at the time of publication. MAD Design Group (MDG), its affiliates, agents, and employees, and all persons acting on its or their behalf (collectively, "MAD Design Group"), disclaim any and all liability for any errors, inaccuracies or incompleteness contained herein or in any other disclosure relating to any product. MDG disclaims any and all liability arising out of the use or application of any product described herein or of any information provided herein to the maximum extent permitted by law. The product specifications do not expand or otherwise modify MDG's terms and conditions of purchase, including but not limited to the warranty expressed therein, which apply to these products. No license, express or implied, by estoppel or otherwise, to any intellectual property rights is granted by this document or by any conduct of MDG. Customers using or selling MDG products not expressly indicated for use in such applications do so entirely at their own risk and agree to fully indemnify MDG for any damages arising or resulting from such use or sale. Please contact authorized personnel from MDG to obtain written terms and conditions regarding products designed for such applications. Images are indicative only.

XL1200 CUT OUT DIMENSIONS

Physical model dimensions should be verified against cut out dimensions BEFORE installation begins to confirm tolerances align.

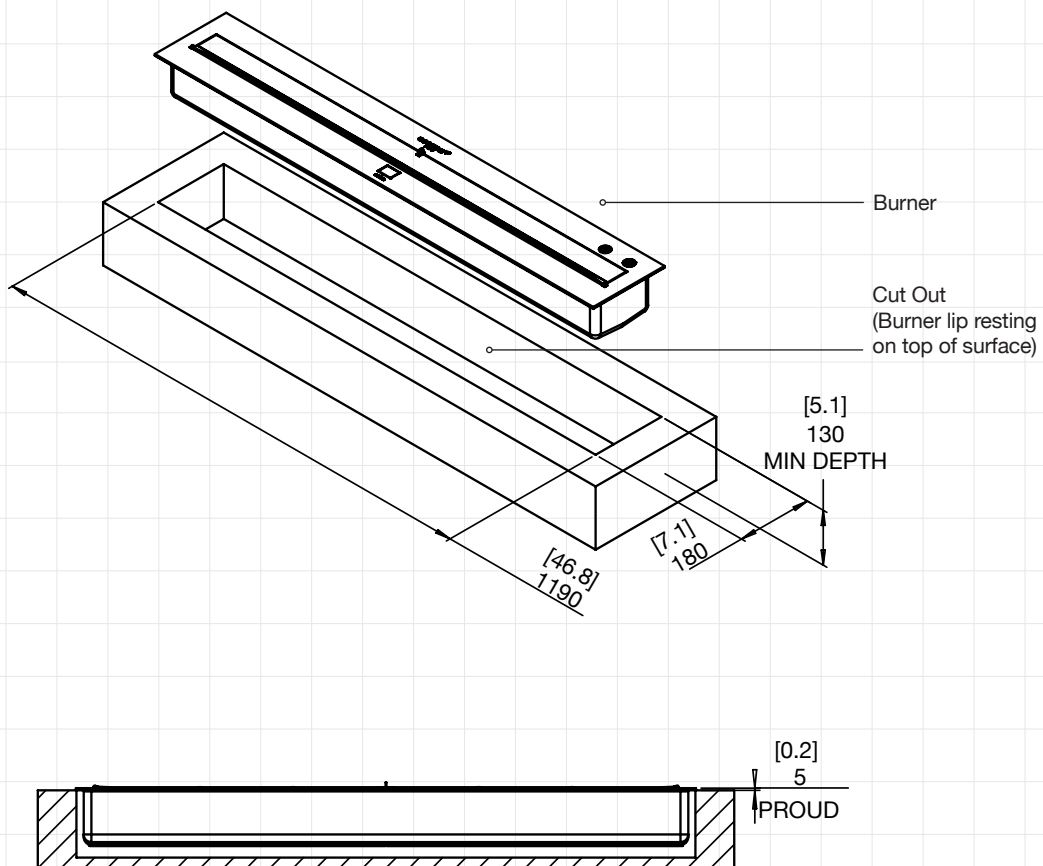

FOR MORE INFORMATION PLEASE REFERENCE THE OPERATION & INSTALLATION MANUAL

Disclaimer: All product specifications and data are subject to change without notice and believed to be correct at the time of publication. MAD Design Group (MDG), its affiliates, agents, and employees, and all persons acting on its or their behalf (collectively, "MAD Design Group"), disclaim any and all liability for any errors, inaccuracies or incompleteness contained herein or in any other disclosure relating to any product. MDG disclaims any and all liability arising out of the use or application of any product described herein or of any information provided herein to the maximum extent permitted by law. The product specifications do not expand or otherwise modify MDG's terms and conditions of purchase, including but not limited to the warranty expressed therein, which apply to these products. No license, express or implied, by estoppel or otherwise, to any intellectual property rights is granted by this document or by any conduct of MDG. Customers using or selling MDG products not expressly indicated for use in such applications do so entirely at their own risk and agree to fully indemnify MDG for any damages arising or resulting from such use or sale. Please contact authorized personnel from MDG to obtain written terms and conditions regarding products designed for such applications. Images are indicative only.