

# BOWLS & PLANTERS



## THE OUTDOOR PLUS

USA MANUFACTURER OF FIRE & WATER PRODUCTS

# CAZO CONCRETE BOWLS

## Cazo Planter Bowl

Includes: Bowl Only (Soil and plants not included.) (3" Opening)

### 24" Bowl OPT-24RP

- » Size: 24"
- » Height: 9"
- » Base: 9"
- » Soil Usage: 1 ft<sup>3</sup>

### 31" Bowl OPT-31RP

- » Size: 31"
- » Height: 10"
- » Base: 10"
- » Soil Usage: 2 ft<sup>3</sup>

### 36" Bowl OPT-36RP

- » Size: 36"
- » Height: 12"
- » Base: 14"
- » Soil Usage: 3 ft<sup>3</sup>

### 48" Bowl OPT-48RP

- » Size: 48"
- » Height: 16"
- » Base: 20"
- » Soil Usage: 1 ft<sup>3</sup>



24" ASH

## Cazo Planter & Water Bowl

Includes: Bowl, Copper Scupper (¾" Inlet) (3" Opening)  
(Soil and plants not included)

### 24" Bowl OPT-24RPW

- » Size: 24"
- » Height: 9"
- » Base: 9"
- » Scupper: 8"
- » Soil Usage: 1 ft<sup>3</sup>
- » GPM: 7-10

### 31" Bowl OPT-31RPW

- » Size: 31"
- » Height: 10"
- » Base: 10"
- » Scupper: 8"
- » Soil Usage: 2 ft<sup>3</sup>
- » GPM: 7-10

### 36" Bowl OPT-36RPW

- » Size: 36"
- » Height: 12"
- » Base: 14"
- » Scupper: 8"
- » Soil Usage: 3 ft<sup>3</sup>
- » GPM: 7-10

### 48" Bowl OPT-48RPW

- » Size: 48"
- » Height: 16"
- » Base: 20"
- » Scupper: 8"
- » Soil Usage: 1 ft<sup>3</sup>
- » GPM: 7-10



24" BROWN

## Cazo Water Bowl

Includes: Bowl, Copper Spillway, & Smooth Flow Water Fitting (1 ½" Inlet)

### 24" Bowl OPT-24RWO

- » Size: 24"
- » Height: 9"
- » Base: 9"
- » Scupper: 8"
- » GPM: 7-10

### 31" Bowl OPT-31RWO

- » Size: 31"
- » Height: 10"
- » Base: 10"
- » Scupper: 8"
- » GPM: 7-10

### 36" Bowl OPT-36RWO

- » Size: 36"
- » Height: 12"
- » Base: 14"
- » Scupper: 8"
- » GPM: 7-10

### 48" Bowl OPT-48RWO

- » Size: 48"
- » Height: 16"
- » Base: 20"
- » Scupper: 8"
- » GPM: 7-10



24" NATURAL GRAY



### All Water Bowls Include The Easy Flow Fitting

All Water Bowls come with easy-flow water fitting that accommodates a 1 ½" water line



### Key Valve Upgrade

OPT-KVI

Installed Onto Bowl: Key Valve, Installation Bracket, & Gas Hoses

### Optional Cazo Canvas Cover

24" Cover - OPT-BCVR-24R  
31" Cover - OPT-BCVR-32R  
36" Cover - OPT-BCVR-36R  
48" Cover - OPT-BCVR-48R

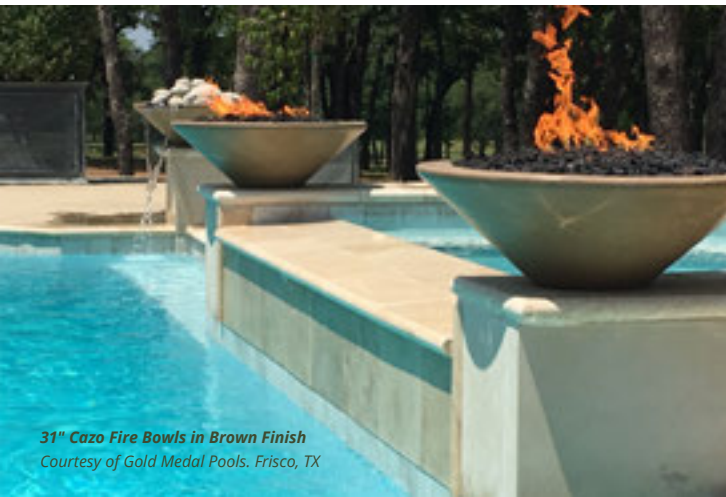

31" Cazo Fire Bowls in Brown Finish  
Courtesy of Gold Medal Pools. Frisco, TX



31" Cazo Fire Bowls in Brown Finish — Courtesy of Horner Xpress

# CAZO CONCRETE BOWLS



24" GRAY

## Cazo Fire Bowl

Includes: Bowl, Fire Pan, Burner, Whistle Free Hose, Gas Orifice, Mounting Bracket, Lava Rock. (3" Opening)

### 24" Bowl

OPT-24RFO  
OPT-24RFOE12V

- » Size: 24"
- » Height: 9"
- » Base: 9"
- » Burner: 8"
- » BTU: 45K
- » Sugg. Glass: 40 lbs.

### 31" Bowl

OPT-31RFO  
OPT-31RFOE12V

- » Size: 31"
- » Height: 10"
- » Base: 10"
- » Burner: 12"
- » BTU: 65K
- » Sugg. Glass: 55lbs.

### 36" Bowl

OPT-36RFO  
OPT-36RFOE12V

- » Size: 36"
- » Height: 12"
- » Base: 14"
- » Burner: 12"
- » BTU: 65K
- » Sugg. Glass: 95 lbs.

### 48" Bowl

OPT-48RFO  
OPT-48RFOE12V

- » Size: 48"
- » Height: 16"
- » Base: 20"
- » Burner: 18"
- » BTU: 65K
- » Sugg. Glass: 200 lbs.



24" BLACK

## Cazo Fire & Water Bowl

Includes: Bowl, Copper Scupper (¾" Inlet) Fire Pan, Burner, Whistle Free Hose, Gas Orifice, Mounting Bracket, Lava Rock. (3" Opening)

### 24" Bowl

OPT-24RFW  
OPT-24RFWE12V

- » Size: 24"
- » Height: 9"
- » Base: 9"
- » Burner: 8"
- » BTU: 45K
- » Sugg. Glass: 40 lbs.
- » GPM: 7-10.

### 31" Bowl

OPT-31RFW  
OPT-31RFWE12V

- » Size: 31"
- » Height: 10"
- » Base: 10"
- » Burner: 12"
- » BTU: 65K
- » Sugg. Glass: 55lbs.
- » GPM: 7-10.

### 36" Bowl

OPT-36RFW  
OPT-36RFWE12V

- » Size: 36"
- » Height: 12"
- » Base: 14"
- » Burner: 12"
- » BTU: 65K
- » Sugg. Glass: 95 lbs.
- » GPM: 7-10.

### 48" Bowl

OPT-48RFW  
OPT-48RFWE12V

- » Size: 48"
- » Height: 16"
- » Base: 20"
- » Burner: 18"
- » BTU: 65K
- » Sugg. Glass: 200 lbs.
- » GPM: 7-10.



48" GRAY

## 48" Cazo GFRC Fire & Water Bowl 360° Spill

Includes: Bowl, Fire Pan, Burner, Whistle Free Hose, Gas Orifice, Mounting Bracket, Lava Rock. (1 ½" Water Inlet)

OPT-48CZFW360  
OPT-48CZFW360E12V

- » Size: 48"
- » Height: 17"
- » Base: 20"
- » Burner: 8"
- » BTU: 65K
- » Sugg. Glass: 25 lbs.
- » GPM: 40

When ordering, specify the concrete color by adding the color code to the end of the Part #. Example: 27" Brown Sedona Water Bowl = OPT-27RWO-BRN  
Metallic Finishes and Rustic Finishes are available at an extra charge

<b>Black</b> -BLK	<b>Ash</b> -ASH	<b>Natural Gray</b> -NGY	<b>Gray</b> -GRY	<b>White Limestone</b> -LIM	<b>Chocolate</b> -CHC	<b>Chestnut</b> -CST	<b>Brown</b> -BRN	<b>Vanilla</b> -VAN
<b>Rustic Gray</b> -RGR	<b>Moss Stone</b> -RMS	<b>Rustic White</b> -RWH	<b>Coffee</b> -RCF	<b>Slate</b> -MSL	<b>Silver</b> -MSV	<b>Pearl</b> -MPR	<b>Bronze</b> -MBR	<b>Copper</b> -MCP

# SEDONA CONCRETE BOWLS

## Planter Bowl

Includes: Bowl Only  
(Soil and plants not included.) (3" Opening)

**27" Bowl**  
OPT-27RP

- » Size: 27"
- » Height: 10"
- » Base: 12"
- » Soil Usage: 1.5 ft<sup>3</sup>

**33" Bowl**  
OPT-33RP

- » Size: 33"
- » Height: 11"
- » Base: 18"
- » Soil Usage: 2.5 ft<sup>3</sup>



27" CHOCOLATE

## Planter & Water Bowl

Includes: Bowl, Copper Scupper (¾" Inlet) (3" Opening)  
(Soil and plants not included)

**27" Bowl**  
OPT-27RPW

- » Size: 27"
- » Height: 10"
- » Base: 12"
- » Scupper: 8"
- » Soil Usage: 1.5 ft<sup>3</sup>
- » GPM: 7-10

**33" Bowl**  
OPT-33RPW

- » Size: 33"
- » Height: 11"
- » Base: 18"
- » Scupper: 8"
- » Soil Usage: 2.5 ft<sup>3</sup>
- » GPM: 7-10



27" BROWN



27" LIMESTONE

## Sedona Water Bowl

Includes: Bowl, Copper Spillway, &  
Smooth Flow Water Fitting (1 ½" Inlet)

**27" Bowl**  
OPT-27RWO

- » Size: 27"
- » Height: 10"
- » Base: 12"
- » Scupper: 8"
- » GPM: 7-10

**33" Bowl**  
OPT-33RWO

- » Size: 33"
- » Height: 11"
- » Base: 18"
- » Scupper: 8"
- » GPM: 7-10

## Sedona Fire Bowl

Includes: Bowl, Fire Pan, Burner, Whistle Free Hose,  
Gas Orifice, Mounting Bracket, Lava Rock. (3" Opening)

**27" Bowl**  
OPT-27RFO  
OPT-27RFOE12V

- » Size: 27"
- » Height: 10"
- » Base: 12"
- » Burner: 8"
- » BTU: 45K
- » Sugg. Glass: 50 lbs.

**33" Bowl**  
OPT-33RFO  
OPT-33RFOE12V

- » Size: 33"
- » Height: 11"
- » Base: 18"
- » Burner: 12"
- » BTU: 65K
- » Sugg. Glass: 75lbs.

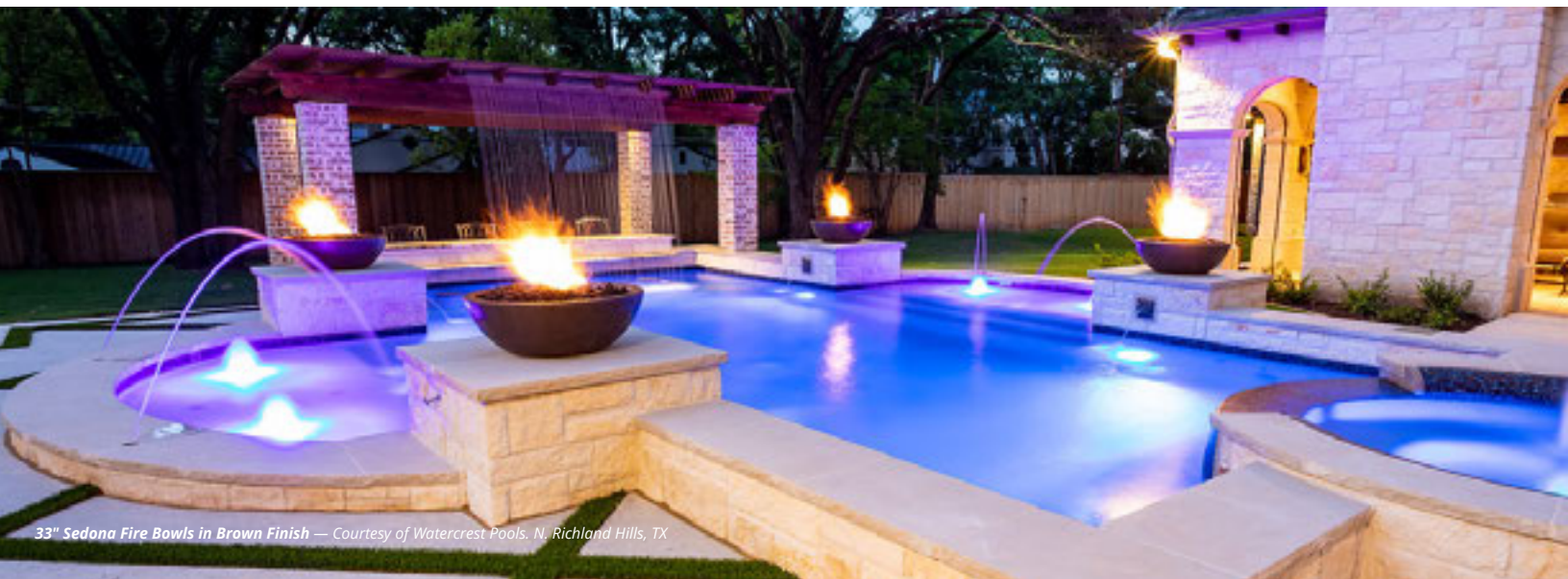

33" Sedona Fire Bowls in Brown Finish — Courtesy of Watercrest Pools, N. Richland Hills, TX

# SEDONA CONCRETE BOWLS



27" CHESTNUT

## Sedona Fire & Water Bowl

Includes: Bowl, Copper Scupper (¾" Inlet) Fire Pan, Burner, Whistle Free Hose, Gas Orifice, Mounting Bracket, Lava Rock. (3" Opening)

**27" Bowl**  
OPT-27RFW  
OPT-27RFWE12V

- » Size: 27"
- » Height: 10"
- » Base: 12"
- » Burner: 8"
- » BTU: 45K
- » Sugg. Glass: 50 lbs.
- » GPM: 7-10

**33" Bowl**  
OPT-33RFW  
OPT-33RFWE12V

- » Size: 33"
- » Height: 11"
- » Base: 18"
- » Burner: 12"
- » BTU: 65K
- » Sugg. Glass: 75lbs.
- » GPM: 7-10



46" BLACK

## Sedona Fire & Water Bowl – 4-Way Spill

Includes: Bowl, Fire Pan, Burner, Whistle Free Hose, Gas Orifice, Mounting Bracket, Lava Rock. (1 ½" Water Inlet)

**46" Bowl**  
OPT-46RFW4W  
OPT-46RFW4WE12V

- » Size: 46"
- » Height: 16"
- » Base: 24"
- » Burner: 18"
- » BTU: 65K
- » Sugg. Glass: 50 lbs.
- » GPM: 40

**60" Bowl**  
OPT-60RFW4W  
OPT-60RFW4WE12V

- » Size: 60"
- » Height: 15"
- » Base: 38"
- » Burner: 18"
- » BTU: 65K
- » Sugg. Glass: 50 lbs.
- » GPM: 40



38" GRAY

## 38" Sedona Fire & Water Bowl – 360° Spill

Includes: Bowl, Fire Pan, Burner, Whistle Free Hose, Gas Orifice, Mounting Bracket, Lava Rock. (1 ½" Water Inlet)

OPT-38FW360  
OPT-38FW360E12V

- » Size: 38"
- » Height: 16"
- » Base: 18"
- » Burner: 8"
- » BTU: 45K
- » Sugg. Glass: 16lbs.
- » GPM: 40



### All Water Bowls Include The Easy Flow Fitting

All Water Bowls come with easy-flow water fitting that accommodates a 1 ½" water line



### Key Valve Upgrade

OPT-KVI

Installed Onto Bowl: Key Valve, Installation Bracket, & Gas Hoses

### Optional Sedona Canvas Cover

27" Cover - OPT-BCVR-27R  
33" Cover - OPT-BCVR-33R  
38" Cover - OPT-BCVR-38R  
48" Cover - OPT-BCVR-38R

# LUNA CONCRETE BOWLS



30" LIMESTONE

## Luna Planter Bowl

Includes: Bowl Only  
(Soil and plants not included.) (3" Opening)

**30" Bowl**  
OPT-LUNPO30

- » Size: 30"
- » Height: 15"
- » Base: 14"
- » Soil Usage: 3 ft<sup>3</sup>

**38" Bowl**  
OPT-LUNPO38

- » Size: 38"
- » Height: 16"
- » Base: 20"
- » Soil Usage: 5.75 ft<sup>3</sup>



38" NATURAL GRAY

## Luna Planter & Water Bowl

Includes: Bowl, Copper Scupper (¾" Inlet) (3" Opening)  
(Soil and plants not included)

**30" Bowl**  
OPT-LUNPW30

- » Size: 30"
- » Height: 15"
- » Base: 14"
- » Soil Usage: 3 ft<sup>3</sup>
- » Scupper: 8"
- » GPM: 7-10

**38" Bowl**  
OPT-LUNPW38

- » Size: 38"
- » Height: 16"
- » Base: 20"
- » Soil Usage: 5.75 ft<sup>3</sup>
- » Scupper: 8"
- » GPM: 7-10



### All Water Bowls Include The Easy Flow Fitting

All Water Bowls come with easy-flow water fitting that accommodates a 1 ½" water line



### Key Valve Upgrade

OPT-KVI

Installed Onto Bowl: Key Valve, Installation Bracket, & Gas Hoses

### Optional Luna Canvas Cover

30" Cover - OPT-BCVR-30R  
38" Cover - OPT-BCVR-38R

# LUNA CONCRETE BOWLS



30" LIMESTONE

## Luna Water Bowl

Includes: Bowl, Copper Spillway, & Smooth Flow Water Fitting (1 1/2" Inlet)

### 30" Bowl

OPT-LUNWO30

- » Size: 30"
- » Height: 15"
- » Base: 14"
- » GPM: 7-10

### 38" Bowl

OPT-LUNWO38

- » Size: 38"
- » Height: 16"
- » Base: 22"
- » GPM: 7-10



30" BROWN

## Luna Fire Bowl

Includes: Bowl, Fire Pan, Burner, Whistle Free Hose, Gas Orifice, Mounting Bracket, Lava Rock. (3" Opening)

### 30" Bowl

OPT-LUNFO30

OPT-LUNFO30E12V

- » Size: 30"
- » Height: 15"
- » Base: 14"
- » Burner: 8"
- » BTU: 45K
- » Sugg. Glass: 50lbs.

### 38" Bowl

OPT-LUNFO38

OPT-LUNFO38E12V

- » Size: 38"
- » Height: 16"
- » Base: 22"
- » Burner: 12"
- » BTU: 65K
- » Sugg. Glass: 100 lbs.



30" CHESTNUT

## Luna Fire & Water Bowl

Includes: Bowl, Copper Scupper (3/4" Inlet) Fire Pan, Burner, Whistle Free Hose, Gas Orifice, Mounting Bracket, Lava Rock. (3" Opening)

### 30" Bowl

OPT-LUNFW30

OPT-LUNFW30E12V

- » Size: 30"
- » Height: 15"
- » Base: 14"
- » Burner: 8"
- » BTU: 45K
- » Sugg. Glass: 50lbs.
- » GPM: 7-10

### 38" Bowl

OPT-LUNFW38

OPT-LUNFW38E12V

- » Size: 38"
- » Height: 16"
- » Base: 22"
- » Burner: 12"
- » BTU: 65K
- » Sugg. Glass: 100 lbs.
- » GPM: 7-10

When ordering, specify the concrete color by adding the color code to the end of the Part #. Example: 27" Brown Sedona Water Bowl = OPT-27RWO-BRN  
Metallic Finishes and Rustic Finishes are available at an extra charge

<b>Black</b> -BLK	<b>Ash</b> -ASH	<b>Natural Gray</b> -NGY	<b>Gray</b> -GRY	<b>White Limestone</b> -LIM	<b>Chocolate</b> -CHC	<b>Chestnut</b> -CST	<b>Brown</b> -BRN	<b>Vanilla</b> -VAN
<b>Rustic Gray</b> -RGR	<b>Moss Stone</b> -RMS	<b>Rustic White</b> -RWH	<b>Coffee</b> -RCF	<b>Slate</b> -MSL	<b>Silver</b> -MSV	<b>Pearl</b> -MPR	<b>Bronze</b> -MBR	<b>Copper</b> -MCP



24" LIMESTONE

## Maya Planter Bowl

Includes: Bowl Only (Soil and plants not included.) (3" Opening)

### 24" Bowl OPT-24SP

- » Size: 24"
- » Height: 10 ¾"
- » Base: 13"
- » Soil Usage: 1 ft³

### 30" Bowl OPT-30SP

- » Size: 30"
- » Height: 10 ¼"
- » Base: 13"
- » Soil Usage: 2 ft³

### 36" Bowl OPT-36SP

- » Size: 36"
- » Height: 12"
- » Base: 20"
- » Soil Usage: 2 ft³



24" CHESTNUT

## Maya Planter & Water Bowl

Includes: Bowl, Copper Scupper (¾" Inlet) (3" Opening)  
(Soil and plants not included)

### 24" Bowl OPT-24SPW

- » Size: 24"
- » Height: 10 ¾"
- » Base: 13"
- » Soil Usage: 1 ft³
- » Scupper: 8"
- » GPM: 7-10

### 30" Bowl OPT-30SPW

- » Size: 30"
- » Height: 10 ¼"
- » Base: 13"
- » Soil Usage: 2 ft³
- » Scupper: 8"
- » GPM: 7-10

### 36" Bowl OPT-36SPW

- » Size: 36"
- » Height: 12"
- » Base: 20"
- » Soil Usage: 2 ft³
- » Scupper: 12"
- » GPM: 7-10



30" BLACK

## Maya Water Bowl

Includes: Bowl, Copper Spillway, &  
Smooth Flow Water Fitting (1 ½" Inlet)

### 24" Bowl OPT-24SWO

- » Size: 24"
- » Height: 10 ¾"
- » Base: 13"
- » Scupper: 8"
- » GPM: 7-10

### 30" Bowl OPT-30SWO

- » Size: 30"
- » Height: 10 ¼"
- » Base: 13"
- » Scupper: 8"
- » GPM: 7-10

### 36" Bowl OPT-36SWO

- » Size: 36"
- » Height: 12"
- » Base: 20"
- » Scupper: 12"
- » GPM: 7-10



30" BROWN

## Maya Fire Bowl

Includes: Bowl, Fire Pan, Burner, Whistle Free Hose, Gas  
Orifice, Mounting Bracket, Lava Rock. (3" Opening)

### 24" Bowl OPT-24SFO OPT-24SFOE12V

- » Size: 24"
- » Height: 10 ¾"
- » Base: 13"
- » Burner: 8"
- » BTU: 45K
- » Sugg. Glass: 50 lbs.

### 30" Bowl OPT-30SFO OPT-30SFOE12V

- » Size: 30"
- » Height: 10 ¼"
- » Base: 13"
- » Burner: 8"
- » BTU: 45K
- » Sugg. Glass: 50 lbs.

### 36" Bowl OPT-36SFO OPT-36SFOE12V

- » Size: 36"
- » Height: 12"
- » Base: 20"
- » Burner: 12"
- » BTU: 65K
- » Sugg. Glass: 50 lbs.



### All Water Bowls Include The Easy Flow Fitting

All Water Bowls come with easy-flow  
water fitting that accommodates a 1  
½" water line



### Key Valve Upgrade

OPT-KVI

Installed Onto Bowl: Key Valve,  
Installation Bracket, & Gas Hoses

### Optional Maya Canvas Cover

24" Cover - OPT-BCVR-2424  
30" Cover - OPT-BCVR-3030  
36" Cover - OPT-BCVR-3636  
48" x 20" Cover - OPT-CVR4820



# MAYA CONCRETE BOWLS



30" NATURAL GRAY

## Maya Fire & Water Bowl

Includes: Bowl, Copper Scupper (¾" Inlet) Fire Pan, Burner, Whistle Free Hose, Gas Orifice, Mounting Bracket, Lava Rock. (3" Opening)

**24" Bowl**  
OPT-24SFV  
OPT-24SFWE12V

- » Size: 24"
- » Height: 10.5"
- » Base: 13"
- » Burner: 8"
- » BTU: 45K
- » Sugg. Glass: 50 lbs.
- » Scupper: 8"
- » GPM: 7-10

**30" Bowl**  
OPT-30SFV  
OPT-30SFWE12V

- » Size: 30"
- » Height: 10 ¼"
- » Base: 13"
- » Burner: 8"
- » BTU: 45K
- » Sugg. Glass: 50 lbs.
- » Scupper: 8"
- » GPM: 7-10

**36" Bowl**  
OPT-36SFV  
OPT-36SFWE12V

- » Size: 36"
- » Height: 12"
- » Base: 20"
- » Burner: 12"
- » BTU: 65K
- » Sugg. Glass: 50 lbs.
- » Scupper: 10"
- » GPM: 7-10



30" BROWN

## Maya Fire & Wide Spill Water Bowl

Includes: Bowl, Copper Scupper (¾" Inlet) Fire Pan, Burner, Whistle Free Hose, Gas Orifice, Mounting Bracket, Lava Rock. (3" Opening)

**24" Bowl**  
OPT-24SFVWS  
OPT-24SFVWS12V

- » Size: 24"
- » Height: 10 ¾"
- » Base: 13"
- » Burner: 8"
- » BTU: 45K
- » Sugg. Glass: 50 lbs.
- » Scupper: 16"
- » GPM: 15

**30" Bowl**  
OPT-30SFVWS  
OPT-30SFVWS12V

- » Size: 30"
- » Height: 10 ¼"
- » Base: 13"
- » Burner: 8"
- » BTU: 45K
- » Sugg. Glass: 50 lbs.
- » Scupper: 16"
- » GPM: 15

**36" Bowl**  
OPT-36SFVWS  
OPT-36SFVWS12V

- » Size: 36"
- » Height: 12"
- » Base: 20"
- » Burner: 12"
- » BTU: 65K
- » Sugg. Glass: 50 lbs.
- » Scupper: 20"
- » GPM: 15



48" LIMESTONE

## Linear Maya Fire Bowl

Includes: Bowl, Fire Pan, Burner, Whistle Free Hose, Gas Orifice, Lava Rock.

**48" Bowl**  
OPT-4820MFO  
OPT-4820MFOE12V

- » Size: 48" x 20"
- » Height: 12"
- » Base: 38" x 10"
- » Burner: 30" Linear
- » BTU: 50K
- » Sugg. Glass: 60 lbs.



48" LIMESTONE

## Linear Maya Fire & Water

Includes: Bowl, Copper Scupper (¾" Inlet) Fire Pan, Burner, Whistle Free Hose, Gas Orifice, Lava Rock.

**48" Bowl**  
OPT-4820MFW  
OPT-4820MFW12V

- » Size: 48" x 20"
- » Height: 12"
- » Base: 38" x 10"
- » Burner: 30" Linear
- » BTU: 50K
- » Sugg. Glass: 60 lbs.
- » Scupper 36"
- » GPM: 20

# AVALON CONCRETE BOWLS



24" BLACK

## Avalon Planter Bowl

Includes: Bowl Only  
(Soil and plants not included.) (3" Opening)

**24" Bowl**  
OPT-AVLPO24

- » Size: 24"
- » Height: 10"
- » Base: 13"
- » Soil Usage: 1 ft<sup>3</sup>

**30" Bowl**  
OPT-AVLPO30

- » Size: 30"
- » Height: 12"
- » Base: 18"
- » Soil Usage: 2 ft<sup>3</sup>

**36" Bowl**  
OPT-AVLPO36

- » Size: 36"
- » Height: 12"
- » Base: 20"
- » Soil Usage: 2 ft<sup>3</sup>



24" LIMESTONE

## Avalon Planter & Water Bowl

Includes: Bowl, Copper Scupper (¾" Inlet) (3" Opening)  
(Soil and plants not included)

**24" Bowl**  
OPT-AVLPW24

- » Size: 24"
- » Height: 10"
- » Base: 13"
- » Soil Usage: 1 ft<sup>3</sup>
- » Scupper: 8"
- » GPM: 7-10

**30" Bowl**  
OPT-AVLPW30

- » Size: 30"
- » Height: 12"
- » Base: 18"
- » Soil Usage: 2 ft<sup>3</sup>
- » Scupper: 8"
- » GPM: 7-10

**36" Bowl**  
OPT-AVLPW36

- » Size: 36"
- » Height: 12"
- » Base: 20"
- » Soil Usage: 2 ft<sup>3</sup>
- » Scupper: 12"
- » GPM: 7-10



24" BROWN

## Avalon Water Bowl

Includes: Bowl, Copper Spillway, &  
Smooth Flow Water Fitting (1 ½" Inlet)

**24" Bowl**  
OPT-AVLWO24

- » Size: 24"
- » Height: 10"
- » Base: 13"
- » Scupper: 8"
- » GPM: 7-10

**30" Bowl**  
OPT-AVLWO30

- » Size: 30"
- » Height: 12"
- » Base: 18"
- » Scupper: 8"
- » GPM: 7-10

**36" Bowl**  
OPT-AVLWO36

- » Size: 36"
- » Height: 12"
- » Base: 20"
- » Scupper: 10"
- » GPM: 7-10



### All Water Bowls Include The Easy Flow Fitting

All Water Bowls come with easy-flow water fitting that accommodates a 1 ½" water line



### Key Valve Upgrade

OPT-KVI

Installed Onto Bowl: Key Valve, Installation Bracket, & Gas Hoses

### Optional Avalon Canvas Cover

24" Cover - OPT-BCVR-2424  
30" Cover - OPT-BCVR-3030  
36" Cover - OPT-BCVR-3636

# AVALON CONCRETE BOWLS



30" NATURAL GRAY

## Avalon Fire Bowl

Includes: Bowl, Fire Pan, Burner, Whistle Free Hose, Gas Orifice, Mounting Bracket, Lava Rock. (3" Opening)

### 24" Bowl

OPT-AVLFO24  
OPT-AVLFO24E12V

- » Size: 24"
- » Height: 10"
- » Base: 13"
- » Burner: 8"
- » BTU: 45K
- » Sugg. Glass: 40 lbs.

### 30" Bowl

OPT-AVLFO30  
OPT-AVLFO30E12V

- » Size: 30"
- » Height: 12"
- » Base: 18"
- » Burner: 8"
- » BTU: 45K
- » Sugg. Glass: 55 lbs.

### 36" Bowl

OPT-AVLFO36  
OPT-AVLFO36E12V

- » Size: 36"
- » Height: 12"
- » Base: 20"
- » Burner: 12"
- » BTU: 65K
- » Sugg. Glass: 95 lbs.



30" LIMESTONE

## Avalon Fire & Water Bowl

Includes: Bowl, Copper Scupper (¾" Inlet) Fire Pan, Burner, Whistle Free Hose, Gas Orifice, Mounting Bracket, Lava Rock. (3" Opening)

### 24" Bowl

OPT-AVLFW24  
OPT-AVLFW24E12V

- » Size: 24"
- » Height: 10"
- » Base: 13"
- » Burner: 8"
- » BTU: 45K
- » Sugg. Glass: 40 lbs.
- » Scupper: 8"
- » GPM: 7-10

### 30" Bowl

OPT-AVLFW30  
OPT-AVLFW30E12V

- » Size: 30"
- » Height: 12"
- » Base: 18"
- » Burner: 12"
- » BTU: 65K
- » Sugg. Glass: 55 lbs.
- » Scupper: 8"
- » GPM: 7-10

### 36" Bowl

OPT-AVLFW36  
OPT-AVLFW36E12V

- » Size: 36"
- » Height: 12"
- » Base: 20"
- » Burner: 12"
- » BTU: 65K
- » Sugg. Glass: 95 lbs.
- » Scupper: 10"
- » GPM: 7-10

When ordering, specify the concrete color by adding the color code to the end of the Part #. Example: 27" Brown Sedona Water Bowl = OPT-27RWO-BRN  
Metallic Finishes and Rustic Finishes are available at an extra charge

<b>Black</b> -BLK	<b>Ash</b> -ASH	<b>Natural Gray</b> -NGY	<b>Gray</b> -GRY	<b>White Limestone</b> -LIM	<b>Chocolate</b> -CHC	<b>Chestnut</b> -CST	<b>Brown</b> -BRN	<b>Vanilla</b> -VAN
<b>Rustic Gray</b> -RGR	<b>Moss Stone</b> -RMS	<b>Rustic White</b> -RWH	<b>Coffee</b> -RCF	<b>Slate</b> -MSL	<b>Silver</b> -MSV	<b>Pearl</b> -MPR	<b>Bronze</b> -MBR	<b>Copper</b> -MCP

The Outdoor Plus individually handcrafts all products shown here. Finishes are subject to slight texture/color variations.

**Proudly Made In The USA**

# ROMA CONCRETE BOWLS



24" VANILLA

## Roma Planter Bowl

Includes: Bowl Only  
(Soil and plants not included.) (3" Opening)

### 24" Bowl

OPT-ROMPO24

- » Size: 24"
- » Height: 10"
- » Base: 9"
- » Soil Usage: 1 ft<sup>3</sup>

### 36" Bowl

OPT-ROMPO36

- » Size: 36"
- » Height: 16"
- » Base: 18"
- » Soil Usage: 2 ft<sup>3</sup>

## Roma Planter & Water Bowl

Includes: Bowl, Copper Scupper (¾" Inlet) (14" Opening)  
(Soil and plants not included)

### 24" Bowl

OPT-ROMPW24

- » Size: 24"
- » Height: 10"
- » Base: 9"
- » Soil Usage: 1 ft<sup>3</sup>
- » Scupper: 8"
- » GPM: 7-10

### 36" Bowl

OPT-ROMPW36

- » Size: 36"
- » Height: 16"
- » Base: 18"
- » Soil Usage: 2 ft<sup>3</sup>
- » Scupper: 8"
- » GPM: 7-10



36" CHOCOLATE

## Roma Water Bowl

Includes: Bowl, Copper Spillway, &  
Smooth Flow Water Fitting (1 ½" Inlet)

### 24" Bowl

OPT-ROMWO24

- » Size: 24"
- » Height: 10"
- » Base: 9"
- » Scupper: 8"
- » GPM: 7-10

### 36" Bowl

OPT-ROMWO36

- » Size: 36"
- » Height: 16"
- » Base: 18"
- » Scupper: 8"
- » GPM: 7-10



### All Water Bowls Include The Easy Flow Fitting

All Water Bowls come with easy-flow water fitting that accommodates a 1 ½" water line



### Key Valve Upgrade

OPT-KVI

Installed Onto Bowl: Key Valve, Installation Bracket, & Gas Hoses

### Optional Roma Canvas Cover

24" Cover - OPT-BCVR-24R  
37" Cover - OPT-BCVR-37R

# ROMA CONCRETE BOWLS



36" BROWN

## Roma Fire Bowl

Includes: Bowl, Fire Pan, Burner, Whistle Free Hose, Gas Orifice, Mounting Bracket, Lava Rock. (14" Opening)

### 24" Bowl

OPT-ROMFO24  
OPT-ROMFO24E12V

- » Size: 24"
- » Height: 10"
- » Base: 9"
- » Burner: 8"
- » BTU: 45K
- » Sugg. Glass: 40 lbs.

### 36" Bowl

OPT-ROMFO36  
OPT-ROMFO36E12V

- » Size: 36"
- » Height: 16"
- » Base: 18"
- » Burner: 12"
- » BTU: 45K
- » Sugg. Glass: 55 lbs.



36" NATURAL  
GRAY

## Roma Fire & Water Bowl

Includes: Bowl, Copper Scupper (3/4" Inlet) Fire Pan, Burner, Whistle Free Hose, Gas Orifice, Mounting Bracket, Lava Rock. (14" Opening)

### 24" Bowl

OPT-ROMFW24  
OPT-ROMFW24E12V

- » Size: 24"
- » Height: 10"
- » Base: 9"
- » Burner: 8"
- » BTU: 45K
- » Sugg. Glass: 40 lbs.
- » Scupper: 8"
- » GPM: 7-10

### 36" Bowl

OPT-ROMFW36  
OPT-ROMFW36E12V

- » Size: 36"
- » Height: 16"
- » Base: 18"
- » Burner: 12"
- » BTU: 65K
- » Sugg. Glass: 55 lbs.
- » Scupper: 8"
- » GPM: 7-10

When ordering, specify the concrete color by adding the color code to the end of the Part #. Example: 27" Brown Sedona Water Bowl = OPT-27RWO-BRN  
Metallic Finishes and Rustic Finishes are available at an extra charge

<b>Black</b> -BLK	<b>Ash</b> -ASH	<b>Natural Gray</b> -NGY	<b>Gray</b> -GRY	<b>White Limestone</b> -LIM	<b>Chocolate</b> -CHC	<b>Chestnut</b> -CST	<b>Brown</b> -BRN	<b>Vanilla</b> -VAN
<b>Rustic Gray</b> -RGR	<b>Moss Stone</b> -RMS	<b>Rustic White</b> -RWH	<b>Coffee</b> -RCF	<b>Slate</b> -MSL	<b>Silver</b> -MSV	<b>Pearl</b> -MPR	<b>Bronze</b> -MBR	<b>Copper</b> -MCP

The Outdoor Plus individually handcrafts all products shown here. Finishes are subject to slight texture/color variations.

**Proudly Made In The USA**

# SEDONA BOWLS - WOOD GRAIN CONCRETE

## Sedona Water Bowl

Includes: Bowl, Copper Spillway, & Smooth Flow Water Fitting (1 1/2" Inlet)

### 27" Bowl

OPT-27RWGWO

- » Size: 27"
- » Height: 10"
- » Base: 12"
- » Scupper: 8"
- » GPM: 7-10

## Sedona Planter Bowl

Includes: Bowl Only  
(Soil and plants not included.) (3" Opening)

### 27" Bowl

OPT-27RWGWO

- » Size: 27"
- » Height: 10"
- » Base: 12"
- » Soil Usage: 1.5 ft<sup>3</sup>

## Sedona Planter & Water Bowl

Includes: Bowl, Copper Scupper (3/4" Inlet) (3" Opening)  
(Soil and plants not included)

### 27" Bowl

OPT-27RWGWP

- » Size: 27"
- » Height: 10"
- » Base: 12"
- » Soil Usage: 1.5 ft<sup>3</sup>
- » Scupper: 8"
- » GPM: 7-10



27" OAK

The Outdoor Plus individually handcrafts all products shown here. Finishes are subject to slight texture/color variations.



27" Sedona Planter & Water Bowl in Ivory Wood Grain Finish

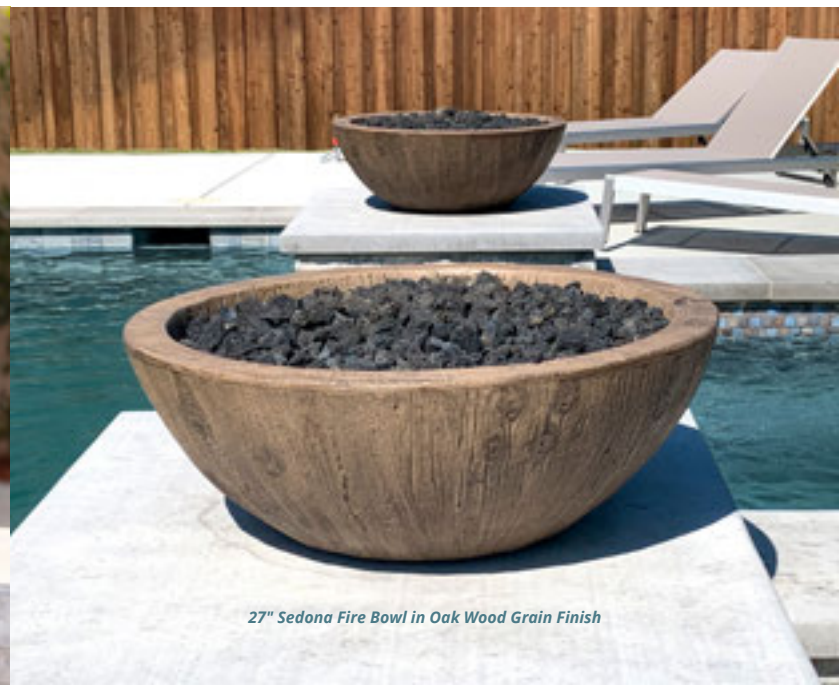

27" Sedona Fire Bowl in Oak Wood Grain Finish

# SEDONA BOWLS - WOOD GRAIN CONCRETE

## Sedona Fire Bowl

Includes: Bowl, Fire Pan, Burner, Whistle Free Hose, Gas Orifice, Mounting Bracket, Lava Rock. (3" Opening)

### 27" Bowl

OPT-27RWGFO  
OPT-27RWGFOE12V

- » Size: 27"
- » Height: 10"
- » Base: 12"
- » Burner: 8"
- » BTU: 45K
- » Sugg. Glass: 20 lbs.



27" IVORY

## Sedona Fire & Water Bowl

Includes: Bowl, Copper Scupper (¾" Inlet) Fire Pan, Burner, Whistle Free Hose, Gas Orifice, Mounting Bracket, Lava Rock. (3" Opening)

### 27" Bowl

OPT-27RWGFW  
OPT-27RWGFWE12V

- » Size: 27"
- » Height: 10"
- » Base: 12"
- » Burner: 8"
- » BTU: 45K
- » Sugg. Glass: 20 lbs.
- » Scupper: 8"
- » GPM: 7-10



27" EBONY



### GFRC WOOD GRAIN COLOR OPTIONS

When ordering, specify the color by adding the color code to the end of the Part #.  
**Example:** Coronado Fire Pit in Ivory = OPT-COR48-IVY



**All Water Bowls Include The Easy Flow Fitting**  
All Water Bowls come with easy-flow water fitting that accommodates a 1 ½" water line



**Key Valve Upgrade**  
OPT-KVI  
Installed Onto Bowl: Key Valve, Installation Bracket, & Gas Hoses

**Optional Sedona Canvas Cover**  
27" Cover - OPT-BCVR-27R

# MAYA BOWLS - WOOD GRAIN CONCRETE

## Maya Planter Bowl

Includes: Bowl Only  
(Soil and plants not included.) (3" Opening)

**24" Bowl**  
OPT-24SWGPO

- » Size: 24"
- » Height: 10.5"
- » Base: 13"
- » Soil Usage: 1.5 ft<sup>3</sup>

**30" Bowl**  
OPT-30SWGPO

- » Size: 30"
- » Height: 10.5"
- » Base: 13"
- » Soil Usage: 2 ft<sup>3</sup>

## Maya Planter & Water Bowl

Includes: Bowl, Copper Scupper (¾" Inlet) (3" Opening)  
(Soil and plants not included)

**24" Bowl**  
OPT-24SWGPPW

- » Size: 24"
- » Height: 10.5"
- » Base: 13"
- » Soil Usage: 1.5 ft<sup>3</sup>
- » Scupper: 8"
- » GPM: 7-10

**30" Bowl**  
OPT-30SWGPPW

- » Size: 30"
- » Height: 10.5"
- » Base: 13"
- » Soil Usage: 2 ft<sup>3</sup>
- » Scupper: 8"
- » GPM: 7-10



30" OAK

## Maya Water Bowl

Includes: Bowl, Copper Spillway, &  
Smooth Flow Water Fitting (1 ½" Inlet)

**24" Bowl**  
OPT-24SWGWO

- » Size: 24"
- » Height: 10.5"
- » Base: 13"
- » Scupper: 8"
- » GPM: 7-10

**30" Bowl**  
OPT-30SWGWO

- » Size: 30"
- » Height: 10.5"
- » Base: 13"
- » Scupper: 8"
- » GPM: 7-10



30" OAK

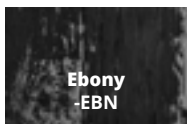

**Ebony**  
-EBN



**Ivory**  
-IVY

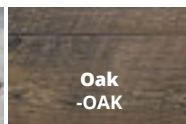

**Oak**  
-OAK

### GFRC WOOD GRAIN COLOR OPTIONS

When ordering, specify the color by adding the color code to the end of the Part #.

**Example:** Coronado Fire Pit in Ivory = OPT-COR48-IVY



# MAYA BOWLS - WOOD GRAIN CONCRETE

## Maya Fire Bowl

Includes: Bowl, Fire Pan, Burner, Whistle Free Hose, Gas Orifice, Mounting Bracket, Lava Rock. (3" Opening)

### 24" Bowl

OPT-24SWGFO  
OPT-24SWGFOE12V

- » Size: 24"
- » Height: 10.5"
- » Base: 13"
- » Burner: 8"
- » BTU: 45K
- » Sugg. Glass: 20 lbs.

### 30" Bowl

OPT-30SWGFO  
OPT-30SWGFOE12V

- » Size: 30"
- » Height: 10.5"
- » Base: 13"
- » Burner: 8"
- » BTU: 45K
- » Sugg. Glass: 20 lbs.



30" EBONY

## Maya Fire & Water Bowl

Includes: Bowl, Copper Scupper (3/4" Inlet) Fire Pan, Burner, Whistle Free Hose, Gas Orifice, Mounting Bracket, Lava Rock. (3" Opening)

### 24" Bowl

OPT-24SWGFW  
OPT-24SWGFWWE12V

- » Size: 24"
- » Height: 10.5"
- » Base: 13"
- » Burner: 8"
- » BTU: 45K
- » Sugg. Glass: 20 lbs.
- » Scupper: 8"
- » GPM: 7-10

### 30" Bowl

OPT-30SWGFW  
OPT-30SWGFWWE12V

- » Size: 30"
- » Height: 10.5"
- » Base: 13"
- » Burner: 8"
- » BTU: 45K
- » Sugg. Glass: 20 lbs.
- » Scupper: 8"
- » GPM: 7-10



30" IVORY

## Maya Fire & Wide Spill Water Bowl

Includes: Bowl, Copper Scupper (3/4" Inlet) Fire Pan, Burner, Whistle Free Hose, Gas Orifice, Mounting Bracket, Lava Rock. (3" Opening)

### 24" Bowl

OPT-24SWGFWWS  
OPT-24SWGFWWSE12V

- » Size: 24"
- » Height: 10.5"
- » Base: 13"
- » Burner: 8"
- » BTU: 45K
- » Sugg. Glass: 20 lbs.
- » Scupper: 8"
- » GPM: 15

### 30" Bowl

OPT-30SWGFWWS  
OPT-30SWGFWWSE12V

- » Size: 30"
- » Height: 10.5"
- » Base: 13"
- » Burner: 8"
- » BTU: 45K
- » Sugg. Glass: 20 lbs.
- » Scupper: 8"
- » GPM: 15



24" IVORY



### All Water Bowls Include The Easy Flow Fitting

All Water Bowls come with easy-flow water fitting that accommodates a 1 1/2" water line



### Key Valve Upgrade

OPT-KVI

Installed Onto Bowl: Key Valve, Installation Bracket, & Gas Hoses

### Optional Maya Canvas Cover

24" Cover - OPT-BCVR-2424  
30" Cover - OPT-BCVR-3030

## Cazo Planter Bowl

Includes: Bowl Only  
(Soil and plants not included.) (3" Opening)

### 24" Bowl

OPT-24RWGPO

- » Size: 24"
- » Height: 8"
- » Base: 12"
- » Soil Usage: 1.5 ft<sup>3</sup>

### 32" Bowl

OPT-32RWGPO

- » Size: 32"
- » Height: 11"
- » Base: 12"
- » Soil Usage: 2 ft<sup>3</sup>



32" EBONY

## Cazo Planter & Water Bowl

Includes: Bowl, Copper Scupper (¾" Inlet) (3" Opening)  
(Soil and plants not included)

### 24" Bowl

OPT-24RWGPW

- » Size: 24"
- » Height: 8"
- » Base: 12"
- » Soil Usage: 1.5 ft<sup>3</sup>
- » Scupper: 8"
- » GPM: 7-10

### 32" Bowl

OPT-32RWGPW

- » Size: 32"
- » Height: 11"
- » Base: 12"
- » Soil Usage: 2 ft<sup>3</sup>
- » Scupper: 8"
- » GPM: 7-10

## Cazo Water Bowl

Includes: Bowl, Copper Spillway, &  
Smooth Flow Water Fitting (1 ½" Inlet)

### 24" Bowl

OPT-24RWGWO

- » Size: 24"
- » Height: 8"
- » Base: 12"
- » Scupper: 8"
- » GPM: 7-10

### 32" Bowl

OPT-32RWGWO

- » Size: 32"
- » Height: 10"
- » Base: 12"
- » Scupper: 8"
- » GPM: 7-10



32" IVORY



### GFRC WOOD GRAIN COLOR OPTIONS

When ordering, specify the color by adding the color code to the end of the Part #.  
**Example:** Coronado Fire Pit in Ivory = OPT-COR48-IVY

# CAZO BOWLS - WOOD GRAIN CONCRETE

## Cazo Fire Bowl

Includes: Bowl, Fire Pan, Burner, Whistle Free Hose, Gas Orifice, Mounting Bracket, Lava Rock. (3" Opening)

### 24" Bowl

OPT-24RWGFO  
OPT-24RWGFOE12V

- » Size: 24"
- » Height: 8"
- » Base: 12"
- » Burner: 8"
- » BTU: 45K
- » Sugg. Glass: 20 lbs.

### 32" Bowl

OPT-32RWGFO  
OPT-32RWGFOE12V

- » Size: 32"
- » Height: 10"
- » Base: 12"
- » Burner: 8"
- » BTU: 45K
- » Sugg. Glass: 20 lbs.



32" OAK

## Cazo Fire & Water Bowl

Includes: Bowl, Copper Scupper (¾" Inlet) Fire Pan, Burner, Whistle Free Hose, Gas Orifice, Mounting Bracket, Lava Rock. (3" Opening)

### 24" Bowl

OPT-24RWGFW  
OPT-24RWGFWWE12V

- » Size: 24"
- » Height: 8"
- » Base: 12"
- » Burner: 8"
- » BTU: 45K
- » Sugg. Glass: 20 lbs.
- » Scupper: 8"
- » GPM: 7-10

### 32" Bowl

OPT-32RWGFW  
OPT-32RWGFWWE12V

- » Size: 32"
- » Height: 10"
- » Base: 12"
- » Burner: 8"
- » BTU: 45K
- » Sugg. Glass: 20 lbs.
- » Scupper: 8"
- » GPM: 7-10



32" EBONY



### All Water Bowls Include The Easy Flow Fitting

All Water Bowls come with easy-flow water fitting that accommodates a 1 ½" water line



### Key Valve Upgrade

OPT-KVI

Installed Onto Bowl: Key Valve, Installation Bracket, & Gas Hoses

### Optional Cazo Canvas Cover

24" Cover - OPT-BCVR-24R  
32" Cover - OPT-BCVR-32R

## Cazo Planter Bowl

Includes: Bowl Only  
(Soil and plants not included.) (3" Opening)



**24" Bowl**  
OPT-R24CPO

- » Size: 24"
- » Height: 10"
- » Base: 10"
- » Soil Usage: 1.25 ft<sup>3</sup>

**30" Bowl**  
OPT-R30CPO

- » Size: 30"
- » Height: 12"
- » Base: 15"
- » Soil Usage: 3 ft<sup>3</sup>

**36" Bowl**  
OPT-R36CPO

- » Size: 36"
- » Height: 12"
- » Base: 15"
- » Soil Usage: 4.5 ft<sup>3</sup>

## Cazo Planter & Water Bowl

Includes: Bowl, Copper Scupper (¾" Inlet) (3" Opening)  
(Soil and plants not included)

**24" Bowl**  
OPT-R24CPW

- » Size: 24"
- » Height: 10"
- » Base: 10"
- » Soil Usage: 1.25 ft<sup>3</sup>
- » Scupper: 8"
- » GPM: 7-10

**30" Bowl**  
OPT-R30CPW

- » Size: 30"
- » Height: 12"
- » Base: 15"
- » Soil Usage: 3 ft<sup>3</sup>
- » Scupper: 8"
- » GPM: 7-10

**36" Bowl**  
OPT-R36CPW

- » Size: 36"
- » Height: 12"
- » Base: 15"
- » Soil Usage: 4.5 ft<sup>3</sup>
- » Scupper: 10"
- » GPM: 10

## Cazo Water Bowl

Includes: Bowl, Copper Spillway  
(1 ½" Water Inlet)



**24" Bowl**  
OPT-R24CPWO

- » Size: 24"
- » Height: 10"
- » Base: 10"
- » Scupper: 8"
- » GPM: 7-10

**30" Bowl**  
OPT-R30CPWO

- » Size: 30"
- » Height: 12"
- » Base: 15"
- » Scupper: 8"
- » GPM: 7-10

**36" Bowl**  
OPT-R36CPWO

- » Size: 36"
- » Height: 12"
- » Base: 15"
- » Scupper: 12"
- » GPM: 10

## Cazo Fire Bowl

Includes: Bowl, Fire Pan, Burner, Whistle Free Hose, Gas Orifice,  
Mounting Bracket, Lava Rock. (3" Opening)



**24" Bowl**  
OPT-101-24NWF  
OPT-101-24NWF12V

- » Size: 24"
- » Height: 10"
- » Base: 10"
- » Burner: 8"
- » BTU: 45K
- » Sugg. Glass: 20 lbs.

**30" Bowl**  
OPT-102-30NWF  
OPT-102-30NWF12V

- » Size: 30"
- » Height: 12"
- » Base: 15"
- » Burner: 8"
- » BTU: 45K
- » Sugg. Glass: 35 lbs.

**36" Bowl**  
OPT-102-36NWF  
OPT-102-36NWF12V

- » Size: 36"
- » Height: 12"
- » Base: 15"
- » Burner: 12"
- » BTU: 65K
- » Sugg. Glass: 50 lbs.



### All Water Bowls Include The Easy Flow Fitting

All Water Bowls come with easy-flow water fitting that accommodates a 1 ½" water line



### Key Valve Upgrade

OPT-KVI

Installed Onto Bowl: Key Valve, Installation Bracket, & Gas Hoses

### Optional Cazo Canvas Cover

24" Cover - OPT-BCVR-24R  
30" Cover - OPT-BCVR-30R  
36" Cover - OPT-BCVR-36R

# CAZO COPPER BOWL



## Cazo Fire & Water Bowl

Includes: Bowl, Copper Scupper (¾" Inlet) Fire Pan, Burner, Whistle Free Hose, Gas Orifice, Mounting Bracket, Lava Rock. (3" Opening)

### 24" Bowl

OPT-101-24NWCB  
OPT-101-24NWCBE12V

- » Size: 24"
- » Height: 10"
- » Base: 10"
- » Burner: 8"
- » BTU: 45K
- » Sugg. Glass: 20 lbs.
- » Scupper: 8"
- » GPM: 7-10

### 30" Bowl

OPT-102-30NWCB  
OPT-102-30NWCBE12V

- » Size: 30"
- » Height: 12"
- » Base: 15"
- » Burner: 8"
- » BTU: 45K
- » Sugg. Glass: 35 lbs.
- » Scupper: 8"
- » GPM: 7-10

### 36" Bowl

OPT-102-36NWCB  
OPT-102-36NWCBE12V

- » Size: 36"
- » Height: 12"
- » Base: 15"
- » Burner: 12"
- » BTU: 65K
- » Sugg. Glass: 50 lbs.
- » Scupper: 8"
- » GPM: 7-10



## Cazo Fire & Water Bowl, 4-Way Spill

Includes: Bowl, Fire Pan, Burner, Whistle Free Hose, Gas Orifice, Lava Rock. (1 ½" Water Inlet)

### 30" Bowl

OPT-4W30  
OPT-4W30E12V

- » Size: 30"
- » Height: 12"
- » Base: 16"
- » Burner: 12"
- » BTU: 65K
- » Sugg. Glass: 40 lbs.
- » Scupper: 8"
- » GPM: 30
- » Water Inlet: 1 ½"

### 36" Bowl

OPT-4W36  
OPT-4W36E12V

- » Size: 36"
- » Height: 12"
- » Base: 20"
- » Burner: 12"
- » BTU: 65K
- » Sugg. Glass: 55 lbs.
- » Scupper: 8"
- » GPM: 30
- » Water Inlet: 1 ½"

## Cazo Fire & Water Bowl- 360° Spill

Includes: Bowl, Fire Pan, Burner, Whistle Free Hose, Gas Orifice, Lava Rock. (1 ½" Water Inlet)

### 30" Bowl

OPT-30FW360  
OPT-30FW360E12V

- » Size: 30"
- » Height: 13.5"
- » Base: 16"
- » Burner: 6"
- » BTU: 45K
- » Sugg. Glass: 35 lbs.
- » GPM: 15
- » Water Inlet: 1 ½"

### 36" Bowl

OPT-36FW360  
OPT-36FW360E12V

- » Size: 36"
- » Height: 13.5"
- » Base: 20"
- » Burner: 8"
- » BTU: 45K
- » Sugg. Glass: 35 lbs.
- » GPM: 15
- » Water Inlet: 1 ½"



30" Cazo Fire & Water Bowl, 4-Way Spill - OPT-4W30  
Courtesy of Pool Logic Design & Construction, CA

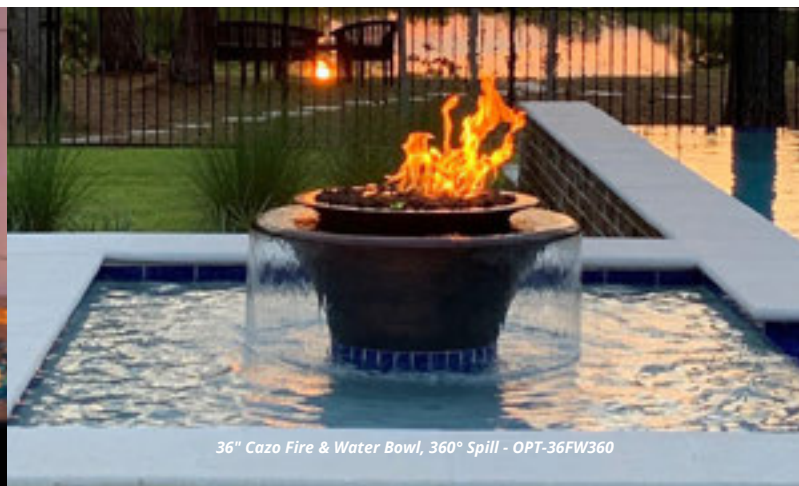

36" Cazo Fire & Water Bowl, 360° Spill - OPT-36FW360



## Sedona Planter Bowl

Includes: Bowl Only  
(Soil and plants not included.) (3" Opening)

### 27" Bowl

OPT-27RCRPO

- » Size: 27"
- » Height: 10"
- » Base: 12"
- » Soil Usage: 1.5 ft<sup>3</sup>

## Sedona Planter & Water Bowl

Includes: Bowl, Copper Scupper (¾" Inlet) (3" Opening)  
(Soil and plants not included)

### 27" Bowl

OPT-27RCRPW

- » Size: 27"
- » Height: 10"
- » Base: 12"
- » Soil Usage: 1.5 ft<sup>3</sup>
- » Scupper: 8"
- » GPM: 7-10



## Sedona Water Bowl

Includes: Bowl, Copper Spillway  
(1 ½" Water Inlet)

### 27" Bowl

OPT-27RCPRWO

- » Size: 27"
- » Height: 10"
- » Base: 12"
- » Scupper: 8"
- » GPM: 7-10



## Sedona Fire Bowl

Includes: Bowl, Fire Pan, Burner, Whistle Free Hose,  
Gas Orifice, Mounting Bracket, Lava Rock. (3" Opening)

### 27" Bowl

OPT-27RCPRFO  
OPT-27RCPRFOE12V

- » Size: 27"
- » Height: 10"
- » Base: 12"
- » Burner: 8"
- » BTU: 45K
- » Sugg. Glass: 20 lbs.



### All Water Bowls Include The Easy Flow Fitting

All Water Bowls come with easy-flow  
water fitting that accommodates a 1 ½"  
water line



### Key Valve Upgrade

OPT-KVI

Installed Onto Bowl: Key Valve,  
Installation Bracket, & Gas Hoses

### Optional Sedona Canvas Cover

27" Cover - OPT-BCVR-27R

# SEDONA COPPER BOWL



## Sedona Fire & Water Bowl

Includes: Bowl, Copper Scupper (¾" Inlet) Fire Pan, Burner, Whistle Free Hose, Gas Orifice, Mounting Bracket, Lava Rock. (3" Opening)

### 27" Bowl

OPT-27RCPRFW  
OPT-27RCPRFWE12V

- » Size: 27"
- » Height: 10"
- » Base: 12"
- » Burner: 8"
- » BTU: 45K
- » Sugg. Glass: 20 lbs.
- » Scupper: 8"
- » GPM: 7-10



## Sedona Fire & Water Bowl - Gravity Spill

Includes: Bowl, Copper Scupper (¾" Inlet) Fire Pan, Burner, Whistle Free Hose, Gas Orifice, Mounting Bracket, Lava Rock. (3" Opening)

### 27" Bowl

OPT-27RCPRFWGS  
OPT-27RCPRFWGSE12V

- » Size: 27"
- » Height: 10"
- » Base: 12"
- » Burner: 8"
- » BTU: 45K
- » Sugg. Glass: 20 lbs.
- » Scupper: 8"
- » GPM: 7-10



27" Sedona Copper Fire Bowl

## Maya Planter Bowl

Includes: Bowl Only  
(Soil and plants not included.)

**24" Bowl**  
OPT-24SCPO

Size: 24"  
Height: 10"  
Base: 12"  
Soil Usage: 2 ft<sup>3</sup>

**30" Bowl**  
OPT-30SCPO

Size: 30"  
Height: 10"  
Base: 15"  
Soil Usage: 3 ft<sup>3</sup>

**36" Bowl**  
OPT-36SCPO

Size: 36"  
Height: 12"  
Base: 18"  
Soil Usage: 5.25 ft<sup>3</sup>



## Maya Planter & Water Bowl

Includes: Bowl, Copper Scupper (¾" Inlet)  
(Soil and plants not included)

**24" Bowl**  
OPT-24SCPW

Size: 24"  
Height: 10"  
Base: 12"  
Soil Usage: 2 ft<sup>3</sup>  
Scupper: 8"  
GPM: 7-10

**30" Bowl**  
OPT-30SCPW

Size: 30"  
Height: 10"  
Base: 15"  
Soil Usage: 3 ft<sup>3</sup>  
Scupper: 8"  
GPM: 7-10

**36" Bowl**  
OPT-36SCPW

Size: 36"  
Height: 12"  
Base: 18"  
Soil Usage: 5.25 ft<sup>3</sup>  
Scupper: 10"  
GPM: 7-10

## Maya Water Bowl

Includes: Bowl, Copper Spillway  
(1 ½" Water Inlet)

**24" Bowl**  
OPT-24SCW

Size: 24"  
Height: 10"  
Base: 12"  
Scupper: 8"  
GPM: 7-10

**30" Bowl**  
OPT-30SCW

Size: 30"  
Height: 10"  
Base: 15"  
Scupper: 8"  
GPM: 7-10

**36" Bowl**  
OPT-36SCW

Size: 36"  
Height: 12"  
Base: 18"  
Scupper: 10"  
GPM: 7-10



## Maya Water Bowl - Wide Spill

Includes: Bowl, Copper Spillway  
(1 ½" Water Inlet)

**24" Bowl**  
OPT-24SCXW

Size: 24"  
Height: 10"  
Base: 12"  
Scupper: 20"  
GPM: 15

**30" Bowl**  
OPT-30SCXW

Size: 30"  
Height: 10"  
Base: 15"  
Scupper: 24"  
GPM: 15

**36" Bowl**  
OPT-36SCXW

Size: 36"  
Height: 12"  
Base: 18"  
Scupper: 30"  
GPM: 15



## Maya Fire Bowl

Includes: Bowl, Fire Pan, Burner, Whistle Free Hose,  
Gas Orifice, Mounting Bracket, Lava Rock.

**24" Bowl**  
OPT-103-SQ24  
OPT-103-SQ24E12V

Size: 24"  
Height: 10"  
Base: 12"  
Burner: 8"  
BTU: 45K  
Sugg. Glass: 45 lbs.

**30" Bowl**  
OPT-103-SQ30  
OPT-103-SQ30E12V

Size: 30"  
Height: 10"  
Base: 15"  
Burner: 10"  
BTU: 65K  
Sugg. Glass: 60 lbs.

**36" Bowl**  
OPT-103-SQ36  
OPT-103-SQ36E12V

Size: 36"  
Height: 12"  
Base: 18"  
Burner: 10"  
BTU: 65K  
Sugg. Glass: 90 lbs.







## Maya Fire & Water Bowl

Includes: Bowl, Copper Scupper (¾" Inlet) Fire Pan, Burner, Whistle Free Hose, Gas Orifice, Mounting Bracket, Lava Rock.

### 24" Bowl

OPT-24SCFW  
OPT-24SCFWE12V

- » Size: 24"
- » Height: 10"
- » Base: 12"
- » Burner: 8"
- » BTU: 45K
- » Sugg. Glass: 45 lbs.
- » Scupper: 8"
- » GPM: 7-10

### 30" Bowl

OPT-30SCFW  
OPT-30SCFWE12V

- » Size: 30"
- » Height: 10"
- » Base: 15"
- » Burner: 10"
- » BTU: 65K
- » Sugg. Glass: 60 lbs.
- » Scupper: 8"
- » GPM: 7-10

### 36" Bowl

OPT-36SCFW  
OPT-36SCFWE12V

- » Size: 36"
- » Height: 12"
- » Base: 18"
- » Burner: 10"
- » BTU: 65K
- » Sugg. Glass: 90 lbs.
- » Scupper: 10"
- » GPM: 7-10



## Maya Fire & Water Bowl - Gravity Spill

Includes: Bowl, Fire Pan, Burner, Whistle Free Hose, Gas Orifice, Mounting Bracket, Lava Rock. (1 ½" Water Inlet)

### 30" Bowl

OPT-SQ30FANDW  
OPT-SQ30FANDWE12V

- » Size: 30"
- » Height: 10"
- » Base: 15"
- » Burner: 10"
- » BTU: 65K
- » Sugg. Glass: 45 lbs.
- » Scupper: 8"
- » GPM: 7-10

### 36" Bowl

OPT-SQ36FANDW  
OPT-SQ36FANDWE12V

- » Size: 36"
- » Height: 12"
- » Base: 18"
- » Burner: 10"
- » BTU: 65K
- » Sugg. Glass: 60 lbs.
- » Scupper: 10"
- » GPM: 7-10



## Maya Fire & Water Bowl - Wide Gravity Spill

Includes: Bowl, Fire Pan, Burner, Whistle Free Hose, Gas Orifice, Mounting Bracket, Lava Rock. (1 ½" Water Inlet)

### 30" Bowl

OPT-SQ30FWWS  
OPT-SQ30FWWSE12V

- » Size: 30"
- » Height: 10"
- » Base: 15"
- » Burner: 10"
- » BTU: 65K
- » Sugg. Glass: 45 lbs.
- » Scupper: 8"
- » GPM: 15

### 36" Bowl

OPT-SQ36FWWS  
OPT-SQ36FWWSE12V

- » Size: 36"
- » Height: 12"
- » Base: 18"
- » Burner: 10"
- » BTU: 65K
- » Sugg. Glass: 60 lbs.
- » Scupper: 10"
- » GPM: 15



## Maya 4-Way Fire & Water Bowl

Includes: Bowl, Fire Pan, Burner, Whistle Free Hose, Gas Orifice, Mounting Bracket, Lava Rock. (1 ½" Water Inlet)

### 30" Bowl

OPT-30FW4W  
OPT-30FW4WE12V

- » Size: 30"
- » Height: 10"
- » Base: 15"
- » Burner: 8"
- » BTU: 45K
- » Sugg. Glass: 60 lbs.
- » Scupper: 8"
- » GPM: 15

### 36" Bowl

OPT-36FW4W  
OPT-36FW4WE12V

- » Size: 36"
- » Height: 12"
- » Base: 18"
- » Burner: 10"
- » BTU: 65K
- » Sugg. Glass: 90 lbs.
- » Scupper: 10"
- » GPM: 15

### Optional Maya Canvas Cover

24" Cover - OPT-BCVR-2424  
30" Cover - OPT-BCVR-3030  
36" Cover - OPT-BCVR-3636

# MAYA & NILE COPPER BOWLS

## Linear Maya Fire Bowl

Includes: Bowl, Fire Pan, Burner, Whistle Free Hose, Gas Orifice, Mounting Bracket, Lava Rock.

### 48" Bowl

OPT-4820MCFO  
OPT-4820MCFOE12V

- » Size: 48" x 20"
- » Height: 12"
- » Base: 38" x 10"
- » Burner: 30" Linear
- » BTU: 65K
- » Sugg. Glass: 70lbs.

### 60" Bowl

OPT-6020MCFO  
OPT-6020MCFOE12V

- » Size: 60" x 20"
- » Height: 12"
- » Base: 50" x 10"
- » Burner: 42" Linear
- » BTU: 65K
- » Sugg. Glass: 95 lbs.

### 72" Bowl

OPT-7220MCFO  
OPT-7220MCFOE12V

- » Size: 72" x 20"
- » Height: 12"
- » Base: 62" x 10"
- » Burner: 54" Linear
- » BTU: 65K
- » Sugg. Glass: 110 lbs.



## Linear Maya Fire & Water Bowl

Includes: Bowl, Copper Scupper (¾" Inlet) Fire Pan, Burner, Whistle Free Hose, Gas Orifice, Mounting Bracket, Lava Rock.

### 48" Bowl

OPT-4820MCFW  
OPT-4820MCFWE12V

- » Size: 48" x 20"
- » Height: 12"
- » Base: 38" x 10"
- » Burner: 30" Linear
- » BTU: 65K
- » Sugg. Glass: 70 lbs.
- » GPM: 15

### 60" Bowl

OPT-6020MCFW  
OPT-6020MCFWE12V

- » Size: 60" x 20"
- » Height: 12"
- » Base: 50" x 10"
- » Burner: 42" Linear
- » BTU: 65K
- » Sugg. Glass: 95 lbs.
- » GPM: 15

### 72" Bowl

OPT-7220MCFW  
OPT-7220MCFWE12V

- » Size: 72" x 20"
- » Height: 12"
- » Base: 62" x 10"
- » Burner: 54" Linear
- » BTU: 65K
- » Sugg. Glass: 110 lbs.
- » GPM: 15



## Nile Fire & Water Bowl

Includes: Bowl, Copper Scupper (¾" Inlet) Fire Pan, Burner, Whistle Free Hose, Gas Orifice, Mounting Bracket, Lava Rock.

### 30" Bowl

OPT-30NLCPF  
OPT-30NLCPF12V

- » Width: 30"
- » Length: 40"
- » Height: 14"
- » Base: 16" x 12"
- » Burner: 18"
- » BTU: 30K
- » GPM: 20

### 36" Bowl

OPT-36NLCPF  
OPT-36NLCPF12V

- » Width: 36"
- » Length: 48"
- » Height: 14"
- » Base: 18" x 15"
- » Burner: 24"
- » BTU: 40K
- » GPM: 20



30" Nile Fire & Water Bowl

# 31" REMI COPPER BOWL



## Remi Planter Bowl

Includes: Bowl Only  
(Soil and plants not included.)

OPT-31RCPO

- » Size: 31"
- » Height: 11"
- » Base: 13"
- » Soil Usage: 2.5 ft<sup>3</sup>



## Remi Water Bowl

Includes: Bowl, Copper Spillway,  
(1 1/2" Water Inlet)

OPT-31RCWO

- » Size: 31"
- » Height: 11"
- » Base: 13"
- » Scupper: 10"
- » GPM: 7-10

## Remi Planter & Water Bowl

Includes: Bowl, Copper Scupper (3/4" Inlet)  
(Soil and plants not included)

OPT-31RCPW

- » Size: 31"
- » Height: 11"
- » Base: 13"
- » Soil Usage: 2.5 ft<sup>3</sup>
- » Scupper: 10"
- » GPM: 7-10



## Remi Fire Bowl

Includes: Bowl, Fire Pan, Burner, Whistle  
Free Hose, Gas Orifice, Mounting Bracket,  
Lava Rock.

OPT-31RCFO  
OPT-31RCFOE12V

- » Size: 31"
- » Height: 11"
- » Base: 13"
- » Burner: 10"
- » BTU: 45K
- » Sugg. Glass: 75 lbs.



## Remi Fire & Water Bowl

Includes: Bowl, Copper Scupper (3/4" Inlet)  
Fire Pan, Burner, Whistle Free Hose, Gas  
Orifice, Mounting Bracket, Lava Rock.

OPT-31RCFW  
OPT-31RCFWE12V

- » Size: 31"
- » Height: 11"
- » Base: 13"
- » Burner: 10"
- » BTU: 45K
- » Sugg. Glass: 75 lbs.
- » Scupper: 10"
- » GPM: 7-10



## Fire & Water Bowl - Gravity Spill

Includes: Bowl, Fire Pan, Burner, Whistle  
Free Hose, Gas Orifice, Mounting Bracket,  
Lava Rock. (1 1/2" Water Inlet)

OPT-31RCFWGS  
OPT-31RCFWGSE12V

- » Size: 31"
- » Height: 11.5"
- » Base: 13"
- » Burner: 10"
- » BTU: 45K
- » Sugg. Glass: 75 lbs.
- » Scupper: 10"
- » GPM: 7-10



**All Water Bowls Include  
The Easy Flow Fitting**

All Water Bowls come with easy-flow  
water fitting that accommodates a 1 1/2"  
water line



**Key Valve Upgrade**  
OPT-KVI

Installed Onto Bowl: Key Valve,  
Installation Bracket, & Gas Hoses

**Optional Remi  
Canvas Cover**  
31" Cover - OPT-BCVR-31R

# AVALON COPPER BOWLS



## Avalon Water Bowl

Includes: Bowl, Copper Spillway, (1 1/2" Water Inlet)

### 24" Bowl

OPT-24AVSSWO - Stainless  
OPT-24AVCPWO - Copper

- » Size: 24"
- » Height: 10"
- » Base: 12"
- » Scupper: 8"
- » GPM: 7-10

### 30" Bowl

OPT-30AVSSWO - Stainless  
OPT-30AVCPWO - Copper

- » Size: 30"
- » Height: 13"
- » Base: 15"
- » Scupper: 8"
- » GPM: 7-10

### 36" Bowl

OPT-36AVSSWO - Stainless  
OPT-36AVCPWO - Copper

- » Size: 36"
- » Height: 13"
- » Base: 18"
- » Scupper: 10"
- » GPM: 20



## Avalon Fire & Water Bowl

Includes: Bowl, Copper Scupper (3/4" Inlet) Fire Pan, Burner, Whistle Free Hose, Gas Orifice, Mounting Bracket, Lava Rock.

### 24" Bowl

OPT-24AVCPFOW - Copper  
OPT-24AVCPFWE12V - Copper  
OPT-24AVSSFW - Stainless  
OPT-24AVSSFWE12V - Stainless

- » Size: 24"
- » Height: 10"
- » Base: 12"
- » Burner: 8"
- » BTU: 45K
- » Sugg. Glass: 45 lbs.
- » GPM: 7-10

### 30" Bowl

OPT-30AVCPFOW - Copper  
OPT-30AVCPFWE12V - Copper  
OPT-30AVSSFW - Stainless  
OPT-30AVSSFWE12V - Stainless

- » Size: 30"
- » Height: 13"
- » Base: 15"
- » Burner: 10"
- » BTU: 65K
- » Sugg. Glass: 60 lbs.
- » GPM: 7-10

### 36" Bowl

OPT-36AVCPFOW - Copper  
OPT-36AVCPFWE12V - Copper  
OPT-36AVSSFW - Stainless  
OPT-36AVSSFWE12V - Stainless

- » Size: 36"
- » Height: 13"
- » Base: 18"
- » Burner: 10"
- » BTU: 65K
- » Sugg. Glass: 90 lbs.
- » GPM: 7-10



### All Water Bowls Include The Easy Flow Fitting

All Water Bowls come with easy-flow water fitting that accommodates a 1 1/2" water line



### Key Valve Upgrade

OPT-KVI

Installed Onto Bowl, Installation Bracket, & Gas Hoses

### Optional Avalon Canvas Cover

24" Cover - OPT-BCVR-2424  
30" Cover - OPT-BCVR-3030  
36" Cover - OPT-BCVR-3636



## Avalon Fire Bowl

Includes: Bowl, Fire Pan, Burner, Whistle Free Hose, Gas Orifice, Mounting Bracket, Lava Rock.

### 24" Bowl

OPT-24AVCPF - Copper  
OPT-24AVCPFE12V - Copper  
OPT-24AVSSF - Stainless  
OPT-24AVSSFE12V - Stainless

- » Size: 24"
- » Height: 10"
- » Base: 12"
- » Burner: 8"
- » BTU: 45K
- » Sugg. Glass: 45 lbs.

### 30" Bowl

OPT-30AVCPF - Copper  
OPT-30AVCPFE12V - Copper  
OPT-30AVSSF - Stainless  
OPT-30AVSSFE12V - Stainless

- » Size: 30"
- » Height: 13"
- » Base: 15"
- » Burner: 10"
- » BTU: 65K
- » Sugg. Glass: 60 lbs.

### 36" Bowl

OPT-36AVCPF - Copper  
OPT-36AVCPFE12V - Copper  
OPT-36AVSSF - Stainless  
OPT-36AVSSFE12V - Stainless

- » Size: 36"
- » Height: 13"
- » Base: 18"
- » Burner: 10"
- » BTU: 65K
- » Sugg. Glass: 90 lbs.

# CAZO BOWLS - POWDER COAT FINISH



24" WHITE

## Cazo Planter Bowl

Includes: Bowl Only  
(Soil and plants not included.)

**24" Bowl**  
OPT-R24PCPO

- » Size: 24"
- » Height: 10"
- » Base: 10"
- » Soil Usage: 1.5 ft<sup>3</sup>

**30" Bowl**  
OPT-R30PCPO

- » Size: 30"
- » Height: 12"
- » Base: 16"
- » Soil Usage: 3 ft<sup>3</sup>

**36" Bowl**  
OPT-R36PCPO

- » Size: 36"
- » Height: 12"
- » Base: 20"
- » Soil Usage: 4.5 ft<sup>3</sup>

## Cazo Planter & Water Bowl

Includes: Bowl, Copper Scupper (¾" Inlet)  
(Soil and plants not included)

**24" Bowl**  
OPT-R24PCPW

- » Size: 24"
- » Height: 10"
- » Base: 10"
- » Soil Usage: 1.5 ft<sup>3</sup>
- » Scupper: 8"
- » GPM: 7-10

**30" Bowl**  
OPT-R30PCPW

- » Size: 30"
- » Height: 12"
- » Base: 16"
- » Soil Usage: 3 ft<sup>3</sup>
- » Scupper: 8"
- » GPM: 7-10

**36" Bowl**  
OPT-R36PCPW

- » Size: 36"
- » Height: 12"
- » Base: 20"
- » Soil Usage: 4.5 ft<sup>3</sup>
- » Scupper: 10"
- » GPM: 7-10



24" SILVER VEIN

## Cazo Water Bowl

Includes: Bowl, Copper Spillway,  
(1 ½" Water Inlet)

**24" Bowl**  
OPT-24PCWO

- » Size: 24"
- » Height: 10"
- » Base: 10"
- » Scupper: 8"
- » GPM: 7-10

**30" Bowl**  
OPT-30PCWO

- » Size: 30"
- » Height: 12"
- » Base: 16"
- » Scupper: 8"
- » GPM: 7-10

**36" Bowl**  
OPT-36PCWO

- » Size: 36"
- » Height: 12"
- » Base: 20"
- » Scupper: 10"
- » GPM: 7-10

### POWDER COAT COLOR OPTIONS

When ordering, specify the concrete color by adding the color code to the end of the Part #. **Example:** 27" Brown Sedona Water Bowl = OPT-27RWO-BRN

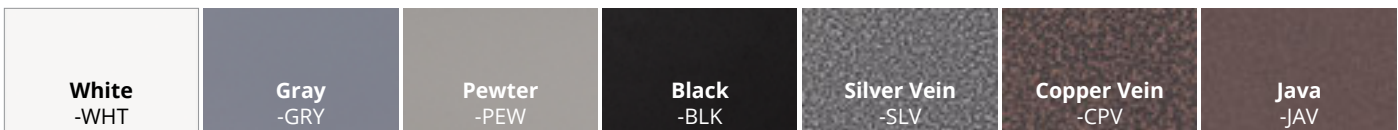

#### All Water Bowls Include The Easy Flow Fitting

All Water Bowls come with easy-flow water fitting that accommodates a 1 ½" water line



#### Key Valve Upgrade

OPT-KVI

Installed Onto Bowl: Key Valve, Installation Bracket, & Gas Hoses

#### Optional Cazo Canvas Cover

24" Cover - OPT-BCVR-24R  
30" Cover - OPT-BCVR-30R  
36" Cover - OPT-BCVR-36R

# CAZO BOWLS - POWDER COAT FINISH



24" COPPER VEIN

## Cazo Fire Bowl

Includes: Bowl, Fire Pan, Burner, Whistle Free Hose, Gas Orifice, Mounting Bracket, Lava Rock.

### 24" Bowl

OPT-R24PCFO  
OPT-R24PCFOE12V

- » Size: 24"
- » Height: 10"
- » Base: 10"
- » Burner: 8"
- » BTU: 45K
- » Sugg. Glass: 20 lbs.

### 30" Bowl

OPT-R30PCFO  
OPT-R30PCFOE12V

- » Size: 30"
- » Height: 12"
- » Base: 16"
- » Burner: 10"
- » BTU: 65K
- » Sugg. Glass: 35lbs.

### 36" Bowl

OPT-R36PCFO  
OPT-R36PCFOE12V

- » Size: 36"
- » Height: 12"
- » Base: 20"
- » Burner: 10"
- » BTU: 65K
- » Sugg. Glass: 50 lbs.



24" GRAY

## Cazo Fire & Water Bowl

Includes: Bowl, Copper Scupper (¾" Inlet) Fire Pan, Burner, Whistle Free Hose, Gas Orifice, Mounting Bracket, Lava Rock.

### 24" Bowl

OPT-R24PCFW  
OPT-R24PCFWE12V

- » Size: 24"
- » Height: 10"
- » Base: 10"
- » Burner: 8"
- » BTU: 45K
- » Sugg. Glass: 20 lbs.
- » Scupper: 8"
- » GPM: 7-10

### 30" Bowl

OPT-R30PCFW  
OPT-R30PCFWE12V

- » Size: 30"
- » Height: 12"
- » Base: 16"
- » Burner: 10"
- » BTU: 65K
- » Sugg. Glass: 35 lbs.
- » Scupper: 8"
- » GPM: 7-10

### 36" Bowl

OPT-R36PCFW  
OPT-R36PCFWE12V

- » Size: 36"
- » Height: 12"
- » Base: 20"
- » Burner: 10"
- » BTU: 65K
- » Sugg. Glass: 50 lbs.
- » Scupper: 10"
- » GPM: 7-10

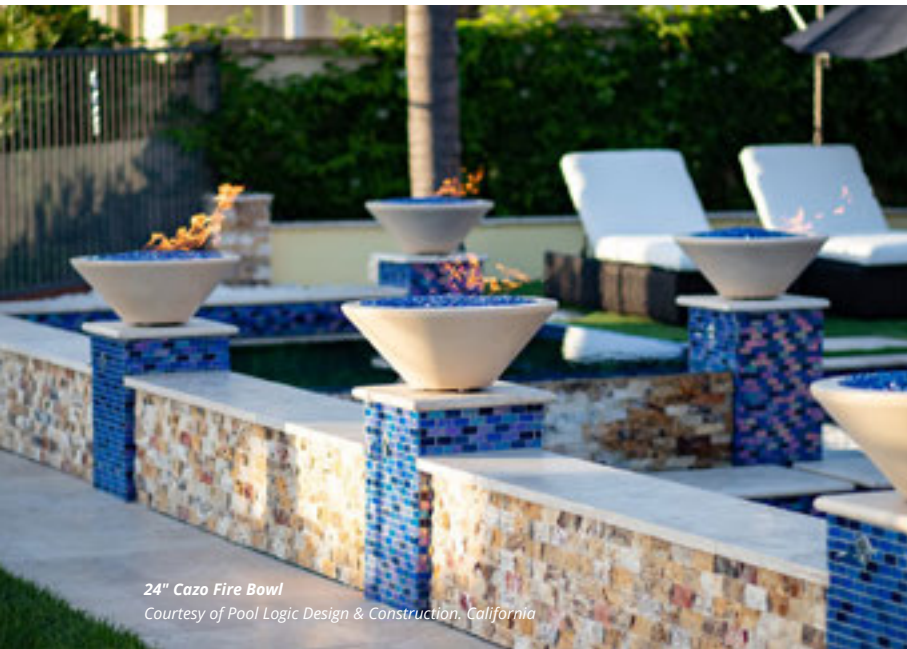

24" Cazo Fire Bowl  
Courtesy of Pool Logic Design & Construction, California

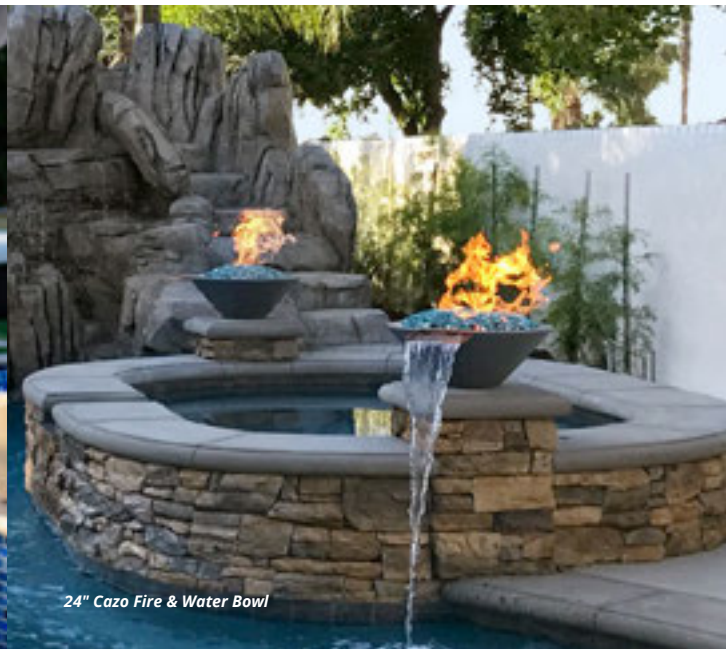

24" Cazo Fire & Water Bowl

# SEDONA BOWLS - POWDER COAT FINISH

## Sedona Planter Bowl

Includes: Bowl Only  
(Soil and plants not included.)

**27" Bowl**  
OPT-27RPCPO

- » Size: 27"
- » Height: 10"
- » Base: 12"
- » Soil Usage: 1.5 ft<sup>3</sup>



27" GRAY

## Sedona Planter & Water Bowl

Includes: Bowl, Copper Scupper (¾" Inlet)  
(Soil and plants not included)

**27" Bowl**  
OPT-27RPCPW

- » Size: 27"
- » Height: 10"
- » Base: 12"
- » Soil Usage: 1.5 ft<sup>3</sup>
- » Scupper: 8"
- » GPM: 7-10



27" BLACK

## Sedona Water Bowl

Includes: Bowl, Copper Spillway,  
(1 ½" Water Inlet)

**27" Bowl**  
OPT-27RPCWO

- » Size: 27"
- » Height: 10"
- » Base: 12"
- » Scupper: 8"
- » GPM: 7-10



27" COPPER VEIN

## Sedona Fire Bowl

Includes: Bowl, Fire Pan, Burner, Whistle Free Hose,  
Gas Orifice, Mounting Bracket, Lava Rock.

**27" Bowl**  
OPT-27RPCFO  
OPT-27RPCFOE12V

- » Size: 27"
- » Height: 10"
- » Base: 12"
- » Burner: 8"
- » BTU: 45K
- » Sugg. Glass: 20 lbs.

### POWDER COAT COLOR OPTIONS

When ordering, specify the concrete color by adding the color code to the end of the Part #. **Example:** 27" Brown Sedona Water Bowl = OPT-27RWO-BRN

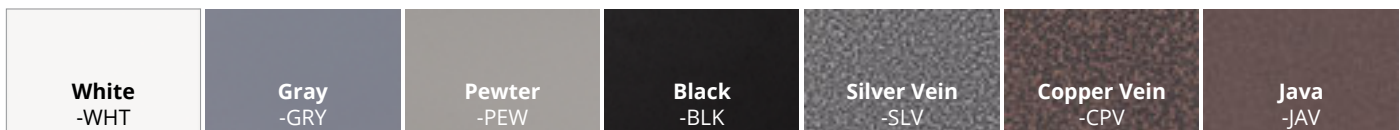



# SEDONA BOWLS - POWDER COAT FINISH



27" LIMESTONE

## Sedona Fire & Water Bowl

Includes: Bowl, Copper Scupper (3/4" Inlet) Fire Pan, Burner, Whistle Free Hose, Gas Orifice, Mounting Bracket, Lava Rock.

**27" Bowl**  
OPT-27RPCFW  
OPT-27RPCFWE12V

- » Size: 27"
- » Height: 10"
- » Base: 12"
- » Burner: 8"
- » BTU: 45K
- » Sugg. Glass: 20 lbs.
- » Scupper: 8"
- » GPM: 7-10



### All Water Bowls Include The Easy Flow Fitting

All Water Bowls come with easy-flow water fitting that accommodates a 1 1/2" water line



### Key Valve Upgrade

OPT-KVI

Installed Onto Bowl: Key Valve, Installation Bracket, & Gas Hoses

### Optional Sedona Canvas Cover

27" Cover - OPT-BCVR-27R



27" Sedona Fire Bowl in Copper Vein Finish



# MAYA BOWLS - POWDER COAT FINISH



24" GRAY

## Maya Planter Bowl

Includes: Bowl Only  
(Soil and plants not included.)

**24" Bowl**  
OPT-245QPCPO

- » Size: 24"
- » Height: 10"
- » Base: 12"
- » Soil Usage: 2 ft<sup>3</sup>

**30" Bowl**  
OPT-305QPCPO

- » Size: 30"
- » Height: 10"
- » Base: 15"
- » Soil Usage: 3 ft<sup>3</sup>

**36" Bowl**  
OPT-365QPCPO

- » Size: 36"
- » Height: 12"
- » Base: 18"
- » Soil Usage: 5.25 ft<sup>3</sup>

## Maya Planter & Water Bowl

Includes: Bowl, Copper Scupper (¾" Inlet)  
(Soil and plants not included)

**24" Bowl**  
OPT-245QPCPW

- » Size: 24"
- » Height: 10"
- » Base: 12"
- » Soil Usage: 2 ft<sup>3</sup>
- » Scupper: 8"
- » GPM: 7-10

**30" Bowl**  
OPT-305QPCPW

- » Size: 30"
- » Height: 10"
- » Base: 15"
- » Soil Usage: 3 ft<sup>3</sup>
- » Scupper: 8"
- » GPM: 7-10

**36" Bowl**  
OPT-365QPCPW

- » Size: 36"
- » Height: 12"
- » Base: 18"
- » Soil Usage: 5.25 ft<sup>3</sup>
- » Scupper: 10"
- » GPM: 7-10



24" BLACK

## Maya Water Bowl

Includes: Bowl, Copper Spillway,  
(1 ½" Water Inlet)

**24" Bowl**  
OPT-245QPCWO

- » Size: 24"
- » Height: 10"
- » Base: 12"
- » Scupper: 8"
- » GPM: 7-10

**30" Bowl**  
OPT-305QPCWO

- » Size: 30"
- » Height: 10"
- » Base: 15"
- » Scupper: 8"
- » GPM: 7-10

**36" Bowl**  
OPT-365QPCWO

- » Size: 36"
- » Height: 12"
- » Base: 18"
- » Scupper: 10"
- » GPM: 7-10

### POWDER COAT COLOR OPTIONS

When ordering, specify the concrete color by adding the color code to the end of the Part #. **Example:** 27" Brown Sedona Water Bowl = OPT-27RWO-BRN

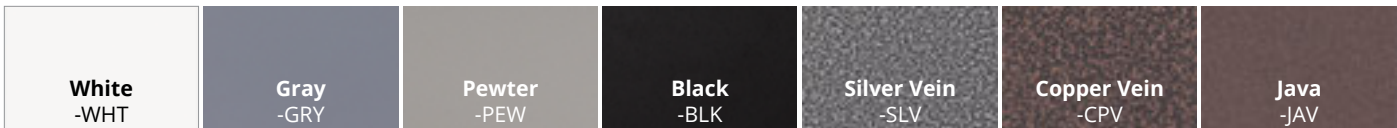

#### All Water Bowls Include The Easy Flow Fitting

All Water Bowls come with easy-flow water fitting that accommodates a 1 ½" water line



#### Key Valve Upgrade

OPT-KVI

Installed Onto Bowl; Key Valve, Installation Bracket, & Gas Hoses

#### Optional Maya Canvas Cover

24" Cover - OPT-BCVR-2424  
30" Cover - OPT-BCVR-3030  
36" Cover - OPT-BCVR-3636

# MAYA BOWLS - POWDER COAT FINISH



24" WHITE

## Maya Fire Bowl



Includes: Bowl, Fire Pan, Burner, Whistle Free Hose, Gas Orifice, Mounting Bracket, Lava Rock.

### 24" Bowl

OPT-24SQPCFO  
OPT-24SQPCFOE12V

- » Size: 24"
- » Height: 10"
- » Base: 12"
- » Burner: 8"
- » BTU: 45K
- » Sugg. Glass: 45 lbs.

### 30" Bowl

OPT-30SQPCFO  
OPT-30SQPCFOE12V

- » Size: 30"
- » Height: 10"
- » Base: 15"
- » Burner: 10"
- » BTU: 65K
- » Sugg. Glass: 60 lbs.

### 36" Bowl

OPT-36SQPCFO  
OPT-36SQPCFOE12V

- » Size: 36"
- » Height: 12"
- » Base: 18"
- » Burner: 10"
- » BTU: 65K
- » Sugg. Glass: 90 lbs.



24" COPPER  
VEIN

## Maya Fire & Water Bowl

Includes: Bowl, Copper Scupper (3/4" Inlet) Fire Pan, Burner, Whistle Free Hose, Gas Orifice, Mounting Bracket, Lava Rock.

### 24" Bowl

OPT-24SQPCFW  
OPT-24SQPCFWE12V

- » Size: 24"
- » Height: 10"
- » Base: 12"
- » Burner: 8"
- » BTU: 45K
- » Sugg. Glass: 45 lbs.
- » Scupper: 8"
- » GPM: 7-10

### 30" Bowl

OPT-30SQPCFW  
OPT-30SQPCFWE12V

- » Size: 30"
- » Height: 10"
- » Base: 15"
- » Burner: 10"
- » BTU: 65K
- » Sugg. Glass: 60 lbs.
- » Scupper: 8"
- » GPM: 7-10

### 36" Bowl

OPT-36SQPCFW  
OPT-36SQPCFWE12V

- » Size: 36"
- » Height: 12"
- » Base: 18"
- » Burner: 10"
- » BTU: 65K
- » Sugg. Glass: 90 lbs.
- » Scupper: 10"
- » GPM: 7-10

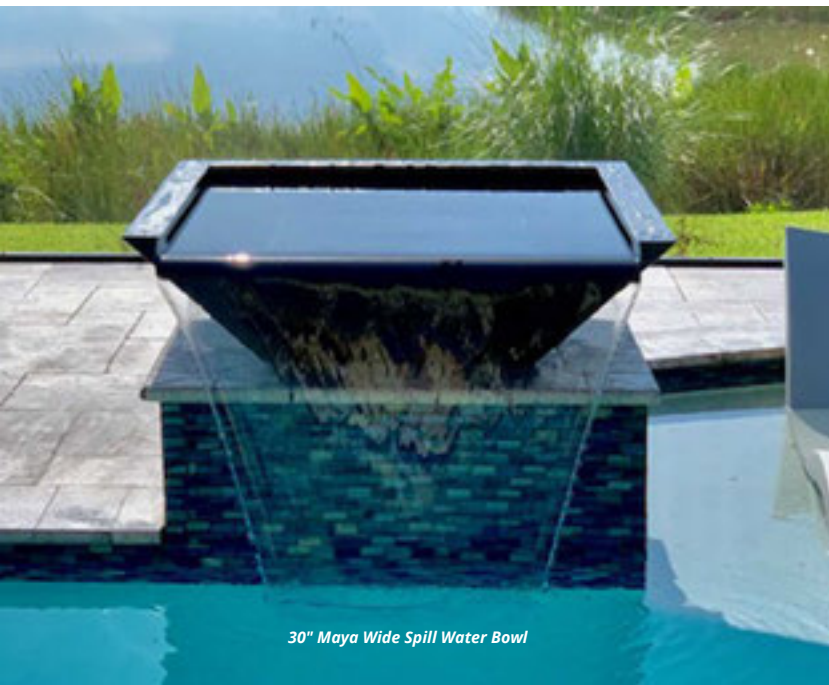

30" Maya Wide Spill Water Bowl



30" Maya Fire Bowl

# INTRODUCING THE FLAME SENSE FOR BOWLS & FIRE PITS

The Flame Sense valve is the solution for a certified match lit unit with added safety features and CSA certification. It does not require any batteries or electrical connections so installation is easier and simpler than ever. This unit is compatible with majority of T.O.P's fire features.



◇ **Thermopile Technology**

The thermopile sensors in this unit is the defining factor of safety. By using a thermopile sensor this unit will not release gas without a flame being present.

◇ **Automatic Flame Shut Off**

By using the same thermopile technology, the unit is able to sense if a flame has gone out and automatically turn itself off. This is great in case a sudden gust of wind or rainfall extinguishes your flames.

◇ **Electricity Free**

The unit does not use batteries or electrical current to operate. This makes it safe to install near bodies of water, eliminates the need to run electrical lines and eases up installation.

◇ **Easy Installation**

The valve uses two simple gas in & gas out inlets. Simply connect two gas hoses with flared fittings to get this unit running.

◇ **Weather Tested**

Proven to operate properly in mild wind, rain & snow.

◇ **Compact Construction**

The small construction allows it to be installed in tight spaces.

◇ **1 Year Limited Warranty**

Covers all components of the Electronic Ignition System

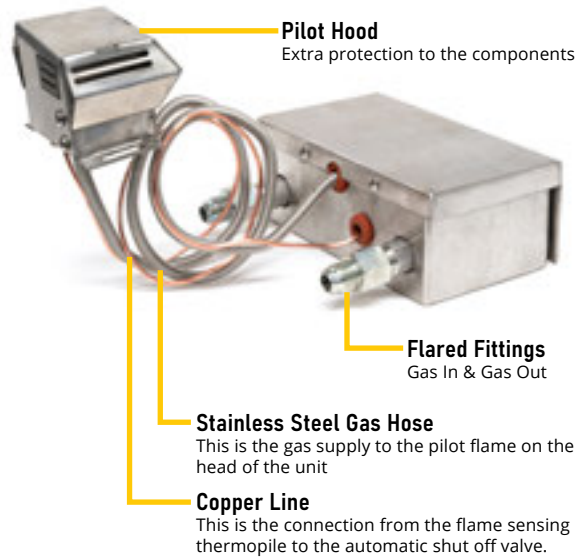

# WHAT'S INCLUDED IN YOUR BOWL?

## MATCH LIT FIRE BOWLS

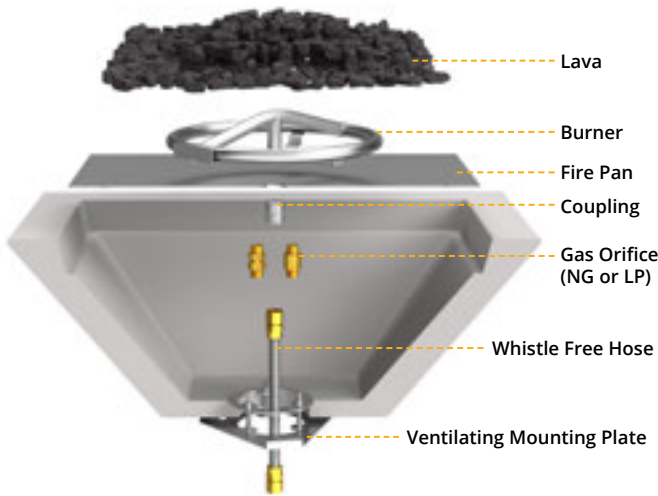

## MATCH LIT FIRE & WATER BOWLS

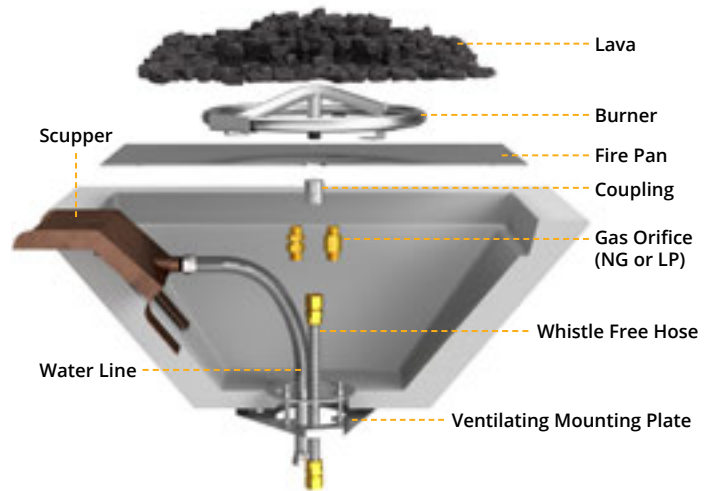

## 12V/110V FIRE BOWLS

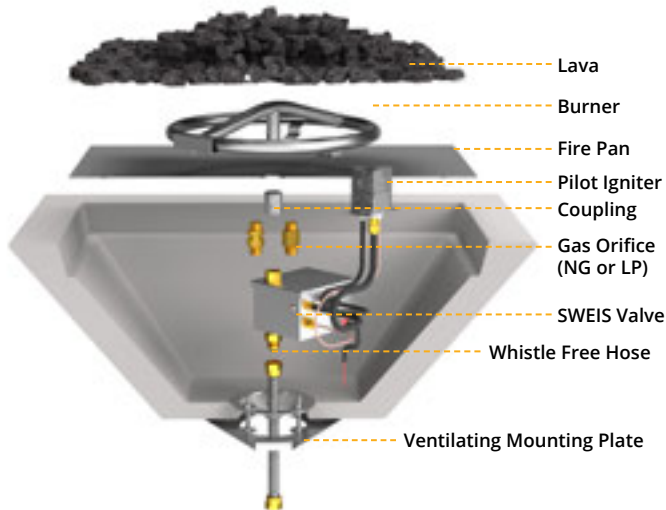

## 12V/110V FIRE & WATER BOWLS

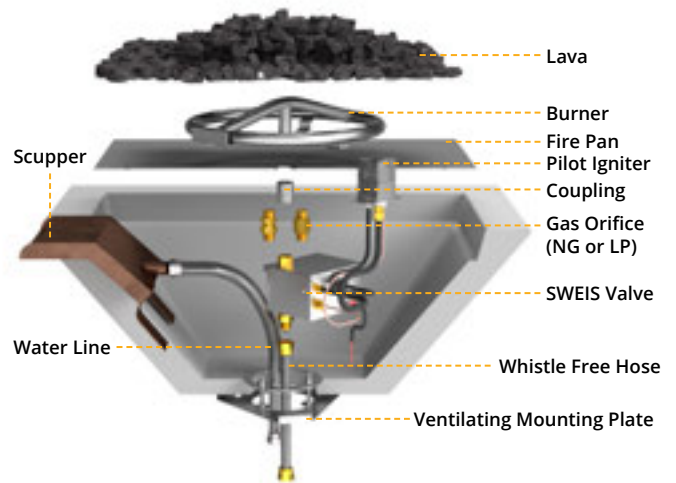

### Liquid Propane

Liquid Propane applications require a Brass Air Mixer Orifice. This orifice integrates air into the propane for a cleaner burning flame. This prevents soot from being created and staining the unit and other surroundings.

### Natural Gas

Natural Gas applications come with a brass orifice mounted directly underneath the burner. Key Valves must be mounted within arms reach of the burner.

**NOTE:** Key Valves may be installed onto the face of the bowl. To have your bowls shipped like this for an addi-

tional fee, add OPT-KVI to your order (Includes Key Valve, Whistle Free Hose & Installation)



### Mounting Brackets

All fire bowls come shipped with a mounting bracket. This mounting bracket provides ventilation and a secure mount.

**WARRANTY IS VOID IF THE MOUNTING BRACKET IS NOT INSTALLED.**

### Propane & Glass

It is not recommended to use any sort of fire glass or glass pebbles in Liquid Propane applications. Propane is 1.5x heavier than air and sinks, decorative glass is dense and may not allow the propane to properly rise. Propane may collect and pool under the surface of the glass or inside the enclosure creating a potentially dangerous situation.