

# REGAL

OWNERS MANUAL  
MANUAL DE INSTRUCCIONES



ComfortBase®

GLIDEAWAY™

# Contents

Safety Information .....	2
What Is Included .....	5
Assembly - Base .....	6
Assembly - Headboard Bracket .....	9
Assembly - Bluetooth Module .....	11
Location of Controls - Remote .....	12
Operation - Main .....	13
Operation - Sleep Enhancement .....	15
Operation - Setting the Memory Presets .....	16
Operation - Linking the Remote .....	17
Troubleshooting .....	18
Available Accessories .....	20
Specifications .....	21
Technical Assistance .....	21
Service Requirements .....	21
Cleaning .....	21
Warranty .....	22
Registration .....	23

Spanish starts on page 25.

Español comienza en la página 25.

## User Info

Please take a moment and write down the serial number in the space provided below, in case you need to refer to it in the future. This information can be found by raising the head section of the bed.

SKU:           CB500REG

Serial Number \_\_\_\_\_

This number will be required for future service claims.

# SAFETY INFORMATION

## ATTENTION!

**IMPORTANT SAFETY INSTRUCTIONS. SAVE THIS MANUAL!  
PLEASE READ THESE INSTRUCTIONS THOROUGHLY BEFORE USING  
THIS PRODUCT. PROPER OPERATION OF YOUR ADJUSTABLE BED IS  
NECESSARY TO ENSURE THE LONG LIFE AND DURABILITY YOU  
EXPECT FROM A HIGH-QUALITY PRODUCT. THE MANUFACTURER  
HAS TESTED AND INSPECTED THIS PRODUCT PRIOR TO SHIPMENT.**

RADIO FREQUENCY IS 2.4 GHZ.

FCC compliance device complies with part 15 of the FCC Rules.

Operation is subject to the following two conditions:

- (1) This device may not cause harmful interference, and
- (2) this device must accept any interference received, including interference that may cause undesired operation.

Any change to the antenna or the device could result in the device exceeding the RF exposure requirements and void the user's right to operate the device.

The input voltage is AC100-240 50/60HZ; the output voltage is DC29V 1.8A.

## ELECTRICAL SAFETY

Always unplug this adjustable bed frame from the electrical outlet before any cleaning or maintenance of the bed frame. To safely disconnect, remove the plug from the outlet. Keep cord away from heated surfaces. Use only indoors.

**WARNING: TO PREVENT FIRE OR SHOCK HAZARD, DO NOT EXPOSE THIS UNIT TO MOISTURE.**

Discontinue use of this adjustable bed base and contact the manufacturer for repair if:

- (1) it has a damaged cord or plug, (2) it is not working properly, (3) it has been dropped or damaged.

FOR OPTIMAL SAFETY, YOUR ADJUSTABLE BED SHOULD BE PLUGGED INTO A SURGE PROTECTOR (not supplied with this adjustable bed).

## BATTERY PRECAUTIONS

Follow these precautions when using batteries in this device:

1. Warning – Danger of explosion if battery is incorrectly replaced. Replace only with the 6LR61 9V batteries and LRO3 AAA batteries.
2. Be sure to follow the correct polarity when installing the batteries as indicated in the battery compartment. A reversed battery may cause damage to the device.
3. Do not mix different types of batteries together (e.g. Alkaline, Rechargeable and Carbon-zinc) or old batteries with fresh ones.
4. If the device is not to be used for a long period of time, remove the batteries to prevent damage or injury from possible battery leakage.
5. Do not try to recharge a battery not intended to be recharged; it can overheat and rupture. (Follow battery manufacturer's directions.)

# SAFETY INFORMATION

## WARRANTY WARNING!

This bed is specifically designed to require no maintenance by you, the user. Any opening or tampering with the control box, motors or hand controls (with the exception of the battery compartment, if equipped) will void the warranty. Do not attempt to alter component wiring or adjust or modify the structure of the product in any way or the warranty will be void. Only those authorized may conduct repairs or part replacement on your adjustable bed.

## IN-HOME USE ONLY

This adjustable bed is designed exclusively for in-home use.

**HOSPITAL/MEDICAL DISCLAIMER:** This base is NOT designed for hospital or medical use (In-Home or Commercial) and is NOT designed to meet medical or hospital standards. Do not use this base with TENT TYPE oxygen therapy equipment or use near explosive gases.

## CONSUMERS WITH PACEMAKERS

It is possible that the vibrating feature of this bed may be interpreted falsely by some pacemakers as movement and/or exercise. This is common with any product that produces a vibrating motion, and may or may not affect your pacemaker. Please consult your physician with any concerns.

## PRODUCT RATINGS

**Lift Motor Restrictions:** The lift motors in this bed are NOT designed to operate continuously for more than one (1) minute over an eight (8) minute time period, or approximately 12% duty cycle. To ensure reliable functionality and full life of this product, do not attempt to exceed these limits.

**NOTE:** Attempting to circumvent or exceed this rating will shorten the life expectancy of the product and may void the warranty.

**Weight Restrictions:** The recommended weight limits on our adjustable beds are:  
Queen: 600 lb    Full/XL: 500 lb    Twin/XL: 400 lb (800 lb if using two twins as a King)

The structure of the bed will support the recommended weight when distributed evenly across the bed.

**The head and foot sections are not designed to individually support or lift this amount of weight.**

For optimal performance and integrity of structure, entering and exiting the adjustable bed with the bed in the flat position is recommended.

**NOTE:** Exceeding the recommended weight restrictions could damage your adjustable bed and void your warranty.

## Vibe Motor Restrictions:

Vibe motors are not designed for continuous, extended vibe motor operation. Vibe motor systems are rated for a maximum of two hours of use within any six hour period.

The vibe motor feature will emit a minimal tone during operation. This is normal. When the vibe motor level is increased, motor resonance will intensify accordingly.

# SAFETY INFORMATION

## SMALL CHILDREN AND PETS WARNING

Immediately dispose of all packing materials as they can pose a smothering risk to small children and pets. Injury could occur also if children or pets are permitted to play on or under the bed. Do not allow children to operate this bed without adult supervision.

## LUBRICATION AND CLEANING

This product is designed to be maintenance free. The lift motors are permanently lubricated and sealed—no additional lubrication is required. Do not apply lubricant to lift motor lead screws or any nylon nuts or the base may inadvertently creep downward from the elevated position.

## LIFT WARNING

**DO NOT SIT ON THE HEAD OR FOOT SECTIONS WHILE IN THE RAISED POSITION, OR DURING LIFT OR LOWERING CYCLES.**

## LOCATION ENVIRONMENT

The level of sound experienced during operation is directly related to the location environment. For example, when a base is located on a hardwood floor with the vibrate feature in operation, a vibrating tone will be audible. To minimize this resonance, place a piece of carpet under each leg of the base.

It is possible to experience vibration or noise from the headboard brackets, headboards or foot boards if mounting bolts are not firmly tightened.

## MOVING AFTER INSTALLATION

Do not place adjustable bed base vertically on its head or foot sections. This may cause injury to persons or damage to base.







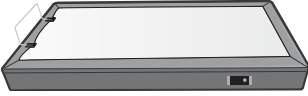

## WARNING!

To reduce the risk of burns, fire, electric shock, or injury to persons:

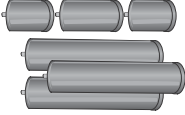
- Unplug from outlet before putting on or taking off accessories.
- Close supervision is necessary when this base is used by, or near children, invalids, disabled persons, or pets.
- Use this base only for its intended use as described in these instructions. Do not use attachments not recommended by the manufacturer.
- Never operate this base if it has a damaged cord or plug, is not working properly, has been dropped or damaged, or dropped in water.
- Keep the cord away from heated surfaces.
- Never drop or insert any object into any opening.
- Do not use outdoors.
- Do not operate where aerosol (spray) products are being used or where oxygen is being administered.
- To disconnect, remove plug from outlet.
- **DO NOT USE NEAR PEOPLE USING OR WEARING MEDICAL DEVICES. FOR HOUSEHOLD/RESIDENTIAL USE ONLY.**

# WHAT IS INCLUDED

Before discarding any packing materials, check the adjustable base shipping carton and verify the following items are included:

	(1) Base
	(1) Foot Mattress Retainer (attached to the base)
	(4) Multi-Height Low Profile Legs (Overall Bed height 8", 11.5" or 15" )
	(1) AC Cord (not attached to the base)
	(1) Power Supply (not attached to the base)
	(1) DC Power Cord
	(1) Headboard Bracket Kit
	(1) Sync Cable (Twin XLs only)
	Also included: (3) AAA Batteries and (2) 9V Batteries

# ASSEMBLY - BASE

It is HIGHLY recommended to use two people for the installation of this product. To assemble, please perform the following steps:

- 1 Carefully lift the base frame from the shipping carton, keeping the unit top-side-down. Remove the plastic wrapping from the bottom to access the base.

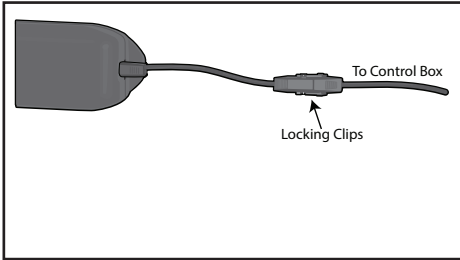

- 2 Insert one end of the DC cord into the power supply. Insert the other ends with locking clips into the Control Box and USB Charger cords. Lock the Control Box and USB Charger cords using the locking clips.

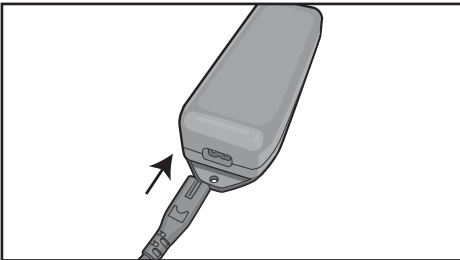

- 3 Insert the AC cord into the power supply.  
**IMPORTANT: DO NOT PLUG THE BASE INTO THE AC OUTLET YET.**

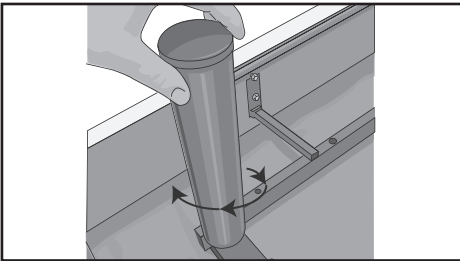

- 4 Insert the legs into the threaded holes at each corner of the base by inserting the leg and rotating clockwise until tight. There must not be any gap or wobble in the leg in order to avoid risk of injury or damage to the base which may void warranty.

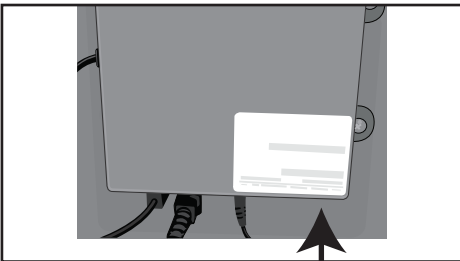

**Note:** If setting two Twin XL's bases to use with one king size mattress, connect the Sync cable to the control box (as pictured) to one base. After bases are arranged, connect the second Sync Cable to other base's control box.

# ASSEMBLY - BASE

- 5 Remove the Mattress Retainer Bar from the bottom of the base. Finish removing the plastic packaging from the base to orient into final position. Carefully rotate the base on its side, then lift and place on legs.

**IMPORTANT: DO NOT LEAN THE BED AGAINST THE INSTALLED LEGS TO TURN OVER.**

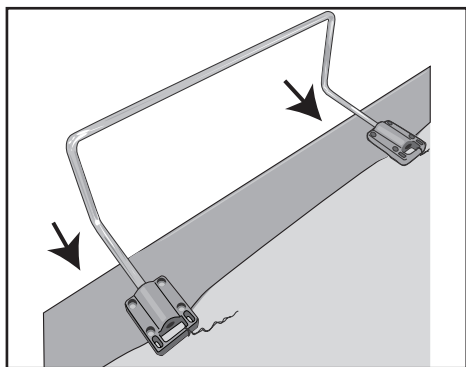

- 6 Insert the Mattress Retainer Bar upright as shown.

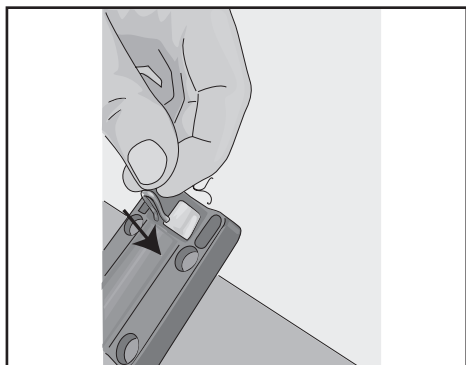

- 7 Replace the retainer clip securely.



# ASSEMBLY - BASE

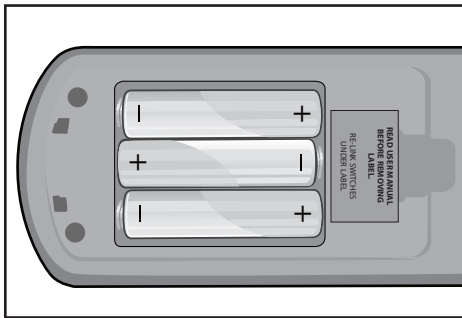

## REMOTE

Lift the battery cover and insert the three AAA size batteries (included) into the remote as shown in the figure. Replace the battery cover.

Remote is already linked with the base.

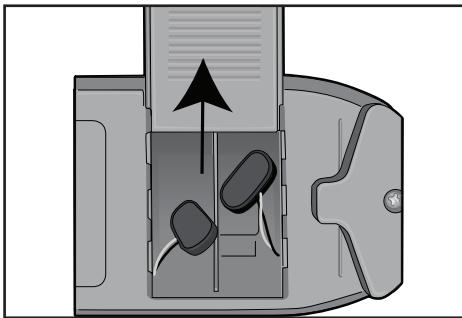

## BASE POWER SUPPLY

Turn the power supply upside down to access the battery cover, then slide the battery cover off.

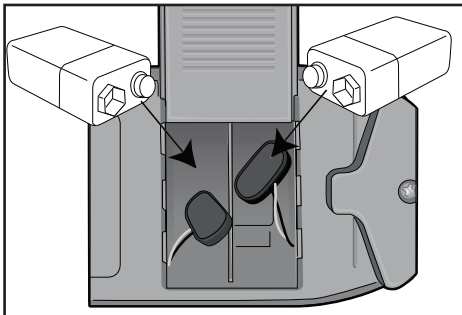

Insert the two 9V battery (included) into the compartment and slide the cover back on.

**NOTE:** The battery backup will allow for the bed to be lowered if a power outage occurs. It is not recommended to do anything except lower the bed as the battery backup will not last if the features are continually used.

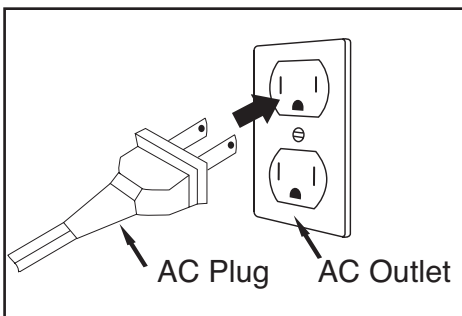

Insert AC plug into an AC outlet having 100-240V AC, 50/60Hz.

**Note:** If attaching a headboard to the base, see the included instructions. Otherwise, place the desired mattress onto the base and enjoy your new adjustable base!

# Assembly - Headboard Bracket

Headboard brackets may not be standard with purchase of adjustable base and can be purchased separately. See page 16 to purchase.

**IMPORTANT:** The headboard bracket must be assembled to the base **AFTER** the bed base has been completely assembled. After assembling the bed according to the owner's manual, see this sheet to assemble the headboard bracket.

Unpack the kit and make sure the following is included:



Bed Attachment  
PART A  
Qty: 2



Horizontal Shaft  
PART B  
Qty: 2

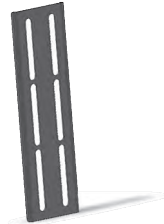

Headboard Attachment Plate  
PART C  
Qty: 2



M8x16mm Hex Bolt  
PART D  
Qty: 8



M8 Bolt  
PART E  
Qty: 4



M8 Nut  
PART F  
Qty: 4



Washer 10 Zinc  
PART G  
Qty: 4

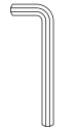

Allen Key  
PART H  
Qty: 1

- 1 Completely raise the headsection of the bed to access the frame to which the headboard bracket will mount. Identify the two threaded holes that will be used to mount bed attachment (Part A) in Step #2

Fig. 1



- 2 Line up the holes in the bed attachment (Part A) with the two threaded holes on the bed base. Make sure the horizontal fitting of the bed attachment (Part A) points towards the inside of the bed. Insert two screws (Part D) provided with the kit into the threaded holes and tighten with the Allen key (Part H) provided with the kit.

Fig. 2

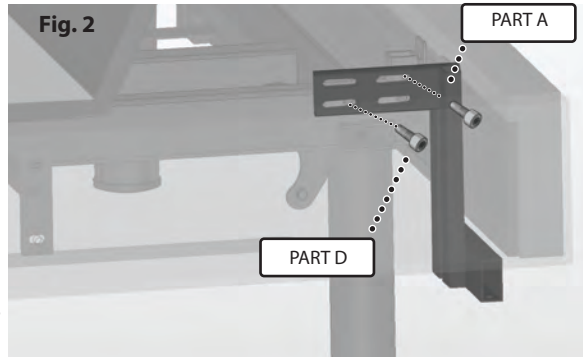

# Assembly - Headboard Bracket

**3** Attach the headboard attachment plate (Part C) to the horizontal shaft (Part B) using the two flat head self locking screws (Part E), two washers (Part G) and two nuts (Part F) provided with the kit.

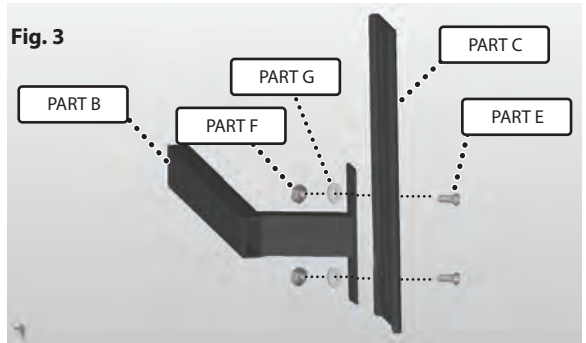

**4** Insert, from the outside of the bed, the horizontal shaft (Part B) into the horizontal fitting of the bed attachment (Part A).

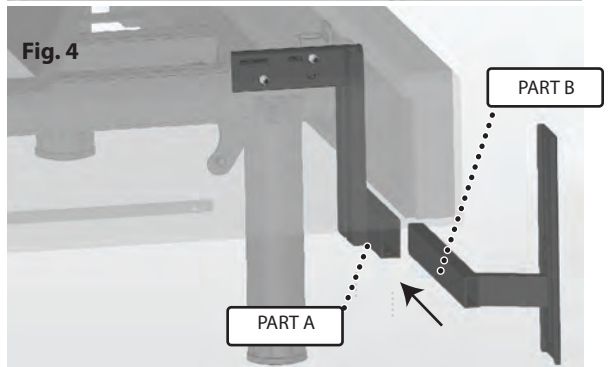

**5** Adjust the position of the headboard attachment plates (Part C) to the right or the left of the bed as desired by moving the horizontal shaft (Part B) left and right in the horizontal fitting of the bed attachment (Part A). Once positioned correctly tighten screws (Part D) to hold in place.

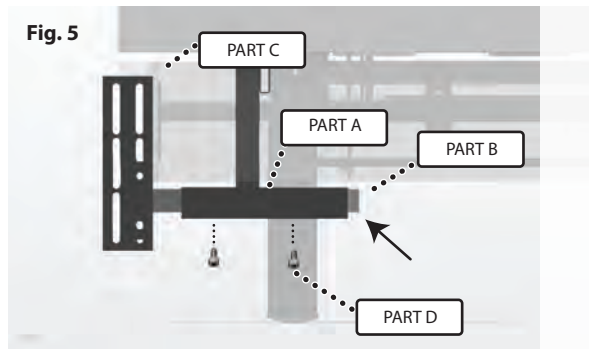

To adjust the position of the headboard attachment plates (Part C) vertically, loosen nuts and screws from step 3. Tighten when the appropriate height for your headboard is met.

Install the headboard using the line of 3 oval holes on the outside of the headboard attachment plate.

**WARNING:** The end of the horizontal shaft (Part B) must always extend beyond the end of the horizontal fitting of the bed attachment! (Part A) (See Fig. 5 Arrow)

# ASSEMBLY - BLUETOOTH MODULE

1 In order to start using your new Bluetooth compatible Comfort Base, first download our app in the Apple or Google Play store.

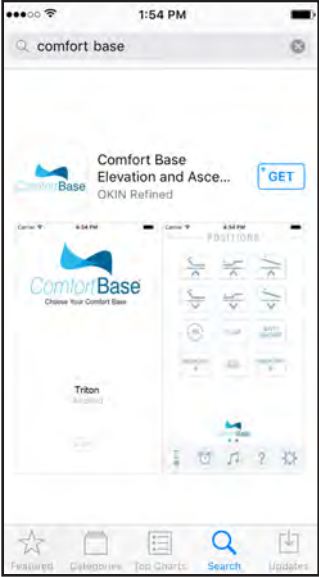

2 Once downloaded, open the app & follow the instructions. In a matter of minutes you will be able to enjoy the ability to control your Comfort Base from any Apple or Android device!

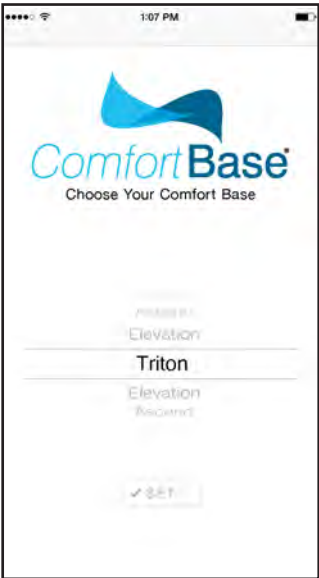

# LOCATION OF CONTROLS - REMOTE

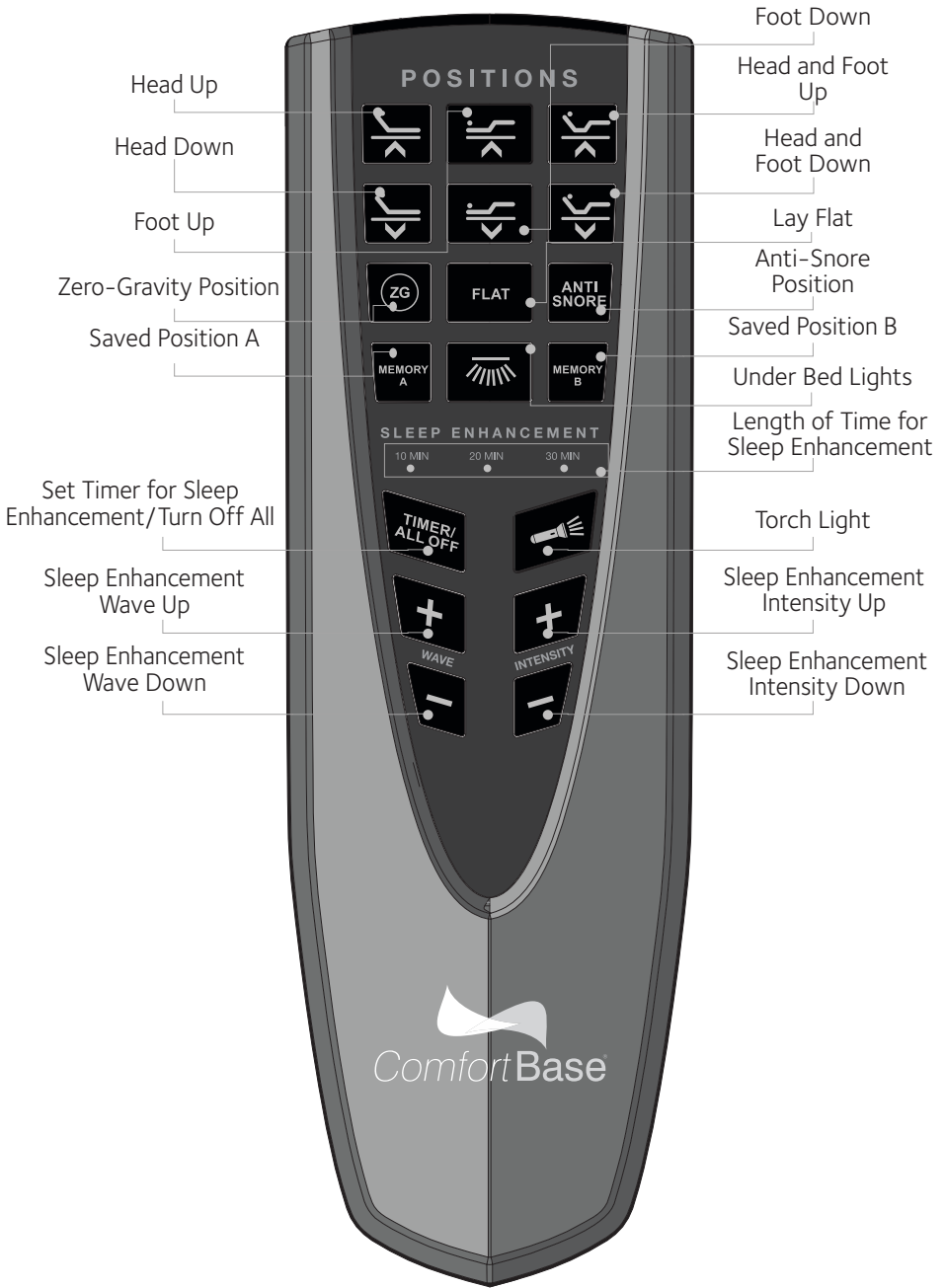

# OPERATION - MAIN

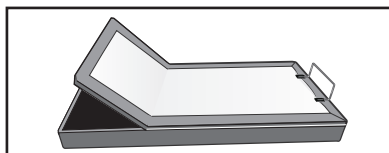

Press and hold the Head Up (  ) button to raise the Head position. Release button when desired position is reached.

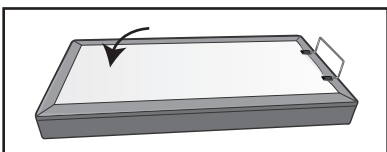

Press and hold the Head Down (  ) button to lower the Head position. Release button when desired position is reached.

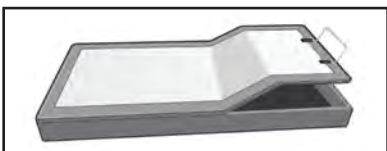

Press and hold the Foot Up (  ) button to raise the foot position. Release button when desired position is reached.

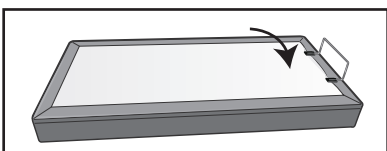

Press and hold the Foot Down (  ) button to lower the foot position. Release button when desired position is reached.

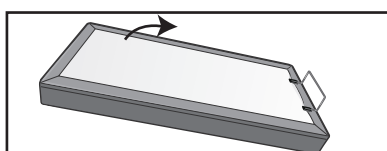

Press and hold the Elevation Up (  ) button to raise base. Release button when desired position is reached.

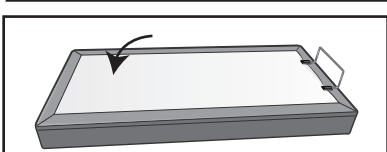

Press and hold the Elevation Down (  ) button to lower base. Release button when desired position is reached.



The Zero-Gravity position raises both the head and foot to a set position that distributes the users weight so that it may provide a feeling of weightlessness and possibly relieve stress to the body. Press the Zero Gravity (  ) button and the Head/Foot positions will go to the Zero Gravity position. This action can be stopped at any time by pressing another button.





The Anti-Snore position raises the head slightly so that it may allow relief to snoring. Press the ANTI-SNORE (  ) button and the Head position will go to the Anti-Snore position. This action can be stopped at any time by pressing another button.

# OPERATION - MAIN



Press the FLAT (  ) button and the bed will level. This action can be stopped at any time by pressing another button.



Press the MEMORY A (  ) or MEMORY B (  ) button and the Head/Feet positions will go to the preset position. This preset can be changed as shown later. This action can be stopped at any time by pressing another button.

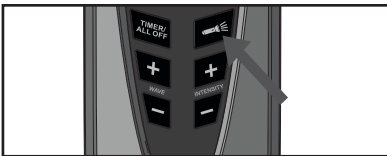

Press and hold the Flashlight (  ) button and the remote will act as a mini flashlight. Release the button and after a few seconds, the flashlight will turn off.



Use this feature to get out of bed without disturbing your partner. Press the Light (  ) button and the LED lighting under the bed will light. Press again to turn the under-the-bed lighting off. The LED under-bed lighting will turn off on it's own after five minutes.

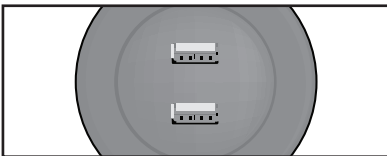

**USB:** This bed can charge standard devices that utilize a USB cable. A pair of USB jacks are located on each side of the bed base. Simply plug a USB cable into one of the USB jacks, and the other end into the device you want to charge.

## Notes:

- When a unit connected to the USB jack is fully charged, remove the plug from the USB jack.
- When a button is pressed on remote, all buttons will light to make it easier to view in low light conditions.
- **EMERGENCY LOWERING:** If you cannot find the remote control, locate and press the red Emergency Lowering button located on the main control box on the bottom of the bed (shown to the left).

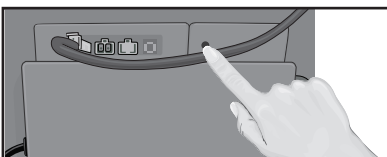

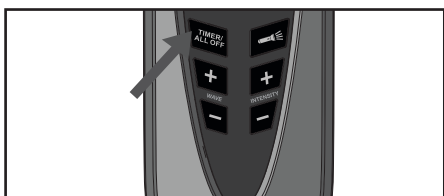

# OPERATION - SLEEP ENHANCEMENT

Sleep Enhancement may help to ease the body to sleep and creates a white noise effect through total body vibration.



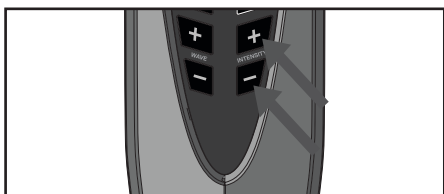

- 1 Before starting a the total body vibration, select the duration. To do this, repeatedly press the TIMER/ALL OFF (  ) button to select a duration; the respective Sleep Enhancement LED (10MIN, 20MIN or 30MIN) will briefly light.

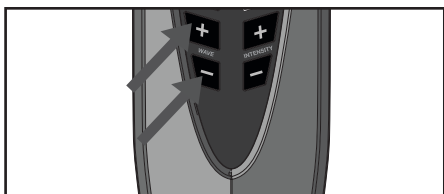

- 2 To start the total body vibration, press the INTENSITY or WAVE + (  ) button once. Press up to three more times to increase the massage intensity (up to four levels of intensity). Press the INTENSITY - (  ) button to decrease the intensity.



- 3 There are 4 Wave modes available (Low, Medium, High, and Constant). To increase the Wave mode, press the + WAVE (  ) button once. Press up to three more times to change the WAVE mode. It will increase in order of Low, Medium, High, and Constant. Press the - WAVE (  ) button to lower the wave mode. Experiment with different Wave and Intensity settings to find what is most comfortable to you. The higher the intensity, the more beneficial it will be to your body.

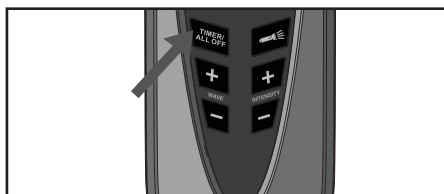

- 4 The total body vibration will last for the duration of time set in step 1. To turn off the massage before the time is up, simply press the TIMER/ALL OFF (  ) button.



# OPERATION - SETTING THE MEMORY PRESETS

To set the Memory A and/or Memory B presets, perform the following steps:

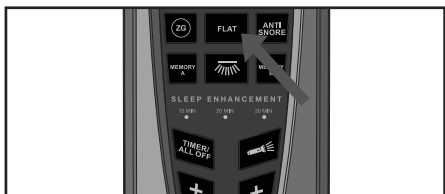

1 Press the Flat (  ) button so the bed is flat.

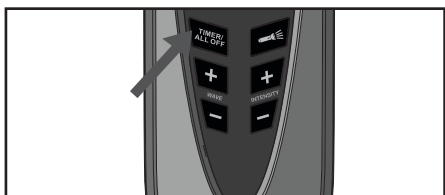

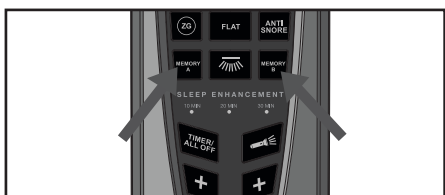

2 Adjust the head and foot positions as desired.

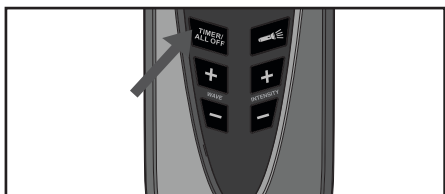

3 Press and hold the TIMER/ALL OFF (  ) button until the remote's backlight starts blinking (approximately three seconds), then release the button.



4 Press the desired button to memorize: MEMORY A (  ) or MEMORY B (  ); the backlight will stop blinking to confirm that the memorizing was successful.

5 To restore the Memory Presets to their factory positions, press and hold the TIMER/ALL OFF (  ) button for approximately six seconds; the remote's backlight will blink after three seconds, and then turn off after another three seconds to confirm that the remote was reset.

# OPERATION - LINKING THE REMOTE

## How do I link my remote control to the Comfort Base?



Connecting one Remote to one base

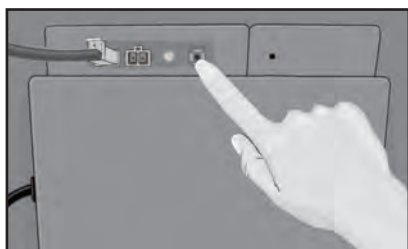

- 1 Press and hold the Link button (the black round button on the control box located on the bottom of the base) until the LED light on the control box turns on and then off. Release the button and the LED light will blink.

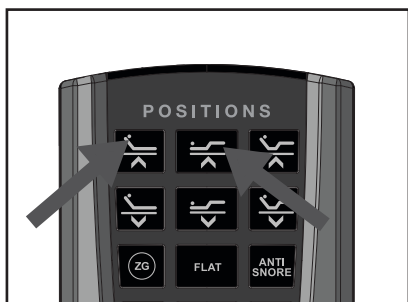

- 2 Simultaneously press and hold the Head Up and Foot Up buttons until the remote's backlight starts blinking. Release the two buttons and the backlight and the LED light on the control box will blink until linked, then they will turn off.
- 3 Test the bed to make sure it is working, and repeat the steps if it is not.

## How do I Re-Program the Zero-Gravity button back to factory setting?

The Zero-Gravity button has the capability to be re-programmed. In case you would like to set it back to the original Zero-Gravity setting follow the below instructions:

1. Raise Head to 17 degrees.
2. Raise Foot to 25 degrees.
3. Press and hold the program button labeled "TIMER/ALL OFF button" until the remote starts to flash.
4. Release program button.
5. Press Zero Gravity button once.
6. Done.

# TROUBLESHOOTING

In the event the Comfort Base's base fails to operate, investigate the symptoms and possible solutions provided below:

<b>Remote control illuminates and appears to be operable, but no features of the base will activate.</b>	<ul style="list-style-type: none"><li>• Unplug power cord, wait 30 seconds and plug in to reset electronic components.</li><li>• Defective surge protection device or electrical outlet. Test outlet by plugging in another working appliance.</li><li>• Electrical circuit breaker may be tripped. Check electrical service breaker box to verify.</li><li>• Re-link the remote control (see Remote Control Re-Linking section of this manual for programming procedures).</li></ul>
<b>Remote control will not illuminate.</b>	<ul style="list-style-type: none"><li>• Replace batteries in the remote control.</li></ul>
<b>Head or foot section will elevate, but will not return to the horizontal (flat) position.</b>	<ul style="list-style-type: none"><li>• Base mechanism may be obstructed. Elevate base and check for obstruction. Remove obstruction.</li><li>• Headboard may be too close to the edge of the mattress. Verify that distance between headboard brackets and mattress is sufficient. Adjust if required.</li></ul>
<b>Excessive massage motor noise.</b>	<ul style="list-style-type: none"><li>• If base is located on hard surface flooring, place carpet pieces or rubber cups under each leg of the base.</li><li>• Verify that the base is not positioned against a wall, nightstand, or other object that may cause vibration or noise.</li><li>• If base is installed inside a wood bed frame, verify vibrate motor is not causing bed frame (or bed frame components) to vibrate.</li><li>• Verify that headboard attachment hardware is tightened firmly (if used).</li></ul>
<b>Head or Foot Lift Function has minor interference during operation.</b>	<ul style="list-style-type: none"><li>• Check batteries in remote, replace if necessary.</li><li>• Make sure that you are following the duty cycle of the motor (do not operate more than one (1) minute over an eight (8) minute period, or approximately a 12% duty cycle).</li><li>• Press the lift buttons squarely and accurately.</li><li>• Control box may be experiencing common Radio Frequency Interference from other radio transmitting devices (see Remote Control Re-Linking section).</li></ul>

**Continued on the Next Page**

# TROUBLESHOOTING

<b>If USB ports do not charge:</b>	Check the blue LED on the USB charging port, If it is on: <ul style="list-style-type: none"><li>• Try another USB cable that is known good.</li><li>• If USB port still does not charge, unplug all USB cables from base and allow USB charging port to reset. Wait 10 minutes and try again.</li><li>• If it still does not charge, call for service.</li></ul>
<b>If blue LED is off:</b>	<ul style="list-style-type: none"><li>• Check if base functions properly, if yes, then call for service.</li><li>• If base does not work, check AC wall outlet power by plugging a known working appliance into it.</li><li>• If outlet has power, call for service.</li></ul>
<b>The remote is causing interference with appliances, TV, garage door opener, another base in a different room, etc.</b>	<ul style="list-style-type: none"><li>• Lift the battery cover on remote and remove the yellow sticker to expose the DIP switches. Slide the switches to different positions.</li><li>• See page 16 for remote re-linking instructions.</li><li>• After re-linking, test the bed to make sure it is working, and repeat steps if it is not.</li></ul>

# AVAILABLE ACCESSORIES

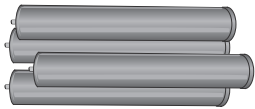
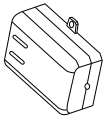
	<b>Item</b>	<b>Part Number</b>
	High Profile Legs (Overall Bed Height 18.5")	CB3LEG18.5
	Bluetooth Module	CB-BLUETOOTH

**To order an accessory, please call 1-800-428-5222**

# SPECIFICATIONS

Weight Capacity ..... Queen: 600 lb, Full/XL: 500 lb,  
..... Twin/XL: 400 lb (800 lb if using two twins as a King)  
Power Input ..... AC100-240 50/60HZ  
Power Transformer Output.....DC29V 1.8A  
Radio Frequency ..... 2.4 GHZ  
USB Power Output..... 2.1A (Max)  
Overall Height of Bed.....15 inches  
Incline.....Head - 65°, Feet - 35°  
Included Accessories ..... Sync Cable (Twin XL size only), Mattress Retainer Bar,  
..... Headboard Bracket Kit, Remote Control, Power Supply,  
..... AC and DC Power Cords, (2) 9V Battery for Battery Backup,  
..... (3) AAA Batteries for Remote, (1) Manual, (1) Remote Control Pocket

## TECHNICAL ASSISTANCE

For any questions, claims, or technical assistance, please contact Glideaway at 1-855-581-3095 or [comfortbase@glideaway.com](mailto:comfortbase@glideaway.com)

## SERVICE REQUIREMENTS

Service technicians are not responsible for moving furniture, removing headboards and foot boards, or any items required to perform maintenance on your adjustable bed. In the event the technician is unable to perform service due to lack of accessibility, the service call could be billed to the purchaser and the service will be re-scheduled.

## CLEANING

Spot clean with upholstery shampoo, foam from a mild detergent, or mild dry cleaning solvent. Pre-test a small inconspicuous area before proceeding. Do not saturate. Pile fabrics may require brushing with a non-metallic bristle brush. Hot water extraction or steam cleaning is not a recommended cleaning method.