



FREESTYLE 2.0

OWNERS MANUAL



Contents

Safety Information	3
What Is Included	6
Assembly - Base	7
Assembly - Connecting Bases	13
Location of Controls - Remote	14
Operation - Main	14
Operation - Linking the Remote	16
Troubleshooting	17
Online Resources	18

User Info

Please take a moment and write down the serial number in the space provided below, in case you need to refer to it in the future. This information can be found by raising the foot section of the bed.

SKU: CBO0WH

Serial Number _____

This number will be required for future service claims.

Safety Information

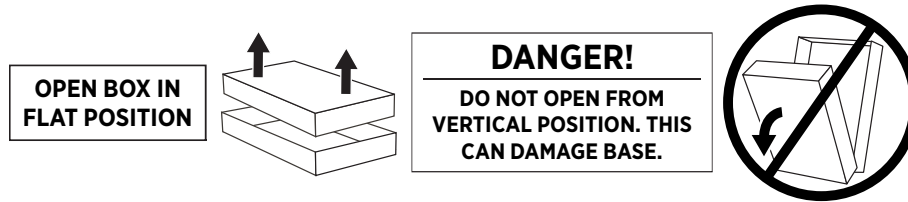

ATTENTION!

IMPORTANT SAFETY INSTRUCTIONS. SAVE THIS MANUAL!

PLEASE READ THESE INSTRUCTIONS THOROUGHLY BEFORE USING THIS PRODUCT. PROPER OPERATION OF YOUR ADJUSTABLE BED IS NECESSARY TO ENSURE THE LONG LIFE AND DURABILITY YOU EXPECT FROM A HIGH-QUALITY PRODUCT. THE MANUFACTURER HAS TESTED AND INSPECTED THIS PRODUCT PRIOR TO SHIPMENT.

RADIO FREQUENCY IS 2.4Ghz.

This device complies with part 15 of the FCC Rules and Industry Canada's license exempt RSSs. Operation is subject to the following two conditions:

- (1) This device may not cause interference, and
- (2) This device must accept any interference received, including interference that may cause undesired operation of the device.

Any change to the antenna or the device could result in the device exceeding the RF exposure requirements and void the user's right to operate the device. The input voltage is AC100-240 50/60HZ; the output voltage is DC29V 1.8A. Total USB power output is 2 AMP.

ELECTRICAL SAFETY

Always unplug this adjustable bed from the electrical outlet before any cleaning or maintenance of the adjustable bed. To safely disconnect, remove the

WARNING: TO PREVENT FIRE OR SHOCK HAZARD, DO NOT EXPOSE THIS UNIT TO MOISTURE.

plug from the outlet. Keep cord away from heated surfaces. Use only indoors.

Discontinue use of this adjustable bed and contact the manufacturer for repair if:

- (1) It has a damaged cord or plug,
- (2) It is not working properly, or
- (3) It has been dropped or damaged.

FOR OPTIMAL SAFETY, YOUR ADJUSTABLE BED SHOULD BE PLUGGED INTO A SURGE PROTECTOR (not supplied with this adjustable bed).

BATTERY PRECAUTIONS

Follow these precautions when using batteries in this device:

- (1) Warning – Danger of explosion if battery is incorrectly replaced. Replace only with the 6LR61 9V batteries and LR03 AAA batteries.
- (2) Be sure to follow the correct polarity when installing the batteries as indicated in the battery compartment. A reversed battery may cause damage to the device.
- (3) Do not mix different types of batteries together (e.g. Alkaline, Rechargeable and Carbon-zinc) or old batteries with fresh ones.
- (4) If the device is not to be used for a long period of time, remove the batteries to prevent damage or injury from possible battery leakage.
- (5) Do not try to recharge a battery not intended to be recharged; it can overheat and rupture. (Follow battery manufacturer's directions.)

Safety Information

WARRANTY WARNING!

This bed is specifically designed to require no maintenance by you, the user. Any opening or tampering with the control box, motors or hand controls (with the exception of the battery compartment, if equipped) will void the warranty. Do not attempt to alter component wiring or adjust or modify the structure of the product in any way or the warranty will be void. Only those authorized may conduct repairs or part replacement on your adjustable bed.

IN-HOME USE ONLY

This adjustable bed is designed exclusively for in-home use.

HOSPITAL/MEDICAL DISCLAIMER: This base is NOT designed for commercial hospital or medical use and is NOT designed to meet hospital standards. Do not use this base with TENT TYPE oxygen therapy equipment or use near explosive gases.

PRODUCT RATINGS

Lift Motor Restrictions: The lift motors in this bed are NOT designed to operate continuously for more than one (1) minute over an eight (8) minute time period, or approximately 12% duty cycle. To ensure reliable functionality and full life of this product, do not attempt to exceed these limits.

NOTE: Attempting to circumvent or exceed this rating will shorten the life expectancy of the product and may void the warranty.

Weight Restrictions: The recommended weight limits on our adjustable beds are:

- 1/pc King: 800 lb
- Queen: 650 lb
- Full/XL: 500 lb
- Twin/XL: 400 lb (800 lb if using two twins as a King)
- The structure of the bed will support the recommended weight when distributed evenly across the bed.
- **The head and foot sections are not designed to individually support or lift this amount of weight.**
- For optimal performance and integrity of structure, entering and exiting the adjustable bed with the bed in the flat position is recommended.
- **NOTE: Exceeding the recommended weight restrictions could damage your adjustable bed and void your warranty.**

Safety Information

SMALL CHILDREN AND PETS WARNING

Immediately dispose of all packing materials, as they can pose a smothering risk to small children and pets. Injury could also occur if children or pets are permitted to play on or under the bed. Do not allow children to operate this bed without adult supervision.

LUBRICATION AND CLEANING

This product is designed to be maintenance free. The lift motors are permanently lubricated and sealed—no additional lubrication is required. Do not apply lubricant to lift motor lead screws or any nylon nuts or the base may inadvertently creep downward from the elevated position.

LIFT WARNING

DO NOT SIT ON THE HEAD OR FOOT SECTIONS WHILE IN THE RAISED POSITION, OR DURING LIFT OR LOWERING CYCLES.

MOVING AFTER INSTALLATION

Do not place adjustable bed base vertically on its head or foot sections. This may cause injury to persons or damage to base.

WARNING!

To reduce the risk of burns, fire, electric shock, or injury to persons:

- Unplug from outlet before putting on or taking off accessories.
- Close supervision is necessary when this base is used by, or near children, invalids, disabled persons, or pets.
- Use this base only for its intended use as described in these instructions. Do not use attachments not recommended by the manufacturer.
- Never operate this base if it has a damaged cord or plug, is not working properly, has been dropped or damaged, or dropped in water.
- Keep the cord away from heated surfaces.
- Never drop or insert any object into any opening.
- Do not use outdoors.
- Do not operate where aerosol (spray) products are being used or where oxygen is being administered.
- To disconnect, remove plug from outlet.
- DO NOT USE NEAR PEOPLE USING OR WEARING MEDICAL DEVICES. FOR HOUSEHOLD/RESIDENTIAL USE ONLY.

What's Included

Before discarding any packing materials, check the adjustable base shipping carton and verify the following items are included:

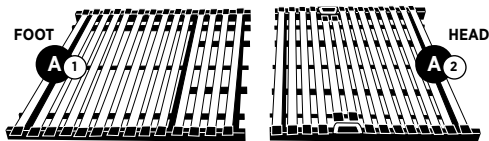

(2) Base Pieces

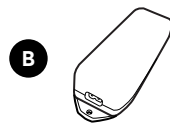

(1) Power Supply
(not attached to the base)

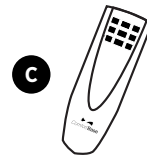

(1) Remote Control



(4) Brackets with Wing Nuts

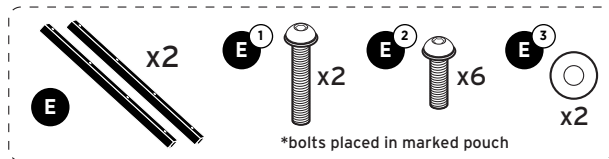

Inner Connecting Rods & Hardware

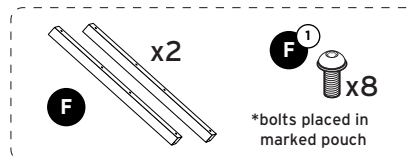

Outer Connecting Rods & Hardware



(1) AC Cord
(not attached to the base)

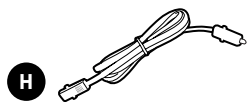

(1) DC Power Cord

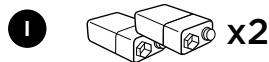

(2) 9V Batteries

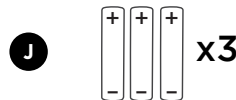

(3) AAA Batteries



(2) Hex Keys

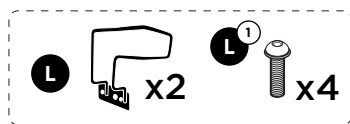

(2) Foot Mattress Retainers with (4) bolts



(1) Sync Cable
(for TXL/Split Cal King size only)

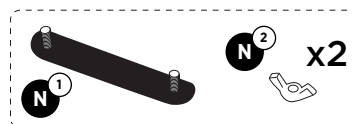

(1) Connector Plate with (2) Wing Nuts
(Twin XL/Split Cal King Only)

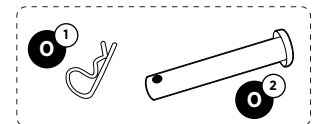

(1) Bolt and Retainer Pin
(Twin XL/Split Cal King Only)

IMPORTANT:

USE 2 PEOPLE TO LIFT BASE TO AVOID DAMAGE.

NOTE:

Carefully lift both Base Pieces from the shipping carton.
Remove the plastic wrapping from the bases.

Assembly - Base

It is HIGHLY recommended to use two people for the installation of this product.

To assemble, please perform the following steps:

- 1 Carefully lift both Base Pieces and remove the plastic wrapping from the bottom to access the bases. Remove the cable ties holding both Base Pieces together. Lay the two Base Pieces down and unpack the remaining items.

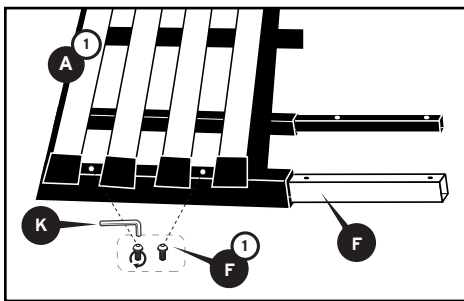

- 2 Insert the OUTER Connecting Rods (2) into the FOOT Base Piece and install two bolts into each of the Connecting Rods using the provided allen key.

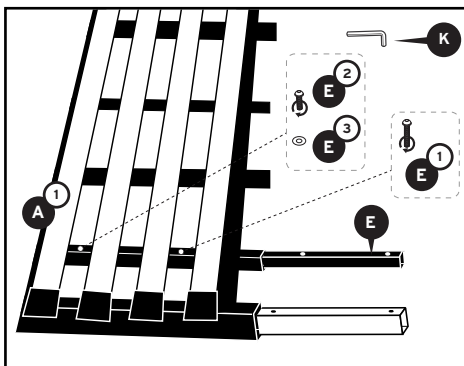

- 3 Insert the INNER Connecting Rods (2) into the FOOT Base Piece and install two bolts into each of the Connecting Rods using the provided allen key. Pay special attention to bolt length and washer placement.

NOTE:
INNER Connecting Rods must be oriented HEAD to FOOT as labeled.

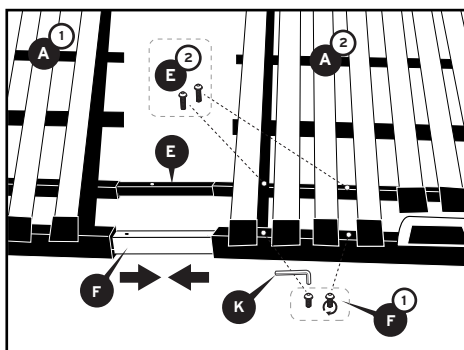

- 4 Slide the other HEAD Base Piece over exposed INNER Connecting Rods and OUTER Connecting Rods. Install the remaining bolts. Be sure to hand tighten each and then tighten 1/4 turn more, as over-tightening could cause damage to the frame or Connecting Rod.

Assembly – Base (cont'd)

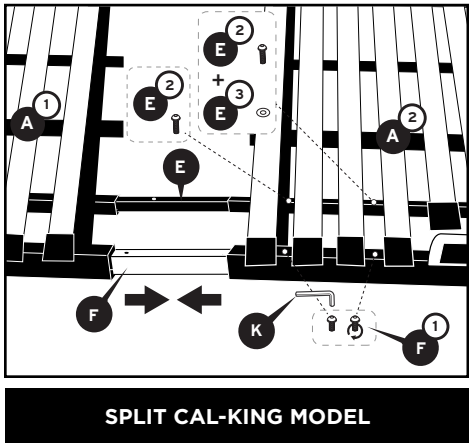

4 (continued)

NOTE:

For SPLIT CAL-KING MODELS ONLY, notice the difference in hardware used to secure the Connecting Rods.

5 Cut YELLOW cable ties securing foot motor cables to frame. Route foot motor cables under metal cross bars as indicated by labels on frame. **Improper placement of cable can cause permanent damage to your adjustable base.** Secure cables in plastic wire harness clip located near control box.

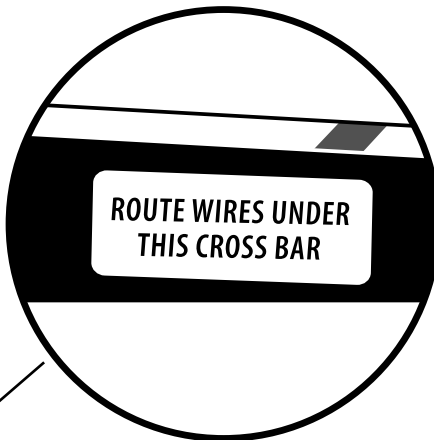

Assembly - Base (cont'd)

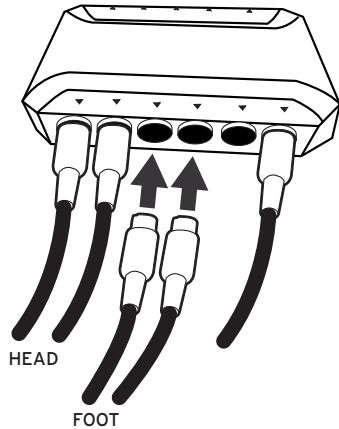

- 6** Connect the Foot motor connector to the Foot motor port on the control box as shown.

NOTE:

Lift HEAD of bed to access control box and plug in FOOT motor cables (marked by red bands).

Connect DC power cord (H) to control box as shown. Route cord thru plastic wire harness clips as shown.

You may now place base on foundation or platform bed

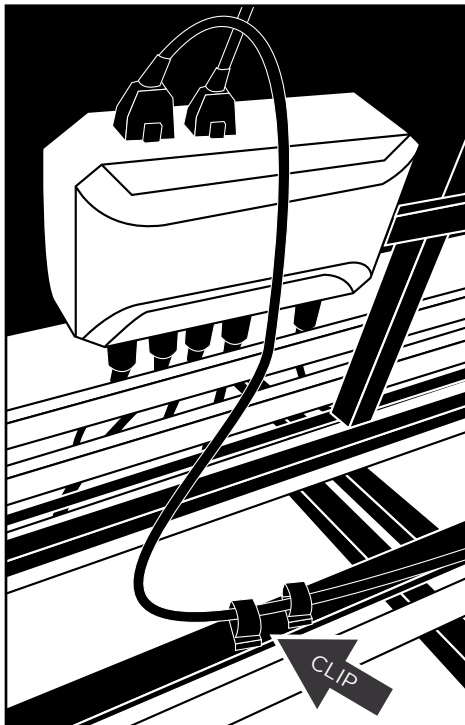

- 7** Route the DC power cord **H** to control box as shown. Route cord thru plastic wire harness clips as shown. You may now place base on foundation or platform bed.

NOTE:

If CONNECTING TWO BASES TO FORM A KING, repeat steps 1 through 7 for the second twin XL base, then continue to the next step.

Please see the **Assembly - Connecting Bases** section for further detailed instructions (p13).

Assembly - Base (cont'd)

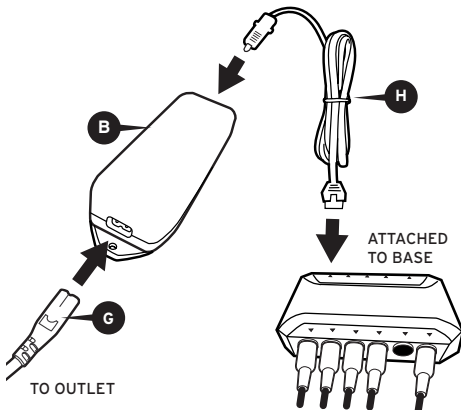

- 8 Insert the AC Cord **G** into the power supply **B**.

IMPORTANT:

DO NOT PLUG THE BASE INTO THE AC OUTLET YET.

- 9 Insert DC Power Cord **H** from base into the power supply **B**.

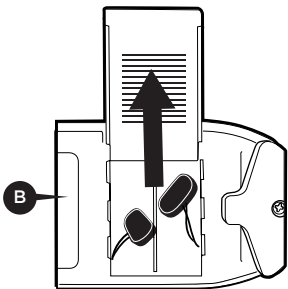

- 10 Turn the power supply **B** upside down to access the battery cover, then slide the battery cover off.

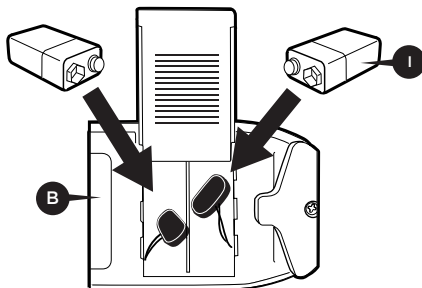

- 11 Insert the two 9V batteries **I** (included) into the compartment and slide the cover back on.

NOTE:

The battery backup will allow for the bed to be lowered if a power outage occurs. It is not recommended to do anything except lower the bed, as the battery backup will not last if the features are continually used.

Assembly – Base (cont'd)

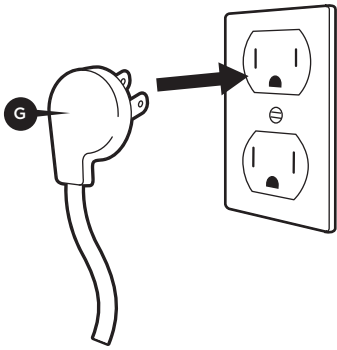

- 12** Insert AC plug **G** into an AC outlet having 100-240V AC, 50/60Hz. Avoid outlets that work only with light switch.

- 13** Lift the remote battery cover and insert the three AAA size batteries **J** (included) into the remote as shown. Replace the battery cover. Remote is already linked with the base.

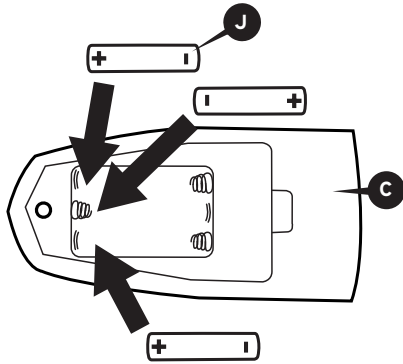

NOTE:

If the remote is not linked, see page 16.

When setting up a Split Cal King or two Twin XL beds to form a King, refer to the instructions on page 14 for connecting and pairing two bases to act as one.

- 14** Raise HEAD and FOOT Sections fully. Lay Base flat on foundation or platform bed.

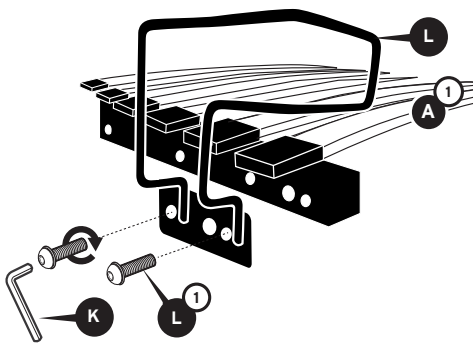

- 15** Install Mattress Retainer brackets **L** on foot section.

NOTE:

If connecting (2) Twin XL/Split Cal Kings to form (1) King base only (2) Mattress Retainer Brackets needed on outside corners.

Assembly – Base (cont'd)

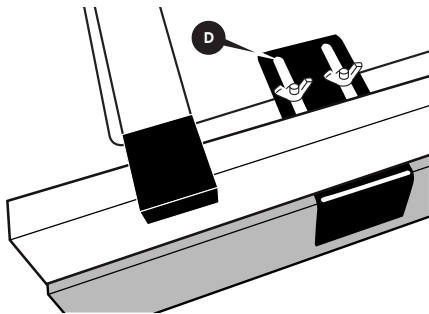

16 FOR FOUNDATION OR BOX SPRING:

If installing base on a foundation, connect the four brackets **D** with wing nuts to the slotted plates in downward position as shown. Tighten the wing nuts and make sure brackets are installed flush with the edge of the foundation or box spring.

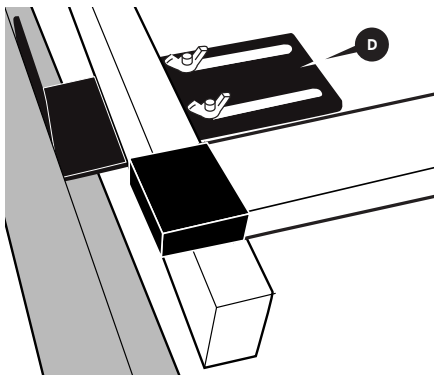

FOR PLATFORM BED:

If installing base on a platform bed, connect the four brackets **D** with wing nuts to the slotted plates in upward position as shown. Tighten the wing nuts and make sure brackets are installed flush with the edge of the platform bed.

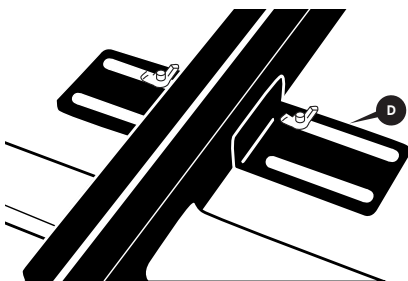

17

INSTRUCTIONS FOR CONNECTING 2 BASES

Connect the connector plate **N** with 2 wing nuts as shown in illustration (as shown) to secure bases together. Tighten the wing nuts.



- (1) Connector Plate with
- (2) Wing Nuts

(Twin XL/Split Cal King Only)

Assembly – Connecting Bases

These instructions are for CONNECTING and PAIRING 2 BASES TO ACT AS ONE - for example, connecting two TWIN XL OR SPLIT CAL KING BASES TO FORM A KING OR CAL KING:

To assemble, please perform the following steps:

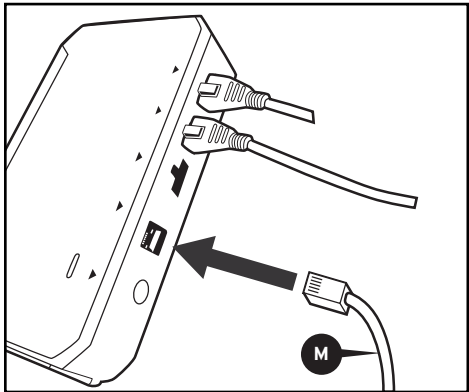

- 1** Lift the HEAD section of each base. Connect the sync cable **M** to the control box of one of the bases.

Connect the other end of sync cable **M** to the control box of other base making sure to route the sync cable thru the wire harness clips on both bases.

NOTE:

Install parts **O**¹ retainer pin and **O**² bolt in the HEAD SECTIONS of the bases as shown.

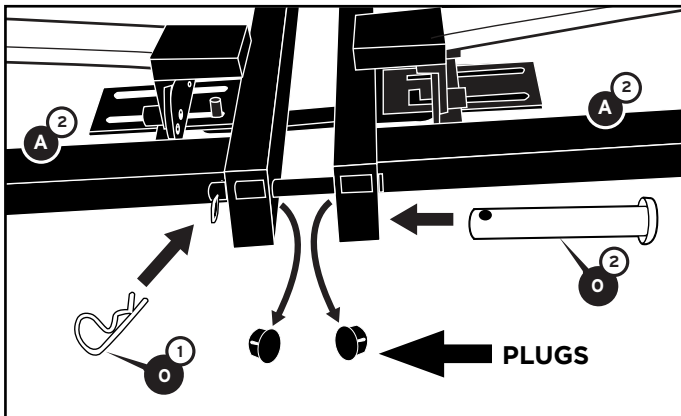

- 2** Remove plastic plug to expose holes in the HEAD of the Freestyle bases.
- 3** Place the two TXL or 2 SCK bases on foundation or platform bed.
- 4** Insert bolt through holes in both bases.
- 5** Insert retainer pin through hole in bolt.

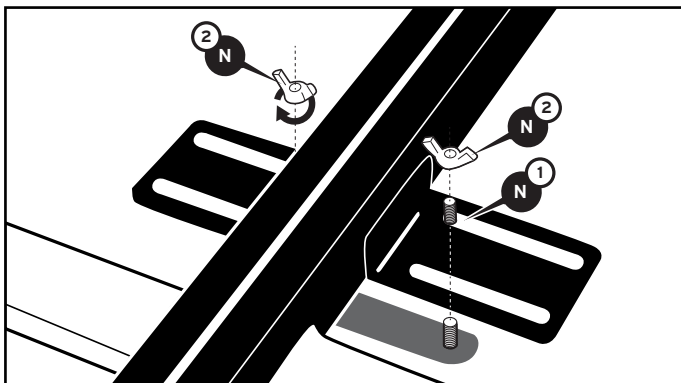

- 6** To connect frames together, locate the frame plates under the HEAD and FOOT sections of the adjoining bases.
- 7** Place connector plate **N**¹ under the frame plates so that the bolts are facing up.
- 8** Install and tighten the wing nuts.

Location of Controls – Remote

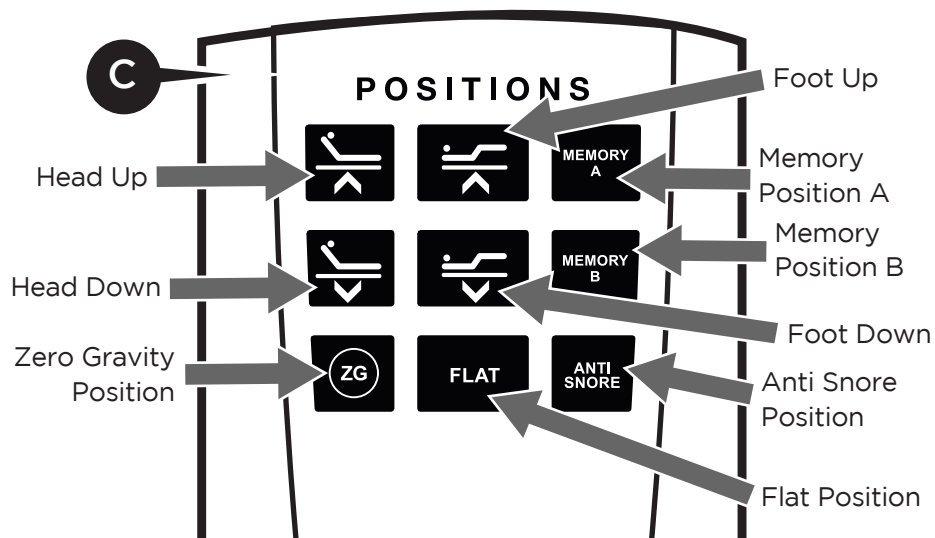

Operation – Main

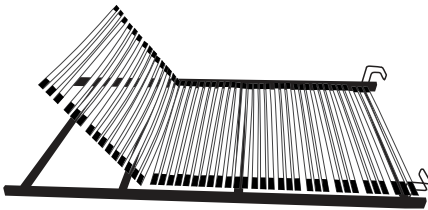

Press and hold the Head Up button to raise the Head position. Release button when desired position is reached.

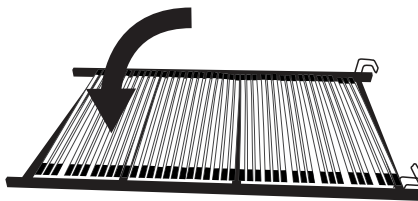

Press and hold the Head Down button to lower the Head position. Release button when desired position is reached.

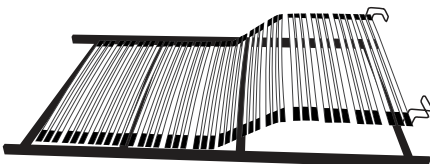

Press and hold the Foot Up button to raise the Foot position. Release button when desired position is reached.

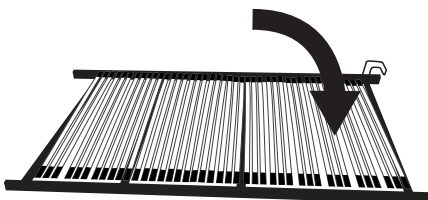

Press and hold the Foot Down button to lower the Foot position. Release button when desired position is reached.

Operation — Main (cont'd)

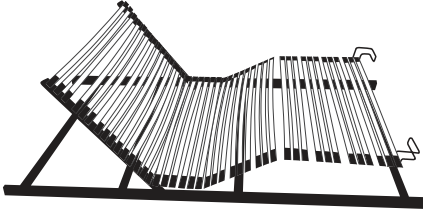

Press the Zero Gravity button and the Head/Foot positions will go to the Zero Gravity position. This action can be stopped at any time by pressing another button.



Press the ANTI-SNORE button and the Head position will go to the Anti-Snore position. This action can be stopped at any time by pressing another button.

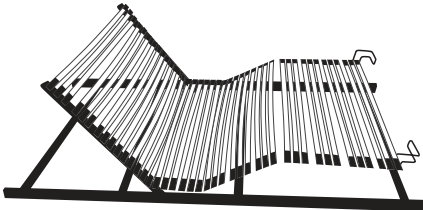

Memory A and Memory B buttons are programmable memory positions. To program these buttons, simply adjust the Head and Foot sections to the desired position. Press and hold the Memory A or Memory B button until the backlight of the remote flashes. The position is now saved.

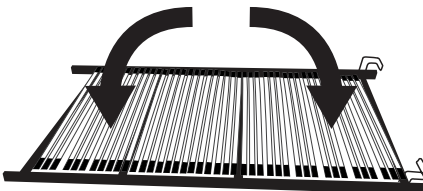

Press the FLAT button and the head and foot will return to the FLAT position. This action can be stopped at any time by pressing another button.

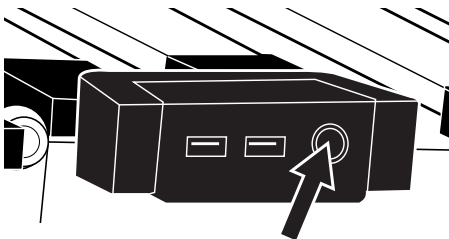

NOTE:

EMERGENCY STOP: Press the SYNC button on the side of the base - base will stop.

Operation – Linking the Remote

Connecting 1 Remote to 1 Base

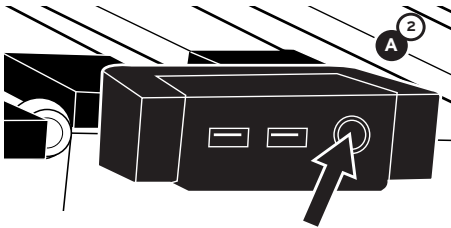

1 Press and hold the SYNC button (round button on side of bed) for 5-10 seconds.

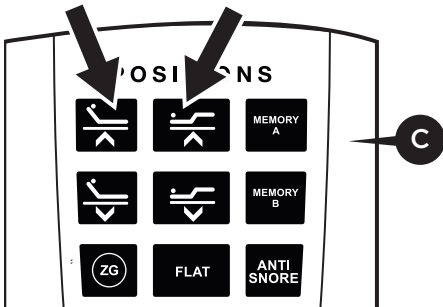

2 Then simultaneously press and hold HEAD UP and FOOT UP buttons. The remote backlight will flash. When lights turn off, remote should be sync'd.

3 Test to confirm. Repeat if no function.

Troubleshooting

In the event the Comfort Base's base fails to operate, investigate the symptoms and possible solutions provided below:

Remote control illuminates and appears to be operable, but no features of the base will activate.

- Unplug power cord, wait 30 seconds and plug in to reset electronic components.
 - Defective surge protection device or electrical outlet. Test outlet by plugging in another working appliance.
 - Electrical circuit breaker may be tripped. Check electrical service breaker box to verify.
 - Re-link the remote control (see Remote Control Re-Linking section of this manual for programming procedures).
 - Replace batteries in the remote control & relink remote control.
-

Remote control will not illuminate.

- Replace batteries in the remote control.
-

Head section will elevate, but will not return to the horizontal (flat) position.

- Base mechanism may be obstructed. Elevate base and check for obstruction. Remove obstruction.
 - Headboard may be too close to the edge of the mattress. Verify that distance between headboard brackets and mattress is sufficient. Adjust if required.
-

Head or Foot Lift Function has minor interference during operation.

- Check batteries in remote, replace if necessary.
 - Make sure that you are following the duty cycle of the motor (do not operate more than one (1) minute over an eight (8) minute period, or approximately a 12% duty cycle).
 - Press the lift buttons squarely and accurately.
 - Control box may be experiencing common Radio Frequency Interference from other radio transmitting devices (see Remote Control Re-Linking section).
-

Troubleshooting (cont'd)

In the event the Comfort Base's base fails to operate, investigate the symptoms and possible solutions provided below:

Zero-Gravity button needs to be re-programmed back to factory settings.

- The Zero-Gravity button is a pre-set position button on your remote. This button has the ability to be re-programmed to a different position. To change the setting follow the above instructions on programming the memory buttons. If you would like to re-set the button back to the original factory settings follow the below instructions.
 - (1) Raise Head to 17 degrees. (2) Raise Foot to 25 degrees. (3) Press and hold Zero Gravity button until the remote starts to flash. (4) Release the button. (5) The position is now saved.
-

Resources

CUSTOMER SERVICE

1-855-581-3095

VISIT US ONLINE

glideaway.com

FREESTYLE 2.0

Sleep Well. Live Better. Be Your Best.

