

SMOOTH OPERATOR



STRUCTURE: metal.

SEAT UPHOLSTERY: expanded polyurethane of varied densities (D35EM + OS40M + D50 mind foam) covered with synthetic lining 6mm and 230gr.

ARM AND BACK UPHOLSTERY: expanded polyurethane of varied densities (HT45 + 40P + D35EM + D18CDSS) covered with downproof white cotton cover filled with 100% natural feathers.

SEAT HEIGHT: 42 cm - 45 cm with feet h. 19,5 cm.

ARM HEIGHT: 68 cm (minimum) - 85 cm (maximum).

FEET: metal, finishes black nickel or titanium or varnished micaceous brown or oxy grey, h.16,5 cm.

On request feet can be supplied 3 cm higher by using spacers that may be at sight, with an extra charge.

ATTENTION: please specify the fabric or leather colour of the back cushion stripes.

CLEANING INSTRUCTIONS: if the stripes are covered with leather B/3155-3156-3157-3158, there is no cleaning procedure that can be used.

For all the other leathers of Arketipo collection the cover can be dry cleaned in specialized laundries. If two fabrics have different cleaning procedures, please follow the most restrictive one.

STRUCTURE: métal.

REMBOURRAGE ASSISE: polyuréthane expansé de différentes densités (D35EM + OS40M + D50 mind foam) recouvert de petit velours 6mm et 230gr.

REMBOURRAGE DOSSIER ET ACCOUDOIR: polyuréthane expansé de différentes densités (HT45 + 40P + D35EM + D18CDSS) recouvert de coton blanc 100% imperméable aux plumes, remplissage en plume 100% naturelle.

HAUTEUR ASSISE: 42 cm - 45 cm avec pieds h. 19,5 cm.

HAUTEUR ACCOUDOIR: 68 cm (minimum) - 85 cm (maximum).

PIEDS: métal, finitions: black nickel ou titane ou teinté marron micacé ou oxy grey, h. 16,5 cm.

Sur demande on peut avoir des pieds plus hauts de 3 cm en insérant des entretoises qui pourraient être visibles, avec supplément.

ATTENTION: Il faut indiquer le tissu ou le cuir des bandes des dossiers.

INSTRUCTIONS DE NETTOYAGE: si les bandes sont réalisées en cuir B/3155-3156-3157-3158, la housse ne peut pas être nettoyée ni à sec ni lavée.

Si les bandes sont dans les autres cuirs de la collection Arketipo, la housse peut être nettoyée à sec chez des pressings spécialisés. Si deux tissus ont des procédés de nettoyage différents, nous vous prions de suivre le plus restrictif.

Sofa

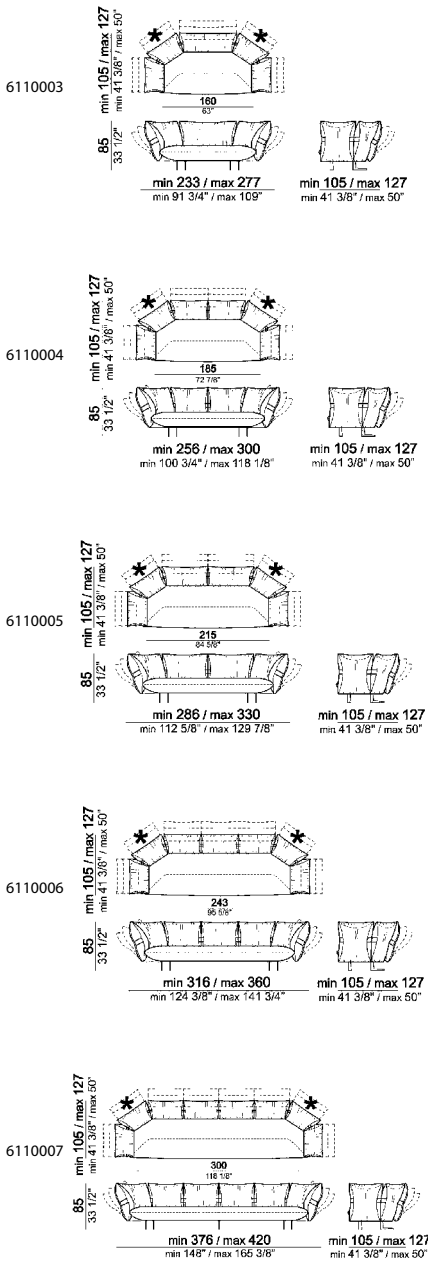

Right or left unit - depth 128/150 cm

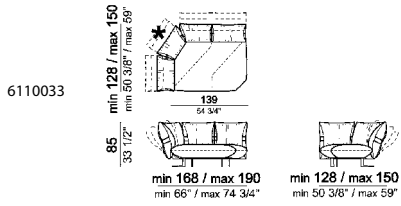

Right or left unit

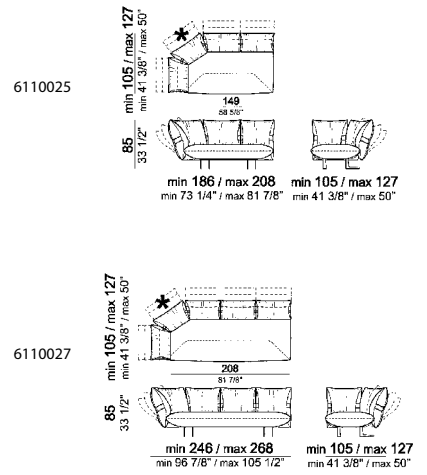

Unit with 3 back cushions and right or left pouf

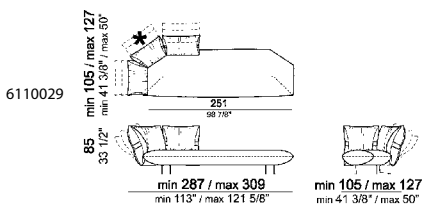

Unit with 4 back cushions and right or left pouf

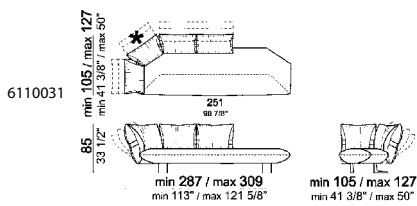

Dormeuse right or left

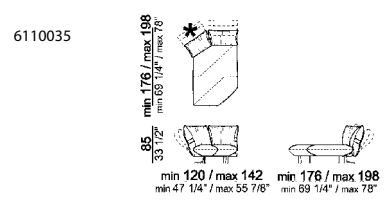

Chaise-longue with right or left short arm

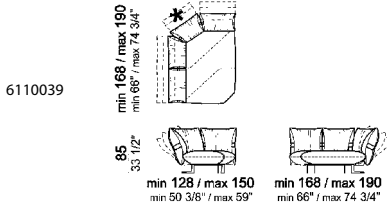
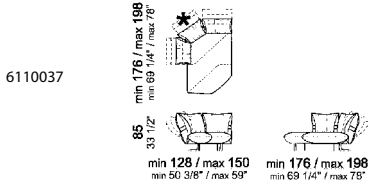

Central unit

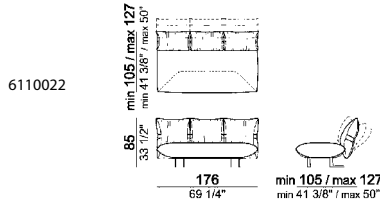
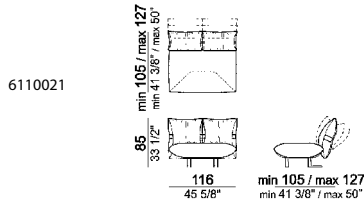

Pouf

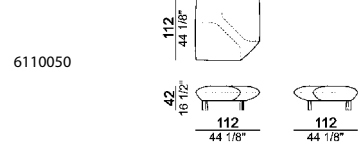

Cushion



Composition "A"

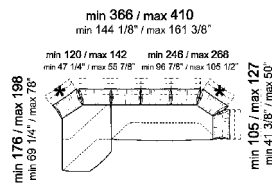

Composition "B"

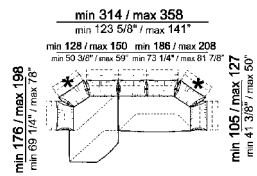

Composition "C"

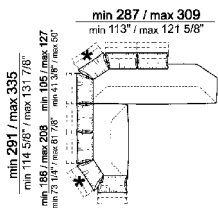

Composition "D"

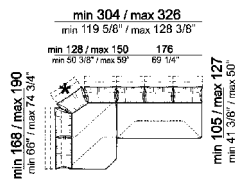

Composition "E"

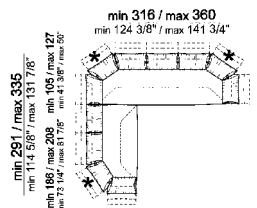

Composition "F"

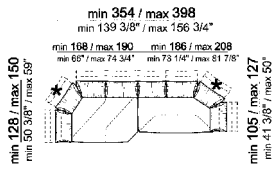

Composition "G"

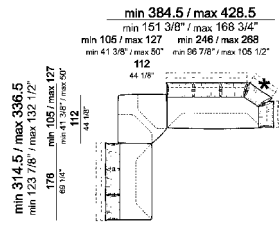

Composition "H"

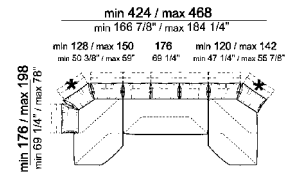

smoothnota2

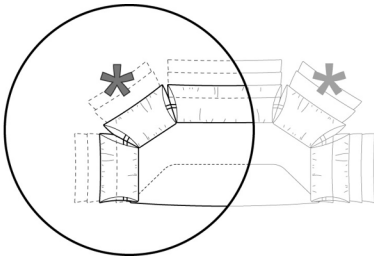

smoothnota1

