EC9255

La Specialista

ARTE

COFFEE MAKER
Instructions for use



DeLonghi

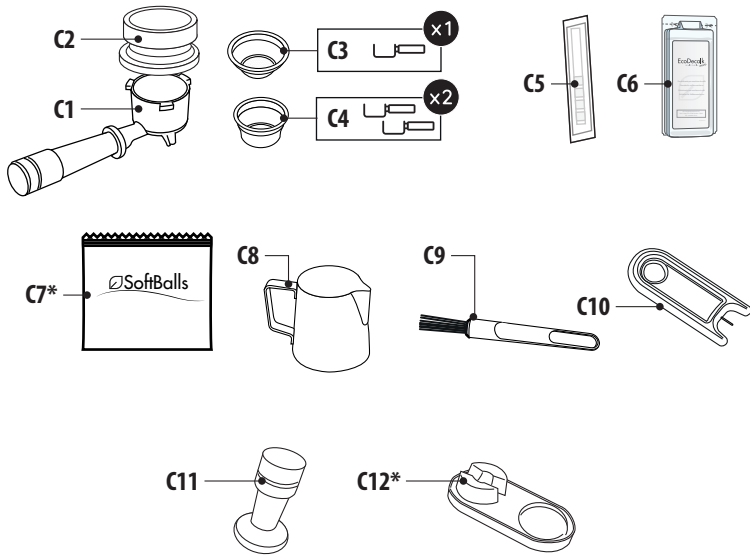
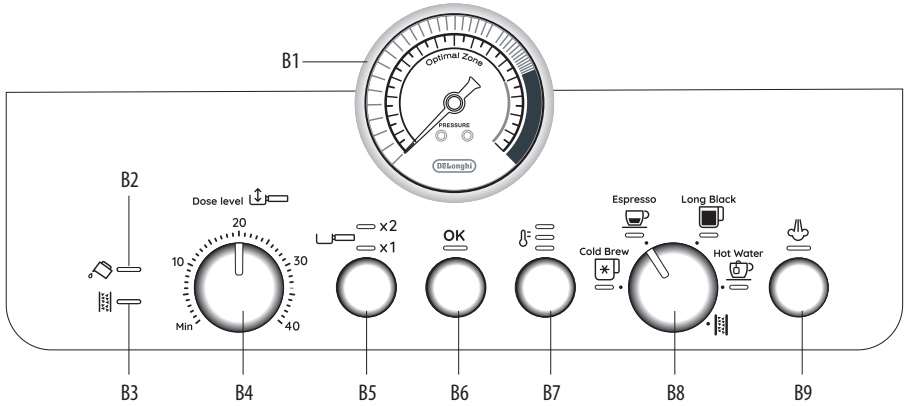
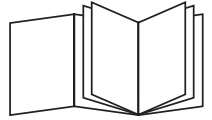

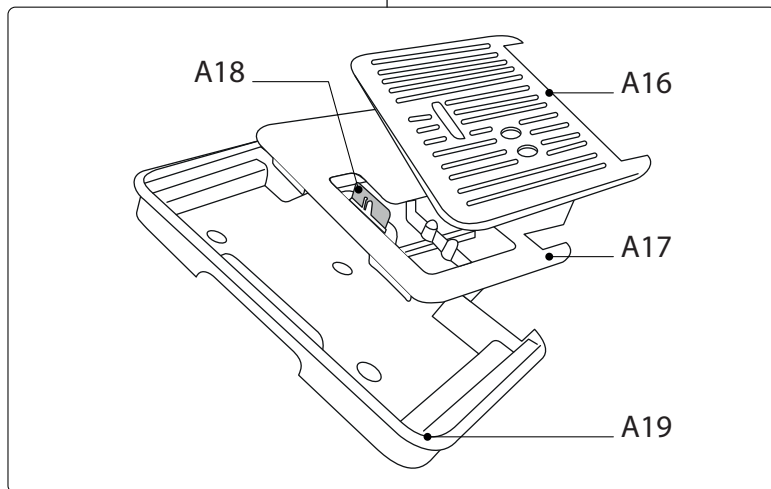
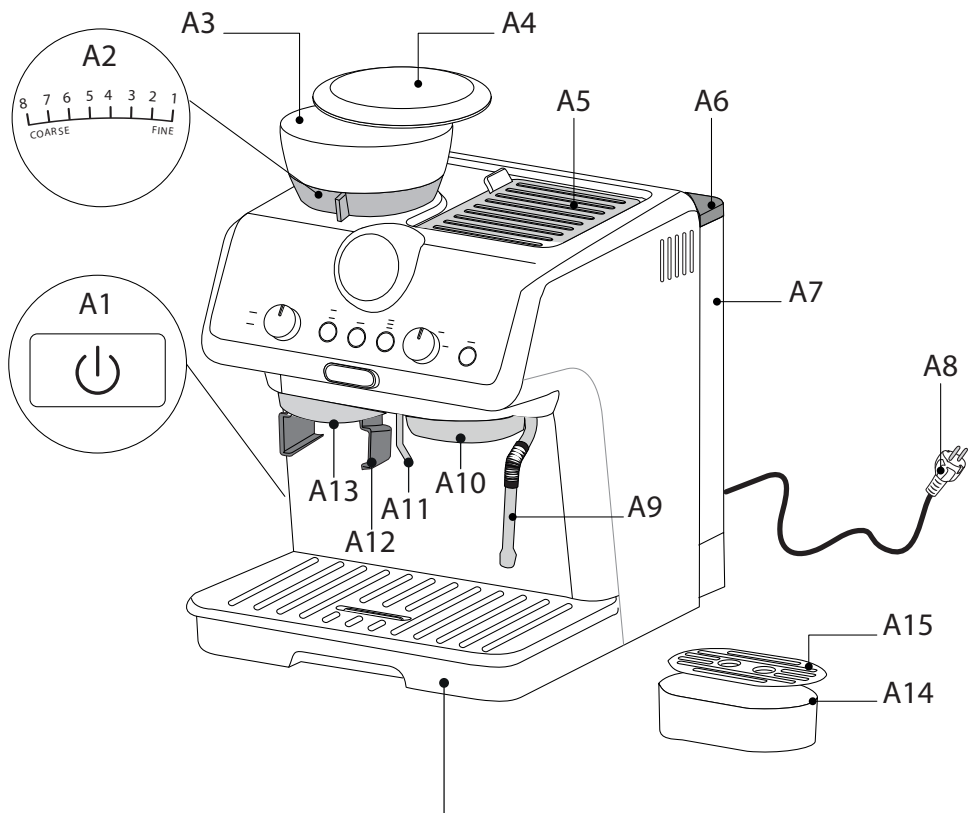

Before using the appliance, always read the safety warnings.

This appliance shall not be used by children.
Keep the appliance and its cord out of reach of children.

1. DESCRIPTION

1.1 Description of appliance - A

- A1. Main switch
- A2. Grinding level selector (fine to coarse)
- A3. Beans container
- A4. Beans container lid
- A5. Accessory holder lid
- A6. Water tank lid
- A7. Water tank
- A8. Power cord
- A9. Steam wand
- A10. Coffee outlet
- A11. Hot water spout
- A12. Portafilter holder
- A13. Coffee grinder outlet
- A14. Small cup grille support
- A15. Small cup grille
- A16. Mug or cup tray
- A17. Mug or cup tray support
- A18. Water level indicator
- A19. Drip tray

1.2 Description of control panel - B

- B1. Pressure gauge
- B2. No water light

- B3. Descale light
- B4. Coffee dose dial
- B5. 1 or 2-cups selection button
- B6. OK button: to deliver the drink/confirm
- B7. Coffee Temperature button
- B8. Mode selector dial:
 - Cold Brew
 - Espresso
 - Long Black
 - Hot water
 - Descaling
- B9. Steam button: to deliver steam

1.3 Description of accessories - C







- C1. Portafilter
- C2. Dosing&Tamping Guide
- C3. 1-cup coffee filter
- C4. 2-cups coffee filter
- C5. "Water hardness test" indicator paper
- C6. Descaler
- C7. Softballs (* some models only)
- C8. Milk pitcher
- C9. Cleaning brush
- C10. Cleaning needle for steam nozzle
- C11. Tamper
- C12. Tamping Mat (* some models only)











1.4 Recommended optional cleaning accessories

Visit Delonghi.com for more information.





 **Cleaner**
EAN: 8004399333307

2. EXPLANATION OF LIGHTS

LIGHTS	EXPLANATION OF LIGHTS	OPERATION
All the lights flash briefly	Turning the machine on	Self-diagnosis
 OK On	The appliance is being turned on for the first time and the water circuit must be filled	Proceed as described in the Quick start guide.
 Flashing	The machine is warming up	Wait until the ideal delivery temperature has been reached
 White OK On  (The indicators  and  show the respective selections)	The machine is ready to use	Prepare the machine, select the desired drink and press OK to start delivery
...→		

LIGHTS	EXPLANATION OF LIGHTS	OPERATION
 <p>On</p> <p>(The indicator  shows the current selection)</p>	The machine is ready to deliver Cold Brew	Prepare the machine and press OK to start delivery
	Insufficient water in tank (A7) or water tank not inserted correctly	Fill the tank or extract the tank and put it back correctly
 <p>Flashing</p>	You are trying to deliver a drink but water tank (A7) is empty	Fill the tank
	Because the beans are too finely ground, the coffee is delivered too slowly or not at all	Remove the portafilter (C1) and repeat the operations to make the coffee, bearing in mind the instruction given in the quick start guide relative to the grinding section
	The filter (C3) or (C4) is blocked	Clean as described in section “5. Cleaning and maintenance”.
	The tank (A7) has been inserted incorrectly and the valves on the bottom are not open	Press the tank down lightly to open the valves on the bottom
	1-dose drink is selected	All the process (from grinding to delivery) is setted for preparing 1 cup
	2-doses drinks are selected	All the process (from grinding to delivery) is setted for preparing 2 cups
 <p>On</p>	Choose 1 of the 3 temperatures available	See Quick Guide for tips.
 <p>Flashing</p>	General alarm	Turn the machine off and wait 10 minutes before turning on again. If the problem continues, contact customer services.
 <p>Flashing</p>	Steam function is selected and running	In a few seconds the appliance starts steam delivery
 <p>On - red</p>	Descaling must be performed	Descalc the appliance as described in section “9. Descaling”

...→

LIGHTS	EXPLANATION OF LIGHTS	OPERATION
 <p>Flashing - On</p>	Descaling is selected	Press OK (B6) to run descaling cycle or turn the selection knob to the drink desired
 <p>Flashing</p>	Descaling proceeds. The machine delivers descaling solution	Proceed by completing the descaling cycle (see "9. Descaling")
 <p>Flashing - On</p>	The first phase of the descaling cycle is complete. You now need to proceed with rinsing.	Press OK to start rinsing.
 <p>Flashing</p>	The machine proceeds with the rinsing phase to complete the descaling cycle.	Proceed by completing the descaling cycle (see "12. Descaling")

3. MENU SETTINGS

Enter the setting menu

Press both buttons (B5) and (B7) for 3 seconds to enter setting menu

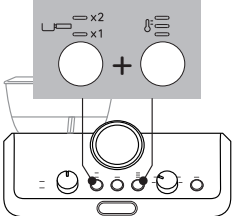

Reset to default values

Keep pressed steam button (B9) for 3 seconds

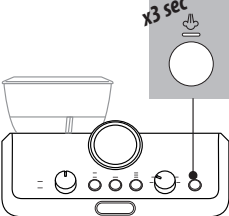

Select the setting

Turn the knob (B8) to select the position corresponding to the function to set

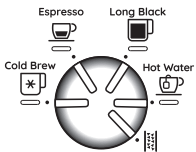

Cold Brew

Espresso

Long black













Hot water



Press the temperature button: the light corresponding to the current setting flashes.

Press the temperature button again to change the setting:



<p>Statistics</p> <p>For Servicing Purposes Only (see par. "10.1 How to read the statistics")</p>	<p>Pre-infusion delay</p> <p> → No</p> <p> → 1 sec</p> <p> → 2 sec</p>	<p>Extra grinding adjustment</p> <p> → 1st range</p> <p> → 2nd range</p>	<p>Auto off</p> <p> → 9 minutes</p> <p> → 1,5 hours</p> <p> → 3 hours</p>	<p>Water hardness</p> <p> → soft</p> <p> → medium</p> <p> → hard</p>
--	--	---	---	--



Save new settings:

Press the **OK** (B6) button to confirm.

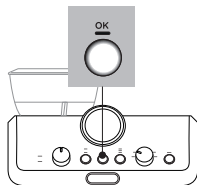

Please note:

The appliance automatically exits the menu setting after 30 seconds of inactivity



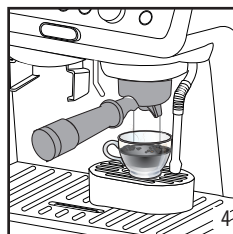
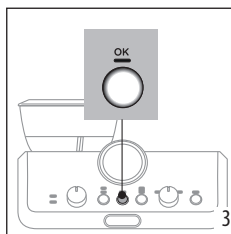
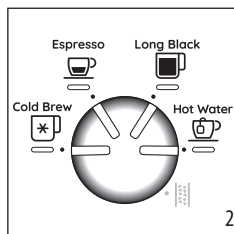
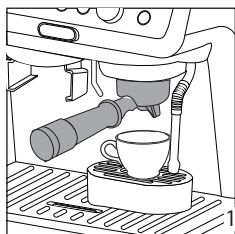



4. CUSTOMISING THE QUANTITY OF DRINKS



1. Prepare the appliance to deliver the drink you want to make. Prepare the coffee dose and attach the portafilter (C1) to the coffee outlet (A10).
2. Turn the dial (B8) to select the drink to be programmed.
3. Keep pressed for at least 3 seconds OK button (B6) until the light relative to the drink to programme flashes. Delivery starts.
4. Once reached the desired quantity in cup, press the OK button again. The quantity is programmed.

Please note:

- You can programme drinks quantities, but not steam.
- Programming changes the quantity of the drinks, but not the amount of coffee ground.
- "X2" drinks can be programmed separately.

Selectable Drink	Default quantity	Programmable quantity
Cold Brew 	110 ml	from 90 to 130 ml
Cold Brew 	180 ml	from 160 to 220 ml
Espresso 	35 ml	from 25 to 90 ml
Espresso 	70 ml	from 50 to 180 ml
Long black 	100 ml	<ul style="list-style-type: none"> • water: from 25 to 120 ml • espresso: from 25 to 60 ml
Long black 	200 ml	<ul style="list-style-type: none"> • water: from 50 to 240 ml • espresso: from 50 to 120 ml
Hot water 	250 ml	from 65 to 300ml









5. CLEANING AND MAINTENANCE

Important!

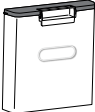
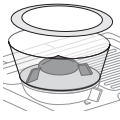
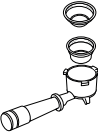
- Do not use solvents, abrasive detergents or alcohol to clean the coffee machine.
- Do not use metal objects to remove encrustations or coffee deposits as they could scratch metal or plastic surfaces.
- If the appliance is not used for more than a week, before using it again, we recommend you perform a rinse cycle.

Danger!

- While cleaning, never immerse the coffee maker in water. It is an electrical appliance.
- Before cleaning the outside of the appliance, turn it off, unplug from the mains socket and allow to cool.

						
	×	✓	×	×	×	×
	✓	×	✓	×	×	×
	✓	×	✓	×	✓	×
	×	✓	✓	✓	×	✓
	×	✓	✓	✓	×	✓

6. CLEANING THE GRINDER

1. Clean the attachment area with the brush (C9);
2. Use the brush to clean the coffee funnel.

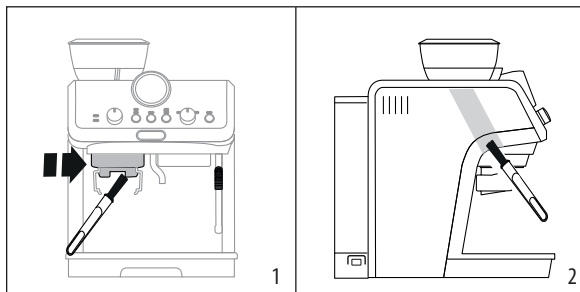

7. WATER HARDNESS

7.1 Water hardness



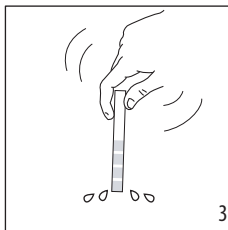
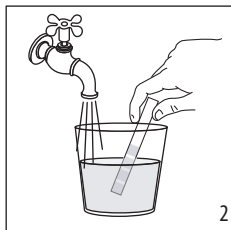
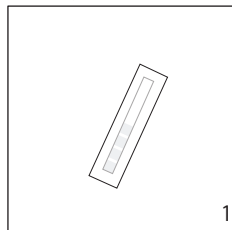



The  descale light (B3) comes on after a period of time established according to water hardness. The machine can also be programmed according to the actual hardness of the water supply in the various regions, in which case descaling may be required less frequently.



1. Remove the "TOTAL HARDNESS TEST" indicator paper (C5) from its pack.
2. Immerse the paper completely in a glass of water for one second.
3. Remove the paper from the water and shake lightly.

4. Set the appliance as indicated in section "3. Menu settings".

After about a minute, 1, 2, 3, or 4 red squares form, depending on the hardness of the water. Each square corresponds to one level.

Total Hardness Test result	Button	Level
		1 soft water
		2 medium water
		3 hard or very hard water
		

8. CLEANING THE STEAM NOZZLE

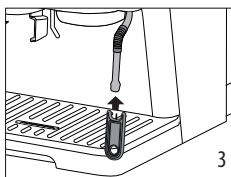
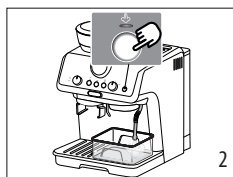
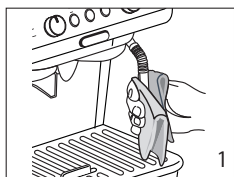

1. After every use, remove with a soft damp cloth any milk residues from the steam wand (A9) and the nozzle.
2. Use the steam for a deeper cleaning.
3. To maintain the better usability of the nozzle, when clogged, use the Cleaning Tool (C10) for opening the hole.

9. DESCALING

≈40
Minutes



EcoDecalk
mini
100 ml C°/3,40 fl.oz.

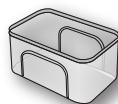

2L

Please note

- Before use, read the instructions and the labelling on the descaler pack.
- It is important to use De'Longhi descaler only. Using unsuitable descaler and/or performing descaling incorrectly may result in faults not covered by the manufacturer's guarantee.
- Descaler could damage delicate surfaces. If the product is accidentally spilt, dry immediately.

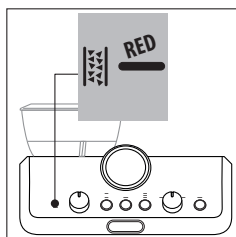

When the  light (B3) comes on, it is time to proceed descaling the machine. The descaling cycle can be run in any moment.

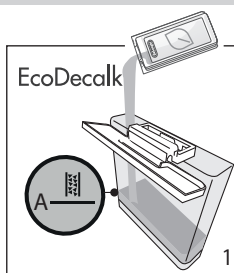

1. (IF PRESENT, REMOVE THE WATER SOFTENER DEVICE). Pour the descaler into the tank (A7) up to the level  A marked inside the tank (equal to one 100ml packet).

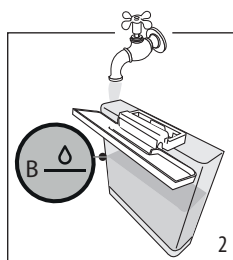

2. Add water (1 liter) up to the level  B. Then put the water tank back in the appliance.

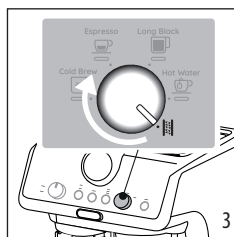

3. Turn the mode selector dial (B8) to : the descaling light (B3) flashes.

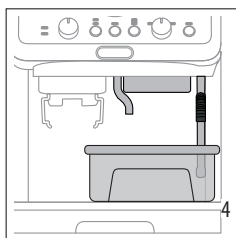

4. Make sure the portafilter is not attached and position a recipient under the coffee outlet (A10), hot water spout (A11) and steam wand (A9).

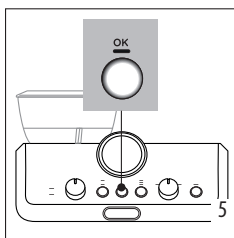

5. Keep pressed for at least 3 seconds the OK button: the OK light begins to flash; descaling starts.

Please note

- In case you start the descaling cycle by mistake, you can press the OK button for 10 seconds; the rinsing cycle can not be stopped (from step 9).
6. The descale programme starts and the descaler liquid comes out of the steam wand and coffee outlet. The descale programme removes limescale deposits from inside the appliance by automatically performing a series of rinses and pauses until the tank is empty.

Delivery stops and the OK light turns to blu. This indicates that it is necessary to proceed with rinsing: see next page.



DESCALING

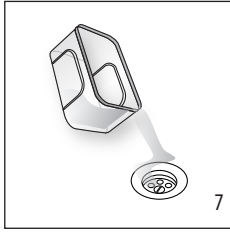

7. Empty the recipient used to collect the descaler solution and replace it empty.

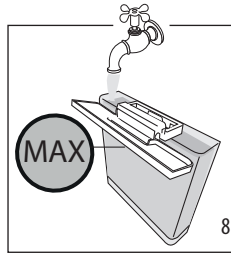

8. Remove the water tank, empty any residues of descaler solution, rinse with running water and fill with fresh water up to the MAX level. Put the tank back in its housing.

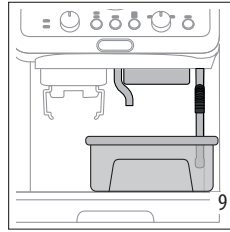

9. Position a recipient under the coffee outlet, hot water spout and steam wand.

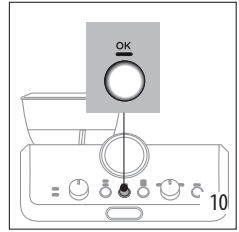

10. Press the OK button: rinsing starts.

11. When rinsing is complete, delivery stops and the appliance prepares to be used again:

12. Empty the recipients used to collect the rinse water.

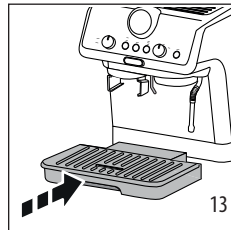

13. Extract and empty the drip tray (A19), then put back in the appliance.

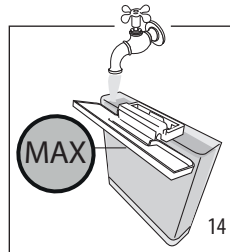

14. Empty, rinse, then fill the water tank with fresh water and replace it.

Now the appliance is ready to use.

11. USING THE SOFTBALLS (*SOME MODELS ONLY)

Softballs is an innovative system that extends the life of the machine, without altering the sensory properties of the water, guaranteeing consistently creamy and aromatic coffee.

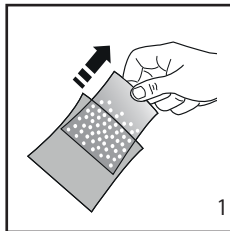

1. Extract the Softballs bag from the packaging.

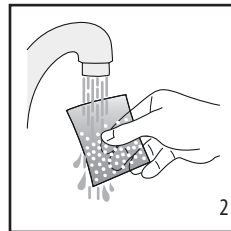

2. Rinse with tap water the Softballs bag.

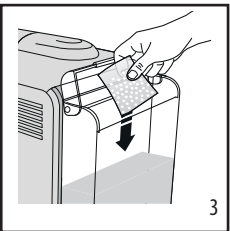

3. Deep the bag into the water tank (A7).

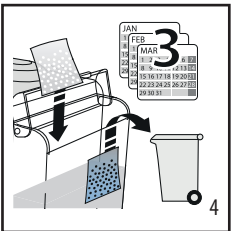

4. Change the Softballs every 3 months.

10. TROUBLESHOOTING



PROBLEM	CAUSE	SOLUTION
There is water in the drip tray (A19)	It is normal: due to the internal water circuits operations	Regularly empty and clean the drip tray
No espresso coffee is delivered	No water in the tank (A7)	Fill the tank
	Only the OK light (B6) is on to indicate that the coffee or steam circuit is empty	Press the button corresponding to the OK light to fill the circuit
	The coffee filter (C3) or (C4) is blocked	Rinse the filters under abundant running water.
	Coffee grind too fine or too much coffee	Adjust coffee dose and grinding (refer to Quick Guide)
	The tank (A7) has been inserted incorrectly and the valves on the bottom are not open	Press the tank down lightly to open the valves on the bottom
	Scale in the water circuit	Descale as described in section "9. Descaling"
The portafilter (C1) cannot be attached to the appliance	The ground coffee has not been pressed or is too much	Repeat grinding with new settings. Reduce the powder quantity: check if the filter (single or double filter) is the same size as the selector of grinding quantity (2x (B5) selected or not)
The espresso coffee drips from the edges of the portafilter (C1) rather than the holes	The portafilter is inserted incorrectly	Attach the portafilter correctly and rotate firmly as far as it will go
	The espresso boiler gasket has lost elasticity or is dirty	Have the espresso boiler gasket replaced by Customer Services
	The coffee filter is clogged	<ul style="list-style-type: none"> Rinse the filters under abundant running water. Reduce the grinding thickness
The coffee crema is too light (delivered from the spout too fast)	The appliance settings need reviewing	Refer to Quick Guide for suggestions
The coffee crema is too dark (delivered from the spout too slowly)	The appliance settings need reviewing	Refer to Quick Guide for suggestions
The coffee is cold	A Cold Brew has been delivered	Keep in mind that the "OK" blue light corresponds to the selection of "Cold Brew"
The Cold Brew is warm	A hot coffee has been delivered before Cold Brew	It is recommended to deliver a "Cold Brew" for a few seconds to make a cool rinse before preparing the drink
	The water in the water tank is not fresh	Empty the water tank and fill it with fresh water
	No ice in the glass	Add 3-4 ice cubes as suggested for Cold Brew
At the end of descaling, the appliance requests a further rinse	During the rinse cycle, the water tank (A7) has not been filled to the MAX level	Complete the rinse cycle from point (8) of section "9. Descaling"
		...→



PROBLEM	CAUSE	SOLUTION
The appliance does not grind the coffee	There is foreign matter that cannot be ground in the coffee grinder	Turn the grinder selector (A2) to 8, vacuum all the beans and particles in the beans container (A3). If the problem persists, address to Customer Service Centre.
If you want to change the type of coffee	You must remove all the beans present in the machine	<ul style="list-style-type: none"> Empty the beans container (A3) (if necessary, operate the coffee mill without beans or use a vacuum cleaner to remove any remaining beans) Attach the portafilter (C1) and operate the coffee mill a number of times without beans to free the grinder. Attach the portafilter to the outlet of the grinder (A13). Push the portafilter to start grinding: it stops automatically. Repeat until the filter is empty Place the new coffee in the beans container If the amount of coffee ground is not enough to reach the perfect dose, proceed setting the appliance as for the first use
After grinding, the coffee filter is empty	The coffee grinder funnel is clogged	See section "6. Cleaning the grinder".
After grinding, the ground coffee in the filter (C3) or (C4) does not reach the "perfect dose"	The quantity of ground coffee needs adjusting	Adjust the quantity of coffee with the dial (B4). If the dial is already in the max. position, select the second range of grinding adjustment (see "3. Menu settings" - "Extra grinding adjustment").
	You are using the 2 cup filter (C4)	Make sure the 2X light is on
	Over time the burrs wear down	Address to a Customer Service Centre to change burrs.

10.1 How to read the statistics







When you contact the Customer Service Centre, the statistics info could be useful. Please follow this procedure:









- Enter the menu by pressing both buttons (B5) and (B7) for 3 seconds;
- Turn the knob (B8) to select "Cold Brew" position;
- Press the temperature button (B7);
- Once entered in the menu select the desired data rotating the function knob according to the next chart:

Knob position	Counter
Cold Brew 	Total count of Cold drinks
Espresso 	Total count of Hot drinks
...→	

Knob position	Counter
Long black 	Total count of Steam preparations
	Total count of Descalings

- Check the lights corresponding to , ,  to read the statistics:

Lights on control panel	Beverage count	Descal count
 x2  x1 	Up to 100	Up to 1
 x2  x1 	Between 100 - 1000	Between 2 - 10
...→		

Lights on control panel	Beverage count	Descale count
 OK 	Between 1000 - 3000	Between 10 - 30
 OK 	Between 3000 - 6000	Between 30 - 60
 OK 	Between 6000 - 11000	Between 60 - 110
 OK 	More than 11000	More than 110

- After 30 seconds of inoperation, the machine automatically exits from the menu setting and it is ready to use.

Register Now 
www.delonghi.com/register

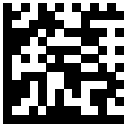

57132C8203_00_1022