

---

FH2184 FH2394

IDEAL FRY



---

**DeLonghi**

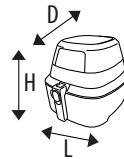
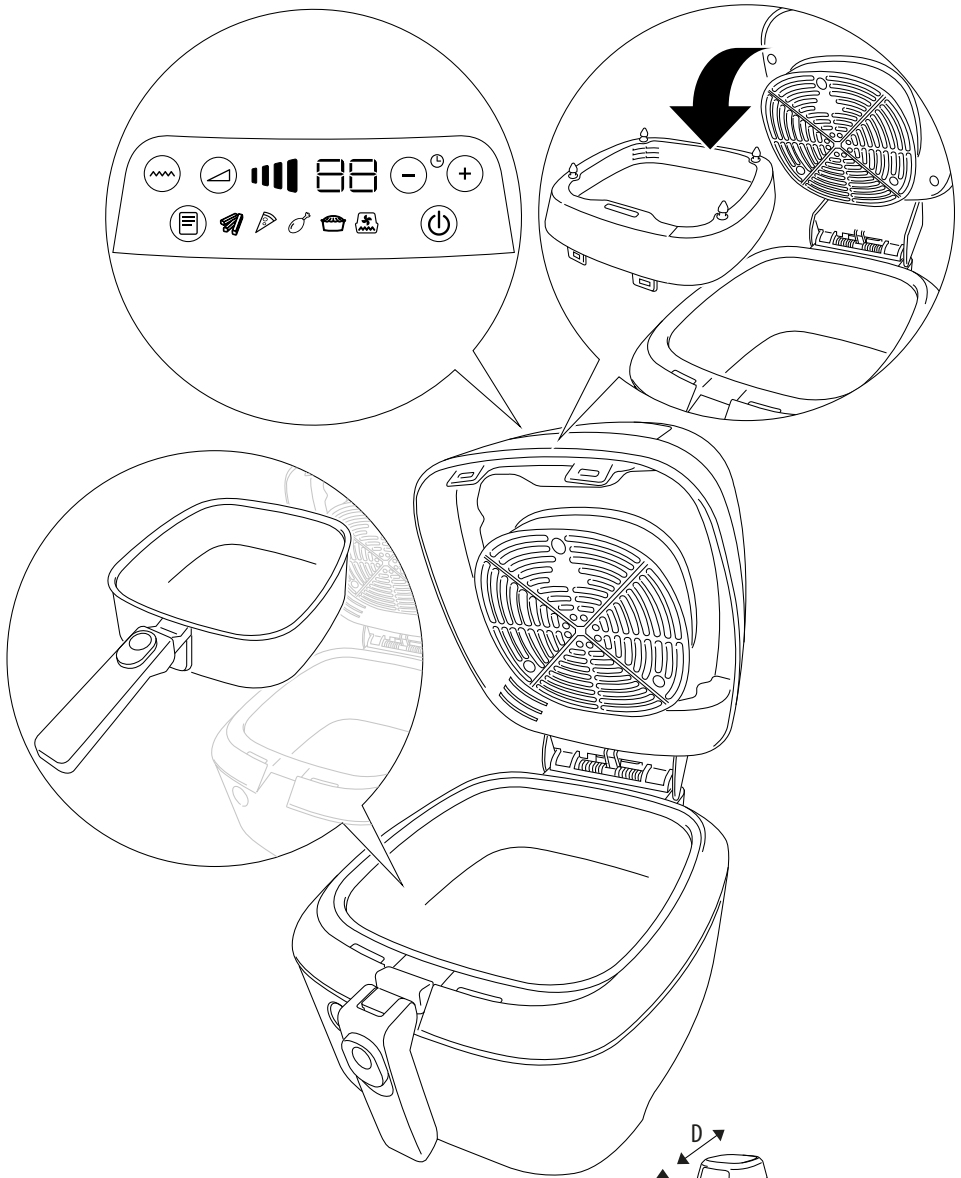

(LxHxD):	FH2184 27.5x27.5x37.5 mm
	FH2394 27.5x29.5x37.5 mm
	FH2184 5.1 kg
	FH2394 5.6 kg

For more recipes:  
(free download)



De'Longhi Recipes



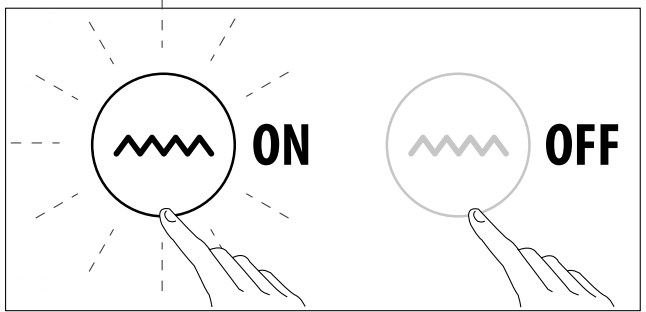
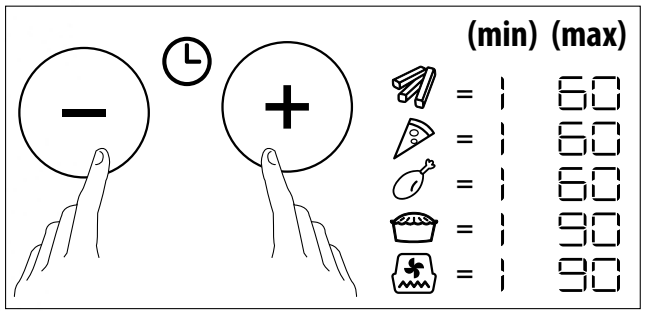
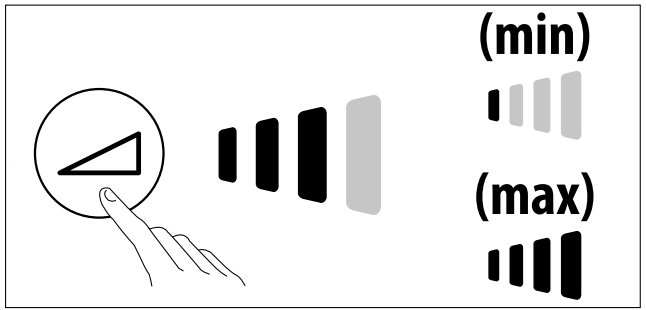
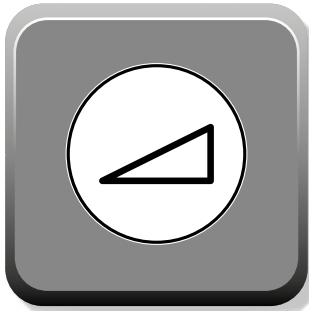
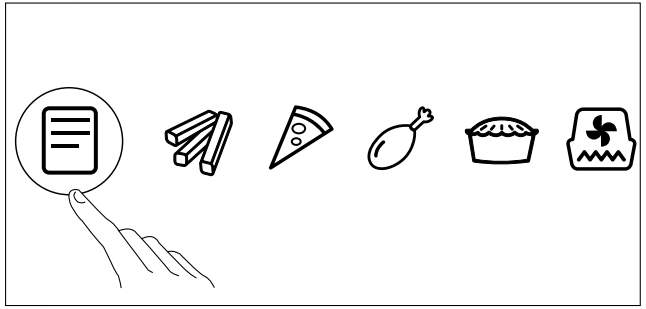

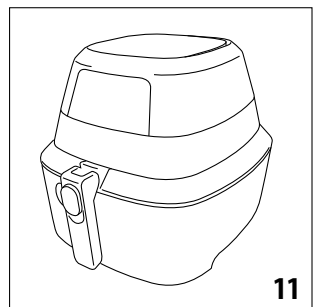
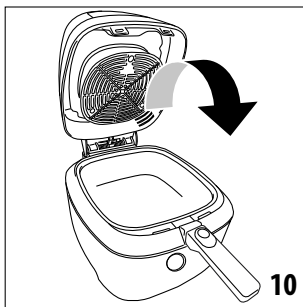
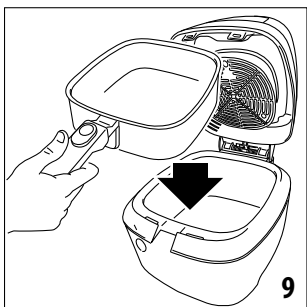
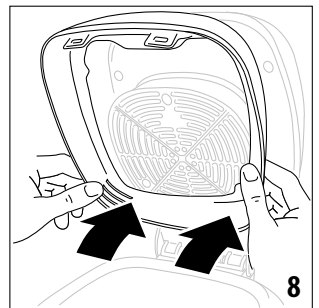
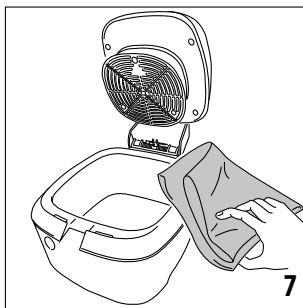
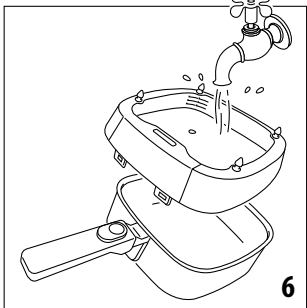
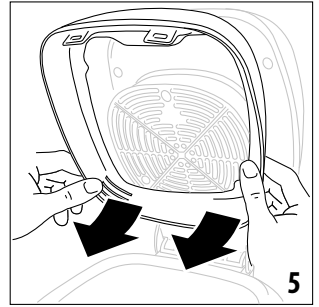
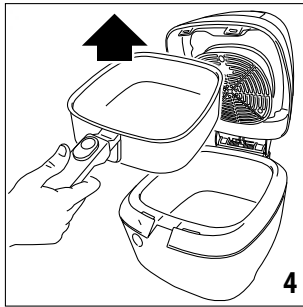
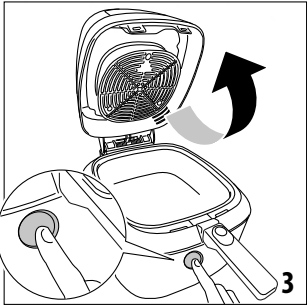
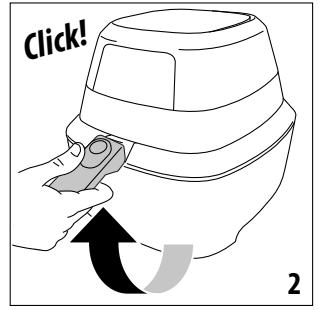
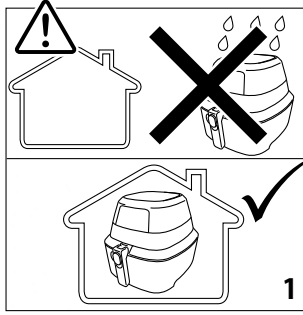

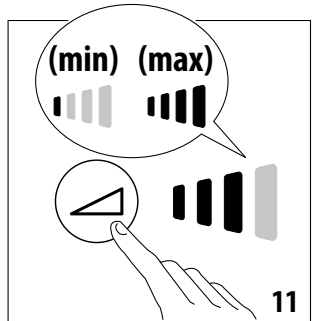
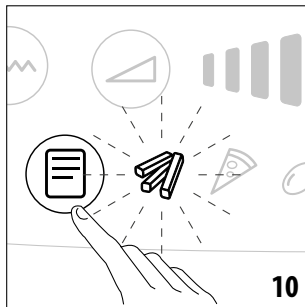
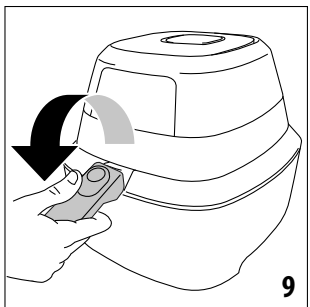
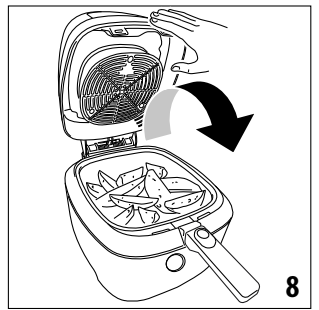
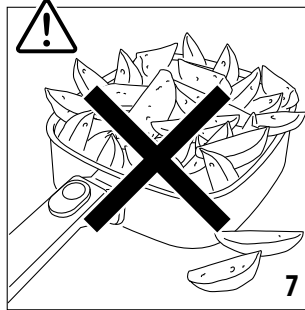
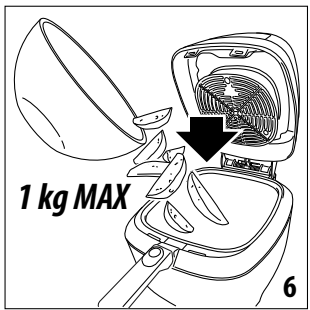
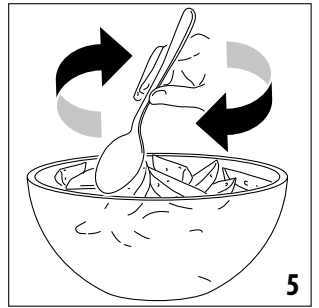
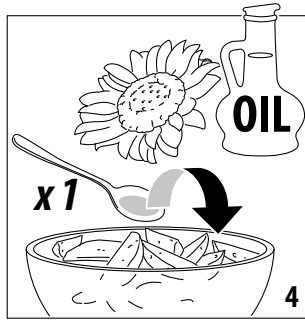
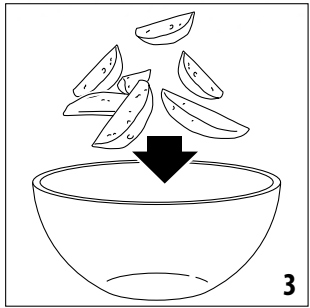
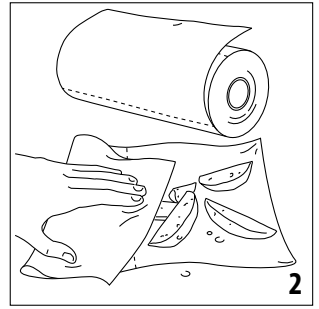
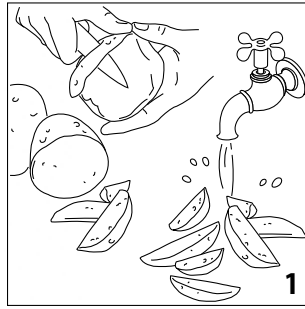

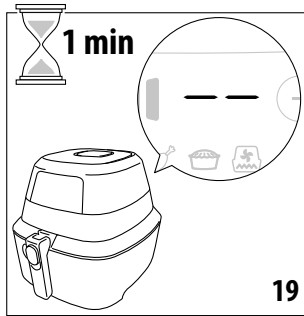
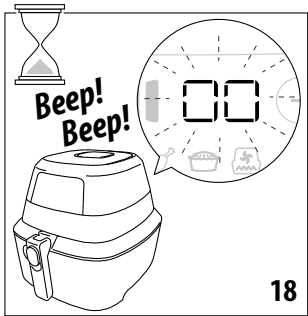
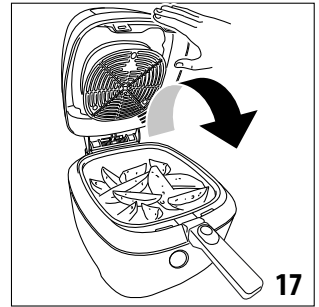
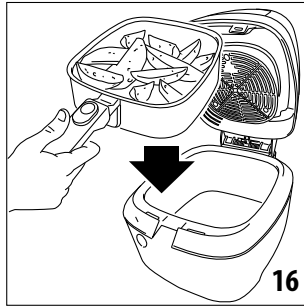
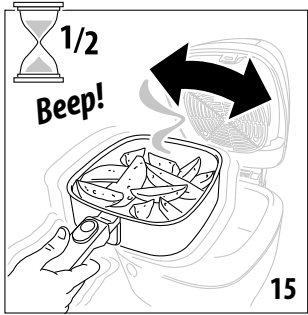
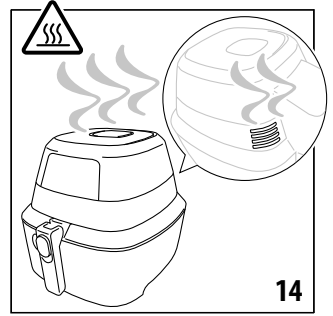
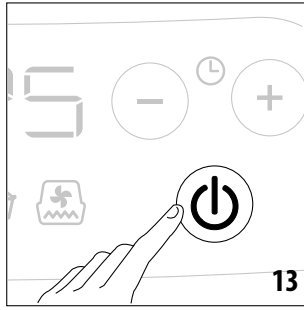
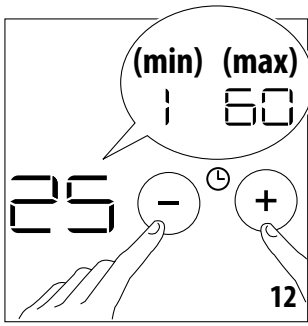

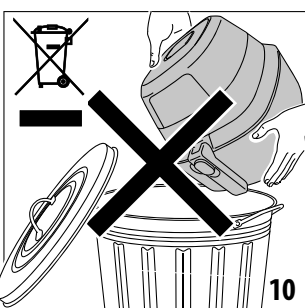
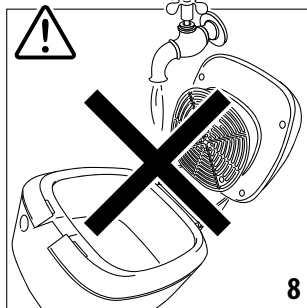
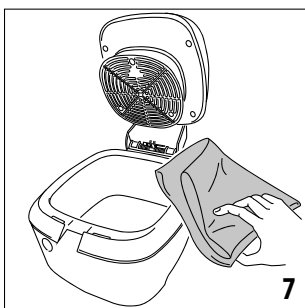
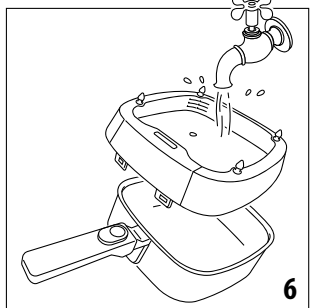
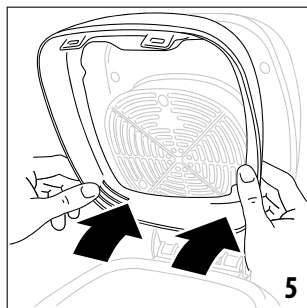
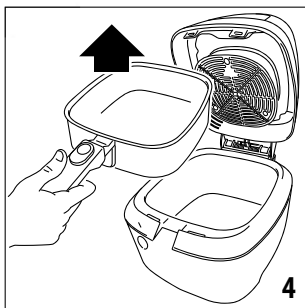
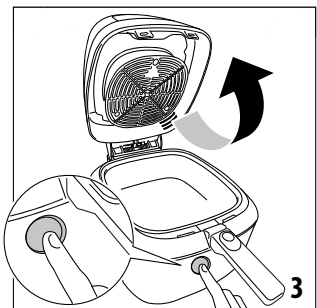
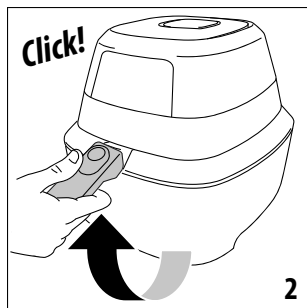
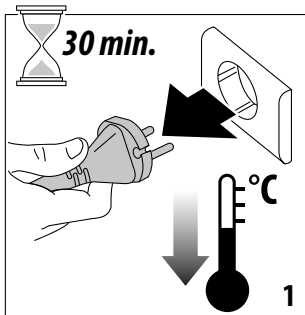

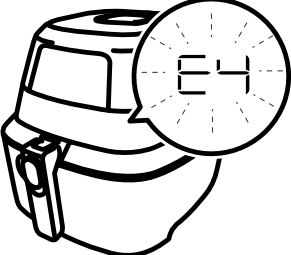



















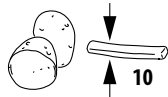
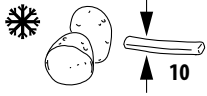
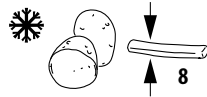













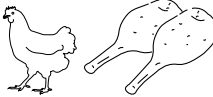









⚠	⏰ 15 min		✓	
 E1 E2 E3 E4 E5 E6 E7 E8 E9	 	 	 	 







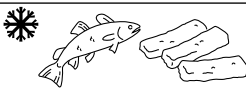

















			 min.					
	FH2184	FH2394						
	-	1.50 (*)	33-36	3	√	√ (beep)	√	1 ½
	1.25 (*)	1.25 (*)	28-30	3	√	√ (beep)	√	1
	1 (*)	1 (*)	23-25	3	√	√ (beep)	√	1
	0.75 (*)	0.75 (*)	20	3	√	√ (beep)	√	½
	-	1.25	29-31	3	√	√ (beep)	√	-
	1	1	25-28	3	√	√ (beep)	-	-
	0.75	0.75	20-22	3	√	√ (beep)	-	-
	0.50	0.50	17	3	√	√ (beep)	-	-
	-	1.25	29-31	3	√	√ (beep)	√	-
	1	1	23-26	3	√	√ (beep)	-	-
	0.75	0.75	18-20	3	√	√ (beep)	-	-
	0.50	0.50	15	3	√	√ (beep)	-	-
	-	1.50 (*)	33-36	4	√	√ (beep)	√	1 ½
	1.25 (*)	1.25 (*)	25-30	4	√	√ (beep)	√	1
	-	1	28-30	4	√	√ (beep)	-	-
	0.75	0.75	22-25	4	√	√ (beep)	-	-
	-	1	23-25	4	√	√ (beep)	-	-
	0.75	0.75	18-20	4	√	√ (beep)	-	-

(\*) da pelare - un-peeled potato weight - à éplucher - ungeschält - te schillen - para pelar - a serem descascadas - για καθάρισμα - следует очистить - hámozandó - k loupání - je potrebné ich očistiť - do obrania - mǎ skrelles - skalad - skal skrællés - kuorittuina - neoguljen - olupiti - за белене - pražiti - kabukları soyulmuş - يجب تقشيرها - سيب زمینی معمولی -

			 min.				
	FH2184	FH2394					
	1	1	40-45	3	√	√	-
	0.50	0.50	16-18	3	√	√	-
	0.40	0.40	10-12	3	√	√	1
	1.2	1.2	42-45	3	√	-	-
	0.6	0.6	20-25	3	√	√	1
	0.45	0.45	8-10	4	√	-	1
	0.6	0.6	15-20	4	√	√	1

			 min.				
	FH2184	FH2394					
	0.4	0.4	18-20	3	√	-	1
	0.7	0.7	20-25	1	√	-	-
	0.45	0.45	8-10	3	√	√	1
	0.25	0.25	8-10	3	√	√	1
	0.15	0.15	8-10	4	√	√	1

			 min.				
	FH2184	FH2394					
	0.75	0.75	30-35	3	√	-	-
	(x4) 0.25	(x4) 0.25	20-25	3	√	-	-
	0.3	0.3	16-18	3	√	-	-
	7-8 pz	7-8 pz	20-25	3	√	-	-
	3-4 pz	3-4 pz	10-12	3	√	√	1

			 min.				
	FH2184	FH2394					
	1	1	10-15	3	√	-	-
	0.8	0.8	40-45	3	√	√	1
	4 pz	4 pz	12-15	3	-	-	-
	4 pz	4 pz	18-20	3	-	-	-