

FOTILE

RANGE HOOD

User Manual | EMS9026

Please read carefully about the user manual before using the product.
And keep it well after reading, for future reference.

Any needs, please contact FOTILE service center.
Some pictures in this manual are sketch map, only
for reference. If there are some discrepancies,
please subject to real object.

WWW.FOTILEGLOBAL.COM

FOTILE America LLC

*Address: 6 Campus Dr, Suite 210, Parsippany, NJ 07054
 *Toll Free: 888-315-0366
 *Website: us.fotileglobal.com
 *Service Mail: serviceusa@fotile.com



FOTILE YouTube



US WeChat Service

FOTILE Toronto Flagship Store

*Address: 8365 Woodbine Ave, Markham, L3R2P4
 *Toll Free: 844-315-0315
 *Website: ca.fotileglobal.com
 *Service Mail: service@fotileca.com



Canada WeChat Official Account



Canada WeChat Service

Dear User, thank you for purchasing the Fotile Range Hood. At Fotile, we manufacture exquisite appliances that are expertly crafted with the finest materials. Before using the Fotile Range Hood, please take some time to read through this Product Manual (manual). It will familiarize you with important safety, operation and maintenance instructions, as well as help maximize your culinary experience.

Before using the Fotile Range Hood, you must follow the instructions, as specified in this manual. Any damage resulting from the improper operation and/or maintenance of the appliance may result in the loss of warranty. The warranty will become invalid, and your warranty application, whether direct or indirect, will not be accepted by authorized service center of Fotile. If you require warranty or post-warranty after-sale service, please contact the local authorized service center of Fotile nearest you.

Your satisfaction with the Fotile brand is important to us. Our after-sales service centers provide assistance in resolving issues with Fotile appliances.

Product model and serial number are required if you need services.

CONTENTS

Warning and Safety Instructions 2

Usage 8

 Main Technical Specifications 8

 Operation Instruction 8

Cleaning and Maintenance 9

Normal Malfunction and Trouble Shooting 11

Installation 12

 Packing List 12

 Installation Guidance 13

 Product Basic Conditions 16

 Installation Suggestions 17

 Installation Steps 18

 Debugging 20

 Component Name Diagram 21

Product features and specifications are subject to change, at any time, without notice and may be different from those in this material. Please visit our website at www.fotileglobal.com for the most up-to-date information.

Warning and Safety Instructions

To ensure the safe and efficient use of your FOTILE product, please note the highlighted information in the product manual as follows:

- * **Warning:** Indicating a risk of serious bodily injury or death if precautions are not observed.
- * **Notice:** Indicating possible minor personal injury or product damage if instructions are not followed.
- * **Important:** Emphasizing information of critical importance.

Safety Instructions

Please be sure to read these safety instructions before using the product.

Please be sure to properly keep these safety instructions.

This product is for indoor use only.

To avoid any accidental risks and damage to the range hood, please read this product manual carefully before the installation and use. Only in this way can you operate this product safely and correctly and reduce the risks of fire, electric shock, personal injury, etc. Please properly keep this product manual for future use or for subsequent users.

Warning

● Risk of Electric Shock

A defective appliance may cause electric shock. Never switch on a defective appliance. Unplug the appliance from the mains or switch off the circuit breaker in the fuse box in case of problems, and contact our authorized service center.

- The range hood should be connected to a standard power socket with safe grounding. Midway connection, prolonged electric line or multi-socket wiring may cause electric shock, overheating and, in some cases, result in a fire. Installation of the range hood should be performed by professional electricians in strict accordance with electricity standards and regulations of the local area. Before connecting the rod, turn off the power source and take appropriate measures to prevent auto closing of the power switch.

- In order to prevent electric shock and/or other bodily injuries to persons, do not exceed 125V AC input.

- Do not install the range hood in a bathroom and/or a humid area, as this will significantly increase the risk of electric shock.

- If a wire is damaged or defective, contact an authorized service provider or a qualified technician (provided by FOTILE) to replace the wire.
- Do not change, stretch, knot, pressure or squeeze the wire as any resulting damage can result in electrical and/or fire hazards.
- Prevent water from coming into contact with the range hood's electrical components, such as the motor, switch and connector. Do not rinse the appliance with water. Do not use the appliance if it is wet, as electric leakage and/ or electric shock may occur.
- Do not attempt to change the range hood's internal wiring system. Improper modifications and/or repairs to the internal wiring can result in bodily injuries to persons, electric shock and/or a fire.
- In order to avoid electric shock, remember to turn off the appliance's power source before installation, cleaning and/or maintenance service.
- Avoid using high-pressure detergents and/or steam cleaners on the appliance, as they may result in electric shock.
- Do not touch the plug or switch with wet hands, as an electric shock may occur.

● Grounding Instructions

- This appliance must be grounded. In the event of an electrical short circuit, grounding reduces the risk of electric shock by providing an escape wire for the electric current. This appliance is equipped with a cord having a grounding wire with a grounding plug. The plug must be plugged into an outlet that is properly installed and grounded.
- The grounding-type attachment plug provided with this appliance shall be connected to a grounding-type receptacle installed in accordance with CSA C22.1, Canadian Electrical Code, Part I.
- Improper grounding can result in electric shock.
- Consult a qualified electrician if the grounding instructions are not completely understood, or if doubt exists as to whether the appliance is properly grounded.
- Do not use an extension cord. If the power supply cord is too short, have a qualified electrician install an outlet near the appliance.

● Risk of Fire

- In order to reduce the risk of fire and to properly exhaust air, we recommend duct the air outside. Do not vent exhaust air into spaces within walls, ceilings, attics, crawl spaces and/ or garages.
- In order to prevent the risk of fire, the range hood should be operated and maintained in accordance to the instructions.
- Hot oils may ignite and burn quickly. Never leave hot oils unattended.
- Clean the hood's oil cup at regular intervals, as leftover grease deposits may ignite.
- Never operate the range hood without the filter.
- Never work with naked flames close to the appliance. Do not install the appliance near a heat-producing appliance for solid fuel (e.g. wood or coal). There must be no flying sparks.

- Avoid cooking with food products that produce flames under the range hood.
- To Reduce Risk of Cooktop Grease Fire:
 1. Never leave the burners work unattended. Overflowing cause smoking and greasy spillovers that may ignite. Heat oils slowly on low or medium settings.
 2. Always turn the hood on during cooking.
 3. Cooking grease may stick on the surface of the kitchen floor, cabinet, vent duct, etc. Better clean regularly to avoid fire risk.
 4. Use proper pan size. Always use cookware appropriate for the size of the pan support.
- To Reduce the Risk of Injury to persons in the event of cooktop fire, observe the following:
 1. Smother flames with lid, cookie sheet, or metal tray, then turn off the burner. Be careful to prevent burns. If the flames do not go out immediately, evacuate and call the fire department.
 2. When the cooking utensil catches fire, switch off the range hood immediately. Effective extinguishing measures must be taken at once, such as covering the open flame with metal cover, turning off the master gas valve and keeping flammable substance from the open flame etc.
 3. Never pick up a flaming pan you may be burned.
 4. Do not use water, including wet dishcloths or towels a violent steam explosion will result.
- Use an Extinguisher Only If:
 1. You know you have a class ABC extinguisher and you already know how to operate it.
 2. The fire is small and contained in the area where it started.
 3. The fire department is being called.
 4. You can fight the fire with your back to an exit.
- Risk of Injury
 - This appliance is not intended for use by persons (including children) with reduced physical, sensory or mental capabilities, or lack of experience and knowledge, unless they have been given supervision or instruction concerning use of the appliance by a person responsible for their safety. Children should be supervised to ensure that they do not play with the appliance.
 - The range hood may have sharp edges. Be careful to avoid cuts and abrasions during installation and cleaning. Do wear qualified protective gloves.
 - The accessible parts become very hot when in operation. Never touch hot parts. Keep children at a safe distance.
 - Do not touch lamps during or soon after operation. Burns may occur.

- Do not insert your limbs and/or foreign objects into the impeller while the range hood is in operation, as that action might cause injury.
- This appliance is not intended for operation with an external clock timer or a remote control.
- Incorrect repairs are dangerous. Repairs may only be carried out and damaged power cables replaced by one of our trained aftersales technicians.
- If any abnormalities and/or defects occur while operating the range hood, immediately turn off the appliance and unplug the appliance from the mains or switch off the circuit breaker in the fuse box. Then, contact our authorized service center. Abnormal operation and defects may cause hazardous situations, such as electric shocks and fires.
- This product contains chemicals known to the State of California to cause cancer, and birth defects or other reproductive harm. For more information, please go to: www.P65Warnings.ca.gov
- Risk of Suffocation
 - Packaging material is dangerous to children. Never allow children to play with packaging material, which may cause suffocation. Keep all packing material out of proximity to children. Please remember that packaging materials should not be treated as toys.
- Risk of Death
 - Risk of poisoning from flue gases that are drawn back in. Always ensure adequate fresh air in the room if the appliance is being operated in exhaust air mode at the same time as room air-dependent heat-producing appliance is being operated. Exhaust gases through the flue (chimney) of fuel burning equipment to prevent back drafting. FOTILE is not responsible for injuries caused by improper and/or incorrect operation of the range hood.

Notice

- When applicable local regulations comprise more restrictive installation and/or certification requirements, the aforementioned requirements will prevail, and installation personnel must conform to these requirements.
- The operating temperature of the range hood should not exceed 104 °F (40°C).
- Please do not place anything on top of the product. Anything placed on top may fall off or incline. For example, if you place seasoning bottles on top, the inclination may cause liquid to flow inside the product, resulting in damaged electrified components and therefore unnecessary risks. Our company will not bear the responsibility for free repair in case of product damage due to the above reason.

- Clean the oil cup frequently to prevent overflow. The resulting grease is inedible! Please do not place flammable materials in the oil cup, such as plastic wrap, paper towels, etc.
- When cutting or drilling into the wall or ceiling, be careful not to damage electrical wiring, water pipes, gas lines, or other hidden utilities.
- Adhere to the heating equipment manufacturer's guidelines and safety standards, such as those published by the National Fire Protection Association (NFPA), the American Society for Heating, Refrigeration and Air Conditioning Engineers (ASHRAE) and the local code authorities. Meanwhile, conform to the safety standards issued by such administrative departments as fire department.
- When gas burners are in operation without any cookware placed on them, they can build up a lot of heat. A ventilation appliance installed above the cooker may become damaged or catch fire. Only operate the gas burners with cookware on them.
- Adhere to the voltage and frequency settings listed in this manual to avoid possible damages to the range hood.
- Please use standard accessories provided by our company to prevent the range hood from falling down accidentally. The hole drilled in the wall should precisely match the size of the expansion pipe, otherwise, the range hood may loose and fall down.
- Tempered glass is applied to the products of the company and the tempering treatment of the glass determines the extremely little possibility of spontaneous explosion. If the occurrence of spontaneous explosion is not due to improper use, our company promises free replacement of the accessories. The possibility of tempered glass breaking can be significantly increased in the following situations, which should be avoided: For instance, hitting the glass, especially the corners of the glass, with cooking utensils or other hard objects; The glass is impacted when you open a cabinet door around the Range Hood; Put the glass in an extremely hot or cold environment or an environment where heat and cold are excessively alternated.
- Unauthorized modification of this product can lead to risks.

Important

- This appliance is intended for indoor home cooking only; it cannot be used for outdoor cooking. Please use this product only according to the manufacturer's instructions. FOTILE assumes no responsibility if you use it in special environment. Please contact a FOTILE authorized service center if you encounter any problem.
- Check the appliance for damage after unpacking it. If you detect any obvious damage to the product, do not proceed with the installation. Please contact our authorized service center immediately.

- Avoid placing gypsum powder, construction dust, etc. within close proximity of the range hood.
- Operate the range hood only in the manner outlined in this product manual. When operating the range hood, do not leave the appliance unattended. If you have any questions and/or concerns, please contact our authorized service center.
- Operate, clean and maintain the range hood in accordance to the instructions outlined in this manual.
- Clean the metal grease filter according to the instructions.
- The range hood's motor has a thermal overload function, which automatically turns off the motor when it overheats. Once the motor cools down, the range hood will automatically restart. If the motor, continually turns off and restarts, please contact our authorized service center.
- If the range hood has not been in operation for an extended period of time, unplug the appliance.
- Please make sure correct installation and maintenance of the appliance. Installation work and electrical wiring must be done by qualified person(s), in accordance with all applicable codes and standards, including fire-rated construction codes and standards. The installation personnel should be responsible for normal operation of the appliance at the installed position.
- Please install the damper according to the national or local codes if you need.
- For general exhausting only. Do not use this range hood to exhaust hazardous and /or explosive materials or gas.
- The product itself is nonflammable.
- In order to reduce the risk of fire, all exhaust pipes, flues and devices should be nonflammable. Use only metal duct cover and metal duct pipes. Never cover the hood with flammable plastic film or paper.
- Services guaranteed under warranty must be performed by FOTILE certified service provider or personnel. The warranty is not effective for products removed for repair without authorization.
- Please read the specification label on the range hood for further information and requirements.
- Please install a supplementary air device if you install the high-power Range Hood in an airtight room. Due to the configuration of the FOTILE Range Hood, it is recommended for users with an airtight new house to install a supplementary air device. Please comply with relevant regulations to install corresponding supplementary air device if there are relevant regulations in your state or region.
- This product is for use in the U.S. and Canada only.

Usage

Main Technical Specifications

| | | | |
|---|--------|----------------------|-----------------|
| Model | | EMS9026 | |
| Certification | | ETL | |
| Product Size | Width | 35 5/16inches(896mm) | |
| | Depth | 20 5/16inches(515mm) | |
| | Height | 25 1/4inches(640mm) | |
| Voltage/Frequency | | 120V/60Hz | |
| Input Power | | 310W | |
| LED Lights | | 2W | |
| Speed | Low | High | Auto Turbo Mode |
| Air volume(m³/h) | 600 | 770 | 1030※ |
| Noise(dB(A)) | 43 | 48 | 54 |
| Max static pressure(Pa) | 350 | 420 | 500 |
| <p>a.1030※: When the exhaust resistance if the product is greater than the set resistance, the maximum air volume in automatic cruise pressurized mode can be up to 1030m³/h.</p> <p>b.Noise in the above table complies with the IEC 60704-3-2006 standard, it is the sound pressure level. The corresponding sound power level is: 68 dB(A) for auto turbo mode, 62 dB(A) for high and 57 dB(A) for low.</p> <p>c.The air volume in the table are tested in accordance with IEC 61591-2010 standard.</p> <p>d.Such parameters as air volume and noise may have a deviation of less than 5%.</p> | | | |

Operation Instruction

■ Operation Interfaces Instructions

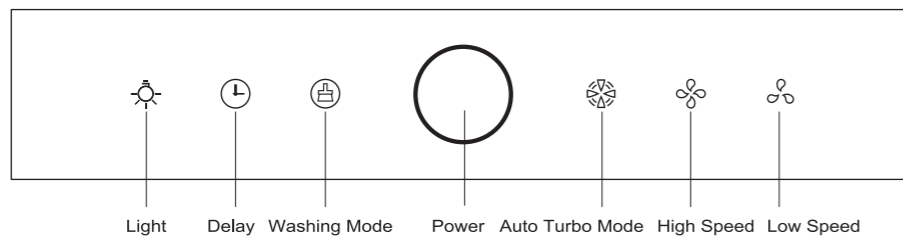

■ Commissioning and Functions

- Power**
Press ○ once in the shutdown state to enable the standby state and it will shut down automatically with no operation of other key in 2min.
In the working / standby state, press ○ to shut down the kitchen ventilator.
The following keys are available when the power is on.
- ☀ Light**
Press ☀ once to turn on the light and press ☀ again to turn off the light.

- ⌚ Delay**
In the standby or running state, press ⌚ to enable the delay shutdown with all functions turned off after 2min. Press any key to cancel the delay.
- ☹ Washing Mode**
 - Press ☹ to turn on the light and lower the wing-shaped surround suction plate to the lowest position for cleaning and maintenance, and press ☹ again to lift the plate to the top position.
 - Washing Mode and ☀.☀.☀.⌚ are mutually exclusive. When one of the above four functions is enabled, press Washing Mode to exit the corresponding functioning pattern. ☀.☀.☀.⌚ are unavailable in cleaning and maintenance state.
 - Press ○ in the cleaning and maintenance state and the wing-shaped surround suction plate will immediately rise to the top position.
- ☀ Auto Turbo Mode**
In the standby or running state, press ☀ to turn on all lights and kitchen ventilator enters Auto Turbo Mode to automatically detect the flue resistance. When flue resistance exceeds the set value, exhaust fan automatically switches to Booster Mode, and switches back to Normal Mode 30s after the flue resistance reduces to normal. Press ☀ to disable the function.
- ☀ High Speed**
Press the key to start the exhaust fan and turn on the ☀ light, the kitchen ventilator will run at High Speed mode, and press again to turn off the fan.
- ☀ Low Speed**
Press the key to start the exhaust fan and turn on ☀ light, the kitchen ventilator will run at Low Speed mode, press again to turn off the fan.

Cleaning and Maintenance

| | | | |
|--|---|--|--|
| | 1. Cut off the power before cleaning. | | 2. All electric parts, include motor, switch, etc. should be away from water. |
| | 3. Please don't clean the surface with rough material like steel wire ball, brush or coarse cloth, etc. It will greatly scratch the surface. | | 4. Please don't clean with gasoline, acidic substance, benzene, solvent and other chemical agents. If you need to clean, please use neutral cleanser, and wipe dry the appliance surface by soft cloth after cleaning. |
| | 5. If the stainless steel panel is stained with salty liquor, disinfectant, bleaching powder and other cleanser, please wipe it by wet cloth at once and dry it by dry cloth. | | 6. Hold up both ends of the oil cup with both hands, maintain it horizontal, slowly shift out from the front of the extractor hood, take down the cup, and pour accumulated oil. |

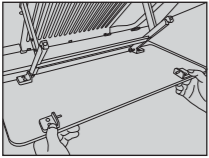
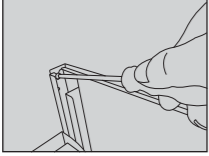
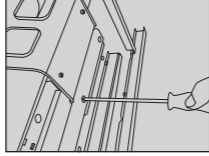
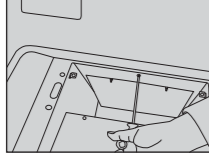
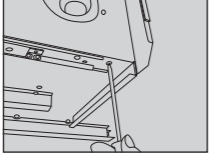
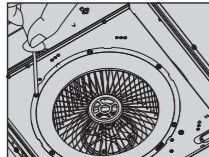
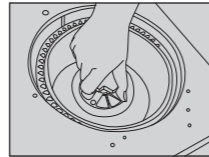
7. Firstly, press down the unpacking and washing key to descend the butterfly wing plate to the lowest position, grasp the front edge of the plate with both hands, turn over downward, make the plate buckle to divorce, turn over a certain angle downward and take down the butterfly wing plate. Secondly, move the buckle of the outside screen and take down the outside screen. Thirdly, hold up the inside screen with the left hand, use the cross screwdriver to open with the right hand the two screws used to fix the inside screen, and take down the inside screen.

8. Use the cross screwdriver to open the two screws used to fix the fan outer cover, and take down the fan outer cover and the trim cover.

9. Use the cross screwdriver to open the screws of the connecting rod (two on both sides respectively, and disassemble the lifting poker;

10. Use the cross screwdriver to open the five screws in the fan frame (one on both sides respectively; three on the top, open the four screws on both sides, open the screw on the fan cover, and disassemble the fan cover plate.

11. Use the cross screwdriver to open the screws on the air inlet ring.

12. Screw down the locknuts clockwise, and take down the impeller.

- a. Please cut off the power first before cleaning and replacing components so as not to get an electric shock.
- b. Please wipe surface of range hood (surface of air inlet net and back of smoke baffle shield) and close smoke baffle shield after using range hood every time.
- c. Use type lamp is self-ballasted fluorescent reflector lamp - Integral induction type ballast.
 1. Max wattage: 2W
 2. Voltage range: 9~10V
 3. Dimensions: width 7 7/8"(199.3mm)/depth 1"(24mm)/height 2"(49.4mm)











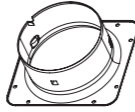
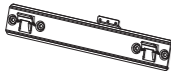



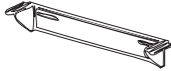

Normal Malfunction and Trouble Shooting

| Malfunctions | Possible reasons | How to check |
|--|---|--|
| Range hood can't work, light can't lighten | Haven't connected with power supply | Check whether the plug is well inserted or not |
| | | Check whether there is electricity or not in the plug |
| Motor can working, but light can't lighten | LED light is damaged | Replace LED light (done by professional people) |
| There is machinery shaking noise | Screw is loosed | check whether the surface screws are tightened or not |
| Suction power is weak | Too long distance between range hood and stove | Lower the range hood installation height (done by professional people) |
| | Too much ventilation near the range hood leads to strong convection | Close some doors and windows |

- a. Change the LED light: please contact FOTILE after-sale service center.
- b. If the range hood still can't work after getting rid of the above malfunctions, please contact FOTILE service center.
- c. The following information is required for the warranty period:
 1. Date of purchase
 2. Product model
 3. Serial number
 4. Relevant vouchers for purchase
- d. The ventilator shall be not allowed to be repaired by any party other than Fotile's appointed technicians. Otherwise it may cause serious consequences and exempt the product from warranty.
- e. The following circumstances do not fall into the scope of free warranty, and a fee will be charged for repair.
 1. Damage resulting from improper handling, installation, use, maintenance and safekeeping conduct-ed by customer.
 2. Failure and damage caused by using the product beyond the normal operating conditions (damage caused in the case that the voltage is higher than 132V or lower than 103.2V).
 3. The product installed, dismantled or repaired by customer or any party other than Fotile's appointed service staff or agency.
 4. Discrepancy between the information on the purchase voucher and the warranty card and the product.
 5. Product damage caused by force majeure (such as natural disaster and war, etc.).
 6. Product failure or damage arising from use not in conformity with the "instructions".

Installation

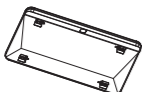
Packing List

| Standard Configuration | | Standard Configuration | |
|--|---|--|---|
| Product  | 1 | Metal Outlet Housing  | 1 |
| Hook  | 1 | Outer Net  | 1 |
| Decorative Cover  | 1 | Expansion Tubes for Tiles Φ1/4"×1 5/16"(Φ5.3×32mm)  | 6 |
| Oil Cup  | 1 | Expansion Tubes for Plasterboards Φ3/16"×1 5/8"(Φ4×40mm)  | 6 |
| Decorative Cover Hook  | 1 | Hook Screw #8×1 7/16"(ST4.2×36mm)  | 6 |
| Metal Sealing Gasket  | 1 | Wood Screws #10×2 9/16"(ST5×65mm)  | 4 |
| Operation Manual  | 1 | Cruciform-slot Pan-head Thread-forming Screw #8×1/ 2"(M4×12mm)  | 8 |
| Warranty Card  | 1 | Cruciform-slot Pan-head Thread-forming Screw #4×3/4"(ST2.9×19mm)Zinc Coating  | 2 |
| Wing-like Plate Subassembly  | 1 | Cruciform-slot Large-brazier-head Thread-forming Screw #8×3/8"(M4×8mm) Zinc Coating  | 2 |
| Anti-collision Components  | 2 | | |

Installation Guidance

To ensure the safe and efficient use of your FOTILE product, please note the highlighted information in the product manual as follows:



- * **Warning:** Indicating a risk of serious bodily injury or death if precautions are not observed.
- * **Notice:** Indicating possible minor personal injury or product damage if instructions are not followed.
- * **Important:** Emphasizing information of critical importance.

 Safety Instructions

Please be sure to read these safety instructions before using the product.

Please be sure to properly keep these safety instructions.

This product is for indoor use only.

Warning  

- In order to reduce the risk of fire, electric shock, or injury to persons, please carefully read the following:
 - The installation and wiring of the appliance should only be carried out by a professional electrician in accordance with current national or local electric safety regulations, including fire-rated construction. Non-professional personnel should not conduct installation. Proper installation is the responsibility of the installer. Product failure due to improper installation is not covered under the FOTILE warranty.
 - Please use standard installation equipment and tools provided by FOTILE to ensure safe installation. Make sure to use the expansion tube and expansion bolt provided by our company, in case the range hood falls down accidentally. The hole drilled into the wall should precisely match the size of the expansion tube, otherwise the range hood will not be properly secured to the wall and may fall down.
 - The range hood should be connected to a standard power socket with safe grounding. The midway connection, prolonged electric line or multi-socket wiring may cause electric shock, overheating and even fire. Power off before wiring and make sure proper measures have been taken to avoid unexpected connection.

- During the installation, switch off the circuit breaker in the fuse box during installation. If the supply cord is damaged, it must be replaced by a special cord or assembly available from the manufacturer or its service agent.

- The appliance should only be installed, removed and maintained by qualified technicians to prevent risks like electric shocks, falling or fires from occurring.

- Risk of Injury:

- Unplug the appliance from the mains or switch off the circuit breaker in the fuse box before installation, cleaning, maintenance and repair in order to avoid electric shock.

- The range hood may have sharp edges. Be careful to avoid cuts and abrasions during installation and cleaning. Do wear qualified protective gloves.

- Warning Before Installation

- Prior to installation, ensure that the exhaust outlet is free of debris, as they may damage the range hood.

- A straight and short ducting run will ensure high performance of the range hood.

- A curving and long ducting run should be avoided, as it will lower the performance of the range hood.

- Strictly seal the connection between the duct and duct hole with duct tape. Ensure that the connection between the duct and the duct cover is secure, and seal it with aluminum tape.

- A small duct hole will lower the performance of the range hood. Therefore, it is highly recommended that your duct hole equal to or larger than 6"(150mm) of the size.

- The bolts used in this product are metric-size bolts, please do not apply any unqualified bolts.

Notice

- Please carefully read all instructions prior to installation. Please give special consideration to the following items:

- If you are renovating your kitchen, be careful to not expose the exterior of the range hood. Building materials, dust, paint, coating, and gases will corrode and tarnish the surface of the range hood. It is recommended that you install the range hood after all renovations are completed.

- If you need to remove your gas burner before installation, please turn off the main gas valve first.

- Do not connect the range hood duct to a duct used to exhaust hot air or fumes from another appliance.

- Two installers are recommended due to the large size and heavy weight of the range hood. Since the installation is complex and the appliance is heavy, professional installers are required to install the appliance as outlined in this manual.

- After the appliance fixed, the plug should be accessible.

- Make sure to keep the appliance horizontally.

- Ensure that the appliance functions normally after the installation is complete.

Important

- Prior to installation, please read the FOTILE Range Hood Installation carefully and save it for the local inspector's future reference.

- This appliance must be installed in accordance with National Electrical Codes, as well as all state, municipal and local codes.

- The appliance must be equipped with safe circuit breaker and installed with safe grounding.

- The correct voltage, frequency and amperage must be supplied to the appliance according to the proper voltage, frequency and amperage ratings listed on the product rating plate.

- This installation must be completed by FOTILE authorized service center, or certified installers.

- Please record the model and serial number before installing the range hood. Position of plaque can be referred to in figure A as follows:

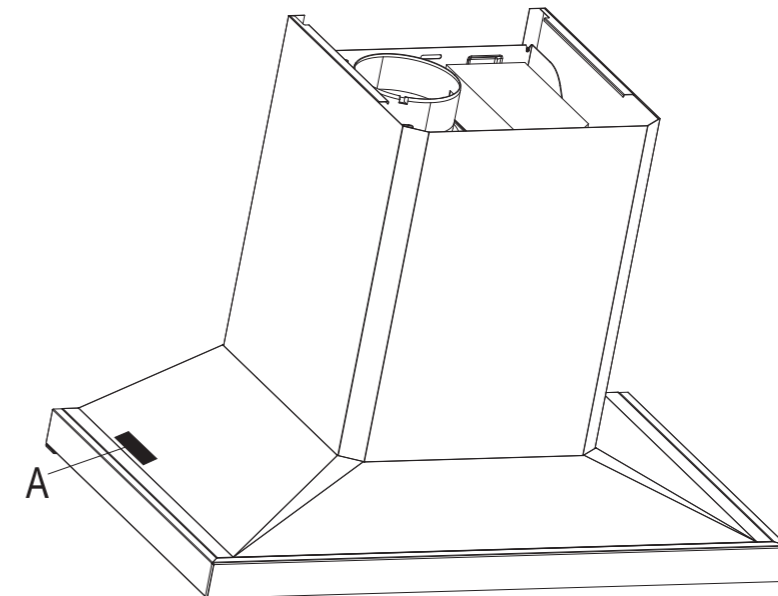

Product Basic Conditions

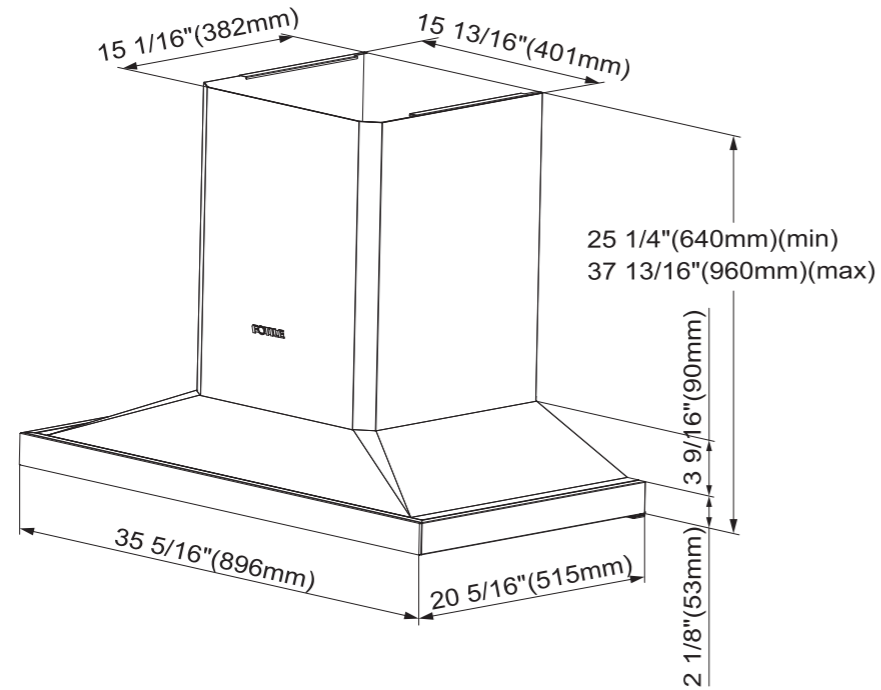

Product Basic Conditions

Installation Suggestions

Installation Diagram of Hoods

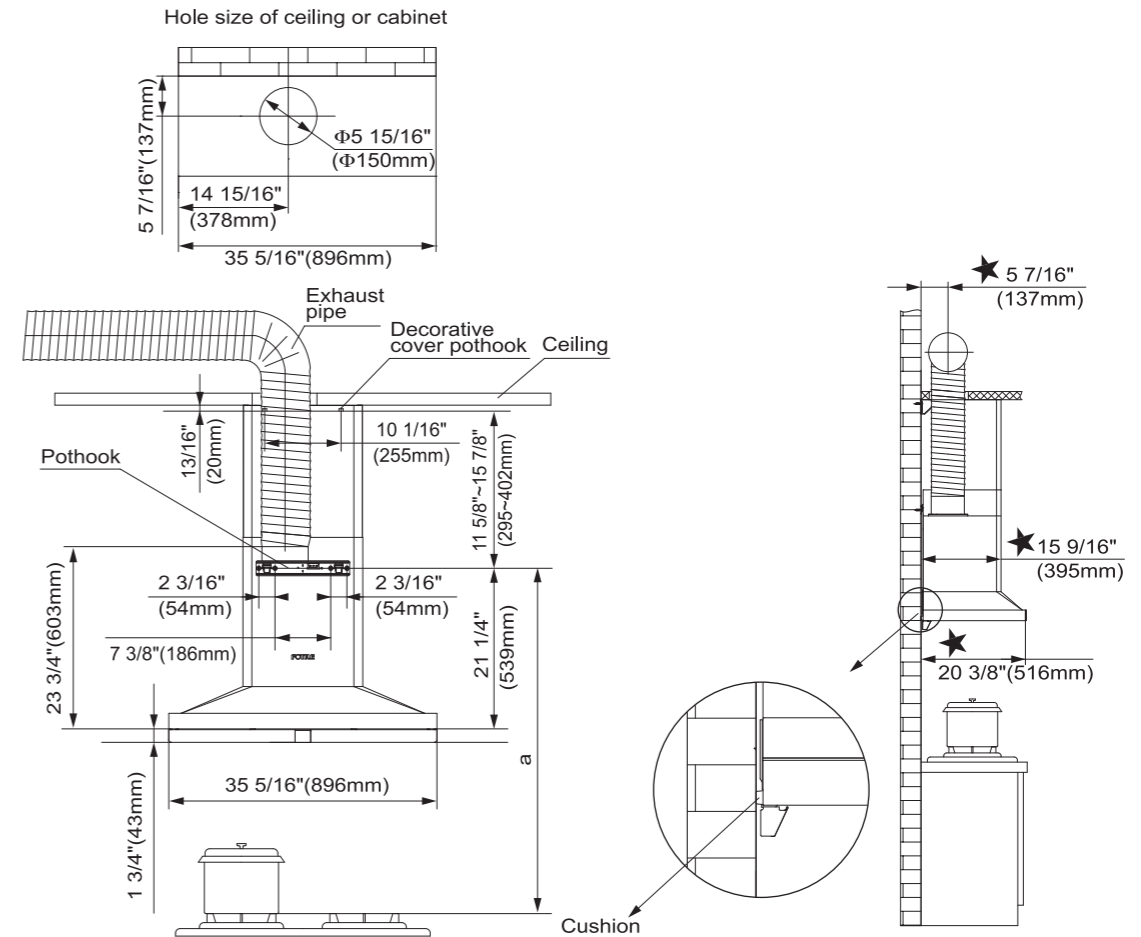

Product installation and cabinet collocation figure diagram
 (★ is the distance from the wall)
 a=46 15/16"~48 9/16"(1192mm~1232mm)(in USA)
 a=48 9/16"~50 1/2"(1232mm~1282mm)(in Canada)



The installation height of the range hood (i.e. the distance between the supporting surface of the cooking appliance on the range and the lowest part of the range hood) is 24 1/16"~25 5/8"(610mm~650mm)(in USA)/25 5/8"~27 9/16"(650mm~700mm)(in Canada). The installation height is the recommended value, and the cupboard and the range hood shown in the figure is for reference only. When the installation height of this product (i.e. the distance between the supporting surface of the cooking appliance on the range and the lowest part of the range hood) is lower than 24 1/16"(610mm)(in USA)/25 5/8"(650mm)(in Canada), all parts below 24 1/16"(610mm)(in USA)/25 5/8"(650mm)(in Canada) are non-flammable parts of the range hood or parts working under safe and ultra-low voltage, and the deformation of these parts will not affect the protection against the touch of live parts. (If relevant laws in the region stipulate the installation height of range hood, it is recommended to abide by relevant laws, but the oil smoke suction effect of the product may be affected to some extent.)

Preparation before installation

- Warning: Please don't make sundries into exhaust pipe to avoid damaging the range hood. Estimate the exhaust pipe position. A straight and short exhaust pipe makes smoke extraction more smooth, please refer to installation diagram. The joint between exhaust pipe and wall hole should be sealed with tape, and ensure firm connection between exhaust pipe and exhaust cover. Too small wall hole will affect smoke extraction, therefore, please broaden the wall hole to fit exhaust pipe size under safety condition.

2.Tool preparation

Please prepare the following tools before range hood installation (include but not limited to the following tools).

- | | |
|--|-----------------------|
| (1) Impact electric drill (with drillbit of $\Phi 10\text{mm}$) | (2) Cross screwdriver |
| (3) Measuring taper | (4) Gradienter |

Installation Steps

- Reserve $\Phi 10\text{mm}$ drill bit for the impact electric drill.
- Refer to installation diagram, set the right position on the wall to drill and then firmly imbed the expansion pipe. Insert $\#10 \times 2 \frac{9}{16}$ " (ST5 \times 65mm) wooden screws to tighten the fixed pothook and decorative cover pothook; then use two $\#4 \times \frac{3}{4}$ " (ST2.9 \times 19mm) Screws to fix the decorative cover on the suspended ceiling (see Fig 1 and Fig 2).
- Refer to Fig 3, use eight $\#8 \times \frac{1}{2}$ " (M4 \times 12mm) Duct Cover Screws to fix the exhaust cover and upper seal mat on the top of complete appliance.
- Fix the exhaust pipe on the exhaust cover and seal with aluminum foil tape.
- Hang the hood firmly: face squarely-not slanting, side-looking-the hood will tightly stick the wall and a little lacune.
- Install the exhaust pipe according to installation diagram: check the pipe shell is not bulging and not shriveled, curve freely. The exhaust pipe and wall should be tightly connected to prevent smoke back, the backflow barrier blade should be up and down smoothly.
- Installation of ring suction plate
 - Hold the front side of the ring suction plate firmly with both hands, and place the left and right pothooks on the rear side of ring suction plate into the left and right hook racks of the smoke collecting hood.
 - Prop the ring suction plate with both hands, make it spiral upward, push in while the ring suction plate spirals, finally make the touch claw on the ring suction plate insert into the touch button on the smoke collection hood.

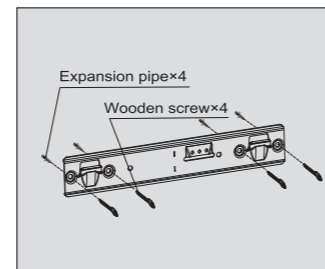

Figure 1

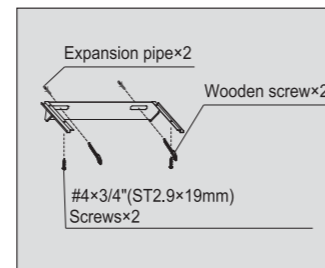

Figure 2

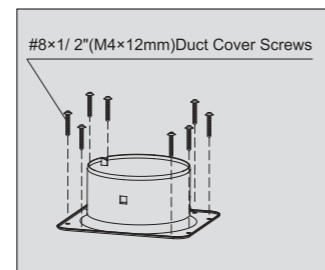

Figure 3

- Insert the host power plug into the power outlet.
- Blower outer cover and decorative cover installation (see Fig 4)
 - Put the decorative cover inside of the blower outer cover.
 - Take up the blower outer cover and decorative cover meantime; inject the decorative cover into decorative cover pothook, then push the decorative cover and blower outer cover along the decorative cover pothook assembly to the end.
 - After pushing the decorative cover and blower outer cover to the end, the blower outer cover will slip down slowly, and inject the blower outer cover buckle to the blower rack, then insert the blower outer cover to the gap which is between top panel and blower rack.
- Install anti-collision accessories, firstly determine the magnetic face of anti-collision component (see Fig 5), then stick the anti-collision accessories to the corner of the smoke exhaust (see Fig 6).
- Install the oil cup (see Fig 7).

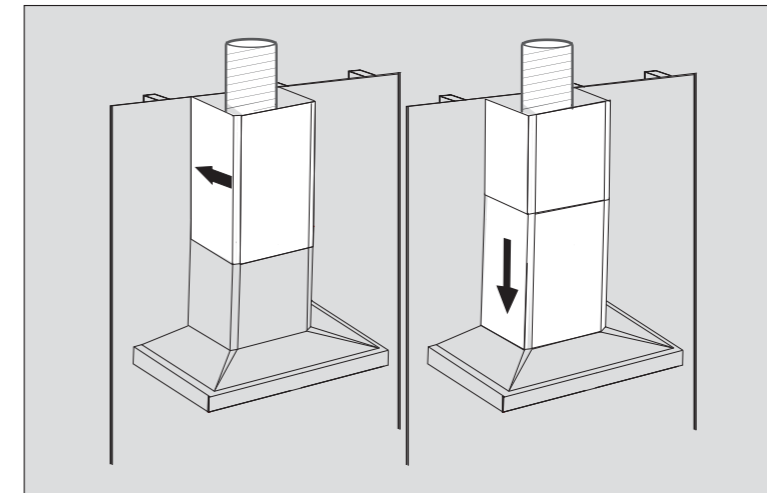

Figure 4

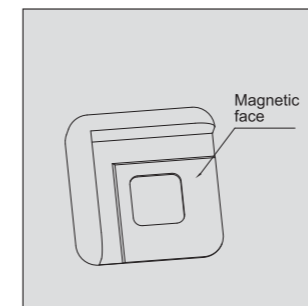

Figure 5

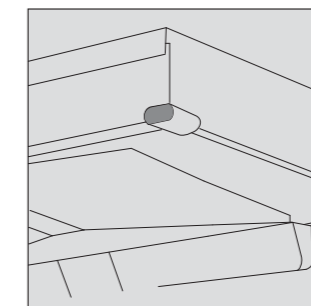

Figure 6

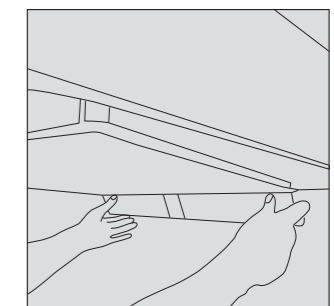

Figure 7

Debugging

1. Put on oil cup.
2. Plug the power cable into socket.
3. Press power key, check whether smoke baffle turns up. Press light key, check whether light works normally.
4. Press High/Low speed or Auto Turbo Mode key, check whether motor turns normally. In the following cases, cut off power, stop turning and check whether it is reason of installation (if range hood breaks down, please contact our service center).
 - (1) Machine shakes violently
 - (2) Expansion pipe looses
 - (3) Impeller doesn't turn
 - (4) Impeller with obvious grating when turning
 - (5) Motor with abnormal noise
5. Press power key, motor stops turning, smoke baffle closes.
 - (1) If the power supply wire is damaged, in consideration of the safety, must have the manufacturer, the repair department or similarly qualified personnel to replace.
 - (2) When the range hood, gas stove or other fuel stove used at the same time, the room must be well ventilated.

Correct Disposal of this product



This marking indicates that this product should not be disposed with other household wastes. To prevent possible harm to the environment or human health from uncontrolled waste disposal, recycle it responsibly to promote the sustainable reuse of material resources. To return your used device, please use the return and collection systems or contact the retailer where the product was purchased. They can take this product for environmental safe recycling.

Component Name Diagram

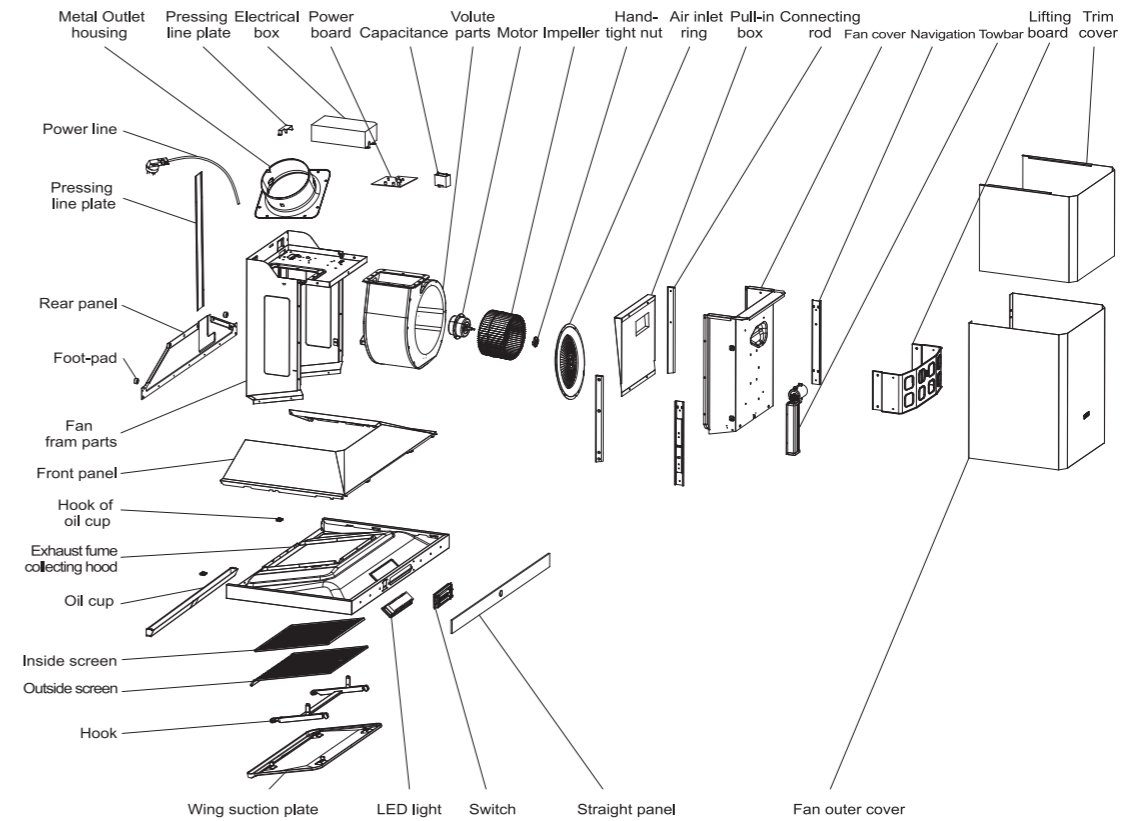

FOTILE

吸油烟机

使用安装说明书 | EMS9026

如有任何需要，请联系方太授权的服务中心。本说明书部分图片为示意图，仅供参考，若图片与实物不符，以实物为准。

WWW.FOTILEGLOBAL.COM

请在开始安装和使用前仔细阅读此产品说明书。
请保留此产品说明书，以供今后使用或后续用户使用。

方太美国分公司

*地址：6 Campus Dr, Suite 210, Parsippany, NJ 07054
 *电话：888-315-0366
 *官网：us.fotileglobal.com
 *服务邮箱：serviceusa@fotile.com



FOTILE YouTube



美国微信客服

方太加拿大旗舰店

*地址：8365 Woodbine Ave, Markham, L3R2P4
 *电话：844-315-0315
 *官网：ca.fotileglobal.com
 *服务邮箱：service@fotileca.com



加拿大微信公众号



加拿大微信客服

尊敬的用户，您好！感谢您选购方太公司为您精心制造的方太系列产品，使用前请通读本《使用安装说明书》（以下简称说明书），此说明书将有利于您熟悉油烟机安全信息、操作和保养维修等，并让您享受到全新的下厨乐趣。

请您在使用前务必认真阅读说明书，并遵从说明书要求进行使用。本说明书的操作说明对于维持产品的良好工作状态十分重要，若因使用不当造成产品故障，您将失去免费保修的权利，任何直接或间接的免费保修申请将不被本公司各地授权的服务中心所接受。同时我们建议您在质量保修期内及保修期后，如有需要维修时请与方太公司当地授权的服务中心联系，这对您和我们都是非常重要的。

我们授权的服务中心将为您提供方太公司专业的零部件及技术支持，使您的产品得到优质快捷的维修保障，同时让您得到最轻松细心的服务。

如果您需要服务，您将需要提供产品型号和序列号。

目录

| | |
|------------|----|
| 警告和安全说明 | 26 |
| 使用方法 | 30 |
| 主要技术参数 | 30 |
| 使用说明 | 31 |
| 清洁保养 | 32 |
| 常见故障的识别和处理 | 33 |
| 安装 | 34 |
| 装箱单 | 34 |
| 安装警告 | 35 |
| 产品尺寸图 | 37 |
| 安装建议 | 38 |
| 安装步骤 | 39 |
| 安装后的调试 | 41 |
| 爆炸图 | 42 |

产品特征和参数会在无通知情况下随时更改，并且可能与此说明书略有不同。请访问我们的官网www.fotileglobal.com，获取最新信息。

警告和安全说明

为确保方太产品的安全和高效使用，请注意产品说明书中以下突出显示信息：

***警告**：标明如不遵守预防措施则可能导致严重人身伤害或死亡等危险。

***注意**：表示如不遵守指导说明则可能出现轻微人身伤害或产品损坏。

***重要**：强调非常重要的信息。

安全须知

请确保在使用产品前阅读此安全须知

请务必保留此安全须知信息

本产品仅限室内家用

为避免任何对油烟机的意外风险和损害，请在开始安装和使用前仔细阅读此产品说明书。只有这样您才能安全正确地操作此产品，降低火灾、电击或者人身伤害等风险。请保留此产品说明书，以供今后使用或后续用户使用。

警告

● 触电危险：

有缺陷的产品可能引起电击，绝不启动有缺陷的产品。如发现问题请将此产品从电源上拔下或切断总电源，并请联系方太授权的服务中心。

■ 此产品应使用专用电源插座，并且专用电源插座应有可靠接地，因为电源线中途连接、使用延长线以及多口配线器时易发生触电、插头插座发热以及火灾。请确保由专业电工在严格按照所在国家和地方的电力法规进行操作，接线以前，请先关闭电源并采取合理措施防止电源开关自动闭合。

■ 禁止使用 125V 以上的交流电，以免引起危险。

■ 禁止将此产品安装在浴室或湿度高的场所，这样容易造成触电。

■ 如果电源线损坏，请联系授权服务提供商或合格技术人员进行更换。

■ 请不要对电源线进行改制、拉伸结扣以及施加重物、挤压等，否则易导致电源线破损而发生触电和火灾。

■ 严禁电机、开关、接插件等电器部件沾水，禁止用水冲洗油烟机。油烟机被水淋湿后，请不要使用，如果使用会导致漏电、触电。

■ 禁止私自改动产品内部布线，否则有可能发生异常动作导致人体受伤。不当修理可能发生触电、火灾等危险。

■ 在清洗产品、提供安装或维修服务之前，必须切断电源，以免触电。

■ 请不要使用任何可能导致电击的高压清洁剂或蒸汽清洗器。

■ 请不要用潮湿的手触摸电源插头电器部件以及操作电源开关，否则易发生触电。

● 接地说明

■ 此产品必须接地。如果发生短路，接地可以降低电击的危险。此产品配有接地插头的电源线。插头必须插在合理安装并接地的电源插座上。

■ 本产品电源线插头应插到按照《CSA C22.1, Canadian Electrical Code, Part I.》这一标准规范的电源插座上。

■ 不合理接地会导致电击危险。

■ 如并未完全理解接地说明或者对产品是否已合理接地存在疑虑，请咨询合格电工。

■ 请不要使用延长线。如果电源线过短，请合格电工在产品附近安装电源插座。

● 火灾危险

■ 为降低火灾危险并合理排气，请优先外排。请不要将废气排到墙体、天花板、阁楼、窄小空间或车库中。

■ 如果不按本说明书规定的方法清洗，油烟机有起火的危险。

■ 热油和油脂会快速点燃，绝不让热油或油脂处于无人看管状态。

■ 油网中油脂沉淀物可能着火，请定期清洗油网。

■ 请勿在无油网的情况下操作此产品。

■ 油网中的油脂沉淀物可能着火，绝不在此产品附近使用明火。请不要在使用固体燃料（比如木头或煤）的加热设备附近安装此产品。禁止有飘飞的火花。

■ 请避免在烟机下方使用会产生火焰的食品。

■ 为降低灶台油火风险：

1. 绝不使灶台表面的器具在无人看管下高档位运行。溢锅造成冒烟和可能起火的油脂外溢，请在低档或中档设置下缓慢加热油脂。

2. 烹饪时请总是开启烟机。

3. 烹饪产生的油脂可能分布在环境中，如地面、橱柜、油烟机表面和排烟管路等，请定期清洁降低起火风险。

4. 请使用合适尺寸的锅具。请总是使用与灶台表面的器具尺寸吻合的炊具。

■ 为降低灶烤一体机上方油火对人身伤害的危险，请遵守以下说明：

1. 用合身的锅盖、烤板或金属托盘扑灭火焰，然后关闭灶具。注意谨防烫伤。如果火焰未立即熄灭，请疏散并报火警。

2. 油锅着火时，请立即关闭油烟机（油烟机的运行会助燃火势）。立即采用有效的灭火措施，如用金属封盖盖住明火、关闭燃气总阀、使易燃物远离明火等。

3. 绝不拿起着火的锅具，您可能被烫伤。

4. 请勿用水，包括湿抹布或毛巾灭火，这样会导致猛烈的蒸汽喷发。

■ 仅在以下条件使用灭火器：

1. 当您上过基础的灭火器课程，并且已经知道如何操作；

2. 当火较小并且控制在火源处；

3. 当您已打火警电话；

4. 当您背向出口时可救火。

● 人身伤害危险

- 此产品不适用于（包括儿童在内）身体、感知或精神能力减弱或缺乏经验或知识的人群，除非在对其安全负责的人监督或指导如何安全使用此产品的情况下。孩童应受监管，确保其不玩弄此产品。
- 油烟机可能有非常锋利的边，在进行安装、清洁或修理时，谨防被油烟机内金属板快口等划伤和擦伤。应佩戴合格的防护手套。
- 操作中可触及部分会变得很烫。绝不触摸变烫的部分。保持儿童在安全距离以外。
- 请勿触摸已经开启或刚关闭不久的灯，以免烫伤。
- 油烟机叶轮运转时，禁止将手指或其他物品放入其中，以免造成伤害。
- 此产品不应和外部钟表计时器或遥控器配合使用。
- 不正确的维修很危险。仅合格的售后服务技师才可进行维修。
- 出现异常现象时，请关闭产品电源，拨下电源插头或者切断总电源，马上与方太授权的服务中心联系。异常状态下连续运转易发生触电、火灾等危险。
- 本产品可能会使您暴露于化学物质，加利福尼亚州已知该化学物质可致癌和出生缺陷或其他生殖危害。如需了解更多信息，请访问：www.P65Warnings.ca.gov

● 窒息危险：

- 包装材料对儿童有危险。绝不允许儿童玩弄包装材料，这可能会产生窒息事故，所以请让包装材料远离儿童，包装材料不是玩具。

● 死亡危险：

- 烟道倒灌有中毒危险。当此产品在排气模式下运行，同时依赖于房内空气的加热设备也在运行时，请总是确保屋内有充足空气保证充足燃烧和排气。请通过烟道（烟囱）排放废气，防止废气倒灌。因使用不当或误操作造成的伤害厂商不负责任。

注意 

- 若当地适用的法规包含更为严格的安装和认证要求，上述要求优先于此文档中相应的要求，并且安装人员同意遵守这些要求。
- 油烟机使用环境的温度不能超过104°F（40°C）。
- 请不要在此产品上放置任何物品，产品上放置的东西可能跌落或倾倒。例如把调料瓶放置在油烟机顶部，倾倒后可能造成液体流入产品内部，导致带电部件损坏，造成不必要风险。若因此造成的产品损坏，本公司不承担免费保修责任。
- 请及时清理油杯中的废油，防止溢出。油杯中所收集的废油请勿食用！请不要在油杯中放置易燃物，如保鲜膜、厨房纸等。
- 当在墙上或天花板上开凿或钻孔时，请注意不要损坏电线、水管、燃气管道以及其他隐藏的设备。

- 请遵照加热设备厂商的指导方针和安全标准，如美国消防协会，美国采暖、制冷和空调工程师协会和地方法规指定当局发布的指导方针和安全标准。同时要遵照消防等管理部门颁布的安全标准。当燃气灶在空烧时，会产生大量热量，安装在其上方的油烟机可能会受损或着火，请仅在在有锅具时操作燃气灶。
- 为避免任何可能对产品的损害，请确保实际电压和频率与本说明书中阐明的一致。
- 请确保使用我司提供的标准配件，以防油烟机意外跌落；墙上开的洞应精准符合膨胀管的尺寸，否则，油烟机可能松动跌落。
- 本公司产品上使用了钢化玻璃，玻璃的钢化机理决定这种玻璃存在极小概率的自爆。一旦发生非使用不当的自爆，我公司承诺免费提供该配件。钢化玻璃在以下情况，发生破裂的几率可能会大大提高，请避免发生：例如用炊具或其他硬物敲击玻璃，特别是敲击玻璃四个角部；打开油烟机周围橱柜门时撞击到玻璃；玻璃处于过冷和过热、冷热交替严重的环境等情况。
- 擅自改装此产品会产生风险。

重要 

- 本产品仅用于家庭室内使用，不可用于室外。仅按照制造商的方式使用本产品，若您在室外或特殊场合使用本产品，方太将不承担任何责任。如果您有任何问题，请联系方太授权的服务中心。
- 使用此新产品之前请开封检查此产品是否受损，如果发现此产品有明显的损坏，请勿安装使用，请您立即联系方太授权的服务中心。
- 请保持此油烟机远离石膏板粉末、建筑尘埃等物质。
- 请仅以本说明书指定的方式使用。请不要在无人看管情况下运行此产品。如有疑问，请联系方太授权的服务中心。
- 作为使用者，您对家中的油烟机负有清洁保养和正确使用责任。
- 根据实际条件清理金属油网。
- 油烟机电机有热过载功能，此功能在电机过热时会自动关闭电机，当电机冷却下来后会重新启动，如果电机不断关闭、重启，请联系方太授权的服务中心。
- 油烟机若长期不用，请拨下电源插头。
- 请确保此产品正确的安装和维修。此产品必须符合所有适用的规范和标准，包括防火建筑的规范和标准，由合格技师进行正确安装和接地。安装人员负责确保此产品在其安装位置正常工作。
- 请按照当地法律法规要求安装止逆阀。
- 仅用于一般排气使用。请不要使用此油烟机排放有害或爆炸性材料和气体。
- 产品自身不可燃。
- 为降低火灾危险，所有排烟管、烟道和设备应是不可燃的，请仅使用金属管道。绝不用可燃塑料或纸张覆盖油烟机。
- 保修服务须由方太公司认可的服务机构或人员执行。如私自拆机维修，产品将不享受保修。
- 请阅读油烟机上的规格标签，以便了解更多信息和要求。

- 如用户房屋密封，安装有大功率烟机，建议安装补充空气装置。方太油烟机的配置，建议密封性高的新房用户安装补充空气装置。如所属州或地区有相关法律规定要求，请遵守相关法律规定要求安装相应补充空气装置。
- 本产品仅限于美国和加拿大使用。

使用方法

主要技术参数

| | | | |
|---|-----------|----------------------|----------|
| 型号 | EMS9026 | | |
| 认证 | ETL | | |
| 产品尺寸 | 宽度 | 35 5/16inches(896mm) | |
| | 深度 | 20 5/16inches(515mm) | |
| | 高度 | 25 1/4inches(640mm) | |
| 电压/频率 | 120V/60Hz | | |
| 整机功率 | 310W | | |
| LED灯功率 | 2W | | |
| 风档 | 低档 | 高档 | 自动巡航增压模式 |
| 风量(m ³ /h) | 600 | 770 | 1030※ |
| 噪音(dB(A)) | 43 | 48 | 54 |
| 最大静压值(Pa) | 350 | 420 | 500 |
| <p>a.1030※:自动巡航增压模式下，吸油烟机会自动检测烟道阻力，当烟道阻力大于产品设定的阻力时，风机自动跳到增压模式运行，此模式下风量可达1030m³/h。</p> <p>b.上表dB噪音按照IEC 60704-3-2006标准，为声压级噪音，对应声功率级噪音为：自动巡航增压模式68dB(A)、高档62dB(A)、低档57dB(A)。</p> <p>c.已按照IEC 61591-2010标准对表中所列风量进行测试。</p> <p>d.风量、噪音等参数可能存在5%以内的偏差。</p> | | | |

使用说明

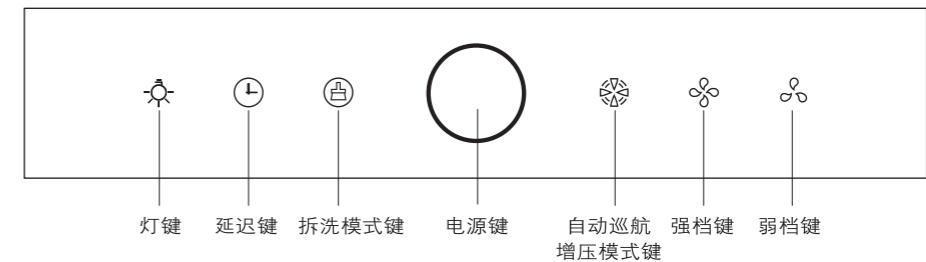

操作界面说明



调试及功能说明

- 电源键
关机状态下按一次○，进入待机状态，2分钟内无其它按键操作，自动关机。
工作/待机状态下，按一次○，吸油烟机关闭。
以下功能键皆在电源键开启情况下有效。
- ☀ 灯键
无照明时，按☀一次，照明灯打开，再按☀一次，照明灯关闭。
- ⌚ 延迟键
吸油烟机在待机模式下或在运行的模式下，按一下⌚，执行延时关机功能，2分钟后所有功能关闭。如需取消延时，按任意键即可。
- 🧼 拆洗模式键
4.1 按一下🧼照明灯开启，蝶翼板下降到最低位置，进入清洁保养状态，再按一下🧼，蝶翼板上升到最高位置；
4.2 拆洗模式键与🌀☀⌚互斥，当上述四种功能中的一种有启用时，点击拆洗模式键，则退出相应的功能模式。在清洁保养状态下🌀☀⌚无效；
4.3 清洁保养状态下按○蝶翼板立刻上升到最高位置。
- 🌀 自动巡航增压模式键
吸油烟机在待机模式下或在运行的模式下，按一下🌀键指示灯全亮，吸油烟机进入自动巡航增压模式，此时吸油烟机会自动检测烟道阻力，当烟道阻力大于设定值时，风机自动跳到增压模式运行，如果烟道阻力恢复正常，则30秒后吸油烟机跳回常态模式强档运行。如果要关闭此功能，按🌀键即可。
- 🌀 强档键
按一下，风机启动，🌀键指示灯点亮，吸油烟机在强档运行，再按一下，风机关闭。
- 🌀 弱档键
按一下，风机启动，🌀键指示灯点亮，吸油烟机在弱档运行，再按一下，风机关闭。

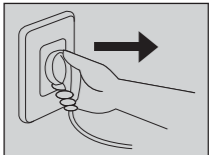
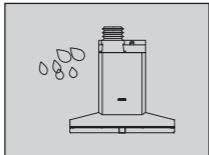
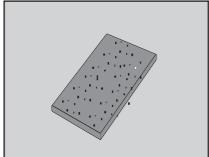
清洁保养

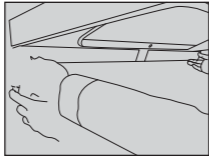
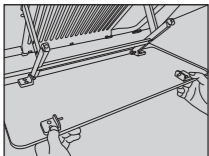
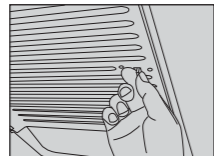
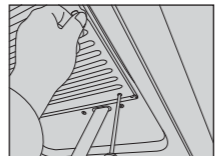
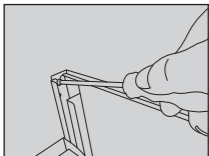
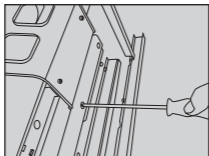
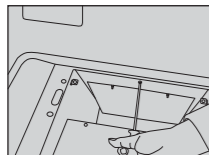
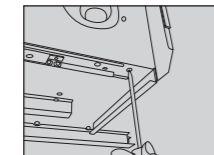
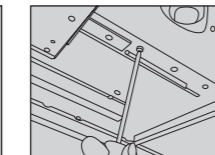
| | | | |
|---|---|--|--|
|  | <p>1.进行清洁之前断开电源。</p> |  | <p>2.所有电子元件(包括电机和开关等)均需远离水源。</p> |
|  | <p>3.请勿使用粗糙材料(例如钢丝球、刷子或粗布等)清洁产品表面。否则将严重划伤表面。</p> |  <p>中性清洁剂</p> | <p>4.请勿使用汽油、酸性物质、苯、溶剂和其他化学试剂进行清洁。如需清洁产品,请使用中性清洁剂并在清洁后使用软布将产品表面擦干。</p> |
|  <p>湿布</p> | <p>5.如不锈钢面板沾有含盐液体、消毒剂、漂白粉和其他清洁剂,请立即使用湿布将其擦净,然后使用干布将其擦干。</p> |  | <p>6.双手握住油杯两端使其保持水平状态,然后缓慢将其从吸油烟机前端旋出,取下油杯后倒出积油。</p> |
|  |  |  | <p>7.第一,按下拆卸和清洗键将蝶翼板降低至最低位置,然后双手抓住蝶翼板前缘使其向下翻转,使蝶翼板卡扣脱离,然后再次向下翻转一定角度以便取下蝶翼板。第二,按外网卡扣,取下外网。第三,左手托住内网,右手用十字螺丝刀旋出固定内网的两颗螺钉;然后取下内网。</p> |
|  | <p>8.用十字螺丝刀旋出固定风机外罩的两颗螺钉;然后取下风机外罩和装饰罩。</p> |  | <p>9.用十字螺丝刀旋出连杆螺钉(左右各两颗),然后卸下升降杆。</p> |
|  |  |  | <p>10.使用十字螺丝刀旋出风机架上的五颗螺钉(左右各一颗;顶部三颗),旋出左右两侧的四颗螺钉,旋出风机外罩上的螺钉,然后卸下风机盖板。</p> |

| | | | |
|---|----------------------------|---|--------------------------------|
|  | <p>11.使用十字螺丝刀旋出进风圈的螺钉。</p> |  | <p>12.沿顺时针方向旋出锁紧螺母,然后取下叶轮。</p> |
|---|----------------------------|---|--------------------------------|

- a.当清洁、维修吸油烟机前,务必先拔掉电源线插头,以免触电。
- b.每次使用吸油烟机后,请擦拭吸油烟机外表面、蝶翼环吸板和油杯。
- c.所用灯为LED灯:灯功率为2W,电压范围为9~10V,灯尺寸为宽度7 7/8" (199.3mm)/深度1"(24mm)/高度2"(49.4mm)。







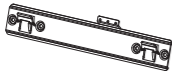
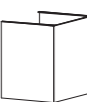

常见故障的识别和处理

| 故障 | 可能原因 | 检修方法 |
|--------------------|---------------------|------------------------------|
| 按开关,吸油烟机不工作,LED灯不亮 | 未接通电源 | 检查电源插头是否插好 |
| | | 检查插座是否有电 |
| 电机转动但LED灯不亮 | LED灯损坏 | 更换LED灯 (本项必须由专业人员进行) |
| 有机械振动噪声 | 螺钉松动 | 检查吸油烟机表面螺钉是否拧紧 |
| 吸力不强 | 吸油烟机与灶面的安装距离太大 | 降低吸油烟机的安装高度 (本项必须由专业人员进行) |
| | 吸油烟机周围环境门窗通风太多,对流太大 | 关闭部分门窗 |

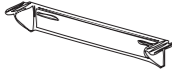
- a.更换LED灯,请联系方太授权的服务中心。
- b.上述故障排除后,吸油烟机仍不能正常工作,请联系方太授权的服务中心。
- c.保修期内保修需提供以下信息:
 1. 购买日期
 2. 产品型号
 3. 序列号
 4. 购买相关凭证
- d.其他人员不得擅自维修吸油烟机,以免造成严重后果,而且产品将不享受保修服务。
- e.以下情况不提供保修服务:
 1. 用户搬运、安装、使用、维护、保管不当而损坏的。
 2. 超出正常使用条件,强行使用本产品造成的故障和损伤(例如电压超出132V或低于103.2V而损坏的)。
 3. 自行或非方太指定服务人员或服务机构安装和拆修的产品。
 4. 购买凭证和保修卡信息与产品不符的。
 5. 因不可抗力造成产品损坏的(如自然灾害、战争等)。
 6. 不根据“使用说明书”的规定使用,造成产品故障或损伤的。

安装

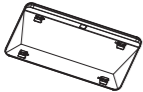
装箱单

| 标准配置 | |
|--|---|
| 整机  | 1 |
| 挂钩  | 1 |
| 装饰罩  | 1 |
| 油杯  | 1 |
| 装饰罩挂钩  | 1 |
| 金属密封垫  | 1 |
| 使用说明书  | 1 |
| 保修卡  | 1 |
| 蝶翼板组件  | 1 |
| 防撞配件  | 2 |

| 标准配置 | |
|---|---|
| 金属出风罩  | 1 |
| 外网  | 1 |
| 瓷砖膨胀管 Φ1/4"×1 5/16"(Φ5.3×32mm)  | 6 |
| 灰板膨胀管 Φ3/16"×1 5/8"(Φ4×40mm)  | 6 |
| 挂钩螺钉 #8×1 7/16"(ST4.2×36mm)  | 6 |
| 木螺钉 #10×2 9/16"(ST5×65mm)  | 4 |
| 十字槽盘头自攻锁紧螺钉 #8×1/2"(M4×12mm)  | 8 |
| 十字槽盘头自攻锁紧螺钉 #4×3/4"(ST2.9×19mm)镀锌  | 2 |
| 十字槽大扁头自攻锁紧螺钉 #8×3/8"(M4×8mm)镀锌  | 2 |

安装警告

为确保方太产品的安全和高效使用，请注意产品说明书中以下突出显示信息：

警告：标明如不遵守预防措施则可能导致严重人身伤害或死亡等危险。

注意：表示如不遵守指导说明则可能出现轻微人身伤害或产品损坏。

重要：强调非常重要的信息。

安全须知

请确保在使用产品前阅读此安全须知

请务必保留此安全须知信息

本产品仅限室内家用

警告 

- 为降低火灾、电击或人身伤害危险，请注意以下事项：
 - 油烟机的安装以及电路的设置必须要由有经验的专业人员进行，非专业人员请勿安装。在安装时要遵守所有相关的法规、标准，包括与火灾有关的说明。正确安装是安装人员的责任。由于安装不当导致的产品故障不包括在方太保修范围内。
 - 为确保安全和安装顺利，请使用随机附件进行安装；安装膨胀管时，膨胀管与墙孔的配合一定要紧密，严禁钻孔过大，以免膨胀管松动，造成意外跌落！
 - 油烟机应使用专用电源插座，并且专用电源插座应有可靠接地。因电源线中途连接、使用延长线以及多口配线器时易发生触电、插头插座发热以及火灾。装电线前请切断电源，请确保采取合理措施避免意外电源接通。
 - 安装时不能接通电，应在主电源箱中关闭电源。如果电源线损坏，必须由制造厂商或其服务代理提供的单独特配电源线或套件进行替换。
 - 用户自行安装易发生触电、脱落、起火等危险。非专业人员请勿拆卸、安装及维修油烟机。
- 人身伤害危险：
 - 在移动油烟机进行安装、清洁或者修理前，务必切断电源，以免触电。
 - 油烟机可能有非常锋利的边，在进行安装、清洁或修理时，应佩戴合格的防护手套，以防被油烟机内金属板快口等划伤和擦伤。

● 安装前的警告：

- 为了不对油烟机造成损害，请确保不要让杂物等进入排风口。
- 直线、较短的出风管布置将使得油烟机的排烟更加顺畅。
- 尽量避免使用过长以及有较多弯道的出风管，使用这些管道将影响油烟机的排烟效果。
- 出风管与墙孔的连接处使用管道胶严格进行密封。必须确保出风管与出风罩连接牢固，并用铝箔胶带密封。
- 墙洞过小会影响排烟效果，在保证安全的前提下，建议扩孔至6"(150mm)或以上。
- 本产品上使用的都为公制尺寸螺钉，请不要随意使用不符合规格要求的螺钉。

注意 

● 在安装以前，请仔细阅读所有的说明。特别请注意以下事项：

- 如果您正在对您的厨房进行装修，请勿将油烟机暴露在外。因为建筑材料、灰尘、油漆、涂料以及它们所挥发的的气体，会使油烟机表面产生腐蚀以及失去光泽。建议在厨房装修完毕后再安装油烟机。
- 如果在安装油烟机前，需要移动燃气灶，则在移动燃气灶之前，请先关闭燃气总阀门。
- 油烟机排出的废气不能排放到用于排出燃烧燃气或其他燃料的烟雾使用的热烟道中。
- 因油烟机的尺寸较大和重量较重，建议两位安装人员安装。由于本油烟机的安装程序复杂，因此需要专业安装维修人员按照此说明书进行安装。
- 产品固定后，插头应在可接触位置。
- 安装时须保证机身水平。
- 安装完毕，请确认油烟机运转无异常现象。

重要 

- 请在安装前阅读所有安装指导，保存此说明书以备当地巡检参考和日后参阅。
- 此产品安装必须遵守国家电力法，也要遵守各个州、市政和地方的法规。
- 请为此产品配备合适的断路器，并在安装时将产品可靠接地。
- 必须根据产品铭牌上提供的电压、频率和安培给产品配备合适的电压、频率和安培额定值。
- 此安装必须由方太授权的服务中心或其认可的安装人员完成。
- 安装油烟机前请记录下产品型号和序列号。产品型号和序列号请参考以下图示A说明。

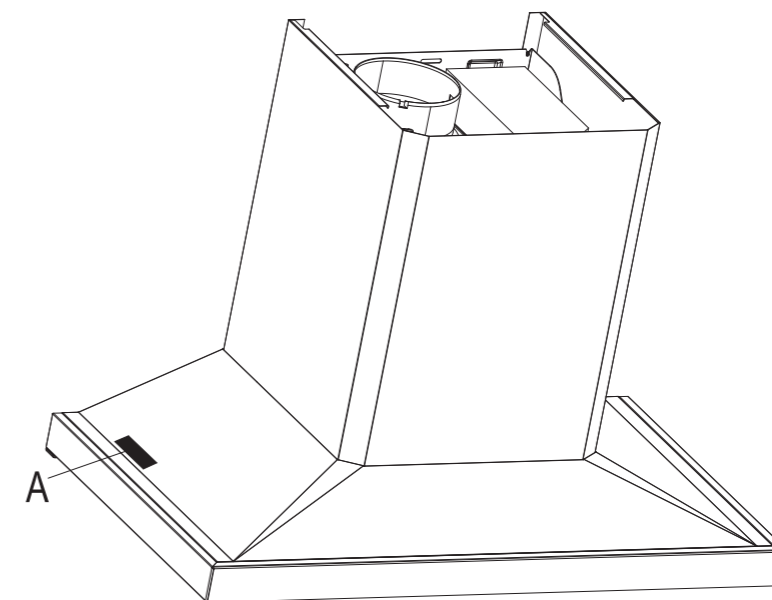

产品尺寸图

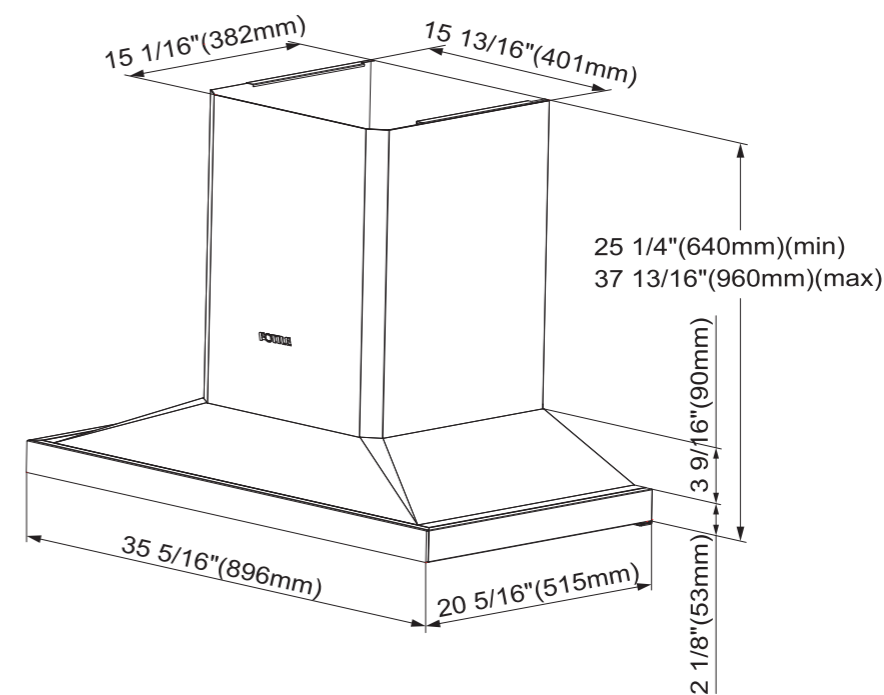

产品基本尺寸

安装建议

■ 吸油烟机安装示意图

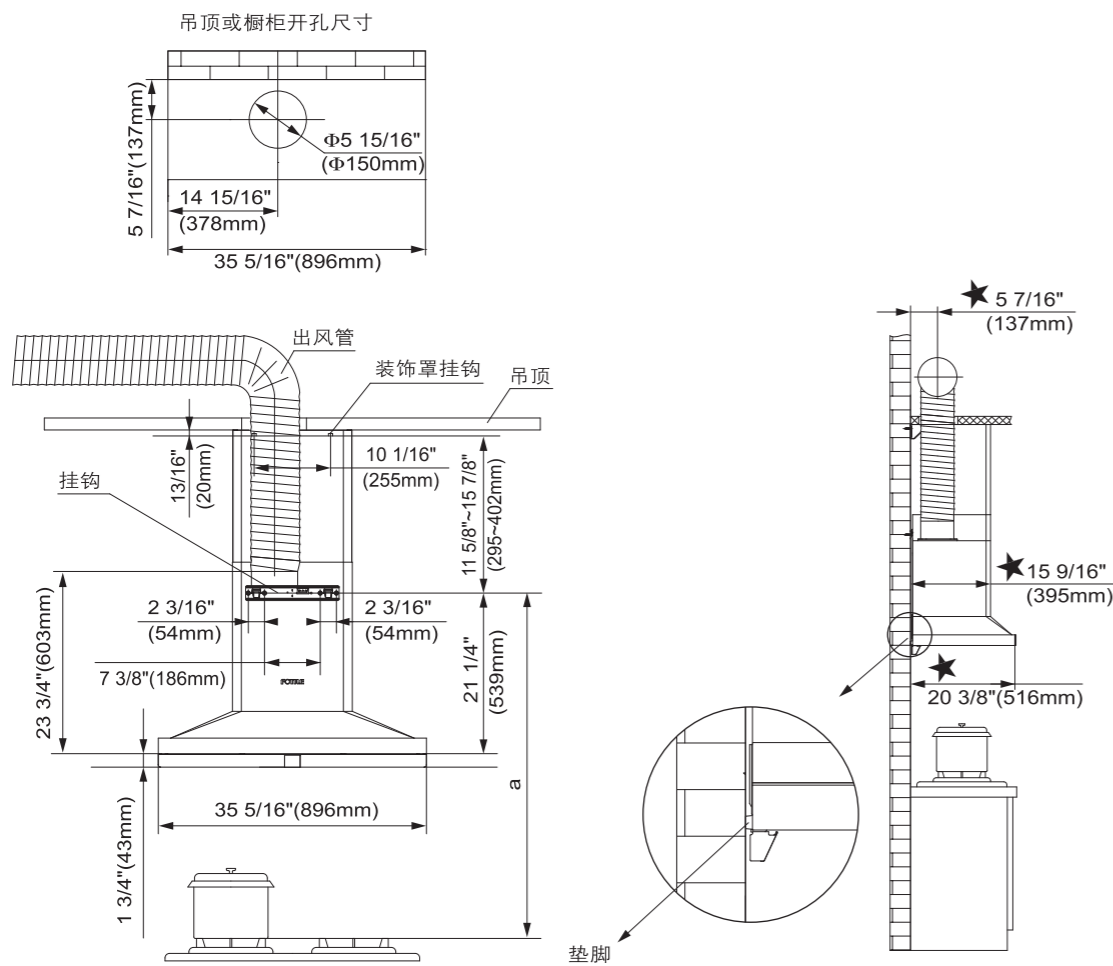

安装示意图 (★表示到墙的距离)
 a=46 15/16"~48 9/16"(1192mm~1232mm)(美国)
 a=48 9/16"~50 1/2"(1232mm~1282mm)(加拿大)

💡 吸油烟机的安装高度(即炉灶上烹饪器具的支承面与吸油烟机最低部位的距离)为 24 1/16"~25 5/8"(610mm~650mm)(美国)/25 5/8"~27 9/16"(650mm~700mm)(加拿大), 此安装高度为推荐值, 图示橱柜与吸油烟机搭配示意仅供参考, 当本产品的安装高度(即炉灶上烹饪器具的支承面与吸油烟机最低部位的距离)低于24 1/16"(610mm)(美国)/25 5/8"(650mm)(加拿大)时, 低于24 1/16"(610mm)(美国)/25 5/8"(650mm)(加拿大)部分的所有部件均为吸油烟机的不易燃部件或工作在安全特低电压下的部件, 且这些部件变形时, 不会影响对触及带电部件的防护。(如所属地区有相关法律规定油烟机安装高度, 建议遵守相关法律, 但产品的吸油烟效果可能会受到一定影响。)

■ 安装前的准备工作

- 1.警告: 为了不对吸油烟机造成损害, 请确保不要让杂物等进入排风口。估算吸油烟机通到室外的出风管的位置, 参见安装示意图。一个直线的、较短的出风管将使得吸油烟机的排烟更加顺畅。出风管与墙孔的连接处使用管道胶带严格进行密封。必须确保出风管与出风罩连接牢固。墙洞过小会影响排烟效果, 在保证安全的前提下, 建议扩孔至出风管尺寸。
- 2.工具准备
 安装本吸油烟机应具备以下工具(包括并不限于以下工具):
 (1) 冲击电钻(带钻头Φ10mm) (2) 十字螺丝刀
 (3) 卷尺 (4) 水平尺

安装步骤

1. 冲击电钻应配备Φ10mm冲击钻头备用。
2. 如安装示意图所示, 在坚实的墙壁上准确确定冲击钻钻孔的位置, 钻孔并牢固埋设膨胀管, 固定挂钩和装饰罩挂钩, 旋入#10×2 9/16"(ST5×65mm)木螺钉拧紧; 装饰罩挂钩前端可用2颗#4×3/4"(ST2.9×19mm)十字槽自攻锁紧螺钉加强固定到吊顶上(如图1和图2所示)。
3. 如图3所示, 用8颗#8×1/2"(M4×12mm)出风罩螺钉将出风罩及密封圈固定在主机顶部上。
4. 将出风管固定在出风罩上, 用铝箔胶带缠绕密封(如图3所示)。
5. 牢挂主机, 正视—不歪不斜, 侧视—机体贴墙面, 与墙壁间略有缝隙。
6. 按(安装示意图)安装出风管, 检查管壁不鼓不瘪, 弯角自如, 出风管与墙壁间密封严密以防倒烟。
7. 安装蝶翼板:
 (1) 双手紧握蝶翼板前侧, 把蝶翼板后侧的左右挂钩, 放入集烟罩的左右挂钩架内;
 (2) 双手托住蝶翼板, 使其往上旋转, 蝶翼板旋转同时往里推, 最后使蝶翼板上的碰爪刚好插入集烟罩上的碰扣内。
8. 将主机电源插头插入电源插座。
9. 风机外罩、装饰罩安装(如图4所示):
 (1) 将装饰罩放入风机外罩;
 (2) 把风机外罩、装饰罩同时拿起, 先把装饰罩卡入装饰罩挂钩内, 然后同时将装饰罩、风机外罩沿装饰罩挂钩组件推到底;
 (3) 把装饰罩、风机外罩推到底后, 风机外罩缓缓滑下来, 将风机外罩卡扣卡入风机架, 然后将风机外罩插入顶板与风机架的间隙内。
10. 安装防撞配件: 先确定防撞配件磁力面(如图5所示), 再将防撞配件贴在吸油烟机角部(如图6所示)。
11. 装上油杯组件(如图7所示)。



图1



图2

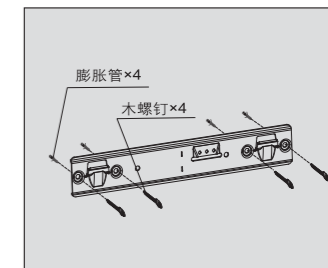

图3

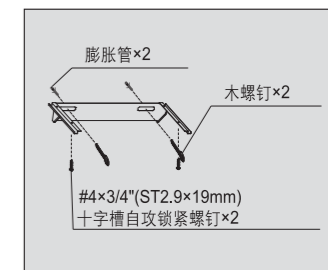

图4

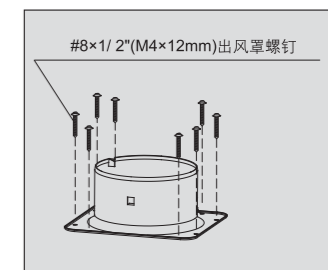

图5

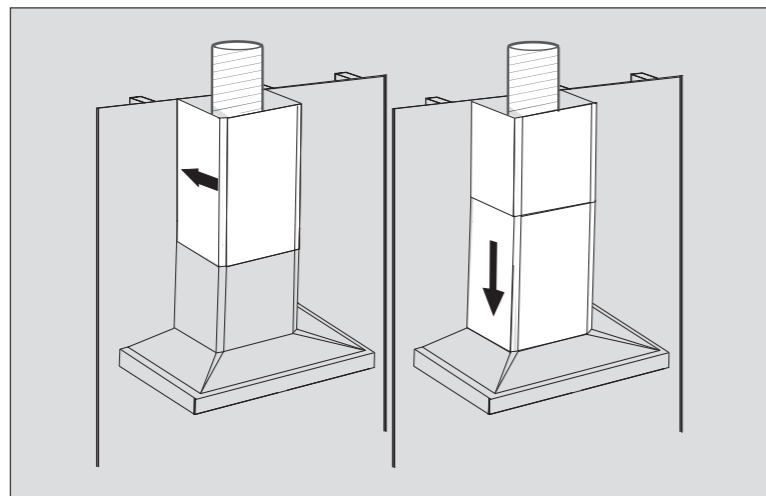

图6

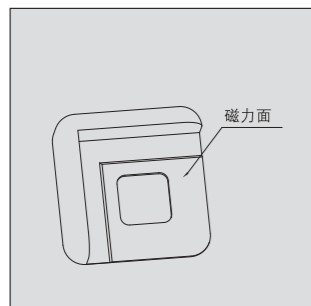

图7

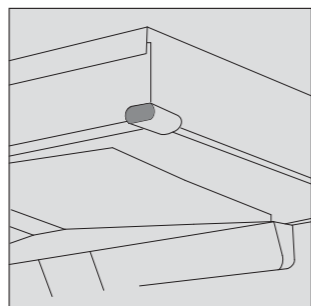

- a. 安装前先取下风机外罩；
- b. 若与橱柜配合安装，步骤4与步骤5互换；
- c. 根据钻孔地方的具体情况选定钻头。

安装后的调试

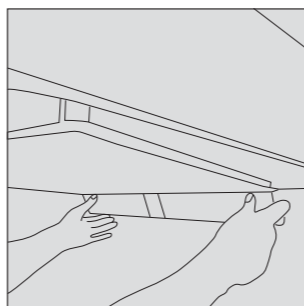
1. 装上油杯；
2. 将电源线插入插座；
3. 按下电源键，检查照明灯是否正常工作；
4. 按下强/弱档键或自动巡航增压模式键，检查电机转动是否正常，如出现下列异常情况，应立即切断电源，停止运转，并检查是否为安装缘故（若确定吸油烟机发生故障，请致电方太授权的服务中心）：
 - (1) 机体震动剧烈
 - (2) 膨胀管松动
 - (3) 叶轮不转动
 - (4) 叶轮转动时有明显摩擦声
 - (5) 电机出现异常声响
5. 按下电源键，风机停止转动。
 - (1) 如果电源软线损坏，为了避免危险，必须由制造商、其维修部或类似部门的专业人员更换；
 - (2) 当吸油烟机与燃烧燃气或其他燃料的炉灶同时使用时，房间必须通风良好。

正确处理产品



此标记表示本产品不应与其他家庭垃圾一起处理。为防止不合理的废品处理可能会对环境或人类健康造成危害，需要对本产品合理回收利用，以促进材料、资源的可持续利用发展。如您需要退回使用过的机器，请使用回收采集系统或联系相关零售商，他们会把机器环保、安全的回收利用。

爆炸图

