



**FIREMAGIC**<sup>®</sup>

Premium Outdoor Grills



## **FIRE MAGIC® BRINGS OUT THE BEST IN YOUR GRILLING**

Family owned and crafted in America, Fire Magic® is the name trusted by true grilling enthusiasts for over 80 years. With an extensive product line, versatile cooking options, enhanced durability and superior design innovations, Fire Magic® is the finest performing grill on the market and a shining centerpiece for a lifetime of special moments shared with family and friends.



## **BUILT WITH PASSION. OWNED WITH PRIDE.**

Fire Magic® grills are made by people who demand the best, for people who demand the best. Every Fire Magic® grill is manufactured in our U.S. production facility and held to the strictest quality standards and the highest performance metrics. Using state-of-the-art technology, guided by the watchful eye and careful hand of master craftsmen, and backed by the industry's best warranty, our grills are an investment to be enjoyed for years to come.

## **BEAUTIFULLY DESIGNED. BULLET PROOF TOUGH.**

Constructed entirely of the finest quality, heavy-gauge 304 stainless steel with unsurpassed attention to the most precise detail in design and construction, Fire Magic® grills are the most elegant and durable barbecue grills available. They are engineered to perform at the highest temperature for the longest time of any outdoor barbecue grill. Our exclusive advanced heat distribution system, searing options, smoking capability, rotisserie, and charcoal grilling features allow you to grill any meal imaginable with ease and exceptional results. Fire Magic will keep you grilling and the neighbors talking for years to come.

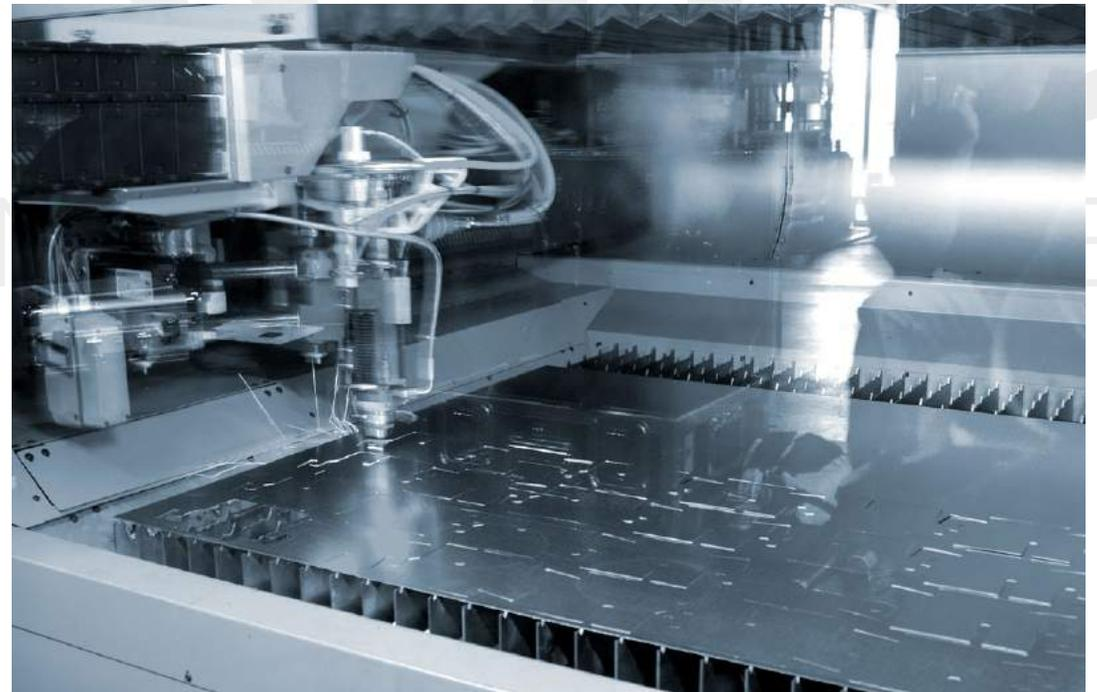

## Diamond Sear Cooking Grids \*

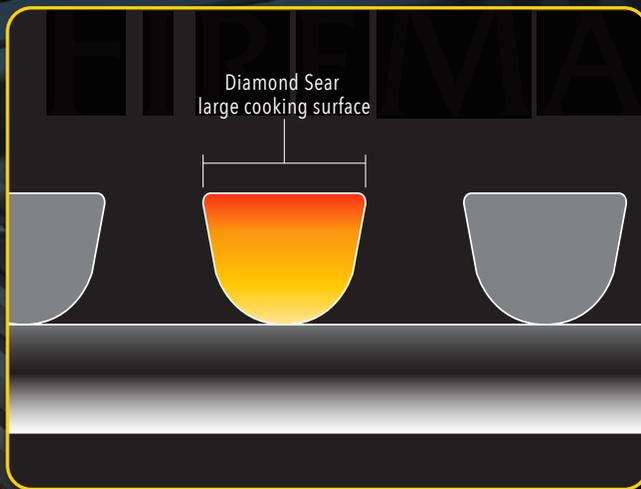

- Diamond Sear cooking grids promote more optimal heat transfer to food. Their shape with angled sides improves the flow of heat to the cooking surface.
- Diamond Sear cooking grids are easier to cook on as foods stick less to the cooking surface than round cooking grids.
- Diamond Sear cooking grids have more contact surface than round grids. This provides more points of contact that help to sear your meat better and faster.
- More efficient heat transfer and quicker cooking result in less use of gas.

\* U.S. Patent No.: D857,453 & D862,984

# Advanced Heat Distribution System

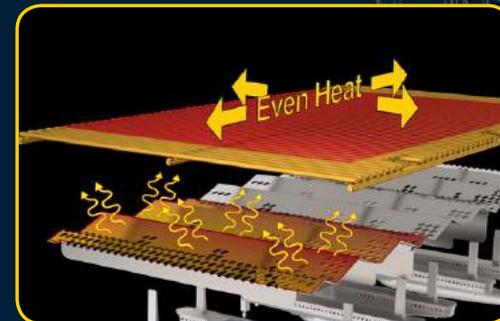
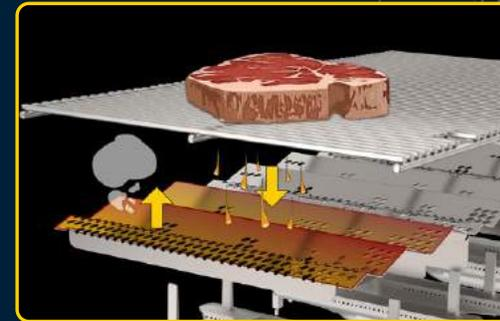

## Zone Flavor Grids

- Heavy gauge stainless steel flavor grids minimize flare ups, provide quick and even heat distribution, and flavor food by vaporizing juices.
- Designed to provide distributed heat to the cooking grids; they don't retain or block heat from rising.
- Integrated Zone Separators create zones for cooking varied foods at different temperatures.
- Easy to clean and maintain.
- Simple to remove when rotisserie cooking (for largest rotisserie area).

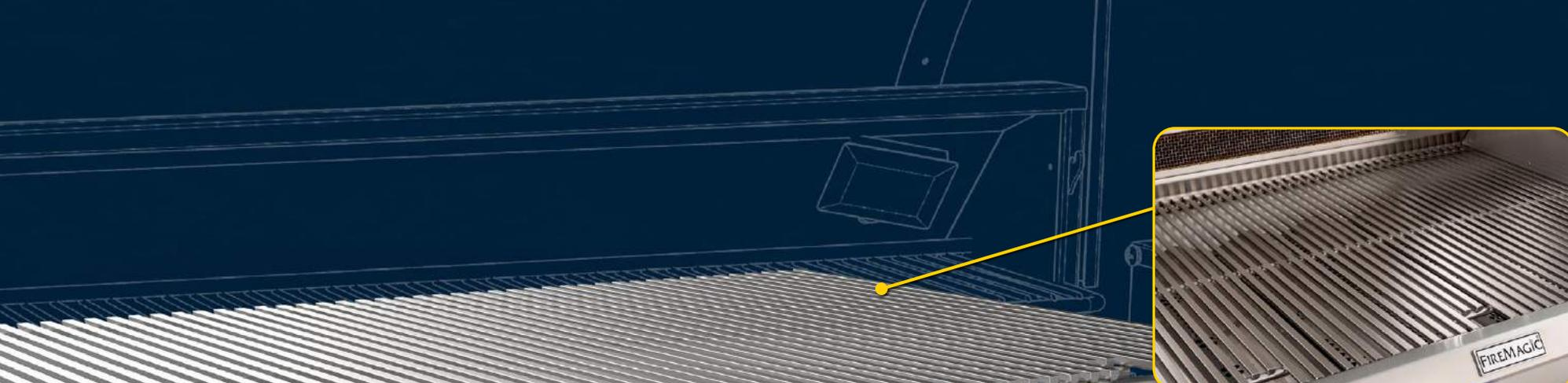

### Largest Cooking Area

Fire Magic® grills provide more cooking area than other grills and more BTU's per square inch of cooking surface.

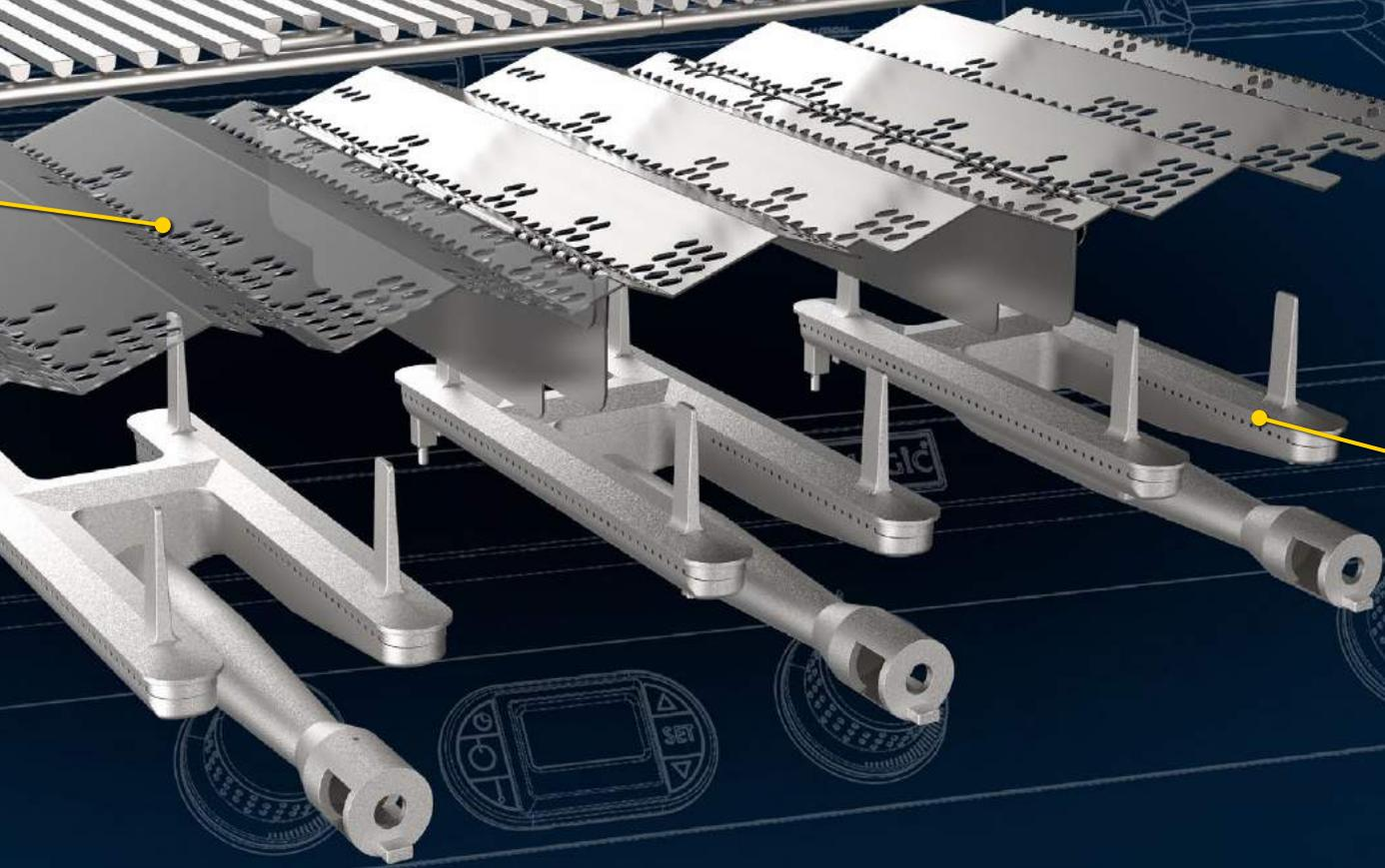

### Cast Stainless Steel "E" Burners

- 1/4" thick cast stainless steel burners weighing up to 12 lbs. each.
- Precision porting - cast to be evenly spaced on each burner.
- An internal baffling system and carry over slots designed for ease of lighting, and balancing flame and heat; to provide well distributed heat, on high or low in each burner.



# ECHELON

 DIAMOND SERIES

## Echelon Diamond Series

When only the best will do, our top of the line Fire Magic® Echelon Diamond combines the ultimate in performance, beauty, and innovation. With sleek lines, a unique contoured face, state-of-the-art features such as hot surface ignition, blue back-lit knobs, and an optional Magic View Window, Echelon Diamond defines luxury in grilling.

# ECHELON DIAMOND SERIES FEATURE HIGHLIGHTS

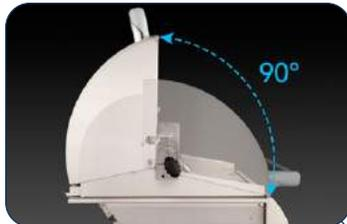

Seamless, 90° hood w/ Spring Assist



Angled Interior Halogen Lights



Premium, High Efficiency Backburner with Rotisserie Kit



Dual Position Warming Rack



Diamond Sear Cooking Grids



Hot Surface Ignition



Zone Flavor Grids



Contoured Face w/ Back-Lit Knobs



Charcoal / Smoker Basket



Cast Stainless Steel Burners



Digital Thermometer



Easy-to-Use Drip Tray w/ Aluminum Liner



Meat Probe with Storage Box





### Diamond Sear Cooking Grills\*

All 304 stainless steel cooking grids provide more optimal cooking surface for even heat and great searing.

\*U.S. Patent No.: D857,453 & D862,984

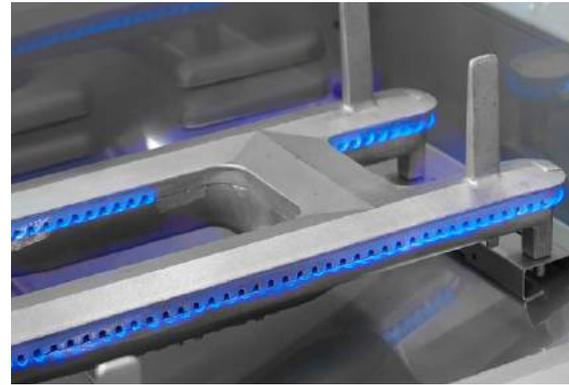

### Cast Stainless Steel Burners

1/4" thick cast stainless steel "E" burners for consistent, even heat and a lifetime of durability.



### Zone Flavor Grids

16-gauge stainless steel flavor grids are engineered for durability, even heat distribution, and reduced flare-ups.



### Digital Thermometer

Illuminated chromed digital thermometer with meat probe, timer, and alarm settings for precise grilling.



### Angled Interior Halogen Lights

12 Volt angled halogen lights make evening grilling a breeze.



### Hot Surface Ignition

Hot surface electronic ignition provides reliable lighting for every meal. Requires 120 Volt AC power supply.



### Contoured Face w/ Back-lit Knobs

Smooth, seamless lines with polished highlights that feature back-lit knobs (at 41°) with comfort touch grips and flame icons for convenience.



### Adjustable, Dual Position Warming Rack

Dual position stainless steel warming rack for easier use and storage.



### Charcoal / Smoker Basket

Included with all Echelon Diamond Grills. Great tool for charcoal grilling and smoking.



### Easy-to-Use Drip Tray

Large capacity drip tray with ball bearing glides for smooth open and close.



### High Efficiency Backburner w/ Rotisserie Kit

Recessed premium backburner uses less BTU's to generate even, efficient high heat for rotisserie cooking. Includes complete rotisserie kit with super heavy duty motor, stainless steel spit rod, counter-balance, meat prongs, and polished stainless steel cover.



### Meat Probe With Storage Box

Meat probe included with all Echelon digital grills and features a braided stainless steel sleeve and decorative wood box.



Optional Magic View Window

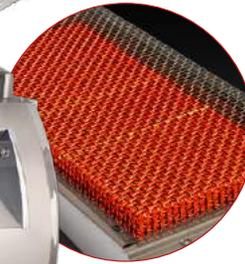

Optional Infrared Burner on the left side



E1060i-8E1N  
w/ Digital Thermometer



E1060i-8E1N-W  
w/ Digital Thermometer & Magic View Window



E1060i-8E1N  
w/ Analog Thermometer



E1060i-8E1N-W  
w/ Analog Thermometer & Magic View Window

## Echelon E1060i, 48" Built-In Grill

E1060i-8E1N\*-W (optional Magic View Window shown)

### KEY FEATURES

- Heavy duty, patented **Diamond Sear** cooking grids
- Cast stainless steel "E" burners
- Heavy gauge stainless steel dual position, adjustable warming rack
- Heavy gauge all stainless steel **Zone Flavor Grids**
- Push-to-Light **Hot Surface Electric Ignition** system w/ flash tubes
- Angled halogen 12 Volt internal oven lamps
- Contoured control panel w/ bright polished trim & polished, back-lit knobs
- Digital chrome meat & grill thermometer in control panel or angled analog thermometer in lid measuring up to 1000° F
- Seamless double wall 90° hood with feather-lite easy Lift Lid
- Recessed, premium high efficiency rotisserie **Backburner**

### KEY FEATURES (continued)

- **Charcoal/Smoker Basket** included with all Echelon grills
- Optional infrared sear burner
- Optional **Magic View Window** in lid
- Custom personalized name plate

### SPECIFICATIONS

- Primary cooking surface: **48" x 22" (1,056 sq. in.)**
- Warming rack surface: **48" x 8" (344 sq. in.)**
- Main burners: **112,000 BTU's**
- Backburners: **22,000 BTU's (11,000 x 2)**
- Cut-out dimensions: **50" w x 23½" d x 11½" h**

\*All models available in natural gas or propane (for propane, change **N** to **P** in the model number).

## Echelon E1060s, 48" Portable Grill

**E1060s-8E1N\*-62-W** (optional Magic View Window shown)

- Primary cooking surface: **48" x 22" (1,056 sq. in.)**
- Warming rack surface: **48" x 8" (344 sq. in.)**
- Main burners: **112,000 BTU's**
- Backburners: **22,000 BTU's (11,000 x 2)**
- Single Side Burner: **15,000 BTU's**



### Single Side Burner

Flush mounted on left side shelf with 15,000 BTU's burner and stainless steel grate.

## Echelon E1060s, 48" Portable Grill

**E1060s-8E1N\*-51-W** (optional Magic View Window shown)

- Primary cooking surface: **48" x 22" (1,056 sq. in.)**
- Warming rack surface: **48" x 8" (344 sq. in.)**
- Main burners: **112,000 BTU's**
- Backburners: **22,000 BTU's (11,000 x 2)**
- Power Burner: **60,000 BTU's**



### Power Burner

60,000 BTU's Power Burner with lid mounted on the left side.

\*All models available in natural gas or propane (for propane, change **N** to **P** in the model number).



Optional Magic View Window

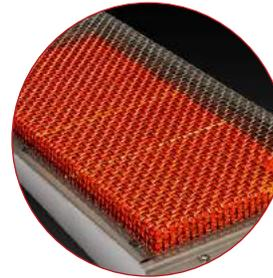

Optional Infrared Burner on the left side

## Echelon E790i, 36" Built-In Grill

E790i-8E1N\*-W (optional Magic View Window shown)

### KEY FEATURES

- Heavy duty, patented **Diamond Sear** cooking grids
- Cast stainless steel "E" burners
- Heavy gauge stainless steel dual position, adjustable warming rack
- Heavy gauge all stainless steel **Zone Flavor Grids**
- Push-to-Light **Hot Surface Electric Ignition** system w/ flash tubes
- Angled halogen 12 Volt internal oven lamps
- Contoured control panel w/ bright polished trim & polished, back-lit knobs
- Digital chrome meat & grill thermometer in control panel or angled analog thermometer in lid measuring up to 1000° F
- Seamless double wall 90° hood with feather-lite easy Lift Lid
- Recessed, premium high efficiency rotisserie **Backburner**

### KEY FEATURES (continued)

- **Charcoal/Smoker Basket** included with all Echelon grills
- Optional infrared sear burner
- Optional **Magic View Window** in lid
- Custom personalized name plate

### SPECIFICATIONS

- Primary cooking surface: **36" x 22" (792 sq. in.)**
- Warming rack surface: **36" x 8" (288 sq. in.)**
- Main burners: **90,000 BTU's**
- Backburner: **13,000 BTU's**
- Cut-out dimensions: **37" w x 23½" d x 11½" h**



E790i-8E1N  
w/ Digital Thermometer



E790i-8E1N-W  
w/ Digital Thermometer & Magic View Window



E790i-8EAN  
w/ Analog Thermometer



E790i-8EAN-W  
w/ Analog Thermometer & Magic View Window

\*All models available in natural gas or propane (for propane, change **N** to **P** in the model number).

## Echelon E790s, 36" Portable Grill

**E790s-8EAN\*-62-W** (optional Magic View Window shown)

- Primary cooking surface: **36" x 22" (792 sq. in.)**
- Warming rack surface: **36" x 8" (288 sq. in.)**
- Main burners: **90,000 BTU's**
- Backburner: **13,000 BTU's**
- Side Burner: **15,000 BTU's**



### Single Side Burner

Flush mounted on left side shelf with 15,000 BTU's burner and stainless steel grate.

## Echelon E790s, 36" Portable Grill

**E790s-8EIN\*-71-W** (optional Magic View Window shown)

- Primary cooking surface: **36" x 22" (792 sq. in.)**
- Warming rack surface: **36" x 8" (288 sq. in.)**
- Main burners: **90,000 BTU's**
- Backburner **13,000 BTU's**
- Double Side Burner: **30,000 BTU's (15,000 x 2)**



### Double Side Burner

The Double side burner offers precise flame control on each burner to prepare side dishes and sauces for your meal (Two [2] 15,000 BTU's burners). Includes stainless steel grids as well as removable stainless steel cover.

\*All models available in natural gas or propane (for propane, change **N** to **P** in the model number).



Optional Magic View Window

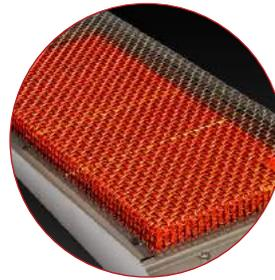

Optional Infrared Burner on the left side

## Echelon E660i, 30" Built-In Grill

E660i-8E1N\*-W (optional Magic View Window shown)

### KEY FEATURES

- Heavy duty, patented **Diamond Sear** cooking grids
- Cast stainless steel "E" burners
- Heavy gauge stainless steel dual position, adjustable warming rack
- Heavy gauge all stainless steel **Zone Flavor Grids**
- Push-to-Light **Hot Surface Electric Ignition** system w/ flash tubes
- Angled halogen 12 Volt internal oven lamps
- Contoured control panel w/ bright polished trim & polished, back-lit knobs
- Digital chrome meat & grill thermometer in control panel or angled analog thermometer in lid measuring up to 1000° F
- Seamless double wall 90° hood with feather-lite easy Lift Lid
- Recessed, premium high efficiency rotisserie **Backburner**

### KEY FEATURES (continued)

- **Charcoal/Smoker Basket** included with all Echelon grills
- Optional infrared sear burner
- Optional **Magic View Window** in lid
- Custom personalized name plate

### SPECIFICATIONS

- Primary cooking surface: **30" x 22" (660 sq. in.)**
- Warming rack surface: **30" x 8" (288 sq. in.)**
- Main burners: **75,000 BTU's**
- Backburner: **11,000 BTU's**
- Cut-out dimensions: **31¼" w x 23½" d x 11½" h**



E660i-8E1N  
w/ Digital Thermometer



E660i-8E1N-W  
w/ Digital Thermometer & Magic View Window



E660i-8E1N  
w/ Digital Thermometer



E660i-8E1N-W  
w/ Digital Thermometer & Magic View Window

\*All models available in natural gas or propane (for propane, change **N** to **P** in the model number).

## Echelon E660s, 30" Portable Grill

E660s-8E1N\*-62-W (optional Magic View Window shown)

- Primary cooking surface: **30" x 22" (660 sq. in.)**
- Warming rack surface: **30" x 8" (288 sq. in.)**
- Main burners: **75,000 BTU's**
- Backburner: **11,000 BTU's**
- Side Burner: **15,000 BTU's**



### Single Side Burner

Flush mounted on left side shelf with 15,000 BTU's burner and stainless steel grate.

## Echelon E660s, 30" Portable Grill

E660s-8EAN\*-62-W (optional Magic View Window shown)

- Primary cooking surface: **30" x 22" (660 sq. in.)**
- Warming rack surface: **30" x 8" (288 sq. in.)**
- Main burners: **75,000 BTU's**
- Backburner: **11,000 BTU's**
- Side Burner: **15,000 BTU's**



\*All models available in natural gas or propane (for propane, change **N** to **P** in the model number).



*Black Diamond*



## Echelon Black Diamond Series

The Black Diamond Edition Grill combines all the same features as the top of the line Echelon Diamond wrapped in a porcelain-coated finish with stainless steel accents. A unique and stylish design, the Black Diamond Edition grill fuses performance, beauty and innovation to deliver the very best in outdoor cooking.

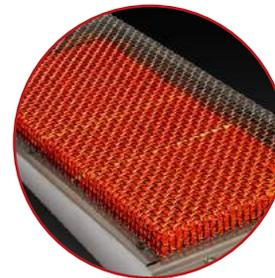

Optional Infrared Burner  
on the left side

## Black Diamond H790i, 36" Built-In Grill

H790i-8E1N\*-W (includes Magic View Window)

### KEY FEATURES

- Heavy duty **Diamond Sear** cooking grids
- Cast stainless steel "E" burners
- Heavy gauge stainless steel dual position, adjustable warming rack
- Heavy gauge all stainless steel **Zone Flavor Grids**
- Push-to-light **Hot Surface Electric Ignition** system w/ flash tubes
- Angled halogen 12 Volt internal oven lamps
- Porcelain coated finish w/ satin stainless steel trim accents & satin, back-lit knobs
- Digital chrome meat & grill thermometer in control panel
- Seamless double wall 90° hood with feather-lite easy lift lid
- Recessed, premium high efficiency rotisserie **Backburner**
- **Charcoal/Smoker Basket** included

### KEY FEATURES (continued)

- Optional Infrared Sear Burner
- Includes **Magic View Window** in lid
- Custom personalized name plate

### SPECIFICATIONS

- Primary cooking surface: **36" x 22" (792 sq. in.)**
- Warming rack surface: **36" x 8" (288 sq. in.)**
- Main burners: **90,000 BTU's**
- Backburner: **13,000 BTU's**
- Cut-out dimensions: **37" w x 23½" d x 11½" h**

\*All models available in natural gas or propane (for propane, change **N** to **P** in the model number).

*Black Diamond*



Black Porcelain Coated Finish with  
Satin Stainless Steel Accents



Magic View Window included



Satin Stainless Steel, Back-Lit Knobs



### Black Diamond Power Burner

19-H5B1N\*-0 (with stainless steel grids)

- Burner: **60,000 BTU's**
- Cut-out Dimensions: **19" w x 18 1/4" d x 11 1/2" h**
- Power Burner includes black protective lid.
- Available with porcelain cast iron or stainless steel grids.



### Black Diamond Double Side Burner

32815H\* (with stainless steel grids)

- Burners: **30,000 BTU's (15,000 x 2)**
- Cut-out Dimensions: **11 1/2" w x 22 3/4" d x 11 1/2" h**
- Double Side Burner includes black protective lid.



### Black Diamond Refrigerator

3598H-DR (-DL)

- Cut-out Dimensions: **20" w x 21 1/4" d x 34 3/8" h**
- Features Black Diamond Edition accents.
- 4.0 cubic feet of space
- Interior light and security lock & key.
- When used outdoors, it must be installed in an enclosure.



### Black Diamond Trash Cabinet

53820HTSC

- Cut-out Dimensions: **21" h x 14 1/2" w x 19 1/4" d**
- Includes two 3.25 gallon trash bins (1 black, 1 blue).
- Features Soft-Close mechanism.



### Black Diamond Double Drawer

53802HSC

- Cut-out: **16" h x 14 1/2" w x 20 1/2" d**
- Black Diamond Edition double drawer.
- Features Soft-Close mechanism.



### Black Diamond Door w/ Tank Tray & Louvers

53820HSC-TL (-TR)

- Cut-out: **21" h x 14 1/2" w x 20 1/2" d**
- Features Soft-Close mechanism.



### Single Access Door

53920HSC-L (-R)

- Cut-out: 21" h x 14½" w
- Black Diamond Edition single access door.
- Features Soft-Close mechanism.



### Double Access Doors

53938HSC

- Cut-out: 16" h x 39" w
- Black Diamond Edition reduced height double doors.
- Features Soft-Close mechanism.

*Black Diamond*



Model #: IH790-SMD-108BA

### Black Diamond GFRC Island

IH790-SMR-108BA w/ Refrigerator

IH790-SMD-108BA w/ Double Drawer

- Overall Dimensions: 107½" w x 34¾" d x 36" h
- Black Diamond Edition GFRC Island with Smoke Base, Polished Black Lava Top & black trim.
- Black Diamond grill components sold separately.



Model #: IH790-SMR-108BA



# AURORA

S E R I E S

## Aurora Series

Superior design and engineering power the Aurora's unparalleled performance. With many of the same features as its sister Echelon Diamond Series, the Aurora grill delivers cooking versatility, durability, and longevity in a beautifully crafted machine.

# AURORA

S E R I E S

## FEATURE HIGHLIGHTS



Analog Thermometer



Interior Halogen Lights  
*(Angled Lights on A790 & A660 units)*

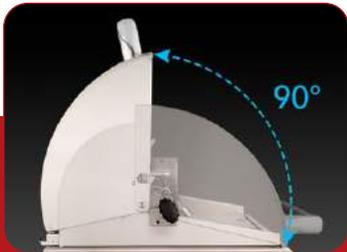

Seamless, 90° hood w/ Spring Assist



Dual Position Warming Rack



Diamond Sear Cooking Grids



Optional Backburner & Rotisserie Kit



Heavy Duty Flavor Grids  
*(Zone Flavor Grids on A790 & A660 units)*



Cast Stainless Steel Burners



Hot Surface Ignition



Contoured Face w/ Back-Lit Knobs



### Diamond Sear Cooking Grills\*

All 304 stainless steel cooking grids provide more optimal cooking surface for even heat and great searing.

\*U.S. Patent No.: D857,453 & D862,984

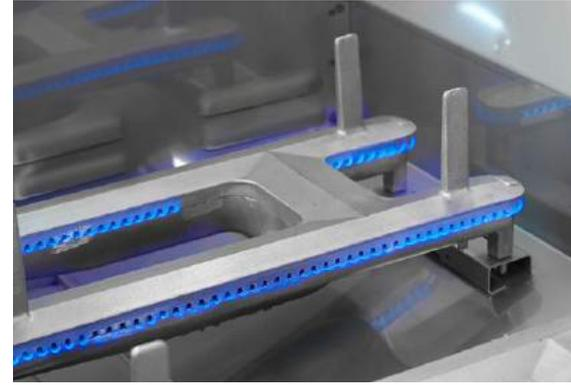

### Cast Stainless Steel Burners

1/4" thick cast stainless steel "E" burners for consistent, even heat and a lifetime of durability.



### Flavor Grids †

16-gauge stainless steel flavor grids are engineered for durability, even heat distribution, and reduced flare-ups.

†Zone Flavor Grids on A790 & A660 units



### Analog Thermometer With Angled Bezel

Analog thermometer with an angled bezel for ease of reading the temperature (up to 1000°).



### Halogen Interior Lights\*\*

12 Volt interior halogen lights make evening grilling a breeze.

\*\* Angled lights on A790 & A660 units



### Hot Surface Ignition

Hot surface electronic ignition provides reliable lighting for every meal. Requires 120 Volt AC power.



### Back-Lit Comfort Touch Knobs

Back-lit knobs (at 41°) with comfort touch grips and flame icons for convenience.



### Optional Magic View Window

Optional Magic View Window available on Aurora A790 and A660 grills. Thermometer with handsome angled bezel in hood.

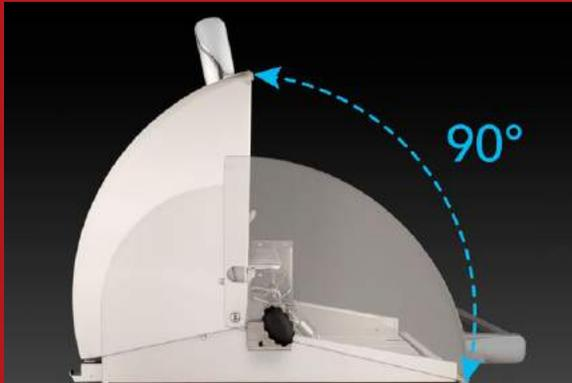

### 90 Degree Hood

Allows easy access to grilling and more efficient exhaust.



### Optional Backburner & Rotisserie Kit

Optional premium backburner and a complete rotisserie kit with heavy duty motor and a polished stainless steel cover.



### Adjustable, Dual Position Warming Rack

Dual position stainless steel warming rack for easier use and storage.

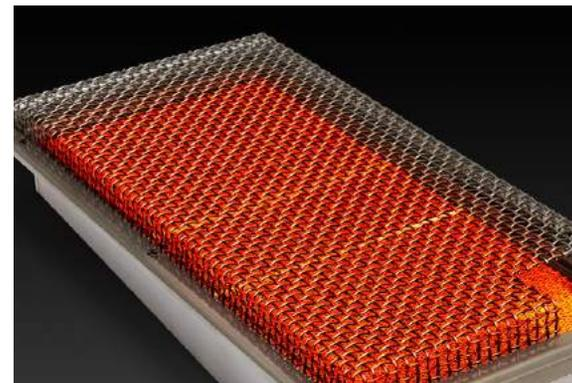

### Optional Infrared Burner

Optional infrared sear burner in the left hand position locks in juices for tender meat and full flavor. Available on all Aurora grills.



Optional Magic View Window

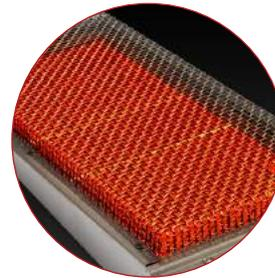

Optional Infrared Burner on the left side

## Aurora A790i, 36" Built-In Grill

A790i-8EAN\*-W (optional Magic View Window, Backburner and Rotisserie Kit shown)

### KEY FEATURES

- Heavy duty **Diamond Sear** cooking grids
- Cast stainless steel "E" burners
- Heavy gauge stainless steel dual position, adjustable warming rack
- Heavy gauge all stainless steel **Zone Flavor Grids**
- Push-to-light **Hot Surface Electric Ignition** system with flash tubes
- Halogen 12 Volt internal oven lamps
- Gourmet control panel with brushed trim and polished, back-lit knobs
- Angled, analog thermometer in lid measuring up to 1000° F
- Seamless double wall 90° hood with feather-lite easy lift lid
- Optional premium backburner and rotisserie kit

### KEY FEATURES (continued)

- Optional infrared sear burner
- Optional **Magic View Window** in lid for A79 & A66

### SPECIFICATIONS

- Primary cooking surface: **36" x 22" (792 sq. in.)**
- Warming rack surface: **36" x 8" (288 sq. in.)**
- Main burners: **90,000 BTU's**
- Backburner (if equipped): **13,000 BTU's**
- Cut-out dimensions: **37" w x 23½" d x 11½" h**



A790i-8EAN  
w/ Backburner & Rotisserie Kit



A790i-8EAN-W  
w/ Magic View Window, Backburner & Rotisserie Kit



A790i-7EAN



A790i-7EAN-W  
w/ Magic View Window

\*All models available in natural gas or propane (for propane, change **N** to **P** in the model number).

## Aurora A660i, 30" Built-In Grill

A660i-8EAN\* (optional Backburner and Rotisserie Kit shown)

- Primary cooking surface: **30" x 22"** (660 sq. in.)
- Warming rack surface: **30" x 8"** (240 sq. in.)
- Main burners: **75,000 BTU's**
- Backburner (if equipped): **11,000 BTU's**
- Cut-out dimensions: **31¼" w x 23½" d x 11½" h**



## Aurora A660s, 30" Portable Grill

A660s-8EAN\*-62

(optional Magic View Window, Backburner and Rotisserie Kit shown)

- Primary cooking surface: **30" x 22"** (660 sq. in.)
- Warming rack surface: **30" x 8"** (240 sq. in.)
- Main burners: **75,000 BTU's**
- Backburner (if equipped): **11,000 BTU's**
- Side Burner: **15,000 BTU's**



\*All models available in natural gas or propane (for propane, change N to P in the model number).



Optional Magic View Window with integrated Analog Thermometer



Optional Backburner and Heavy Duty Rotisserie Kit

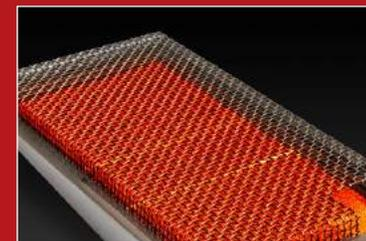

Optional Infrared Burner



Flush Mounted Side Burner

## Aurora A540i, 30" Built-In Grill

A540i-8EAN\* (optional Backburner and Rotisserie Kit shown)

- Primary cooking surface: **30" x 18" (540 sq. in.)**
- Warming rack surface: **30" x 8" (240 sq. in.)**
- Main burners: **63,000 BTU's**
- Backburner (if equipped): **11,000 BTU's**
- Cut-out dimensions: **32" w x 19½" d x 11½" h**



Optional Backburner and Heavy Duty Rotisserie Kit

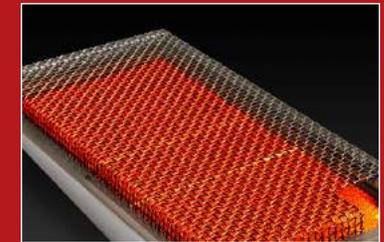

Optional Infrared Burner

## Aurora A540s, 30" Portable Grill

A540s-8EAN\*-62 (optional Backburner and Rotisserie Kit shown)

- Primary cooking surface: **30" x 18" (540 sq. in.)**
- Warming rack surface: **30" x 8" (240 sq. in.)**
- Main burners: **63,000 BTU's**
- Backburner (if equipped): **11,000 BTU's**
- Side Burner: **15,000 BTU's**



Flush Mounted Side Burner

\*All models available in natural gas or propane (for propane, change **N** to **P** in the model number).

## Aurora A430i, 24" Built-In Grill

A430i-8EAN\* (optional Backburner and Rotisserie Kit shown)

- Primary cooking surface: **24" x 18" (432 sq. in.)**
- Warming rack surface: **24" x 8" (192 sq. in.)**
- Main burners: **50,000 BTU's**
- Backburner (if equipped): **11,000 BTU's**
- Cut-out dimensions: **25½" w x 19½" d x 11½" h**



Optional Backburner and Heavy Duty Rotisserie Kit

## Aurora A430s, 24" Portable Grill

A430s-8EAN\*-62 (optional Backburner and Rotisserie Kit shown)

- Primary cooking surface: **24" x 18" (432 sq. in.)**
- Warming rack surface: **24" x 8" (192 sq. in.)**
- Main burners: **50,000 BTU's**
- Backburner (if equipped): **11,000 BTU's**
- Side Burner: **15,000 BTU's**

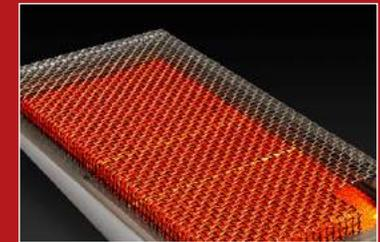

Optional Infrared Burner



Flush Mounted Side Burner

\*All models available in natural gas or propane (for propane, change **N** to **P** in the model number).



## Aurora A830i Gas/Charcoal Combo Built-In

A830i-8EAN\*-CB (optional Backburner and Rotisserie Kit shown)

### KEY FEATURES

- Halogen Lights and Backburner for the A830i model are located on the gas side of the grill only.

### SPECIFICATIONS

- Primary Cooking Surface: Gas Side 24" x 18" = (828 sq. in.)  
Charcoal Side 22" x 18" = (396 sq. in.)
- Warming Rack Surface: Gas Side 24" x 8" = (192 sq. in.)  
Charcoal Side 22" x 8" = (176 sq. in.)
- Main Burners: **50,000 BTU's**
- Backburner (if equipped): **11,000 BTU's**
- Charcoal Igniter: **26,000 BTU's**
- Cut-out Dimensions: **50¼" w x 19½" d x 11½" h**

\*All models available in natural gas or propane (for propane, change **N** to **P** in the model number).

# AURORA

S E R I E S



Optional Backburner and Heavy Duty Rotisserie Kit on the Gas Side



Charcoal/Wood Feed Door with Adjustable Pan



Charcoal Igniter (26,000 BTU's)



Ash Catch



## Aurora A830s Gas/Charcoal Combo Portable

A830s-8EAN\*-61-CB (optional Backburner and Rotisserie Kit shown)

### KEY FEATURES

- Halogen Lights and Backburner for the A830s model are located on the gas side of the grill only.

### SPECIFICATIONS

- Primary Cooking Surface: Gas Side 24" x 18" = (828 sq. in.)  
Charcoal Side 22" x 18" = (396 sq. in.)
- Warming Rack Surface: Gas Side 24" x 8" = (192 sq. in.)  
Charcoal Side 22" x 8" = (176 sq. in.)
- Main Burners: **50,000 BTU's**
- Backburner (if equipped): **11,000 BTU's**
- Charcoal Igniter: **26,000 BTU's**

\*All models available in natural gas or propane (for propane, change N to P in the model number).

# AURORA

S E R I E S

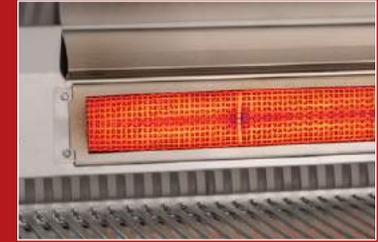

Optional Backburner and Heavy Duty Rotisserie Kit on the Gas Side



Charcoal/Wood Feed Door with Adjustable Pan



Charcoal Igniter (26,000 BTU's)



Ash Catch



Our most affordable line, Fire Magic® Choice grills feature superior design and materials housed in an Aurora style grill with a simple satin stainless steel façade.

# CHOICE

S E R I E S



Angled Analog Thermometer



Diamond Sear Cooking Grids

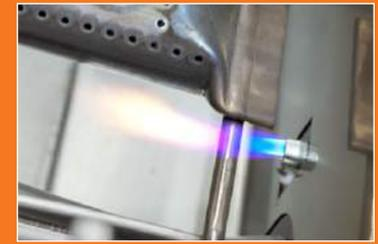

Turn-to-Light Ignition System



14 Gauge, U-Shaped S.S. Burners

## Choice C650i, 36" Built-In Grill

C650i-RTIN\*

### KEY FEATURES

- Heavy duty **Diamond Sear** cooking grids
- 14 Gauge, stainless steel U-shaped burners
- Heavy gauge stainless steel dual position, adjustable warming rack
- Heavy gauge all stainless steel **Flavor Grids**
- **Turn-to-Light Ignition System** (no power or batteries required)
- Angled, analog thermometer in lid measuring up to 1000° F
- Seamless, double wall 90° Hood

### SPECIFICATIONS

- Primary cooking surface: **36" x 18"** (648 sq. in.)
- Warming rack surface: **36" x 8"** (288 sq. in.)
- Main burners: **69,000 BTU's**
- Cut-out dimensions: **37¾" w x 19½" d x 11½" h**



\*All models available in natural gas or propane (for propane, change **N** to **P** in the model number).

Choice Series | Built-In and Post Mount Grills

# CHOICE

S E R I E S



**Choice C540i, 30" Built-In Grill**  
C540i-RTIN\*

- Primary cooking surface: **30" x 18"** (540 sq. in.)
- Warming rack surface: **30" x 8"** (240 sq. in.)
- Main burners: **60,000 BTU's**
- Cut-out dimensions: **32" w x 19½" d x 11½" h**



**Choice C430i, 24" Built-In Grill**  
C430i-RTIN\*

- Primary cooking surface: **24" x 18"** (432 sq. in.)
- Warming rack surface: **24" x 8"** (192 sq. in.)
- Main burners: **46,000 BTU's**
- Cut-out dimensions: **25½" w x 19½" d x 11½" h**

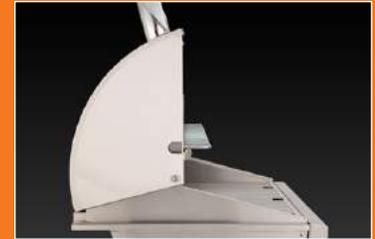

Seamless, 90° Hood



Adjustable, Dual Position Warming Rack



Heavy Gauge Flavor Grids



1-Hour Automatic Timer on Post Units



**Choice C430s, 24" Patio Post Mount Grill**  
C430s-RTIN\*-P6

- Primary cooking surface: **24" x 18"** (432 sq. in.)
- Warming rack surface: **24" x 8"** (192 sq. in.)
- Main burners: **46,000 BTU's**



**Choice C430s, 24" In-Ground Post Mount Grill**  
C430s-RTIN\*-G6

- Primary cooking surface: **24" x 18"** (432 sq. in.)
- Warming rack surface: **24" x 8"** (192 sq. in.)
- Main burners: **46,000 BTU's**



## Regal I Drop-In Grill

34-S2S1N\*-A (with Backburner & Rotisserie shown)

- Primary cooking surface: **30" x 18" (540 sq. in.)**
- Warming rack surface: **30" x 8" (240 sq. in.)**
- Main burners: **66,000 BTU's**
- Backburner (if equipped): **22,000 BTU's**
- Cut-out dimensions: **41½" w x 20½" d x 18" h**
- Features patented Diamond Sear cooking grids.
- Available without rotisserie and backburner; Model #: **34-S1S1N\*-A**



## LEGACY

Collection

The uniquely-designed, exclusive Drop-In grill brings a simple, streamlined style to your outdoor kitchen

## Deluxe Gourmet Drop-In Grill

3C-S1S1N\*-A

- Primary cooking surface: **23" x 16" (368 sq. in.)**
- Warming rack surface: **23" x 8" (184 sq. in.)**
- Main burners: **42,000 BTU's**
- Cut-out dimensions: **29½" w x 16½" d x 14" h**



## Deluxe Classic Drop-In Grill

31-S1S1N\*-A

- Primary cooking surface: **23" x 16" (368 sq. in.)**
- Warming rack surface: **23" x 8" (184 sq. in.)**
- Main burners: **42,000 BTU's**
- Cut-out dimensions: **24½" w x 19¼" d x 12" h**



## Deluxe Built-In Grill

11-S1S1N\*-A

- Primary cooking surface: **23" x 16" (368 sq. in.)**
- Main burners: **42,000 BTU's**
- Cut-out dimensions: **24¾" w x 17¾" d x 12" h**



\*All models available in natural gas or propane (for propane, change **N** to **P** in the model number).

# LEGACY

Collection



## Drop-In Grills

The Fire Magic® Legacy Drop-In grills are an exclusively designed, space conscious unit for a unique look. Only Fire Magic® offers the Drop-In grill to enhance your outdoor kitchen.



## Cast Stainless Steel Burners

Cast stainless steel burners offer a classic durability that Fire Magic® is known for.



# CHARCOAL

## Grills

High performance charcoal grills are available in a variety of models including Built-In, Post Mount, and Drop-In. Fire Magic® delivers quality and style to the charcoal grill enthusiast.

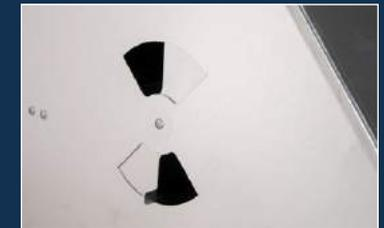

### Adjustable Hood Vents

Stainless Steel Charcoal Grills feature a smoker hood with adjustable hood vents to regulate airflow.



### Integrated Warming Rack

Movable warming rack that adds a second level for optimum smoking performance. Stays horizontal (when opened or closed) for dual level smoking.



### Front Door for Effortless Loading

## 30" S.S. Charcoal Built-In Grill (14-SC01C-A shown)

- Primary cooking surface: **30" x 18" (540 sq. in.)**
- Warming Rack surface: **30" x 12" (360 sq. in.)**
- Cut-out dimensions: **32¼" w x 19¾" d x 12" h**

## 24" S.S. Charcoal Built-In Grill (12-SC01C-A)

- Primary cooking surface: **24" x 18" (432 sq. in.)**
- Warming Rack surface: **24" x 12" (288 sq. in.)**
- Cut-out dimensions: **26¼" w x 19¾" d x 12" h**



## Charcoal Grills

### 24" S.S. Charcoal Patio Post Mount Grill (22-SC01C-P6 shown)

- Primary cooking surface: **24" x 18" (432 sq. in.)**
- Warming Rack surface: **24" x 12" (288 sq. in.)**
- All 304 stainless steel post and stand.
- Stainless steel pedestal to bolt onto surface.

### 24" S.S. Charcoal In-Ground Post Mount Grill (22-SC01C-G6)

- Primary cooking surface: **24" x 18" (432 sq. in.)**
- Warming Rack surface: **24" x 12" (288 sq. in.)**
- All 304 stainless steel post.



### 31" Firemaster Drop-In Grill (3324\* shown)

- Cooking surface: **30" x 18" (540 sq. in.)**
- Cut-out dimensions: **31¼" w x 21¼" d x 12" h**

### 24" Firemaster Drop-In Grill (3329\*)

- Cooking surface: **23" x 16" (368 sq. in.)**
- Cut-out dimensions: **24¼" w x 19¼" d x 12" h**

- *Designed to drop into the top of your island.*
- *Cooking grids must be ordered separately.*



### 32" Lift-A-Fire Built-In Grill (3334\* shown)

- Cooking surface: **30" x 18" (540 sq. in.)**
- Cut-out dimensions: **32¼" w x 19¼" d x 12" h**

### 24" Lift-A-Fire Built-In Grill (3339\*)

- Cooking surface: **23" x 16" (368 sq. in.)**
- Cut-out dimensions: **24¼" w x 17¼" d x 12" h**

- *Cooking grids must be ordered separately.*



\*Cooking grids and ovens (if desired) for Firemaster & Lift-A-Fire Slide-In must be ordered separately.

# CHARCOAL Grills



### Adjustable Charcoal Pan(s)

All charcoal grills feature a crank handle that allows you to adjust the height of the charcoal pan.

## Electric Grills

### ELECTRIC GRILLS

The Fire Magic® Electric Grill provides quick, clean, and easy grilling. Great for patios with limited space, or where gas fuel is unavailable.

#### FEATURE HIGHLIGHTS

- All 304 stainless steel construction
- 252 sq. inches of grilling space
- 120 Volt. Just plug in and use
- 20 AMP minimum required
- Over 100 inches of heating element
- Double walled oven lid
- Substantial (largest, thickest) heating element for faster, hotter cooking
- Optional rotisserie kit upgrade
- Heats up to 800° F (1680 watt grill)
- Stainless steel cooking grids
- Digital thermometer with thermostatic control and meat probe for precision grilling
- Easy to clean drip tray
- Removable warming rack

### Electric Table Top Grill

E251t-1Z1E (shown)

- Cooking Surface: **15½" x 16¼" (252 sq. in.)**
- Warming Rack Surface: **16" x 4" (64 sq. in.)**
- Power Required: **120 Volt**



### Electric Built-In Grill

E251i-1Z1E

- Cut-out Dimensions: **17¾" w x 17½" d x 7¾" h**
- For use with field constructed grill islands

### Electric Patio Post Mount Grill

E251s-1Z1E-P6

- Cooking Surface: **15½" x 16¼" (252 sq. in.)**
- Warming Rack Surface: **16" x 4" (64 sq. in.)**
- Power Required: **120 Volt**
- Folding side shelves for easy storage.
- All 304 stainless steel post and stand.



### Electric Grill Island Bundle with Triple Drawer \*

ID251-D-44SM

- Dimensions: **44" w x 24" d x 36" h**
- Components included in the bundle:
  - GFRC Island in Smoke finish
  - E251i-1Z1E-DC - Electric Built-In Grill
  - 53803SC - Triple Drawer
  - L.E.D. lights at the bottom of the island



### Electric Grill Island Bundle with Refrigerator \*

ID251-R-44SM

- Dimensions: **44" w x 24" d x 36" h**
- Components included in the bundle:
  - GFRC Island in Smoke finish
  - E251i-1Z1E-DC - Electric Built-In Grill
  - 3598-DR - Refrigerator
  - 53802SC - Double Drawer
  - L.E.D. lights at the bottom of the island



\*The Electric Island Bundles are sold only as a complete package with the products listed. The Bundles require two dedicated GFCI circuits and outlets, one 20 amp circuit for the electric grill and one 15 amp circuit for refrigerator and led lighting. Or one 30 amp dedicated GFCI circuit can handle the power requirements for the entire island.

## Echelon Gourmet Griddle

### GOURMET GRIDDLE

Fire Magic's new **Gourmet Griddle** is perfect for outdoor cooking of everything from fried rice and fajitas to bacon and eggs. Take outdoor cooking to a new level with the Echelon E660i(s) Gourmet Griddle.

#### FEATURE HIGHLIGHTS

- All 304 stainless steel construction
- Expansive 30" x 18" cooking area
- **3/8" thick** stainless steel griddle surface for years of warp-free performance
- Dual heavy duty stainless steel burners combining to provide up to 45,000 BTU's
- Hot surface ignition and two back-lit control knobs to provide two-zone cooking
- Two-piece drip collector trough over two ports that funnel the excess grease to the drip pan below
- Built-in model has same cut-out dimensions as E660i grill
- Stainless steel cover protects griddle when not in use
- Handles on stainless steel cover for ease of removal and replacement



### Echelon Gourmet Built-In Griddle

E660i-OT4N\*

- Cooking Surface: **30" x 18" (540 sq. in.)**
- Main Burners: **45,000 BTU's**
- Cut-out Dimensions: **31¼" w x 23½" d x 11½" h**

\*All models available in Natural Gas or Propane (for Propane, change **N** to **P** in the model number).



### Echelon Gourmet Portable Griddle

E660s-OT4N\*-61

- Cooking Surface: **30" x 18" (540 sq. in.)**
- Main Burners: **45,000 BTU's**



#### 3/8" Thick Griddle Surface

3/8" thick stainless steel griddle surface for years of warp-free performance.



#### U-Shaped S.S. Burners

14-gauge stainless steel burners for durability and even heat.

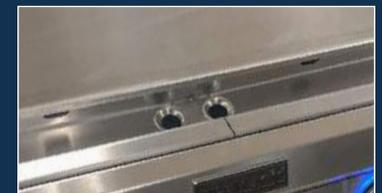

#### Drip Collector Trough

Two-piece drip collector trough over two ports that funnel the excess grease to the drip pan below.



# SIDE COOKERS

Power Burners, Side Burners, and Searing Stations

Fire Magic® Power Burners, Side Burners, and Searing Stations are designed as companion cookers to Fire Magic grills. All side cookers feature a matching face for either Echelon Diamond or Aurora models, as well as back-lit control knobs, hot-surface ignition, and a power switch. All Echelon accessories plug in to the Echelon Diamond Grill transformer for power and Aurora accessories plug into the Aurora transformer.

## Power Burners Feature Highlights

- Outstanding side cooker provides versatility in cooking.
- Up to 60,000 BTU's of cooking power, knob on left for inner burner has a range of 3,000-15,000 BTU's. Larger knob on right for outer burner has a maximum of 45,000 BTU's.
- Back-lit control knobs for added aesthetics and visibility.
- The **10" diameter, Heat Concentrating Flame Collimator** focuses heat in the center 25% of unit (for wok cooking, turkey frying or any other dish needing up to 190 BTU/sq. in. of heat).
- Power switch for easy operation.
- Power Burner Plugs in to the Echelon Diamond or Aurora Grill transformer for power.



### Echelon Power Burner

**19-5B1N\*-0** (w/ Stainless Steel Grid)  
**19-5B2N\*-0** (w/ Porcelain Cast Iron Grid, shown)

- Burners: **60,000 BTU's**
- Cut-out: **19" w x 18 3/4" d x 11 1/2" h**
- The Echelon Power Burner is the largest, most powerful side cooker available and provides the high heat that's perfect for wok cooking or frying a turkey! Offering a range of 3,000 to 60,000 BTU's.



### Aurora Power Burner

**19-7B1N\*-0** (w/ Stainless Grid, shown)  
**19-7B2N\*-0** (w/ Porcelain Cast Iron Grid)

- Burners: **60,000 BTU's**
- Cut-out: **19" w x 18 3/4" d x 11 1/2" h**
- The Aurora Power Burner is the largest, most powerful side cooker available. It provides a range of BTU's from 3,000 to 60,000. Available with porcelain cast iron or stainless steel grids.

\*Fire Magic® Power Burners include removable stainless steel lid and are available in Natural Gas or Propane (for Propane, change **N** to **P** in the model number).

# POWER BURNERS



### 10" Flame Collimator

The 10" dia. Heat Concentrating Flame Collimator focuses heat in the center 25% of unit (for wok cooking, turkey frying or any other dish needing up to 190 BTU/sq. in. of heat).



### Double Cast Brass Burner

Up to 60,000 BTU's of cooking power; Inner burner has a range of 3,000-15,000 BTU's, larger outer burner has a maximum of 45,000 BTU's.



### S.S. Griddle Adapter (#3683)

New Griddle Adapter allows you to use both sizes of Stainless Steel Griddles on your Fire Magic® Power Burner. (sold separately)

### Echelon Double Side Burner

32815

- Burners: **30,000 BTU's (15,000 x 2)**
- Cut-out: **11½" w x 22¾" d x 11½" h**
- Enjoy precise flame control on each burner to prepare side dishes and sauces for your meal (Two [2] 15,000 BTU's burners).



### Aurora Double Side Burner

32817

- Burners: **30,000 BTU's (15,000 x 2)**
- Cut-out: **11½" w x 22¾" d x 11½" h**
- The Double side burner offers precise flame control on each burner to prepare side dishes and sauces for your meal (Two [2] 15,000 BTU's burners).



### Choice Double Side Burner

3281R

- Burners: **30,000 BTU's (15,000 x 2)**
- Cut-out: **11½" w x 22¾" d x 11½" h**
- The Double side burner offers precise flame control on each burner to prepare side dishes and sauces for your meal (Two [2] 15,000 BTU's burners).



### Echelon Single Side Burner

32795-1

- Burner: **15,000 BTU's**
- Cut-out: **11½" w x 14" d x 11½" h**
- The Echelon Single Side Burner features a 15,000 BTU's burner, precise flame control valve, and stainless steel cover.



### Aurora Single Side Burner

32797-1

- Burner: **15,000 BTU's**
- Cut-out: **11½" w x 14" d x 11½" h**
- Features of this single side burner include a 15,000 BTU's burner, and precise flame control valve.



### Choice Single Side Burner

3279R-1

- Burner: **15,000 BTU's**
- Cut-out: **11½" w x 14" d x 11½" h**
- Features of this single side burner include a 15,000 BTU's burner, and precise flame control valve.



### Drop-In Side Burner

3280

- Burner: **15,000 BTU's**
- Cut-out: **8¾" w x 14¼" d**
- Drops into the top of island. Features include 15,000 BTU's sealed burner, precise flame control valve, and stainless steel cover.



All Fire Magic® Side Burners include removable stainless steel lid and are available in models available in natural gas or propane.

### Echelon Double Searing Station

32885-1

- Burners: **32,000 BTU's**
- Cut-out: **19" w x 18¾" d x 11½" h**
- With the Echelon Double Searing Station, prepare restaurant-quality steaks. When steaks are flash-cooked up to 1200° using infrared technology plus Diamond Sear cooking grids, juices are locked in and meats are tender and full of flavor.



### Echelon Searing Station

32875-1

- Burner: **20,000 BTU's**
- Cut-out: **14" w x 22¾" d x 11½" h**
- Sear favorites such as ahi tuna and marbled fillet mignon to perfection with 24,000 BTU's and up to 1000° of infrared heat. Perfect for an amazing seared steak. Includes the new Diamond Sear cooking grids.



### Aurora Double Searing Station

32887-1

- Burners: **32,000 BTU's**
- Cut-out: **19" w x 18¾" d x 11½" h**
- With the Aurora Double Searing Station steaks are flash-cooked at 1200°, juices are locked in and meats are tender and full of flavor. With 32,000 BTU's of infrared heat and Diamond Sear cooking grids, the double searing station is a welcome companion to your Fire Magic® grill.



### Aurora Searing Station

32877-1

- Burner: **20,000 BTU's**
- Cut-out: **14" w x 22¾" d x 11½" h**
- This single searing station flash cooks up to 24,000 BTU's and up to 1000° of infrared heat locking in juices for tender meat and full flavor upon Diamond Sear cooking grids. Perfect for an amazing seared steak.



### Classic Double Searing Station

3288K-1 (w/ Battery Ignition)

- Burners: **32,000 BTU's**
- Cut-out: **19" w x 18¾" d x 11½" h**
- With the Double Searing Station steaks are flash-cooked at 1200°, juices are locked in and meats are tender and full of flavor. With 32,000 BTU's of infrared heat and Diamond Sear cooking grids, the double searing station is a welcome companion to your Fire Magic® grill.



### Classic Searing Station

3287K-1 (w/ Battery Ignition)

- Burner: **20,000 BTU's**
- Cut-out: **14" w x 22¾" d x 11½" h**
- This single searing station flash cooks up to 24,000 BTU's and up to 1000° of infrared heat locking in juices for tender meat and full flavor upon Diamond Sear cooking grids. Perfect for an amazing seared steak.





# REFRIGERATION

PRODUCTS

and

# REFRESHMENT

CENTERS



### Outdoor Rated Refrigerator

**3589-DR** (Model w/ right door hinge, shown)

**3589-DL** (Model w/ left door hinge)

- Cut-out Dimensions: **35" h x 24½" w x 25" d**
- 5.1 cubic feet of storage
- Internal digital thermometer
- Adjustable shelves
- LED internal light
- Lock and key
- Fire Magic® style handle
- Extra storage space available in the door
- UL listed for outdoor use



### Outdoor Rated Kegerator

**3594-DR** (Model w/right door hinge)

**3594-DL** (Model w/left door hinge, shown)

- Cut-out Dimensions: **35" h x 24½" w x 25" d**
- Double tap kegerator
- Internal digital thermometer
- Closed door assist with lock and key system ensures your beverages will stay cold and secure
- Can accommodate a full, half, quarter or one-sixth sized kegs
- Metal shelves included to convert to a full refrigerator when not storing a keg
- UL listed for outdoor use



## REFRIGERATION PRODUCTS



### Lock and Key

Lock and key to ensure beverages will stay cold and secure.



### Digital Thermometer

Internal digital thermometer to maintain proper temperature for your beverages.



Kegerator accommodates a full, half, quarter or one-sixth sized kegs.

# REFRIGERATION PRODUCTS



## AUTOMATIC OUTDOOR ICE MAKER



Stores up to 27 lbs of ice



Produces clear, bell-shaped ice cubes

## Refrigeration Products | Refrigerators & Ice Maker



### Refrigerator

3598

- Cut-out Dimensions: **20" w x 21¼" d x 34¾" h**
- Interior light and security lock and key.
- Reversible door hinge.
- When used outdoors, it must be installed in an enclosure.



### Premium Refrigerator

3598-DR (Model w/right door hinge, shown)

3598-DL (Model w/left door hinge)

- Cut-out Dimensions: **20" w x 21¼" d x 34¾" h**
- 4.0 cubic feet of storage space.
- Custom-designed door is fabricated with a heavy-duty handle and square edges to match doors, drawers, and other accessories.
- Handy lock keeps contents safe.
- When used outdoors, it must be installed in an enclosure.

### Automatic Outdoor Ice Maker

5597

- Minimum Cut-out Dimensions: **15¼" w x 25¼" d x 34" h**
- Outdoor rated ice maker produces 63 lbs of ice in a 24 hour period.
- Capable of storing up to 27 lbs of individual clear, bell-shaped ice cubes.
- UL listed for outdoor use.
- Continuously produces ice on demand as ice used.
- Suitable for outdoor or indoor applications.
- Reversible door features horizontal handle that doubles as a Towel Bar.

DESCRIPTION	SPECIFICATIONS
Unit Dimensions (door closed)	15" w x 25¼" d x 34" - 35" h*
Rated Power	120V / 9A Max / 60Hz
Power	Max 500W
Net Weight	110 lbs
Gross Weight	140 lbs
Ice Production	63 lbs per 24 hours**
Ice Storage	up to 27 lbs

\* Height may be adjusted from 34" to 35". Depth includes door and handle.

\*\* Actual quantity of ice produced can vary with conditions.



Horizontal handle that doubles as a towel bar (towel included)



Ice Scoop Included

## Beverage and Refreshment Centers



### Refreshment Center

3596A

- Cut-out dimensions: **25" w x 25" d x 12" h**
- Insulated walls, bottom drain, in-front shelving, attached bottle opener, included drain kit, Echelon styled face and hinged removable lid.



### Drop-In Refreshment Center

33596

- Cut-out dimensions: **25" w x 23<sup>3</sup>/<sub>8</sub>" d x 12<sup>3</sup>/<sub>4</sub>" h**
- Use like an ice cooler in your grill island to keep soda, beer or other beverages cold and frosty. Includes handy drain kit and hinged removable insulated lid.



### Beverage Butler

3835

- Cut-out dimensions: **32<sup>1</sup>/<sub>2</sub>" w x 20" d x 12" h \***
- Stainless Steel Construction including SS Sink and Mixer Faucet, Insulated Ice Chest with removable lid, Front Beverage Caddy with Towel Rack, Bottle Opener, removable Cutting Board, and Condiment Trays.

\*An additional cutout is required for the faucet, refer to the owner's manual for complete specifications and requirements.



### Bar Caddy

1D-S0

- Cut-out dimensions: **14" w x 22<sup>3</sup>/<sub>4</sub>" d x 12" h**
- Bar Caddy comes equipped with a towel bar, bottle opener, sliding storage drawer, two stainless steel bottle sleeves and an installation hanger.
- Available with the optional steam warming accessory.

## BEVERAGE BUTLER

### KEY FEATURES



Stainless Steel Mixer Faucet



Removable Bamboo Cutting Board



Removable Condiment Trays



Towel Rack & Bottle Opener

# ISLAND SYSTEMS

## GLASS FIBER REINFORCED CONCRETE ISLAND SYSTEMS

Constructed from durable Glass Fiber Reinforced Concrete (GFRC) and easily assembled on site, these Island Systems are designed specifically for Fire Magic® equipment and make a stunning statement in any backyard.

Models include islands with Café Blanco island bases and contrasting polished GFRC Smoke counter tops as well as the "Reclaimed Wood" series.



### DL660 L-Shape "Reclaimed Wood" Island Systems

L-Shape islands feature a "Reclaimed Wood" style French Barrel Oak (FO) or new weathered look Silver Pine (SP) base finishes with Polished Black Lava counter tops. The elevated corner section is perfect for seating and has a hole for a locally sourced umbrella. Showcasing an E660i Echelon grill, there are three choices of accessories for the return side (Kegerator, Refrigerator, or Medium Pantry Drawer). All versions include an additional storage door access on the outside and a metal shelf behind the double doors to keep items off the ground.

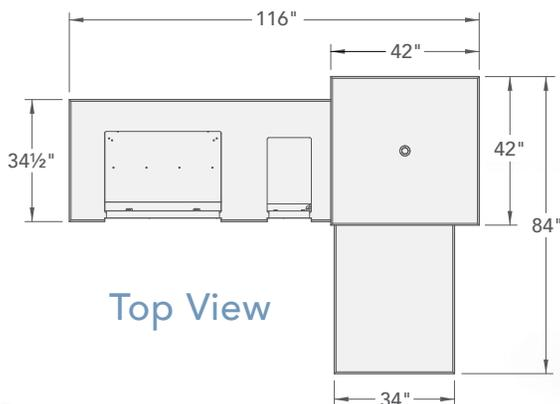

### DL660 L-Shape "Reclaimed Wood" Island Systems

Dimensions: 116" w x 84" d x 42 1/2" h

MODEL #	RETURN SIDE ACCESSORY	BASE COLOR
IL660-FOK-116BA	Kegerator (shown)	French Barrel Oak (FO)
IL660-FOR-116BA	Refrigerator	
IL660-FOD-116BA	Medium Pantry	
IL660-SPK-116BA	Kegerator	Silver Pine (SP)
IL660-SPR-116BA	Refrigerator	
IL660-SPD-116BA	Medium Pantry	



Additional Access Door on the outside.

#### Required Components (sold separately):

- E660i or A660i - 30" Built-in grill
- 32815 or 32817 - Built-in double side burner
- 53802SC - Double drawer
- 53934SC - Double door
- 53920SC-R (-L) - Single access door
- 53820SC-TL (-TR) - Single access door w/ tank tray & louvers // or 53920SC-R (-L) - Single access door // or 53820TSC - Trash Cabinet
- 5520-11T (1-hr) or 5520-13T (3-hr) - S. S. Timer Box

#### Plus your choice of:

- 3594-DR (-DL) - Outdoor Kegerator
- 3589-DR (-DL) - Outdoor Refrigerator
- 54018S - Medium Pantry Drawer

## Island Systems



Model #: ID660-SPD-77BA



Model #: ID790-CBR-108SM



Model #: ID660-FOD-77BA



Model #: ID790-CBD-108SM

### 77" Reclaimed Wood Island Systems

Dimensions: 77" w x 34½" d x 36½" h

MODEL #	ISLAND DESCRIPTION
ID660-FOD-77BA	w/ French Barrel Oak (FO) base
ID660-SPD-77BA	w/ Silver Pine (SP) base

**Required Components** (sold separately):

- E660i or A660i - 30" Built-in grill // or E660i Gourmet Griddle
- 32815 or 32817 - Built-in double side burner
- 53802SC - Double drawer
- 53934SC - Double door
- 53820SC-TL (-TR) - Single access door w/ tank tray & louvers // or 53920SC-R (-L) - Single access door // or 53820TSC - Trash Cabinet
- 5520-11T (1-hr) or 5520-13T (3-hr) - Stainless Steel Timer Box

### ID790 GFRC Island Systems

Dimensions: 107½" w x 34¾" d x 36" h

MODEL #	ISLAND DESCRIPTION
ID790-CBR-108SM	w/ Refrigerator
ID790-CBD-108SM	w/ Double Drawer

**Required Components** (sold separately):

- E790i or A790i - 36" Built-in grill
- 32815 or 32817 - Built-In double side burner
- 3598-DR (-DL) - Refrigerator (for ID790-CBR-108SM)
- 53802SC or 33802 - Double drawer (for ID790-CBD-108SM)
- 53938SC or 33938S - Reduced height double door
- 53820SC-TL (-TR) or 33820-TSL (-TSR) - Single access door w/ tank tray & louvers // or 53920SC-R (-L) or 33920-SR (-SL) - Single access door // or 53820TSC - Trash Cabinet
- 5520-11T (1-hr) or 5520-13T (3-hr) - Stainless Steel Timer Box

# PREMIUM ACCESSORIES



## Premium Accessories

### Pizza Stone Kit

3514

- 16¼" x 16¼" stainless steel frame
- 14" x 14" x 5/8" durable cordierite\* baking stone
- 12" x 19" wooden pizza peel
- The Pizza Stone Kit includes everything you need to make artisan style pizzas on Echelon and Aurora Fire Magic® gas grills.
- Better control of heat for optimal results.
- 3-year warranty.



\* **Cordierite pizza stones** are extremely durable and are built to outlast all others. Cordierite is a mineral known for its ability to handle extreme temperatures well. It's thermal shock resistant, you can take a cordierite stone from a low temperature to a very high temperature without the risk of breaking it. These stones can literally handle all the heat your grill can dish out and still keep cranking out pizzas year after year.

### STAINLESS STEEL FAUCET & DOUBLE SINK

The new **Stainless Steel Mixer Faucet** and under-mount **Double Sink** may be used together to complement and enhance any outdoor kitchen conception...modern or traditional.



### Stainless Steel Mixer Faucet

3836

- Stainless steel construction with hot and cold capabilities.



### Double Sink

3837

- Stainless steel construction under-mount double sink (30" x 16") with a drain plug on each side.

## Premium Accessories

### Sink & Faucet

3587 & 3588

- Cut-out: **14" w x 14" d x 17" h**
- Adds convenience and functionality to your outdoor kitchen. Purchase separately or together. Sink measures **15" x 15" x 6"** and requires a **17"** clearance underneath.



### Protective Grill Covers

Various "F" Styles

- Custom fitted to Fire Magic® grills and accessories, these black covers are manufactured with a PVC exterior and Polyester "breathable" interior providing excellent protection to any Fire Magic® product.



### Charcoal/Smoker Basket

3564-1 (Fits 18" deep Aurora Grills)

3564-2 (Fits All Echelon grills & 22" deep Aurora grills)

- Cooking with wood chunks or charcoal is easier than ever. Basket sits on top of the burner, gas burners ignite the chunks or coals. Includes smoker cover and bottom tray that catches ashes for easy clean-up. Includes easy to use safety cover lifter.



### Warming Rack Extender

3682A

- Dimensions: **14" w x 7" d**
- Add 100 square inches of indirect grilling (or warming) space to **22" deep** Echelon and Aurora Grills with the Warming Rack Extender, simply hook on the rear edge of the existing warming rack.



### Stainless Steel Griddles

3515A (Fits 18" deep Aurora Grills)

3516A (Fits All Echelon grills & 22" deep Aurora grills)

3518 (Fits All Echelon grills & 22" deep Aurora grills)

- This unique grilling accessory heats up fast and allows you to cook all your meals in your outdoor kitchen.



### Power Burner/Dbl. Searing Station Griddle Adapter

3683 (Used with 3515A & 3516A Stainless Steel Griddles)

- Griddle Adapter allows use of both sizes of Fire Magic® Stainless Steel Griddles on your Fire Magic® Power Burner or Double Searing Station.



### Cast Iron Griddles

3512A (Fits 18" deep Aurora Grills)

3513A (Fits All Echelon grills, 22" deep Auroras & Dbl. Side Burners)

- Griddle available for the Fire Magic® double side burner as well as the Echelon and Aurora grills. Perfect for breakfast, grilled vegetables, or fajitas.



### Grilling Tray

3567

- Dimensions: **13½" w x 14¾" d**
- Expand your cooking horizons with the Fire Magic® Grilling Tray. The durable black porcelain finish, angled sides and easy access low profile front makes cooking smaller food on your Fire Magic® grill a snap!



## Premium Accessories

### Cut & Clean Combo

53816

- Cut-out: **9½" w x 4½" d x 15" h**
- Allows you to slice and dice on a Fire Magic® bamboo cutting board, then sweep debris right into the Fire Magic® trash container or basic trash can via a deep stainless steel trash chute. Chute measures 14¾". Stainless steel lid included.



Adjustable chute

### Trash Container

53825-T

- Cut-out: **12¾" w x 20" d x 24" h**
- Constructed of stainless steel with a hands-free foot lever, the door easily slides open to reveal a 10.5 gallon trash can. Fully enclosed.
- Great for use under the Cut & Clean Combo.



### Blender w/ Stainless Steel Hood

3284A

- Cut-out: **8¾" w x 14¾" d**
- Fire Magic's® Blender is the perfect companion for any outdoor kitchen, bar caddy, or beverage center. The attractive and sturdy stainless steel cover protects the 675-watt motor from the elements.



### Four-Piece Tool Set

3575C

- Packed in a handsome zippered nylon logo case, our 4-piece tool set includes stainless steel tongs, meat fork, silicone-tipped basting brush, and slotted flat spatula with serrated edges and built-in bottle opener.



### Wooden Scraper

3502-W

- Dimensions: **17½" w x 4½" d**
- Featuring premium Red Oak hardwood construction for long lasting use, the Fire Magic wooden scraper offers a safe, effective means to remove buildup and residue and keep your Diamond Sear cooking grids ready for grilling.



### Paper Towel Holder

53812

- Cut-out: **12" w x 8" d x 9¼" h**
- Accepts and protects regular or jumbo rolls.



### Wok

3572

- Hard-anodized stick-resistant lined interior surface measures 14" in diameter.



## Premium Accessories

### Gas Timer Box

5520-11T (1-hour timer)

5520-13T (3-hour timer)

- Cut-out: **6½" w x 6½" h**
- Overall dim. w/ flange: **7¾" w x 2½" d x 7¾" h**
- Clean and attractive 304 stainless steel connection box with automatic timer (1-hour or 3-hour).
- Matches Premium Flush (5-series) doors and drawers.



### Gas Connection Box

5520-01T

- Gas connection box with quick disconnect and 1-hour timer. Clean and attractive 304 stainless steel box.



### Automatic Timers

3090 (3-hour timer)

3092B (1-hour timer)

- Fire Magic's 3-hour, and 1-hour, timers automatically shut off gas flow at pre-set times.
- Easy to install.
- Great for apartment and condominium use.



### Grill Light

3574

- This halogen 10 watt bulb makes evening grilling easy. When using the light on a grill without backburner, a light bracket must be ordered. Aurora Light Bracket: **3600-43**, Legacy Light Bracket: **3600-18-SP**.



### Turkey Fryer Kit

3570

- You'll be amazed at how tender a deep-fried turkey can be. Kit includes pot, inner basket with sturdy handle and thermometer probe. Great as a crab or corn pot.



### Bamboo Cutting Board

3582-1

- Dimensions: **14" w x 12" d**
- This durable and functional Bamboo Cutting Board is perfect for preparing meats and vegetables for grilling.



### Rotisserie Basket

3618

- A versatile, stainless steel basket for skewers, burgers, ribs or fish.

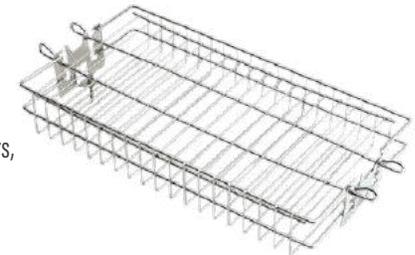

### Turkey Holder

3615E

- This sturdy holder is also perfect for beef, pork and lamb roasts.



### Chicken Holder

3617E

- Enjoy a golden, succulent chicken the quick and easy way!



## Insulating Liner

The Insulating Liner facilitates installation of built-in Fire Magic® grills into wood, composite or other combustible enclosures when used with non-combustible counter tops. Sizes are available for all Echelon, Aurora and Legacy Deluxe grills as well as Power Burners & Searing Stations.

### Feature Highlights:

- Hanger for easy installation
- Reduced clearance
- No additional support beneath the liner required
- 304 stainless steel construction
- Pre-assembled in box

### Available Insulating Liner Models

<b>3185-52</b>	Used with Echelon <b>E1060i</b> Built-In Grills
<b>3186-52</b>	Used with Echelon <b>E790i</b> & Aurora <b>A790i</b> Built-In Grills
<b>3176-52</b>	Used with Echelon <b>E660i</b> & Aurora <b>A660i</b> Built-In Grills
<b>23150-52</b>	Used with Aurora <b>A540i</b> & Choice <b>C540i</b> Built-In Grills
<b>23130-52</b>	Used with Aurora <b>A430i</b> & Choice <b>C430i</b> Built-In Grills
<b>3177-52</b>	Used with Choice <b>C650i</b> Built-In Grill
<b>3100-51</b>	Deluxe Built-In Grill
<b>3278-52</b>	Power Burner & Double Searing Station
<b>3287-52</b>	Searing Station



## Vent Hood

Fire Magic's Power Vent Hood is designed specifically for the outdoor grilling environment to exhaust excess smoke and heat from covered patios. The 1200 CFM dual fan design may be configured to vent either vertically or horizontally to suit the application. Powerful under-mount halogen lamps illuminate the space for evening grilling.



42" Vent Hood  
42-VH-7

### Vent Hood Specifications

Electrical requirements	120VAC / 60 Hz / 15 AMP min. / GFCI outlet
Blowers (2)	1,200 CFM (600 CFM Each)
Power Consumption	1,010 watts
Halogen Lights Rating	120V / 50 watt halogen light bulb

### Feature Highlights:

- Powerful, convertible (top-vent or rear-vent) dual blowers (1200 CFM total) specifically designed and engineered to quickly extract smoke, heat, grease, and odors from the front or rear of the hood
- High quality brushed 304 stainless steel construction with seamless polished edges
- Dual halogen under-mount lamps provide generous light for evening grilling
- Thermal safety sensor automatically activates fans when temperature reaches 140° F
- On demand control knobs offer a high and low setting for lights and fan
- Anodized aluminum filters remove easily and are dishwasher safe
- Available in 36", 42", 48", and 60" widths

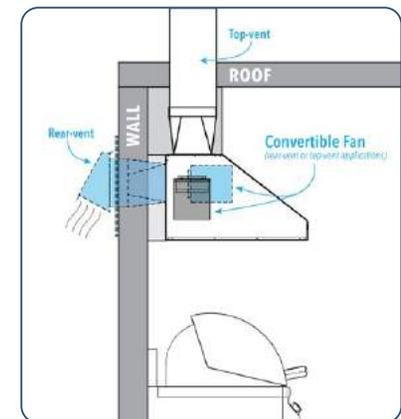



# DOORS & DRAWERS

All cut-out dimensions, images and diagrams are for reference purposes only. Fire Magic® reserves the right to change the information contained in this catalog without notice. Please refer to your instruction manual for the most up to date information specific to your product.

# FLUSH MOUNTED

## Doors & Drawers (5 Series)



Featuring heavy-duty handles with polished mounts, these 304 stainless steel doors and drawers are designed to close flush with the frame using a strong magnetic latch. Flush Mounted Doors and Drawers are filled with polyurethane foam for insulation and a solid feel. A continuous rain guard protects from water getting into your custom enclosure. In addition, most 5-Series doors and drawers now have a soft-close feature for



smooth transition while opening and closing. Available in a variation of door and drawer

configurations and sizes. With so many options there is a combination available to meet any outdoor kitchen storage need. Pantry sealed and gasketed Door/Drawer combos feature self-closing, magnetic seal drawers.

### Doors and Drawers | Flush Mounted (5 Series)



#### NEW Locking Storage Doors

Keep your BBQ tools and supplies secure with new Fire Magic storage doors equipped with lock and key.



Model Shown: 53920KSC-L

#### Vert. Single Access Doors

Model #	Hinge	Cut-out
53920KSC-R	Right	21" h x 14½" w
53920KSC-L	Left	21" h x 14½" w
53924KSC-R	Right	25" h x 17½" w
53924KSC-L	Left	25" h x 17½" w

#### Horiz. Single Access Doors

Model #	Hinge	Cut-out
53914KSC-R	Right	15" h x 20½" w
53914KSC-L	Left	15" h x 20½" w
53917KSC-R	Right	18" h x 24½" w
53917KSC-L	Left	18" h x 24½" w



Model Shown: 53930KSC

#### Dbl. Access Doors

Model #	Cut-out
53934KSC	15" h x 30" w
53930KSC	21" h x 30" w
53938KSC	16" h x 39" w

### Vertical Single Access Doors

Model #	Hinge	Cut-out
53920SC-R	Right	21" h x 14½" w
53920SC-L	Left	21" h x 14½" w
53924SC-R	Right	25" h x 17½" w
53924SC-L	Left	25" h x 17½" w



Model Shown: 53920SC-L

### Horizontal Single Access Doors

Model #	Hinge	Cut-out
53914SC-R	Right	15" h x 20½" w
53914SC-L	Left	15" h x 20½" w
53917SC-R	Right	18" h x 24½" w
53917SC-L	Left	18" h x 24½" w



Model Shown: 53917SC-R

### Double Access Doors

Model #	Cut-out
53934SC	15" h x 30" w
53930SC	21" h x 30" w
53938SC	16" h x 39" w



Model Shown: 53930SC



#### Large Pantry Door/Drawer Combo

54020S

• Cut-out: 33½" h x 20" w x 26" d



#### Medium Pantry Door/Drawer Combo

54018S

• Cut-out: 25" h x 17½" w x 26" d

**Doors and Drawers** | Flush Mounted (5 Series)



**Door/Drawer Combo** w/ Platter Storage  
**53816SC**  
 • Cut-out: **18½" h x 36½" w x 26" d**



**Door/Drawer Combo**  
**53810SC**  
 • Cut-out: **18½" h x 30" w x 26" d**



**Double Doors w/ Dual Drawers**  
**53930SC-22**  
 • Cut-out: **21" h x 30½" w x 20½" d**



**Double Doors w/ Tank Tray & Dual Drawers**  
**53930SC-12** (w/o Louvers shown)  
**53930SC-12T** (w/ Louvers)  
 • Cut-out: **21" h x 30½" w x 20½" d**



**Electric Warming Drawer**  
**53830-SW**  
 • Cut-out: **14½" h x 32¼" w x 22" d**  
 • Buffet Warming Accessory available for this unit;  
 Model #: **23830-SW-CD**



**Large Utility Drawer**  
**53830SC**  
 • Cut-out: **14½" h x 32¼" w x 22" d**  
 • Includes Utensil Bin



**Single Door w/ Dual Drawers**  
**53820SC-R (-L)**  
 • Cut-out: **21" h x 14½" w x 20½" d**



**Door w/ Tank Tray & Louvers**  
**53820SC-TL (-TR)**  
 • Cut-out: **21" h x 14½" w x 20½" d**



**Utensil Bin**  
 (Included with Triple, Double, and Single Drawers)

**Single Drawer**  
**53801SC**  
 • Cut-out: **5¼" h x 14½" w x 20½" d**  
 • Includes Utensil Bin



**Utensil Bin**  
 (Included with Triple, Double, and Single Drawers)

**Double Drawer**  
**53802SC**  
 • Cut-out: **16" h x 14½" w x 20½" d**  
 • Includes Utensil Bin



**Triple Drawer**  
**53803SC**  
 • Cut-out: **26¼" h x 14½" w x 20½" d**  
 • Includes Utensil Bin



**Trash Cabinet**  
**53820TSC**  
 • Cut-out: **21" h x 14½" w x 19¼" d**  
 • Includes two 3.25 gallon trash bins (1 black, 1 blue).

# SELECT

## Doors & Drawers (3 Series)



These 304 stainless steel doors and drawers feature outside mounting, double wall and square edge construction, a slim tubular stainless steel handle, and heavy-duty magnetic latch. A continuous rain guard protects from water getting into your custom enclosure. Available in a large variety of door and drawer configurations and styles.

### Doors and Drawers | Select (3 Series)

#### Vertical Single Access Doors

Model #	Hinge	Cut-out
<b>33920-SR</b>	Right	<b>21" h x 14½" w</b>
<b>33920-SL</b>	Left	<b>21" h x 14½" w</b>
<b>33924-SR</b>	Right	<b>25" h x 17½" w</b>
<b>33924-SL</b>	Left	<b>25" h x 17½" w</b>



Model Shown: **33920-SR**



Model Shown: **33924-SR**

#### Horizontal Single Access Doors

Model #	Hinge	Cut-out
<b>33914-SR</b>	Right	<b>15" h x 20½" w</b>
<b>33914-SL</b>	Left	<b>15" h x 20½" w</b>
<b>33917-SR</b>	Right	<b>18" h x 24½" w</b>
<b>33917-SL</b>	Left	<b>18" h x 24½" w</b>



Model Shown: **33914-SR**



Model Shown: **33917-SR**

#### Double Access Doors

Model #	Cut-out
<b>33930S</b>	<b>21" h x 30" w</b>
<b>33938S</b>	<b>16" h x 39" w</b>



Model Shown: **33930S**



Model Shown: **33938S**

**Doors and Drawers** | Select (3 Series)



**Door/Drawer Combo** w/ Platter Storage  
**33816S**

• Cut-out: **18½" h x 36½" w x 26" d**



**Door/Drawer Combo**  
**33810S**

• Cut-out: **18½" h x 30" w x 26" d**



**Double Doors w/ Dual Drawers**  
**33930S-22**

• Cut-out: **21" h x 30½" w x 20½" d**



**Double Doors w/ Tank Tray & Dual Drawers**

**33930S-12T** (w/ Louvers shown)

**33930S-12** (w/o Louvers)

• Cut-out: **21" h x 30½" w x 20½" d**



**Electric Warming Drawer**  
**33830-SW**

• Cut-out: **13" h x 31" w x 20½" d**  
• Buffet Warming Accessory available for this unit;  
Model #: **23830-SW-CD**



**Large Utility Drawer**  
**33830-S**

• Cut-out: **13" h x 31" w x 20½" d**  
• Includes Utensil Bin



**Single Door w/ Dual Drawers**  
**33820-SR (-SL)**

• Cut-out: **21" h x 14½" w x 20½" d**



**Door w/ Tank Tray & Louvers**  
**33820-TSL (-TSR)**

• Cut-out: **21" h x 14½" w x 20½" d**



**Single Access Door w/ Louvers**  
**33920-1-SL (-SR)**

• Cut-out: **21" h x 14½" w**



**Utensil Bin**  
(Included with Triple, Double, and Single Drawers)



**Single Drawer**  
**33801**

• Cut-out: **5¼" h x 14½" w x 20½" d**  
• Includes Utensil Bin

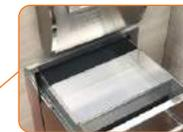

**Utensil Bin**  
(Included with Triple, Double, and Single Drawers)



**Double Drawer**  
**33802**

• Cut-out: **16" h x 14½" w x 20½" d**  
• Includes Utensil Bin



**Triple Drawer**  
**33803**

• Cut-out: **26¼" h x 14½" w x 20½" d**  
• Includes Utensil Bin

# LEGACY

## Doors & Drawers (2 Series)



Outside mounted with angled edges, the Legacy Doors and Drawers are made of 304 stainless steel and feature a slam latch for secure closure.

The Legacy doors and drawers are the most economical for builders and homeowners alike.

### Doors and Drawers | Legacy (2 Series)



Model Shown: 23912-S

#### Horizontal Single Access Doors

Model #	Hinge	Cut-out
23912-S	Reversible	12½" h x 18½" w
23914-S	Reversible	14½" h x 20½" w
23917-S	Reversible	17½" h x 24½" w



Model Shown: 23920-S

#### Vertical Single Access Doors

Model #	Hinge	Cut-out
23918-S	Reversible	18½" h x 12½" w
23920-S	Reversible	20½" h x 14½" w
23924-S	Reversible	24½" h x 17½" w
23920-1-S*	--	20½" h x 14½" w

\* Door includes louvers



#### Door w/ Tank Tray & Louvers

23920-1T-S

• Cut-out: 20½" h x 14½" w x 20½" d



#### Double Access Doors

23930-S

• Cut-out: 20½" h x 30" w



#### Louvered Stainless Steel Venting Panel

5510-01

• Cut-out: 5" h x 12¼" w

• Overall Panel Size: 6" h x 14" w

## FIRE MAGIC® OUTDOOR GAS GRILL AND ACCESSORY WARRANTY HIGHLIGHTS \*

Crafted with pride in the USA and constructed entirely of 304 stainless steel, Fire Magic® has been manufacturing the finest outdoor grills and accessories you can buy for over 80 years. Our warranty coverage reflects the quality materials and craftsmanship found in all Fire Magic® grills.

When investing in a grill, consider the assurance provided by the Fire Magic® warranty:

- Fire Magic® pays for first **two years** warranty labor allowance
- Fire Magic® pays for shipping warrantied replacement parts
- Fire Magic® pays for shipping warrantied defective parts back to the factory
- Fire Magic's® qualified technical service representatives are available 10 hours a day, 5 days a week to assist with questions, installation, and service

You will find the Fire Magic® warranty to be the best and most comprehensive in the industry.

### LIFETIME WARRANTY

Cast stainless steel burners, Choice stainless steel u-shaped burners, Diamond Sear and rod stainless steel cooking grids, and stainless steel housings.

### FIFTEEN (15) YEAR WARRANTY

Brass valves, inner liners, manifold assemblies, porcelain housings (including ovens and barbecue faces), and backburner assemblies (except ignition parts).

### TEN (10) YEAR WARRANTY

Electric grills, stainless steel cooking grids and housings (excluding electronic components).  
Gourmet Griddles (except ignition system) are warranted for ten years.

### FIVE (5) YEAR WARRANTY

Flavor grids, infrared burners in the grill, and Charcoal stainless steel grills (except for the charcoal pan, charcoal grid, thermometer and ash tray; which are warranted for one (1) year).

### THREE (3) YEAR WARRANTY

Side burners and all other Fire Magic® grill components (except ignition and electronic parts).

### ONE (1) YEAR WARRANTY

Ignition systems (except batteries), electronic components (including lights & thermometers) and grill accessories.

***This warranty applies to the original purchaser with proof of purchase and to single family residential use only.***  
For additional information regarding this warranty, or to place a warranty claim contact your authorized Fire Magic® dealer.

*\*See full warranty for complete details.*

All cut-out dimensions, images and diagrams are for reference purposes only. Fire Magic® reserves the right to change the information contained in this catalog without notice. Please refer to your instruction manual for the most up to date information specific to your product.

Lifestyle expert, chef and Fire Magic spokesperson **Anna Rossi** shares a moment with grill master **Steven Raichlen**.



# FIREMAGIC®

BUILT WITH PASSION. OWNED WITH PRIDE.

14724 East Proctor Ave., City of Industry, CA 91746

[www.firemagicgrills.com](http://www.firemagicgrills.com)

