

---

ECAM29X2Y - 29X3Y - 29X4Y

# MAGNIFICA — EVO —

## COFFEE MAKER

Instructions for use. Keep these instructions

Visit [www.delonghi.com](http://www.delonghi.com) for a list of service centers  
near you.

## ELECTRIC CHARACTERISTICS

120 V~ 60 Hz 1250 W



## MACHINE À CAFÉ

Mode d'emploi . Conservez cette notice

Visitez [www.delonghi.com](http://www.delonghi.com) pour y voir une liste des  
centres de réparation proches de chez vous.

## CARACTÉRISTIQUES ÉLECTRIQUES

120 V~ 60 HZ 1250 W

## CAFETERA

Repase y guarde estas instrucciones.

Lea cuidadosamente este instructivo antes de usar  
su aparato.

Visite [www.delonghi.com](http://www.delonghi.com) para ver la lista de  
centros de servicios cercanos a usted.

## CARACTERISTICAS ELECTRICAS:

120 V~ 60 HZ 1250 W

Instructions videos available at:  
<http://magnifica-evo.delonghi.com>



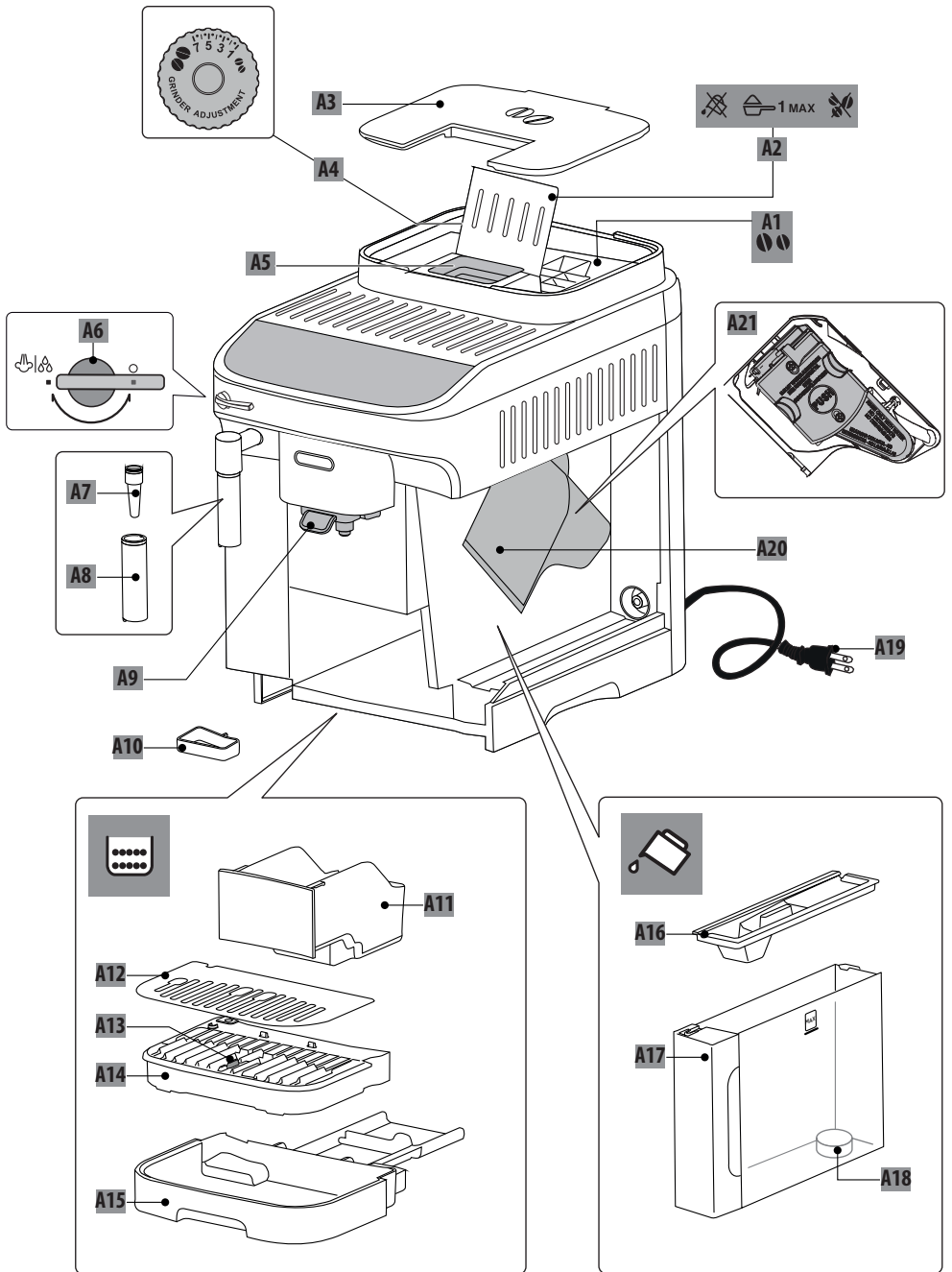

---

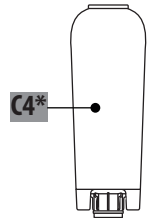
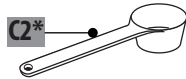
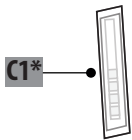
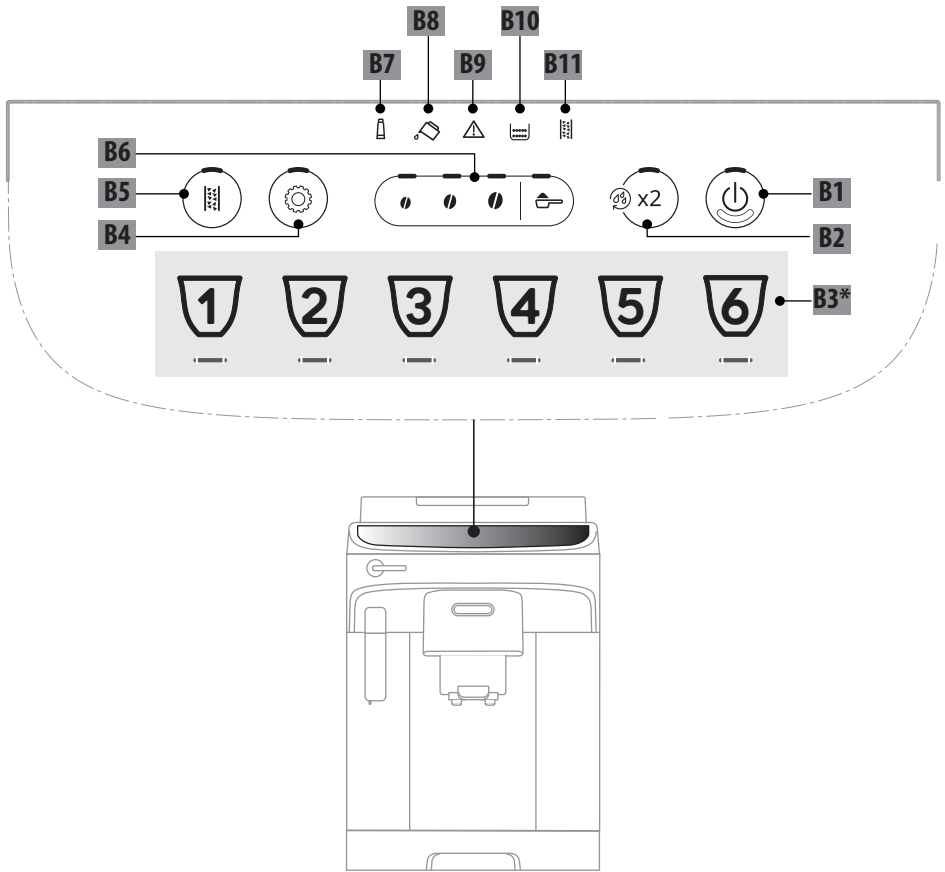
**DeLonghi**





## CONTENTS

<b>1. SAFETY WARNINGS</b> .....	<b>6</b>
<b>2. GENERAL INFORMATION</b> .....	<b>6</b>
2.1 Instruction for Use.....	6
<b>3. BEFORE USE</b> .....	<b>6</b>
3.1 Checking the appliance .....	6
3.2 Installing the appliance.....	6
3.3 Connecting the appliance.....	6
3.4 Setting up the appliance .....	6
3.5 Cleaning and maintenance of materials in contact with food .....	6
3.6 Making cappuccinos and milk-based coffees	7
<b>4. INTRODUCTION</b> .....	<b>7</b>
<b>5. DESCRIPTION</b> .....	<b>7</b>
5.1 Description of the appliance - A.....	7
5.2 Description of the control panel - B.....	7
5.3 Description of the accessories - C.....	7
<b>6. SETTING UP THE APPLIANCE</b>  .....	<b>8</b>
<b>7. TURNING THE MACHINE ON AND OFF</b> .....	<b>9</b>
<b>8. MAKING COFFEE</b> .....	<b>9</b>
8.1 Making 1 cup of coffee using coffee beans	9
8.2 Making 2 cups of coffee using coffee beans .....	10
8.3 Varying the coffee strength.....	10
8.4 Rinsing .....	10
8.5 Tips for a hotter coffee.....	10
8.6 Adjusting the coffee grinder.....	10
8.7 Customizing the quantity in the cup .....	11
8.8 Making coffee using pre-ground coffee	11
<b>9. MAKING OVER ICE</b>  .....	<b>12</b>
<b>10. MAKING HOT WATER</b>  .....	<b>12</b>
<b>11. MAKING CAPPUCCINO</b>  .....	<b>13</b>
<b>12. MEASURING WATER HARDNESS</b> .....	<b>14</b>
<b>13. WATER SOFTENER FILTER</b> .....	<b>14</b>
13.1 Replacing the filter.....	15
13.2 Removing the filter .....	16
<b>14. TIPS FOR ENERGY SAVING</b> .....	<b>16</b>
<b>15. SETTINGS MENU</b> .....	<b>17</b>
15.1 Reset default values.....	19
<b>17. CLEANING THE INFUSER</b> .....	<b>21</b>
<b>18. DESCALING</b>  .....	<b>22</b>
<b>19. EXPLANATION OF INDICATOR LIGHTS</b> .....	<b>25</b>
<b>20. TROUBLESHOOTING</b> .....	<b>27</b>

# IMPORTANT SAFEGUARDS

When using electrical appliances, basic safety precautions should always be followed, including the following.

- Read all instructions carefully.
- Make sure the voltage of your electrical system corresponds to the voltage shown on the bottom of the machine.
- Do not touch hot surfaces. Use handles or knobs.
- To protect against fire, electrical shock and personal injury, do not immerse cord, plug or appliance in water or other liquid.
- Keep the appliance out of the reach of children and do not leave appliance unattended while in operation.
- Unplug from the outlet when not in use and before cleaning.
- Do not operate with a damaged cord or plug, or after the appliance malfunctions, or has been damaged in any manner. Return the appliance to the nearest authorized service facility for examination, repair or adjustment.
- The use of accessory attachments not recommended by the manufacturer may result in fire, electrical shock, or personal injury.
- Do not use outdoors.
- Make sure the power cord does not hang over the edge of the table or counter-top to avoid getting accidentally caught or entangled.
- Do not place the appliance or its electrical parts on or near electric stoves, cooking surfaces, or gas burners.
- Plug cord into the wall outlet. To disconnect, first turn machine "off", then remove plug from wall outlet.
- Do not use the appliance for other than the intended use. This appliance is to be utilized for domestic use only. The manufacturer declines all responsibility for any damage caused by improper, incorrect, or irresponsible use.

**WARNING: To reduce the risk of fire or electric shock, do not remove the cover or the exterior of the unit. Don't attempt to repair or modify the machine, doing so will void the warranty. Repair should be done by authorized service personnel only!**

## SAVE THESE INSTRUCTIONS

THIS APPLIANCE IS FOR HOUSEHOLD USE ONLY

## SHORT CORD INSTRUCTIONS

- A short power cord is provided to reduce risks resulting from becoming entangled in or tripping over a longer cord.
- Longer, detachable power supply cords or extension cords are available and may be used if care is exercised in their use.
- If an extension cord is used, the marked electrical rating should be at least as great as the electrical rating of the appliance. If the appliance is provided with 3- wire, grounding type cord, the extension should be a GROUNDING TYPE 3 - WIRE CORD. The longer cord should be arranged so that it will not drape over the counter-top or table top where it can be pulled on by children or tripped over.
- Your product is equipped with a polarized alternating current line plug (a plug having one blade wider than the other). This plug will fit into the power outlet only one way. This is a safety feature. If you are unable to insert the plug fully into the outlet, try reversing the plug. If the plug should still fail to fit, contact your electrician to replace your obsolete outlet. Do not defeat the safety purpose of the polarized plug.

## 1. SAFETY WARNINGS

---

### ***Danger!***

This is an electrical appliance and may cause electric shock.

You should therefore follow these safety warnings:

- Never touch the appliance with damp hands or feet.
- Never touch the plug with damp hands.
- Make sure the socket used is freely accessible at all times, enabling the appliance to be unplugged when necessary.
- Unplug directly from the plug only. Never pull the cord as you could damage it.
- To disconnect the appliance completely you must unplug it from the mains socket.
- If the appliance is faulty, do not attempt to repair. Turn it off, unplug from the mains socket and contact Customer Services.
- Before cleaning the appliance, turn it off, unplug from the mains socket and allow to cool.

### ***Important!***

Keep all packaging (plastic bags, polystyrene foam) away from children.

**CHOKING HAZARD.** The appliance might contain small parts. Some of those small parts might be required to get disassembled during cleaning and maintenance operations. Handle with care and keep small parts out of reach of children.

### ***Danger of burns!***

This appliance produces hot water and steam may form while it is in operation.

**During operation (automatic rinsing, hot beverage delivery, steam delivery, cleaning), avoid contact with splashes of hot water or steam.**

When the appliance is in operation, the cup shelf could become very hot.

## 2. GENERAL INFORMATION

---

### 2.1 Instruction for Use

Read all the Instruction for Use carefully before using the appliance. Failure to follow this Instruction for Use may result in burns or damage to the appliance.

The manufacturer is not liable for damage deriving from failure to respect this Instruction for Use.

### ***Please note:***

**These safety warnings are valid for all De'Longhi coffee machines.**

**Keep this leaflet together with the instructions accompanying the appliance.**

If the appliance is passed to other persons, they must also be provided with this Instruction for Use.

## 3. BEFORE USE

---

### 3.1 Checking the appliance

After removing the packaging, make sure the product is complete and undamaged and that all accessories are present. Do not use the appliance if it is visibly damaged. Contact De'Longhi Customer Services.

### 3.2 Installing the appliance

When you install the appliance, you should respect the following safety warnings:

- The appliance gives off heat. After positioning the appliance on the worktop, leave a space of at least 1.18 in / 3 cm between the surfaces of the appliance and the side and rear walls and at least 5.9 in / 15 cm above the coffee maker.
- Water penetrating the appliance could cause damage. Do not place the appliance near taps or sinks.
- The appliance could be damaged if the water it contains freezes. Do not install the appliance in a room where the temperature could drop below freezing point.
- Arrange the power cord in such a way that it cannot be damaged by sharp edges or contact with hot surfaces (e.g. electric hot plates).

### 3.3 Connecting the appliance

Check that the mains power supply voltage corresponds to that indicated on the rating plate on the bottom of the appliance.

Connect the appliance to an efficiently earthed and correctly installed socket with a minimum current rating of 13A only.

If the power socket does not match the plug on the appliance, have the socket replaced with a suitable type by a qualified professional.

### 3.4 Setting up the appliance

The first time you use the machine, the water circuit is empty and the appliance could be very noisy. The noise becomes less as the circuit fills.

### 3.5 Cleaning and maintenance of materials in contact with food

- When used for the first time, or after 3 or 4 days without use, clean the appliance and the removable accessories that come into contact with water, coffee and milk, as indicated in the instructions for use. Check in the instructions which accessories are dishwasher safe.
- If the appliance is not used for more than 3 or 4 days, before making the first beverage, rinse the water circuit as described in this Instruction for Use.
- Be certain to take maximum care when carrying out all cleaning and maintenance operations described in the

instructions for use and/or prompted by the display or warning lights of the appliance itself.

### 3.6 Making cappuccinos and milk-based coffees





- The appliance has been tested for use with cow's milk and the following products of plant origin: soya, rice and almond. No other type of milk or product of plant origin may be used.
- To clean the system, following use with any type of milk, please follow the standard procedures described in the instruction manual
- The cleaning methods provided by the manufacturer and described in the instructions do not guarantee the complete removal of allergens.
- In the case of confirmed or suspected allergies and intolerances, make sure that your machine has not been previously used with any milk or product of plant origin containing the allergens you are allergic or the substances you are intolerant to.

## 4. INTRODUCTION

The principal functions of the machine are summarized in the Quick Guide.

Take a few minutes to read this Instruction for Use. This will avoid all risks and damage to the appliance.

The LEDs and indicator lights on the panel will help you interact with the machine and use the various functions correctly:

	Off	--
	On steadily	Function available
	Flashing	Function in progress
	Fast blink	User action needed

## 5. DESCRIPTION

### 5.1 Description of the appliance - A

- A1. Beans container
- A2. Pre-ground coffee funnel lid
- A3. Beans container lid
- A4. Grinding adjustment dial
- A5. Pre-ground coffee funnel
- A6. Steam/hot water dial
- A7. Rubber nozzle
- A8. Steam/hot water wand
- A9. Coffee spouts (adjustable height)
- A10. Condensate tray
- A11. Grounds container
- A12. Cup tray
- A13. Drip tray water level indicator
- A14. Drip tray grille
- A15. Drip tray
- A16. Water tank lid
- A17. Water tank
- A18. Water filter housing
- A19. Power cord
- A20. Infuser door
- A21. Infuser

### 5.2 Description of the control panel - B

- B1. ON/Standby button with LED integrated light
- B2. X2 button with integrated led (Rinsing function when pressed and hold for 5 seconds)
- B3. Direct recipes with integrate led (\*number and type of recipes may vary depending on the model )
- B4. Setting menu button with LED integrated light
- B5. Descaling button with LED integrated light
- B6. Strength selection and pre-ground function buttons
- B7. Exhausted water filter indicator light
- B8. On steadily indicator light: insufficient water in the tank (A17)  
Flashing indicator light: the water tank is extracted
- B9. General alarm indicator light
- B10. On steadily indicator light: the grounds container (A11) needs to be emptied  
Flashing indicator light: put the grounds container back in place
- B11. Descaling indicator light

### 5.3 Description of the accessories - C

- C1. Total Hardness Test
- C2. Measuring spoon for pre-ground coffee
- C3. Descaler
- C4. Water softner filter

## 6. SETTING UP THE APPLIANCE

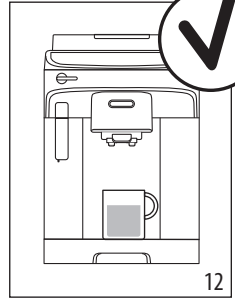
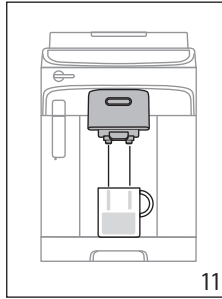
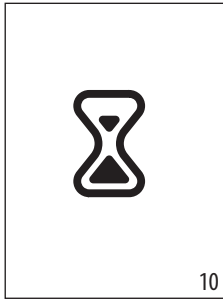
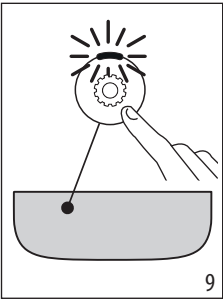
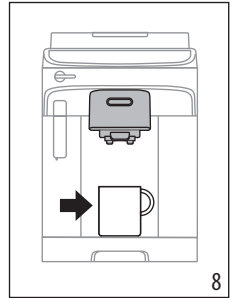
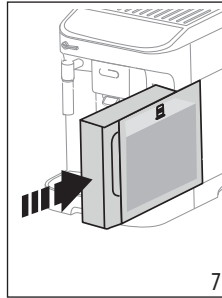
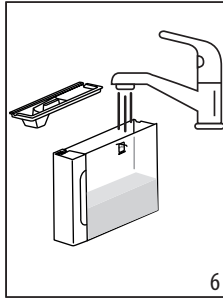
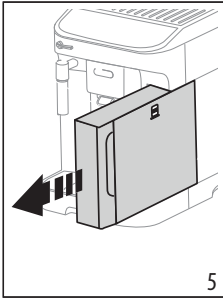
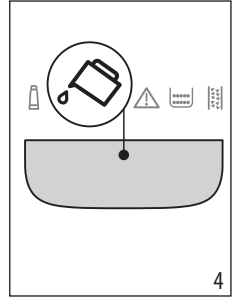
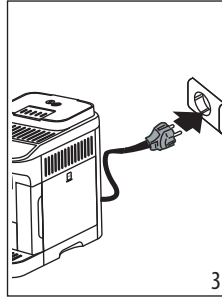
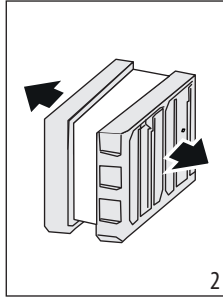
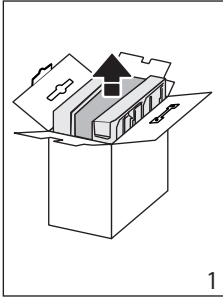

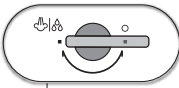
  Make sure the steam knob is on 0 pos.

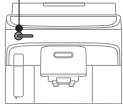



- When using the machine for the first time, 4-5 coffees will need to be made before it starts giving satisfactory results.
- The first time you use the machine, the water circuit is empty and the appliance could be very noisy. The noise becomes less as the circuit fills.
- Possible traces of coffee in the grinder are the result of settings tests performed on the appliance before sale, proof of the meticulous care and attention we invest in our products.

## 7. TURNING THE MACHINE ON AND OFF

- Each time the appliance is turned on, it performs an automatic preheat and rinse cycle which cannot be interrupted. The appliance is not ready for use until the cycle has been completed.
- Whenever the machine is turned off after being used to make coffee, it performs an automatic rinse cycle.

### **Danger of scalding!**

During rinsing, a little hot water flows from the coffee spouts. Take care to avoid contact with splashes of water.

- To turn the appliance on or off, press the  button.

If you will not be using the appliance for some time, unplug it from the mains socket:

## 8. MAKING COFFEE

### 8.1 Making 1 cup of coffee using coffee beans

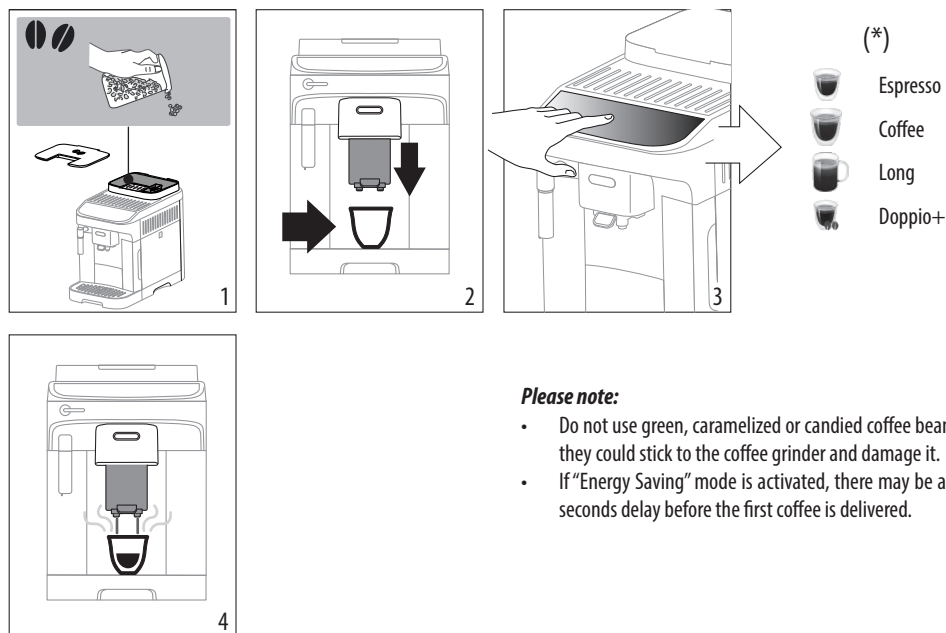

### **Please note:**

- Do not use green, caramelized or candied coffee beans as they could stick to the coffee grinder and damage it.
- If "Energy Saving" mode is activated, there may be a few seconds delay before the first coffee is delivered.

## 8.2 Making 2 cups of coffee using coffee beans

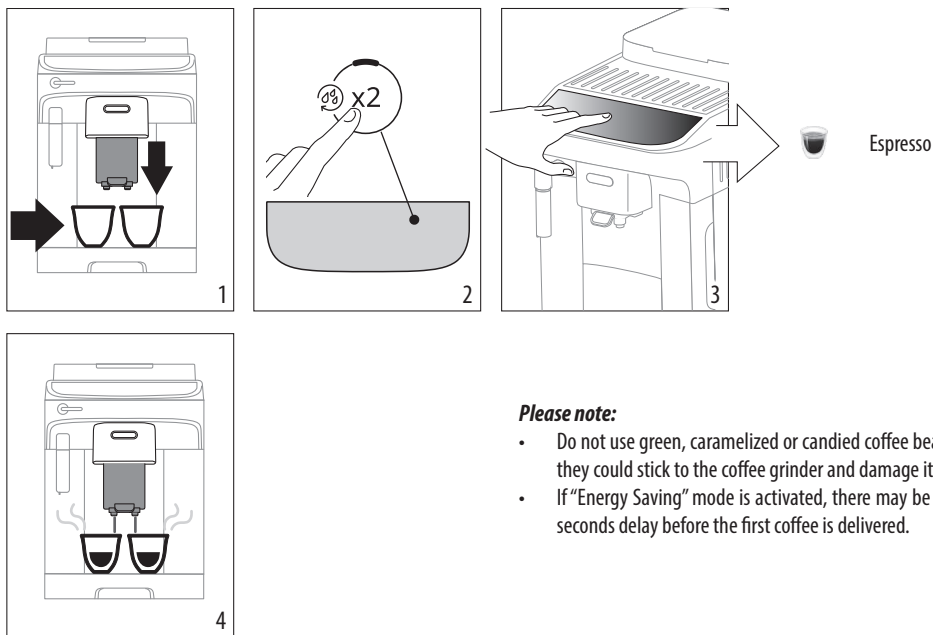



### **Please note:**

- Do not use green, caramelized or candied coffee beans as they could stick to the coffee grinder and damage it.
- If "Energy Saving" mode is activated, there may be a few seconds delay before the first coffee is delivered.

## 8.3 Varying the coffee strength

1. Press the button corresponding to the preferred strength:

	Mild
	Medium
	Strong

2. Select the desired coffee beverage.

### **Please note:**

- When the next coffee is made, the machine will propose the last strength selected.
- In the event of power failure, the machine will revert to the medium default setting.

## 8.4 Rinsing

Use this function to deliver hot water from the coffee spouts to clean and heat the appliance's internal circuit.

To perform the rinse cycle, just press and hold the  button for about 5 seconds. Delivery stops automatically (to interrupt delivery earlier, press the same button again).

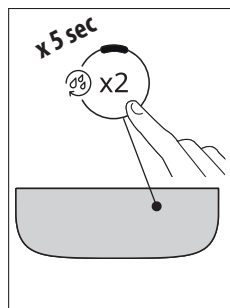

## 8.5 Tips for a hotter coffee



To make a hotter coffee, proceed as follows:

- perform a rinse cycle (see paragraph "8.4 Rinsing";
- use warmed cups (i.e. rinse them with hot water before use)
- increase the coffee temperature (see section "15. Settings menu").

## 8.6 Adjusting the coffee grinder

The coffee grinder is set by default to prepare coffee correctly and should not require regulating initially.

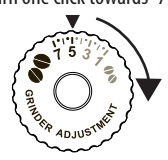
To adjust, while the coffee grinder is in operation, turn the dial as follows:





<p>If the coffee is over-extracted, delivery too slowly or not at all, you need a more coarse ground setting. This adjustment will not take effect until at least 2 cups of coffee have been delivered.</p>	<p>Turn one click towards "7"</p> 
<p>If the coffee is under-extracted, delivery too fast and has no crema, you need a finer ground setting. This adjustment will not take effect until at least 2 cups of coffee have been delivered.</p>	<p>Turn one click towards "1"</p> 

**Please note:**

The grinding adjustment dial must only be turned when the coffee grinder is in operation during the initial phase of coffee preparation.

### 8.7 Customizing the quantity in the cup

1. Press and hold for few seconds the button relative to the beverage you want to customize: the programming starts when the indicator light blinks fast and coffee delivery begins;
2. Once the cup is filled to the desired level, press the beverage button again. Delivery stops and the quantity is saved in the memory.

Beverage*	Default (fl oz / ml)	Programmable (fl oz / ml)
 Espresso	1.35 / 40	from $\approx 0.68 / 20$ to $\approx 6.08 / 180$
 Coffee	6.08 / 180	from $\approx 3.38 / 100$ to $\approx 8.11 / 240$
 Long	5.41 / 160	from $\approx 3.89 / 115$ to $\approx 8.45 / 250$
 Doppio+	4.05 / 120	from $\approx 2.70 / 80$ to $\approx 6.08 / 180$
 Over ice	3.38 / 100	from $\approx 1.35 / 40$ to $\approx 8.11 / 240$

(\*) Number and type of recipes may vary depending on the model



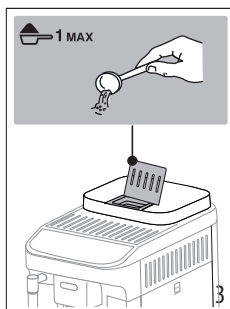
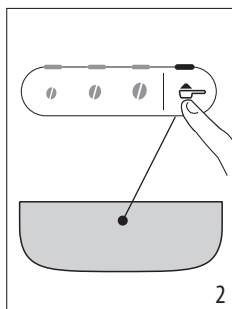
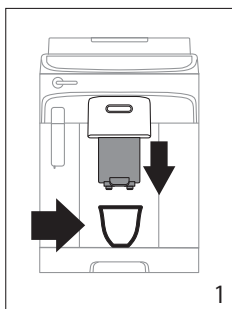

**Please note!**

To cancel the current programme, press a button corresponding to another beverage

### 8.8 Making coffee using pre-ground coffee



**Please note:**

- Never add pre-ground coffee when the machine is off or it could spread through the inside of the machine and dirty it. This could damage the machine.
- Never use more than one measuring spoon as it could dirty the inside of the machine or block the funnel.
- Making  **LONG** coffee: halfway through preparation, when the  +  lights come on, add one measuring spoon of pre-ground coffee and press the Long button again.
- You cannot make  **Doppio+** coffee using pre-ground coffee.

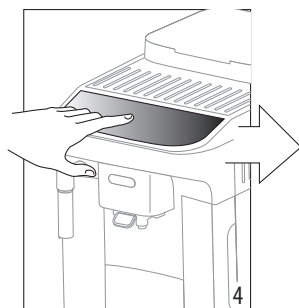

(\*)

-  Espresso
-  Coffee
-  Long

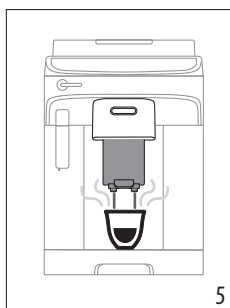

## 9. MAKING OVER ICE

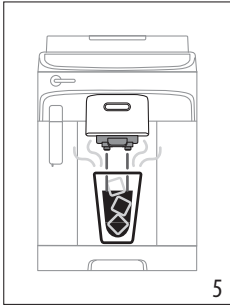
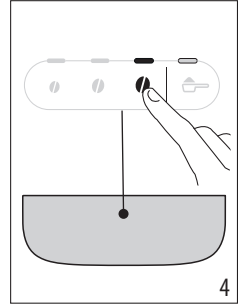
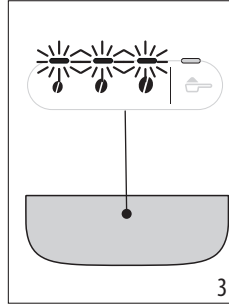
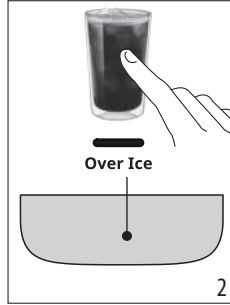
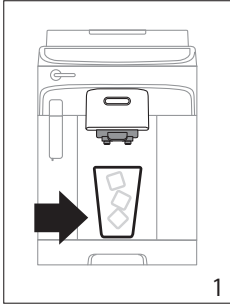

**Please note:**

- Strong strength selection is recommended.
- Always use glasses resistant to thermal shock.

## 10. MAKING HOT WATER

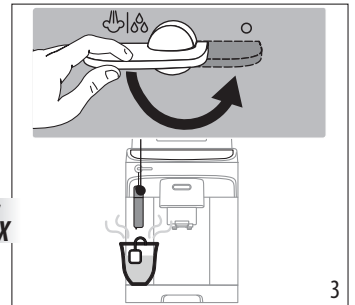
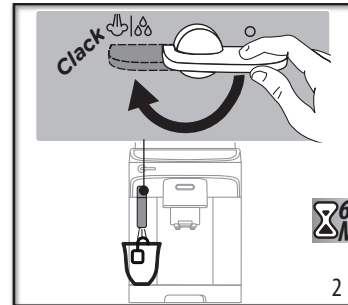
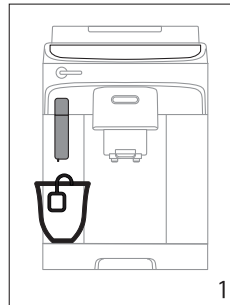

## 11. MAKING CAPPUCCINO

- To make one cappuccino fill a stainless steel jug with about 3.38 Fl oz / 100 ml of cold milk. When choosing the size of the container, bear in mind that the milk doubles or triples in volume.
- For a richer, denser froth, use skimmed or partially skimmed milk at refrigerator temperature (about 41°F/5°C). Clean the cappuccino maker every time after use. This will also help to ensure the best froth result and avoid large bubbles.
- The quality of the froth may vary depending on:
  - the type of milk or plant based alternatives;
  - the brand used;
  - the ingredients and nutritional values.

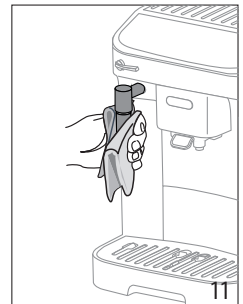
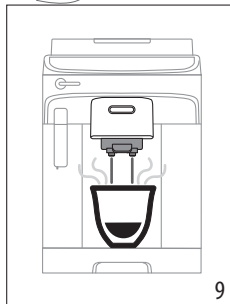
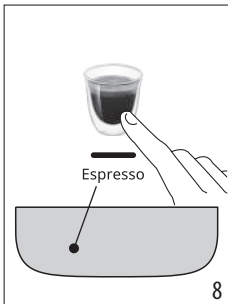
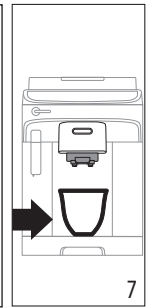
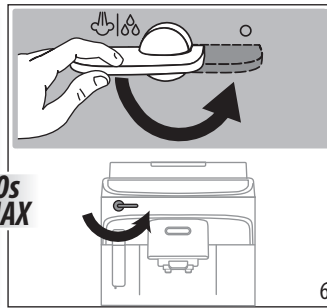
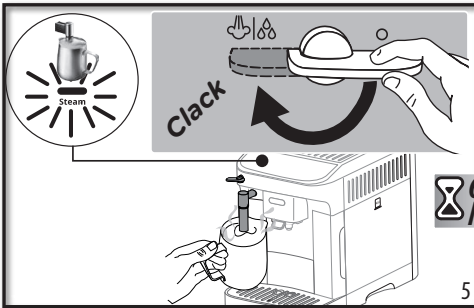
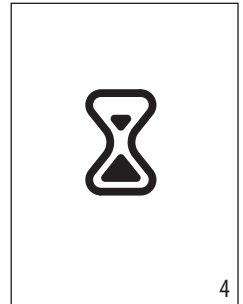
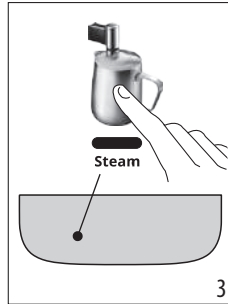
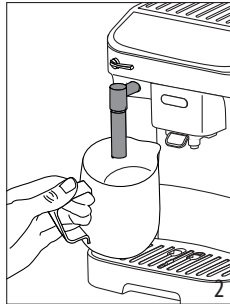
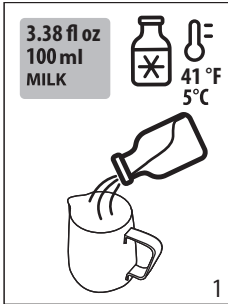

## 12. MEASURING WATER HARDNESS

The descaling alarm is displayed after a period of time established according to water hardness. The machine is set by default for a hardness value of "4". The machine can also be programmed according to the hardness of the water supply in the various regions, so that descaling is required less often.

1. Remove the indicator paper from its packaging. If provided with your model, you will find it attached to the Quick Guide.
2. Immerse the paper completely in a glass of water for about one second.

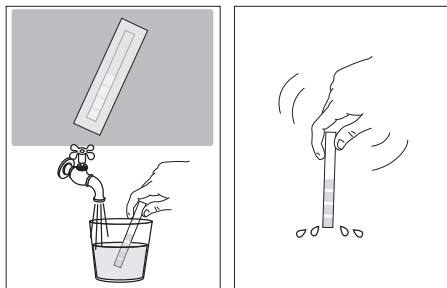

3. Remove the strip from the water and shake lightly. After about a minute, 1, 2, 3, or 4 red squares appear, depending on the hardness of the water. Each square corresponds to one level.

Total Hardness Test	Hardness
	<b>1</b> Low
	<b>2</b> Medium
	<b>3</b> Medium/High
	<b>4</b> High

See instructions in section "15. Settings menu" to set the machine.

## 13. WATER SOFTENER FILTER

To ensure constant performance of the machine over time, we recommend using a De'Longhi water softener filter.

For more information, visit the [www.delonghi.com](http://www.delonghi.com) website.

**WaterFilter** EAN: 8004399327252

To use the filter correctly, follow the instructions below.

1. Remove the filter from the packaging and turn the date indicator to view the next two months;

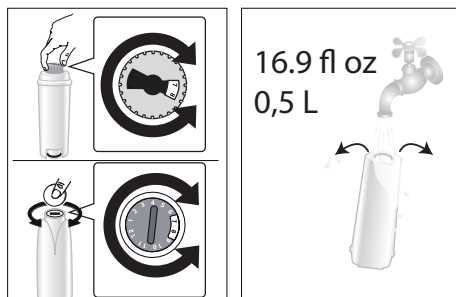

2. To activate the filter, run tap water through the hole in the center of the filter until water comes out of the openings at the side for more than a minute;
3. Extract the water tank and fill with water; insert the filter in the water tank and immerse it completely for about ten seconds, sloping it and pressing it lightly to enable the air bubbles to escape;

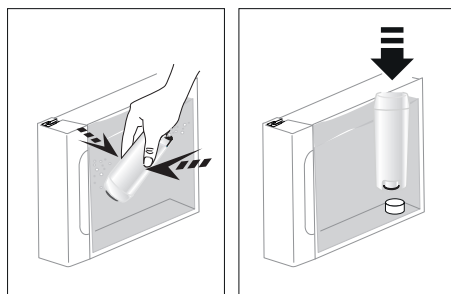

4. Insert the filter in the filter housing and press as far as it will go;
5. Close the tank with the lid, then put the tank back in the machine;

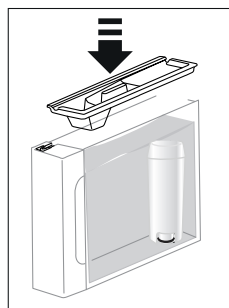

6. Place an empty container with a minimum capacity of 16.9 fl oz / 0.5 liters under the steam/hot water spout.
7. See instructions in section "15. Settings menu" to install the filter.
8. The appliance delivers hot water, then stops automatically;
9. The filter is now active and you can use the coffee machine.

### 13.1 Replacing the filter

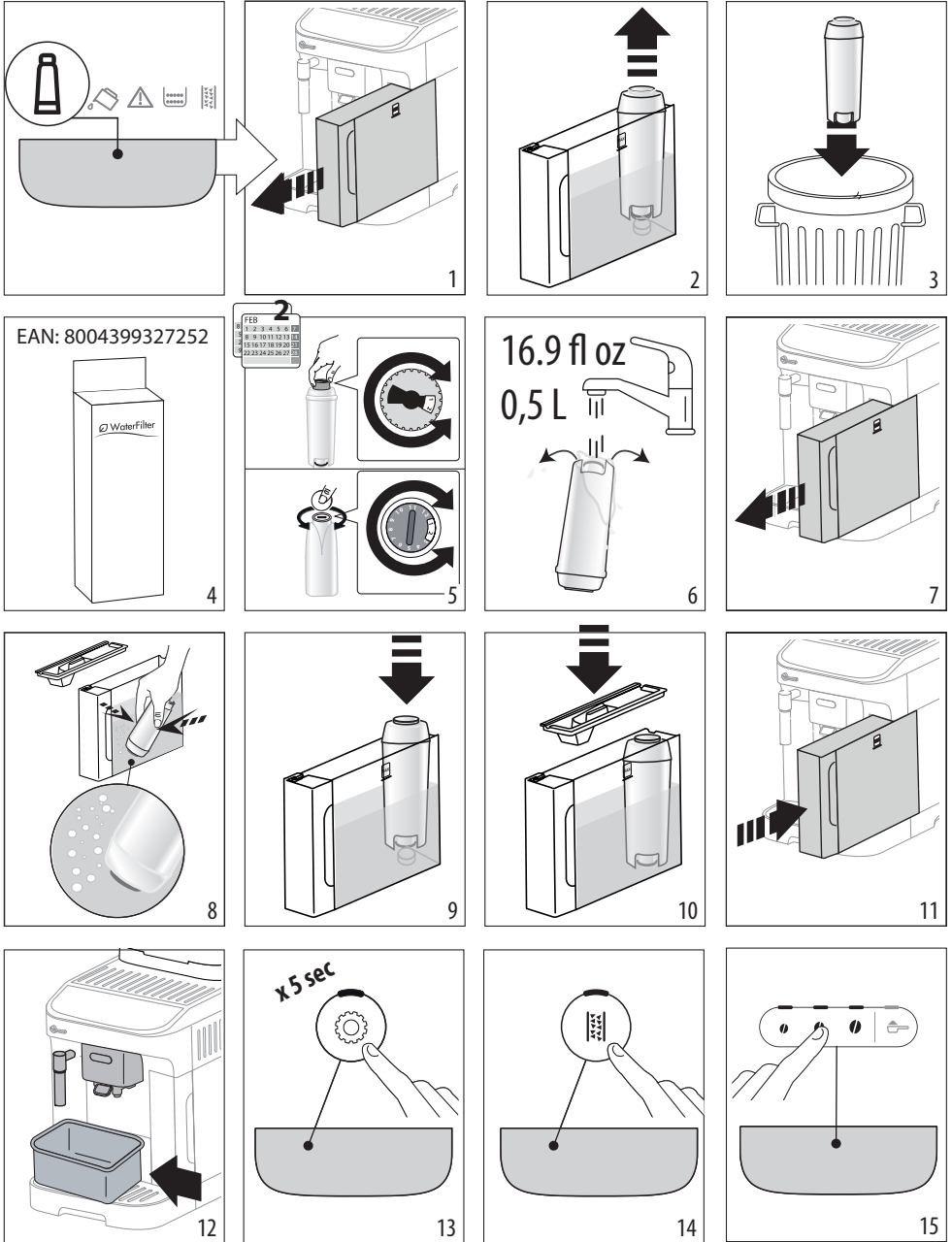

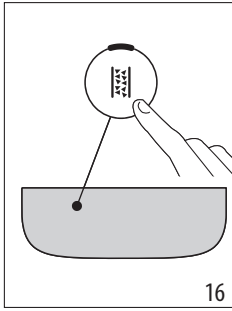

16

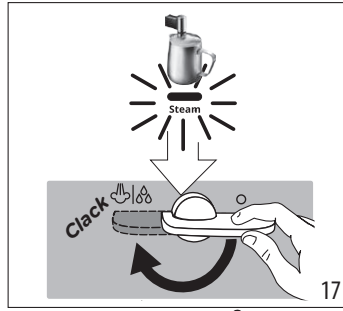

17

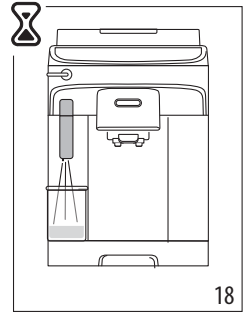

18

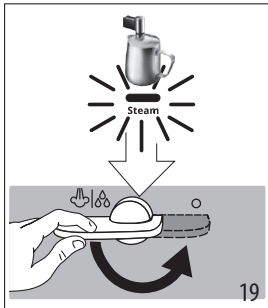

19

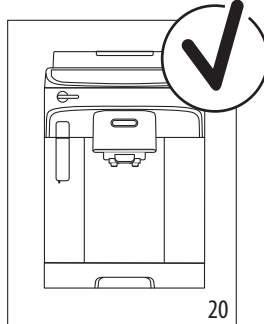

20

**Please note:**

After two months (see date indicator) or when the appliance has not been used for 3 weeks, you should replace the filter even if the message has not yet been displayed.

**13.2 Removing the filter**

If you want to use the appliance without the filter, you must remove it and notify the appliance of its removal.

1. Extract the water tank and exhausted filter;
2. See instructions in section "15. Settings menu" to set the machine.

**14. TIPS FOR ENERGY SAVING**

- Set auto-off to 15 minutes (see "15. Settings menu");
- Enable Energy Saving (see "15. Settings menu");
- Always carry out the descaling cycle when prompted by the machine.







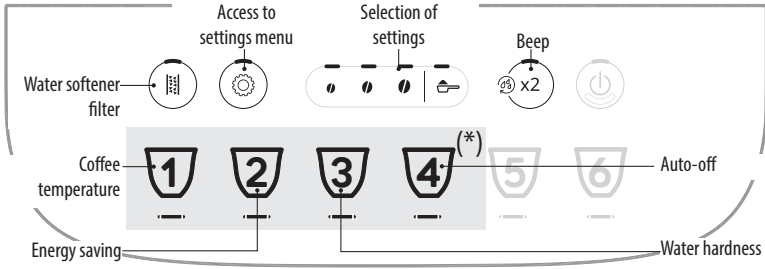























## 15. SETTINGS MENU

When in the menu, use the active buttons to select the corresponding functions:

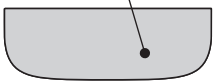

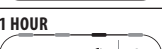

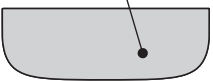
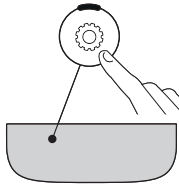
(\*) Beverages differ according to model



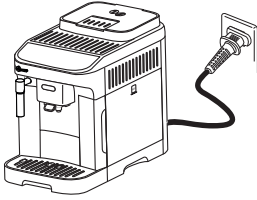

1. Access the menu:			
	<p>Press and hold the  button for 5 seconds: the settings buttons light up. Proceed by pressing the button corresponding to the setting to be adjusted.</p>		
2. Adjust the machine settings:			
<p><b>Water softener filter</b></p>	<p>Press one of the bean symbols to install or replace the water softener filter</p>	<p>INSERTED</p>	<p><b>Confirm selection</b></p>
	<p>Press the pre-ground symbol to remove the water softener filter</p>	<p>REMOVED</p>	
<p><b>Beep</b></p>	<p>Press one of the bean symbols to enable the beep</p>	<p>ON</p>	<p><b>Confirm selection</b></p>
	<p>Press the pre-ground symbol to disable the beep</p>	<p>OFF</p>	
→			

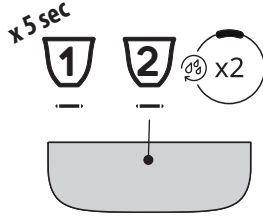
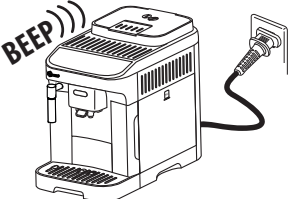
<p><b>Coffee temperature</b></p>  	<p>Press the bean symbol corresponding to the required temperature</p>	<p><b>LOW</b></p>  <p><b>MEDIUM</b></p>  <p><b>HIGH</b></p> 	<p><b>Confirm selection</b></p>  
<p><b>Energy saving</b></p>  	<p>Press one of the bean symbols to enable energy saving</p> <p>Press the pre-ground symbol to disable energy saving</p>	<p><b>ON</b></p>  <p><b>OFF</b></p> 	<p><b>Confirm selection</b></p>  
<p><b>Water hardness</b></p>  	<p>Press the symbol corresponding to the level to set</p>	<p><b>LEVEL 1</b></p>  <p><b>LEVEL 2</b></p>  <p><b>LEVEL 3</b></p>  <p><b>LEVEL 4</b></p> 	<p><b>Confirm selection</b></p>  
<p><b>Auto-off</b></p>  	<p>Press the symbol corresponding to the time to set</p>	<p><b>15 MINUTES</b></p>  <p><b>30 MINUTES</b></p>  <p><b>1 HOUR</b></p>  <p><b>3 HOURS</b></p> 	<p><b>Confirm selection</b></p>  
<p><b>3. Exit the menu:</b></p>			
	<p>Press the  button: The machine is ready for use again.</p> <p><b>Please note!</b> The machine exits the settings menu automatically if there is no activity for 30 seconds.</p>		

## 15.1 Reset default values

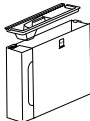
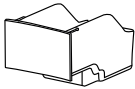
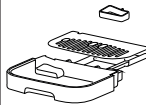



<p>Make sure the machine is in stand-by (off, but connected to the mains power supply).</p>	
<p>Press the buttons corresponding to beverages <b>1</b>, <b>2</b> and  x2 and hold for 5 seconds.</p>	
<p>The machine emits a long beep and all the lights flash to confirm the reset. All the settings and beverage quantities are reset to the default values.</p>	

## 16. CLEANING THE MACHINE

					
 50°C	✗	✗	✗	✓	✓
	✓	✓	✓	✓	✓

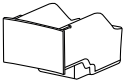
### Important!

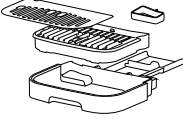
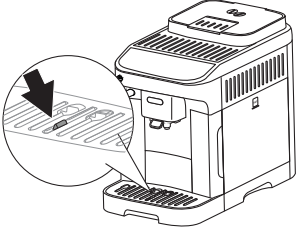
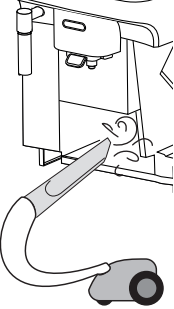
- Do not use solvents, abrasive detergents or alcohol to clean the coffee machine.
- Do not use metal objects to remove residues or coffee deposits as they could scratch metal or plastic surfaces.

Component	Frequency	Procedure
<p>Grounds container</p> 	<p>When the  light comes on, the grounds container must be emptied and the machine can no longer make coffee.</p> <p>The appliance cannot be used to make coffee until you have cleaned the grounds container. Even if not full, the empty grounds container message is displayed 72 hours after the first coffee has been prepared. For the 72 hours to be calculated correctly, the machine must never be disconnected from the mains power supply.</p>	<ul style="list-style-type: none"> <li>Remove the drip tray, empty and clean.</li> <li>Empty the grounds container and clean thoroughly to remove all residues left on the bottom.</li> <li>Check the red condensate tray and empty if necessary.</li> </ul>
<p>Drip tray components</p> 	<p>The drip tray is fitted with a level indicator (red) showing the level of water it contains.</p> <p>Before the indicator protrudes from the cup tray, the drip tray must be emptied and cleaned</p> 	<ul style="list-style-type: none"> <li>Remove the drip tray and grounds container;</li> <li>Remove the cup tray and drip tray grille, then empty the drip tray and grounds container and wash all the components;</li> <li>Check the red condensate tray and empty if necessary;</li> <li>Replace the drip tray complete with grille and the grounds container.</li> </ul> <p>When removing the drip tray, the grounds container must be emptied, even if it contains only a few grounds.</p>
<p>Inside of the machine</p> 	<p>Check periodically (about once a month) that the inside of the appliance (accessible by removing the drip tray) is not dirty.</p>	<p>Switch the machine off and disconnect from the power supply. Never immerse the machine in water.</p> <ul style="list-style-type: none"> <li>Remove coffee deposits with a brush or sponge;</li> <li>Remove all residues with a vacuum cleaner</li> </ul>
<p>Coffee spouts</p> 	<p>Clean the coffee spouts regularly (once a month)</p>	<ul style="list-style-type: none"> <li>Clean the coffee spouts regularly with a sponge or cloth;</li> <li>Check the holes in the coffee spout are not blocked. If necessary, remove coffee deposits with a toothpick.</li> </ul>

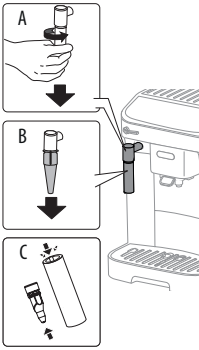

Component	Frequency	Procedure
<p>Steam wand</p> 	<p>Clean the cappuccino maker after use to avoid the build-up of milk residues or blockages.</p>	<ul style="list-style-type: none"> <li>Place a container under the cappuccino maker and deliver a little water for a few seconds by rotating the steam dial to the I position. Then turn the steam dial to the 0 position to stop the flow of hot water.</li> <li>Wait a few minutes for the steam wand to cool down. Grip the handle of the cappuccino maker tube firmly in one hand and with the other rotate the cappuccino maker anticlockwise, then remove by pulling downwards (fig. A).</li> <li>Also remove the steam nozzle by pulling it downwards (fig. B)</li> <li>Make sure the two holes shown by the arrow are not blocked. If necessary, clean with a pin (fig. C).</li> <li>Wash all parts of the cappuccino maker thoroughly with a sponge and warm water.</li> <li>Replace the nozzle and put the steam/hot water wand back on the nozzle, pushing it and turning it upwards until it is attached.</li> </ul>

## 17. CLEANING THE INFUSER

### **Important!**

The infuser cannot be extracted while the machine is on.

1. Press the  button to turn the machine off;
2. Remove the water tank;
3. Open the infuser door on the right side of the machine;

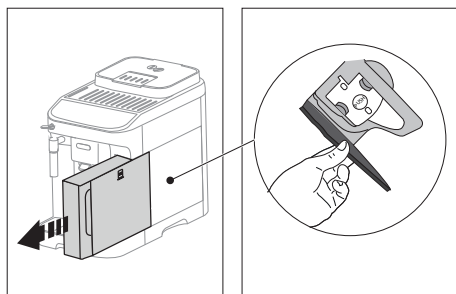

4. Press the two colored release buttons inwards, at the same time pulling the infuser outwards;

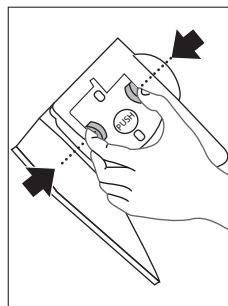

5. Soak the infuser in water for about 5 minutes, then rinse under the tap;

### **Important!**

RINSE WITH WATER ONLY

NO DETERGENTS - NO DISHWASHER

6. Do not use detergents when cleaning the infuser, as they could damage it.
7. Use the brush to remove any coffee residues left in the infuser housing, visible through the infuser door;
8. After cleaning, replace the infuser by sliding it onto the internal support, then push the PUSH symbol fully in until it clicks into place;

### **Please note:**

If the infuser is difficult to insert, before insertion, position it correctly by pressing the two levers.

## 18. DESCALING

Descal the appliance when the corresponding light  turns on. Promptly descaling the unit when required will ensure best performances and increase the lifespan of the machine.

To descale	
Descaler	De'Longhi descaler
Container	Recommended capacity: 67.62 fl oz / 2 l
Time	~45min

- Before use, read the instructions and the labelling on the descaler pack.
- Use De'Longhi descaler only. Using unsuitable descaler and/or performing descaling incorrectly may result in faults not covered by the manufacturer's guarantee.
- Descaler can cause damage to delicate surfaces. If the product is accidentally spilt, dry immediately.

### **Important:**

If the water softener filter is installed, it must be removed before adding the descaler solution.  
Put the filter back in the machine after the first tank of rinsing has been completed.

### **Please note:**

- Once the descaling cycle has begun, it cannot be interrupted and must be completed with the entire rinse cycle.
- If the descaling cycle is not completed correctly (e.g. electrical power failure), when switched on again, the machine resumes the cycle starting from the interrupted step: refer to the strength indicator lights;
- After descaling, it is normal for the grounds container to contain water.
- If the water tank has not been filled to the MAX level after descaling, the appliance prompts for a third rinse to ensure that the descaler solution has been completely eliminated from the machine's internal circuits. Before starting rinsing, remember to empty the drip tray.

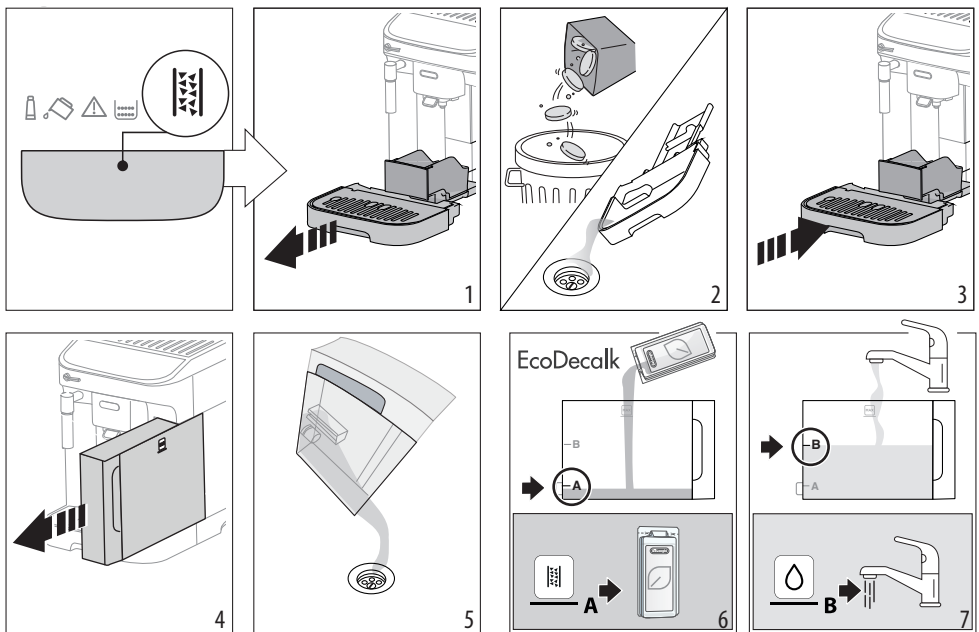

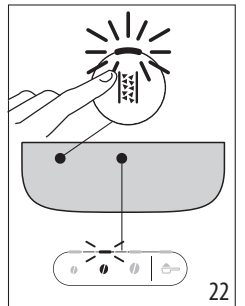
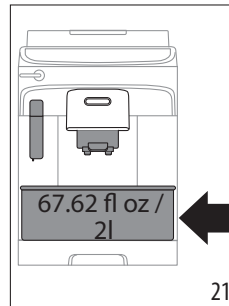
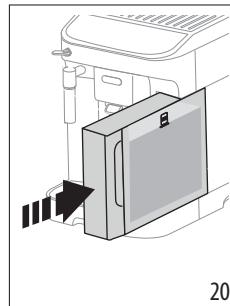
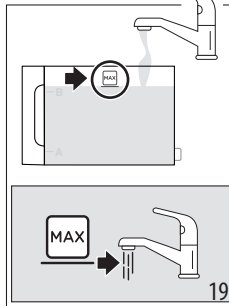
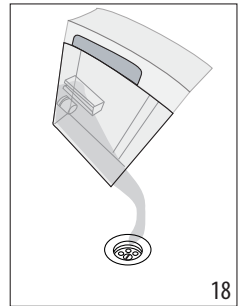
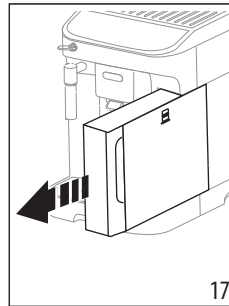
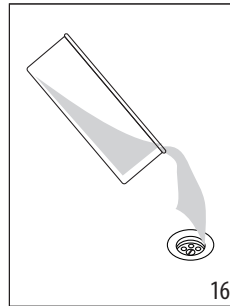
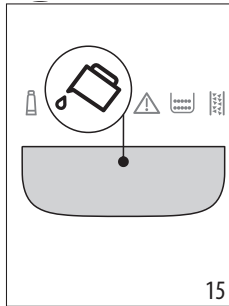
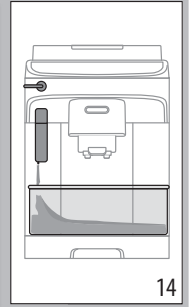
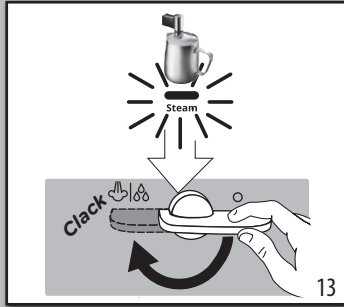
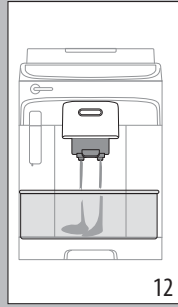
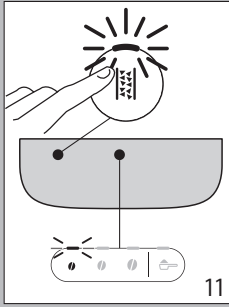
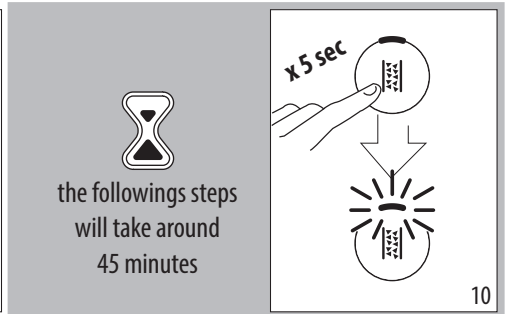
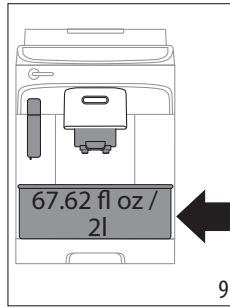
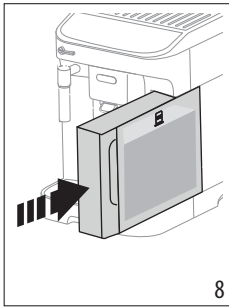

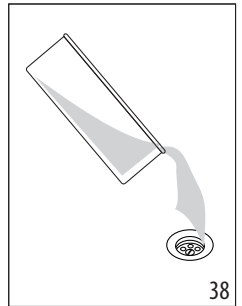
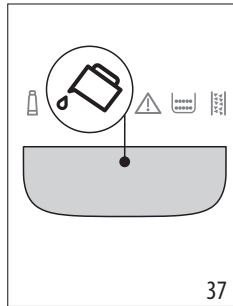
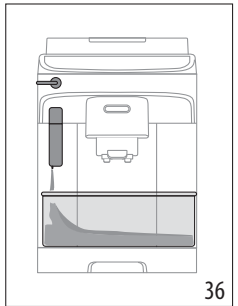
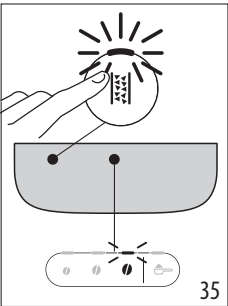
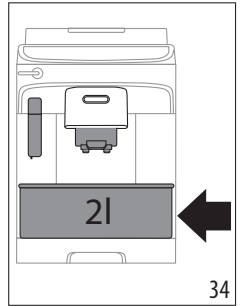
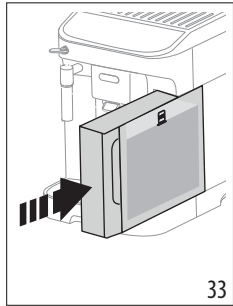
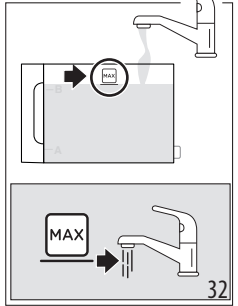
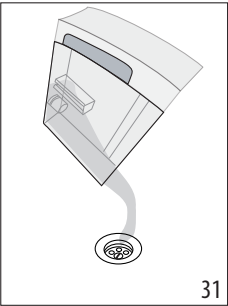
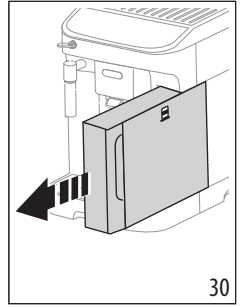
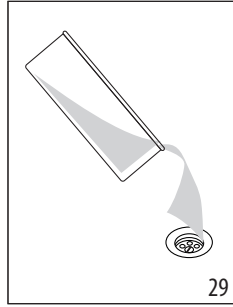
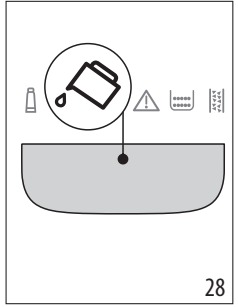
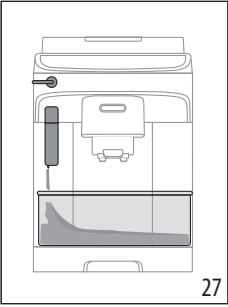
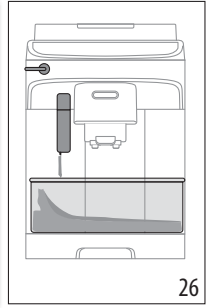
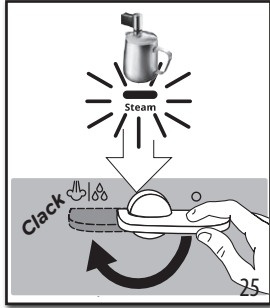
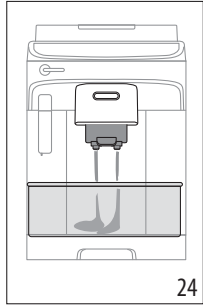
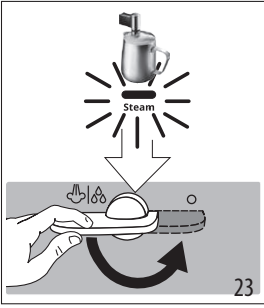



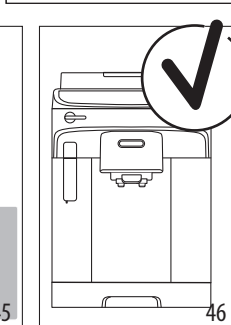
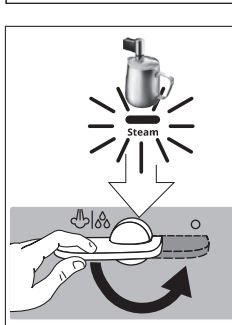
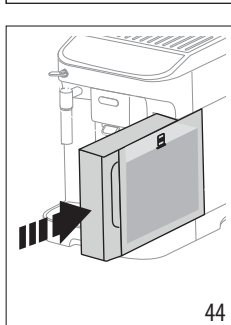
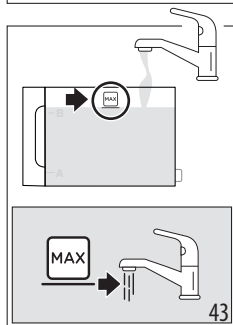
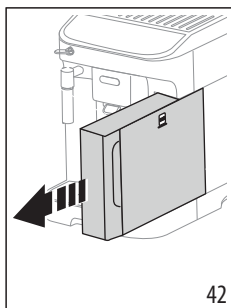
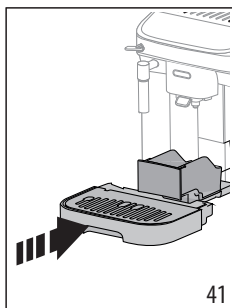
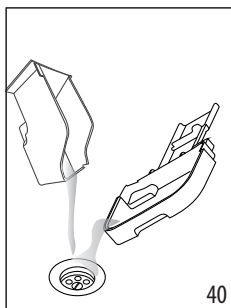
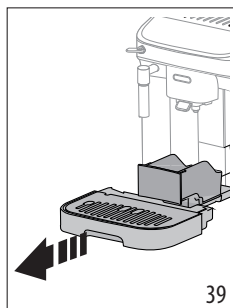



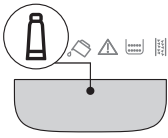
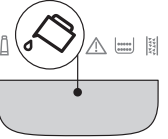

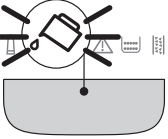

## 19. EXPLANATION OF INDICATOR LIGHTS

Light	Meaning
The beverage lights flash	The machine is warming up: wait
The beverage and settings lights are on steadily	The machine is ready for use: select the desired beverage and relative options
	Replace the filter (see section "13. Water softener filter")
	Insufficient water in tank: fill the tank
→	

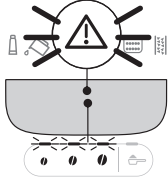
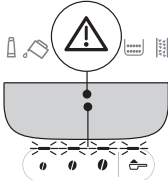
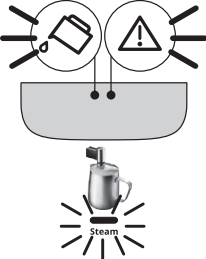
Light	Meaning
	The water tank is missing, or is not positioned correctly: insert the tank correctly
	General alarm: the inside of the machine is very dirty. Clean the machine thoroughly. If the message is still displayed after cleaning, contact De'Longhi Customer Services.
	The infuser has not been replaced after cleaning: insert the infuser as described in section "17. Cleaning the infuser"
→	

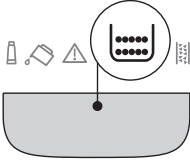
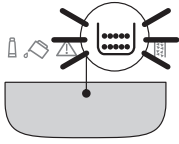
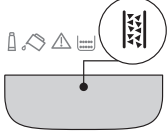
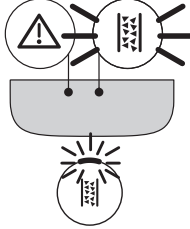

Light	Meaning
	No coffee beans: fill the beans container, then press any button to reset the alarm.
	The grinding is too fine and the coffee is delivered too slowly or not at all. Adjust the coffee grinder (section "8.6 Adjusting the coffee grinder"r")
	Too much coffee has been used. Select a milder taste or reduce the quantity of pre-ground coffee
	The water circuit is empty. Press the "Steam" button
→	

Light	Meaning
	The grounds container needs emptying
	The grounds container is missing, or not inserted correctly: insert the drip tray complete with grounds container and press as far as it will go
	Descaling is required (see section "18. Descaling")
	<p>Descaling has been interrupted. To use the machine again:</p> <ol style="list-style-type: none"> <li>1. Press the  button;</li> <li>2. If the steam dial is in the <b>0</b> position, turn it to the  position; delivery will begin and descaling will resume from Fig. 14 (see section "18. Descaling")</li> </ol>

## 20. TROUBLESHOOTING





Below is a list of some of the possible malfunctions.

If the problem cannot be resolved as described, contact customer services.

PROBLEM	POSSIBLE CAUSE	REMEDY
The appliance does not turn on.	It is not plugged into the mains socket.	Plug into the mains socket.
The coffee is not hot.	The cups were not preheated.	Warm the cups by rinsing them with hot water (Please note: you can use the hot water function).
	The internal circuits of the appliance have cooled down because 2-3 minutes have passed since the last coffee was made.	Before making coffee, press and hold the  button for 5 seconds to perform a rinse cycle and warm the internal circuits.
	Coffee temperature setting too low.	Set a hotter coffee temperature in the settings menu (see "15. Settings menu").
	The machine must be descaled	Carry out the descale procedure. Next, check the water hardness ("12. Measuring water hardness") and make certain the machine setting matches the local water supply hardness ("15. Settings menu").
The coffee is under extracted, weak or not creamy enough.	The coffee is ground too coarsely.	Adjust the grinding level ("8.6 Adjusting the coffee grinder"r"). The effect is not visible until at least 2 coffees have been made.
	The coffee is unsuitable.	Use coffee for espresso machines.
	Coffee not fresh.	The coffee pack has been opened for too long and has lost its taste.
The coffee is delivered too slowly or drop by drop (over extracted).	The coffee is ground too finely.	Adjust the grinding level ("8.6 Adjusting the coffee grinder"r"). The effect is not visible until at least 2 coffees have been made.
The machine does not make coffee	Impurities have been detected in the internal circuits	Wait until the machine is ready for use again, and proceed to select the required beverage. Contact customer services if the problem persists.
Coffee does not come out of one or both spouts.	The coffee nozzles are blocked.	Clean the nozzles with a cloth. Any residues can be removed with a toothpick, if necessary.
The coffee delivered is watery.	The pre-ground coffee funnel is clogged.	Open the door and clean the funnel with the help of a brush.
The infuser cannot be extracted.	The machine has not been turned off.	Turn the machine off by pressing the  button.
At the end of descaling, the appliance requests a third rinse	Water tank not filled to the MAX level during the course of the two rinse cycles	Empty the drip tray, fill the tank up to the MAX level and run the third rinse cycle.
		→

<b>PROBLEM</b>	<b>POSSIBLE CAUSE</b>	<b>REMEDY</b>
The frothed milk has big bubbles	The milk is not cold enough.	Use milk at refrigerator temperature (about 41°F/ 5° C). See section “11. making cappuccino  ” for more details.
	Steam wand dirty.	Remove the components and clean them thoroughly.
	Plant based alternative milk has been used.	The effect varies widely depending on the nutritional properties of the milk.
The cup tray on top of the machine is hot	A number of beverages have been prepared in rapid succession	
The machine emits noises or small puffs of steam while not in use	The machine is ready for use, or has recently been turned off, and condensate is dripping into the hot vaporiser.	This is part of normal operation. To limit this from happening, empty the drip tray.
The appliance emits puffs of steam from the drip tray and/or there is water on the surface the appliance rests on.	The drip tray grille has not been replaced after cleaning.	Put the drip tray grille back in the drip tray.

## CONTENU

<b>1. CONSIGNES POUR LA SÉCURITÉ</b> .....	31
<b>2. INFORMATIONS GÉNÉRALES</b> .....	31
2.1 Mode d'emploi .....	31
<b>3. OPÉRATIONS PRÉLIMINAIRES</b> .....	31
3.1 Contrôle de l'appareil .....	31
3.2 Installation de l'appareil.....	31
3.3 Branchement de l'appareil .....	31
<b>4. INTRODUCTION</b> .....	32
<b>5. DESCRIPTION</b> .....	32
5.1 Description de l'appareil - A.....	32
5.2 Description du panneau de contrôle- B.	32
5.3 Description des accessoires - C* .....	32
5.4 Première mise en marche de la machine	32
5.5 Nettoyage et entretien des matériaux en contact avec les aliments .....	32
<b>6. À LA PREMIÈRE UTILISATION</b> .....	33
<b>7. ALLUMAGE ET ARRÊT</b> .....	34
<b>8. DISTRIBUTION DE BOISSONS À BASE DE CAFÉ</b> .....	34
8.1 Préparer 1 tasse de café avec des grains de café .....	34
8.2 Préparer 2 tasses de café avec des grains de café .....	35
8.3 Variation de l'arôme du café.....	35
8.4 Rinçage .....	35
8.5 Conseils pour un café plus chaud.....	35
8.6 Réglage du moulin à café.....	35
8.7 Personnaliser la quantité en tasse.....	36
8.8 Préparation du café en utilisant le café pré-moulu .....	36
<b>9. PRÉPARATION DU OVER ICE</b>  .....	37
<b>10. DISTRIBUTION D'EAU CHAUDE</b>  .....	37
<b>11. PRÉPARATION DU CAPPUCINO</b>  .....	38
<b>12. MESURE DE LA DURETÉ DE L'EAU</b> .....	39
<b>13. FILTRE ADOUCISSEUR</b> .....	39
13.1 Remplacement du filtre .....	40
13.2 Retrait du filtre.....	41
<b>14. CONSEILS POUR L'ÉCONOMIE D'ÉNERGIE</b> .	41
<b>15. MENU PARAMÈTRES</b> .....	42
15.1 Réinitialisation des valeurs d'usine ....	44
<b>16. NETTOYAGE DE L'APPAREIL</b>  .....	44
<b>17. NETTOYAGE DE L'INFUSEUR</b> .....	46
<b>18. DÉTARTRAGE</b>  .....	47
<b>19. SIGNIFICATION DES VOYANTS</b> .....	51
<b>20. TROUBLESHOOTING</b> .....	52

# AVERTISSEMENTS IMPORTANTS

Lors de l'utilisation des appareils électriques, vous devez toujours respecter des précautions de base, et notamment les suivantes.

- Lisez attentivement toutes les instructions.
- Assurez-vous que la tension de votre système électrique correspond à la tension indiquée sur le fond de la machine.
- Ne touchez pas les surfaces chaudes. Utilisez les poignées ou les boutons.
- Pour vous protéger contre l'incendie, les électrocutions et les blessures, ne plongez pas le cordon, la fiche ou l'appareil dans l'eau ou tout autre liquide.
- Conservez l'appareil hors de portée des enfants et ne laissez pas l'appareil sans surveillance lorsqu'il est en marche.
- Débranchez-le de la prise lorsqu'il n'est pas utilisé et avant le nettoyage.
- N'utilisez pas l'appareil avec un cordon ou une fiche endommagés, si l'appareil présente un dysfonctionnement ou s'il a subi des dégâts. Renvoyez l'appareil au centre assistance autorisé le plus proche pour un examen, une réparation ou un ajustement.
- L'utilisation d'accessoires non recommandés par le fabricant peut provoquer un incendie, une électrocution ou des blessures.
- N'utilisez pas l'appareil à l'extérieur.
- Assurez-vous que le cordon d'alimentation ne pende pas du bord de la table ou du plan de travail afin d'éviter tout enchevêtrement.
- Ne placez pas l'appareil ou ses parties électriques au-dessus ou à proximité des cuisinières électriques, surfaces de cuisson ou brûleurs à gaz.
- Branchez le cordon dans la prise murale. Pour le débrancher, mettez d'abord la machine hors tension, puis retirez la fiche de la prise murale.
- N'utilisez pas l'appareil pour d'autres usages que ceux qui sont prévus. Cet appareil doit être utilisé dans un milieu domestique uniquement. Le fabricant décline toute responsabilité quant aux dégâts causés par une utilisation impropre, incorrecte ou irresponsable.

**AVERTISSEMENT : Afin de réduire le risque d'incendie ou d'électrocution, ne retirez pas le capot ou l'extérieur de l'unité. Ne tentez aucune réparation ou modification de la machine sous peine d'annuler la garantie. Les réparations doivent être effectuées exclusivement par du personnel d'assistance autorisé.**

## CONSERVEZ CES INSTRUCTIONS

CET APPAREIL DOIT ÊTRE UTILISÉ DANS UN MILIEU DOMESTIQUE UNIQUEMENT

## INSTRUCTIONS POUR LE CORDON COURT

- Un cordon d'alimentation court est fourni pour réduire les risques d'enchevêtrement ou de trébuchement sur un cordon plus long.
- Des cordons d'alimentation plus longs et amovibles ou des rallonges sont disponibles et peuvent être utilisées à condition de prendre des précautions.
- En cas d'utilisation d'une rallonge, les caractéristiques électriques indiquées doivent être au moins égales à celles de l'appareil. Si l'appareil est doté d'un cordon à 3 fils avec mise à la terre, la rallonge doit être un

**CORDON À 3 FILS AVEC MISE À LA TERRE.** Le cordon plus long doit être disposé de sorte qu'il ne pende pas du plan de travail ou de la table afin d'éviter que les enfants tirent dessus ou qu'il provoque un trébuchement.

## 1. CONSIGNES POUR LA SÉCURITÉ

### **Attention!**

Étant donné que l'appareil fonctionne à l'électricité, il n'est pas à exclure qu'il génère des décharges électriques.

Par conséquent, respecter les consignes de sécurité suivantes :

- Ne pas toucher l'appareil avec les mains ou les pieds mouillés.
- Ne pas toucher la fiche avec les mains mouillées.
- S'assurer que la prise de courant utilisée soit toujours librement accessible, afin de garantir le débranchement en cas de besoin.
- Pour débrancher la fiche de la prise, agir directement sur la fiche. Ne jamais tirer le cordon, il pourrait s'abîmer.
- Pour débrancher complètement l'appareil, retirer la fiche de la prise de courant.
- En cas de pannes de l'appareil, ne pas tenter de les réparer. Éteindre l'appareil, retirer la fiche de la prise et s'adresser à l'Assistance Technique.
- Avant de réaliser une quelconque opération de nettoyage, éteindre la machine, retirer la fiche de la prise de courant et laisser refroidir la machine.

### **Attention!**

Conserver le matériel d'emballage (sachets en plastique, polystyrène expansé) hors de la portée des enfants.

**RISQUE D'ÉTOUFFEMENT :** l'appareil pourrait contenir de petites pièces. Durant les opérations de nettoyage et d'entretien, certaines de ces pièces pourraient être démontées. Manipuler les petites pièces avec soin et les tenir hors de portée des enfants.

### **Risque de brûlures !**

Cet appareil produit de l'eau chaude et, quand il est en marche, de la vapeur d'eau peut se former.

**Durant le fonctionnement (rinçage automatique, distributions de boissons chaudes, distribution de vapeur, opérations de nettoyage), prêter attention à ne pas venir en contact avec les éclaboussures d'eau chaude ou la vapeur.**

Quand l'appareil est en marche, le plateau d'appui des tasses pourrait chauffer.

## 2. INFORMATIONS GÉNÉRALES

### 2.1 Mode d'emploi

Lire attentivement toutes les instructions avant d'utiliser l'appareil. Le non-respect de ces instructions peut causer des blessures et des dommages à l'appareil.

Le constructeur ne répond pas des dommages découlant du non-respect de ce mode d'emploi.

### **Nota Bene :**

**Ces consignes de sécurité sont valables pour toutes les machines à café De'Longhi.**

**Conserver soigneusement cette notice ainsi que les instructions fournies avec l'appareil.**

En cas de cession de l'appareil à d'autres personnes, leur remettre également ce mode d'emploi.

## 3. OPÉRATIONS PRÉLIMINAIRES

### 3.1 Contrôle de l'appareil

Après avoir retiré l'emballage, s'assurer de l'intégrité de l'appareil et de la présence de tous les accessoires. Ne pas utiliser l'appareil en présence de dommages évidents. S'adresser à l'Assistance Technique De'Longhi.

### 3.2 Installation de l'appareil

Lors de l'installation de l'appareil, respecter les consignes de sécurité suivantes :

- L'appareil émet de la chaleur dans son environnement. Après avoir positionné l'appareil sur le plan de travail, vérifier qu'il reste au moins 3 cm entre les surfaces de l'appareil, les parties latérales et la partie arrière et un espace libre d'au moins 15 cm au-dessus de la machine à café.
- L'éventuelle pénétration d'eau dans l'appareil pourrait l'endommager. Ne pas placer l'appareil à proximité de robinets d'eau ou d'éviers.
- L'appareil pourrait s'abîmer si l'eau gèle à l'intérieur. Ne pas installer l'appareil dans un lieu où la température peut descendre en dessous du point de congélation.
- Positionner le cordon d'alimentation afin qu'il ne soit pas abîmé par des arêtes tranchantes ou par le contact avec des surfaces chaudes (par ex. plaques électriques).

### 3.3 Branchement de l'appareil

S'assurer que la tension du secteur corresponde à celle indiquée sur la plaquette située au-dessous de l'appareil.

Brancher l'appareil uniquement à une prise de courant installée dans les règles de l'art, ayant une intensité minimum de 10A et munie d'une mise à la terre efficace.

En cas d'incompatibilité entre la prise et la fiche de l'appareil, faire remplacer par un autre type plus approprié, par un personnel qualifié.

### 3.4 Première mise en marche de la machine

À la première utilisation le circuit d'eau est vide, c'est pourquoi la machine pourrait être très bruyante : le bruit s'atténuera au fur et à mesure que le circuit se remplira.

### 3.5 Nettoyage et entretien des matériaux en contact avec les aliments

- À la première utilisation, ou après 3 ou 4 jours d'inutilisation, nettoyer l'appareil et les accessoires amovibles,

destinés à entrer en contact avec l'eau, le café et le lait, comme prévu par le mode d'emploi. Vérifier sur la notice quels sont les accessoires lavables au lave-vaisselle.

- Après 3 ou 4 jours d'inutilisation on conseille de rincer le circuit avant de préparer la première boisson, comme décrit dans les instructions.
- Il est recommandé d'effectuer scrupuleusement toutes les opérations de nettoyage et d'entretien décrites dans le mode d'emploi et/ou proposées par l'écran ou les voyants lumineux de l'appareil.

### 3.6 Préparation de boissons lactées





- La machine a été testée pour fonctionner avec du lait de vache et les produits d'origine végétale suivants : soja, riz et almond. Tout autre type de lait ou de produits d'origine végétale ne peut être utilisé.
- En cas d'utilisation de laits autres que le lait de vache, nettoyer le système en suivant les mêmes procédures standards décrites dans la notice d'instructions.
- Les systèmes de nettoyages autorisés par le constructeur et indiqués dans le mode d'emploi ne garantissent pas l'élimination complète des allergènes.
- Dans le cas d'allergies et d'intolérances confirmées ou suspectées, assurez-vous que votre machine n'a pas été précédemment utilisée avec du lait ou un produit d'origine végétale contenant les allergènes que vous êtes allergique ou les substances dont vous êtes intolérants.

## 4. INTRODUCTION

Les principales opérations de la machine sont illustrées pas à pas dans le Quick Guide.

Prenez quelques minutes pour lire ce mode d'emploi. Vous éviterez ainsi de vous exposer à des risques ou d'endommager la machine.

Les leds et les voyants sur le panneau de votre machine vous aideront à interagir correctement avec la machine :

	Éteint	--
	Allumé	Fonction disponible
	Clignotant	Fonction en cours
	Clignotant rapide	L'appareil requiert l'intervention de l'utilisateur

## 5. DESCRIPTION

### 5.1 Description de l'appareil - A

- A1. Bac à grains
- A2. Couvercle de l'entonnoir pour le café prémoulu
- A3. Couvercle du bac à grains
- A4. Bouton de réglage de mouture
- A5. Entonnoir pour le café prémoulu
- A6. Manette vapeur/eau chaude
- A7. Buse en caoutchouc
- A8. Buse à cappuccino
- A9. Écoulement du café (réglable en hauteur)
- A10. Collecteur de condensat
- A11. Bac à marc
- A12. Repose-tasse
- A13. Indicateur du niveau d'eau pour le plateau d'égouttement
- A14. Grille du plateau d'égouttement
- A15. Plateau d'égouttement
- A16. Couvercle du réservoir d'eau
- A17. Réservoir d'eau
- A18. Boîtier du filtre à eau
- A19. Cordon d'alimentation
- A20. Porte de l'unité d'infusion
- A21. Unité d'infusion

### 5.2 Description du panneau de contrôle- B

- B1. Touche ON/Standby button avec LED
- B2. Touche X2 avec LED (maintenir enfoncée la touche pendant environ 5 secondes pour le rinçage)
- B3. Recettes directes avec LED (\*Le type et le nombre de boissons diffèrent suivant le modèle.)
- B4. Touche menu paramètres avec LED
- B5. Touche détartrage avec LED
- B6. Sélection de l'arôme du café et du prêt-moulu
- B7. Voyant de filtre à eau épuisé
- B8. LED allumée en continu: manque d'eau dans le réservoir (A17)  
LED clignotant: le réservoir n'est pas inséré
- B9. Alarme générale avec LED
- B10. LED allumée en continu: le bac à marc (A11)  
LED clignotant: remettre le bac à marc en place
- B11. Voyant de détartrage

### 5.3 Description des accessoires - C\*

- C1. Bande réactive "Total Hardness Test"
- C2. Cuillère-doseur pour café prémoulu
- C3. Détartrant
- C4. Filtre adoucisseur



## 6. À LA PREMIÈRE UTILISATION

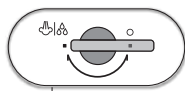
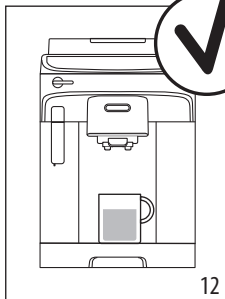
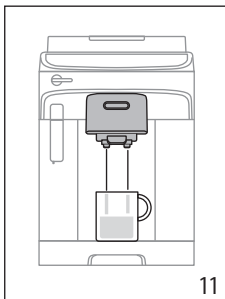
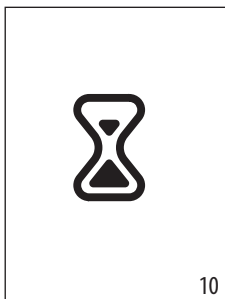
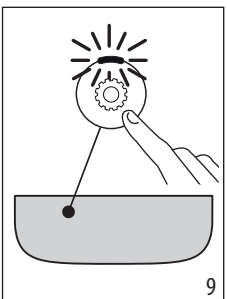
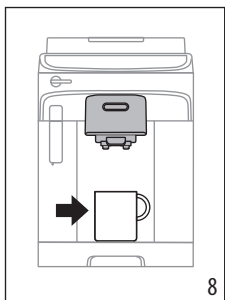
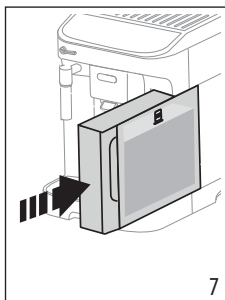
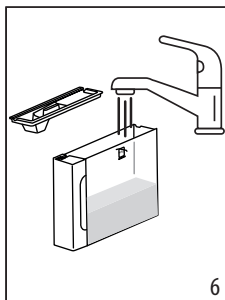
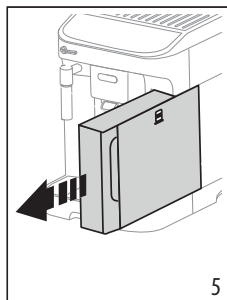
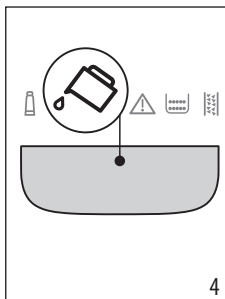
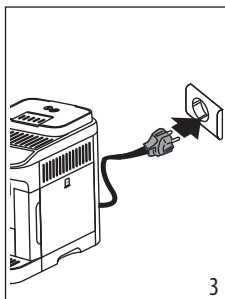
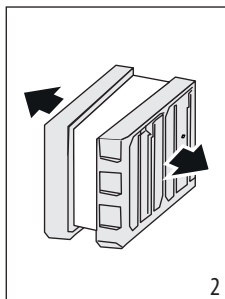
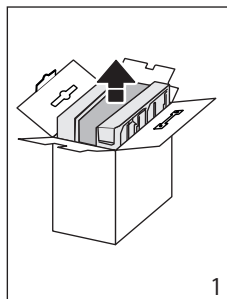

S'assurer que la manette vapeur soit sur 0

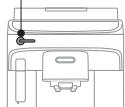

- À la première utilisation de la machine, il faut faire 4-5 cappuccinos avant d'obtenir un résultat satisfaisant en tasse.
- À la première utilisation le circuit d'eau est vide, c'est pourquoi la machine pourrait être très bruyante : le bruit s'atténuera au fur et à mesure que le circuit se remplira.
- Les traces dans le moulin à café sont dues aux tests de paramétrage de la machine avant la mise en commerce et démontrent l'attention particulière que nous avons pour nos produits.

## 7. ALLUMAGE ET ARRÊT

- À chaque allumage, l'appareil effectue automatiquement un cycle de préchauffage et de rinçage qui ne peut pas être interrompu. L'appareil est prêt à l'emploi uniquement après l'exécution de ce cycle.
- À chaque arrêt, l'appareil effectue un rinçage automatique, à condition qu'un café ait été préparé.

### **Risque de brûlures !**

Durant le rinçage, un peu d'eau chaude coule des bords verseurs de la buse à café. Veiller à ne pas entrer en contact avec les éclaboussures d'eau.

- Pour allumer ou éteindre l'appareil, appuyer sur la touche .

Si l'appareil n'est pas utilisé pendant des périodes prolongées, débrancher l'appareil du secteur.

## 8. DISTRIBUTION DE BOISSONS À BASE DE CAFÉ

### 8.1 Préparer 1 tasse de café avec des grains de café

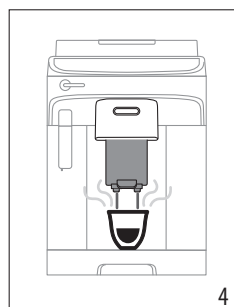
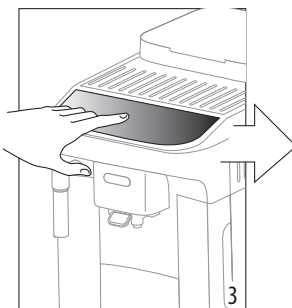
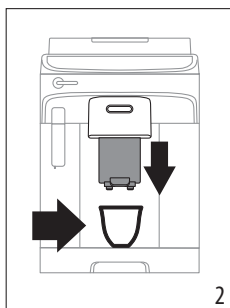
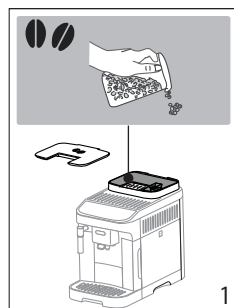

(\*)



### **Nota bene**

- Ne pas utiliser des grains de café verts, caramélisés ou confits, car ils peuvent se coller sur le moulin à café et le rendre inutilisable.
- Si le mode « Économie d'énergie » est activé, la distribution du premier café pourrait demander quelques secondes d'attente.

## 8.2 Préparer 2 tasses de café avec des grains de café

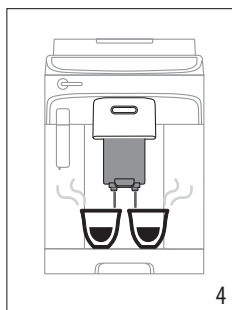
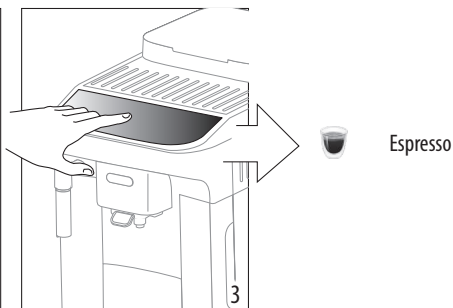
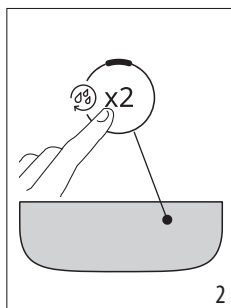
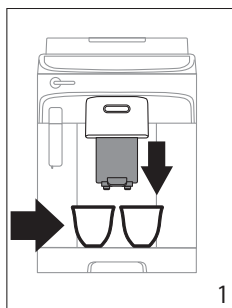

### Nota bene

- Ne pas utiliser des grains de café verts, caramélisés ou confits, car ils peuvent se coller sur le moulin à café et le rendre inutilisable.
- Si le mode « Économie d'énergie » est activé, la distribution du premier café pourrait demander quelques secondes d'attente.

## 8.3 Variation de l'arôme du café

1. Appuyer sur la touche relative à l'arôme souhaité :

	Léger
	Moyen
	Fort

2. Sélectionner la boisson à base de café souhaitée.

### Nota bene :

- Lors de la préparation suivante, la machine propose le dernier arôme sélectionné.
- En cas de coupure du courant, la machine repasse au niveau moyen par défaut.

## 8.4 Rinçage

Cette fonction permet de faire sortir de l'eau chaude par le bec verseur de café, de façon à nettoyer et chauffer le circuit interne de la machine.

Pour lancer le rinçage, il suffit de maintenir enfoncée la touche  pendant environ 5 secondes : la distribution s'interrompt automatiquement (si l'on souhaite interrompre avant, appuyer à nouveau sur la même touche).

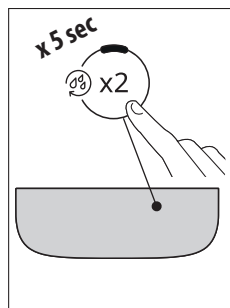

## 8.5 Conseils pour un café plus chaud



Pour obtenir un café plus chaud, il est conseillé de :

- effectuer un rinçage (voir paragraphe "8.4 Rinsing");
- chauffer les tasses avec de l'eau chaude en utilisant la fonction eau chaude ;
- augmenter la température du café (voir chapitre "15. Settings menu").

## 8.6 Réglage du moulin à café

Le moulin à café ne doit pas être réglé, du moins au début, car il a été déjà préréglé en usine pour obtenir une distribution correcte de café.

Pour effectuer une correction, durant le fonctionnement du moulin à café, régler le bouton comme suit :





<p>Si le café sort trop lentement ou ne sort pas du tout. L'effet de cette correction se remarque uniquement après la préparation d'au moins 2 cafés.</p>	<p>Tourner d'un cran vers le numéro 7</p> 
<p>Pour une distribution du café plus dense et améliorer l'aspect de la crème L'effet de cette correction se remarque uniquement après la préparation d'au moins 2 cafés.</p>	<p>Tourner d'un cran vers le numéro 1</p> 

**Nota Bene :**

Le bouton de réglage doit être tourné uniquement pendant que le moulin est en marche durant la phase initiale de préparation des boissons à base de café.

**8.7 Personnaliser la quantité en tasse**

1. Maintenir enfoncée pendant quelques secondes la touche correspondante à la boisson à programmer : on est dans le menu programmation lorsque le voyant clignote rapidement. La distribution commence ;
2. Après avoir atteint la quantité souhaitée dans la tasse, presser à nouveau la touche de la boisson : la distribution s'interrompt et la quantité est mémorisée.

Boisson*		Par défaut (fl oz / ml)	Programmable (fl oz / ml)
	Espresso	1.35 / 40	de ≈ 0.68 / 20 à ≈ 6.08 / 180
	Coffee	6.08 / 180	de ≈ 3.38 / 100 à ≈ 8.11 / 240
	Long	5.41 / 160	de ≈ 3.89 / 115 à ≈ 8.45 / 250
	Doppio+	4.05 / 120	de ≈ 2.70 / 80 à ≈ 6.08 / 180
	Over ice	3.38 / 100	de ≈ 1.35 / 40 à ≈ 8.11 / 240

(\*) Le type et le nombre de boissons diffèrent suivant le modèle.

**Nota Bene !**

Pour annuler la programmation en cours, appuyer sur une touche relative à une autre boisson.

**8.8 Préparation du café en utilisant le café pré-moulu**

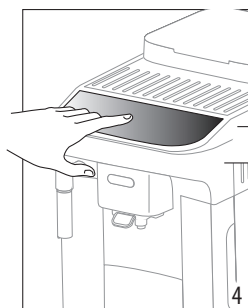
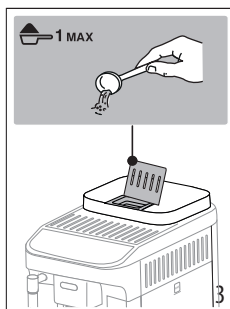
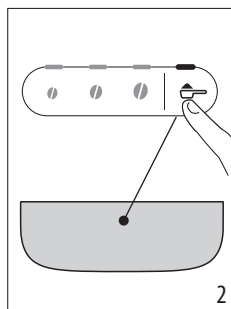
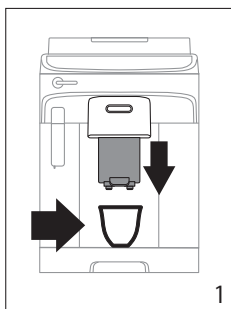



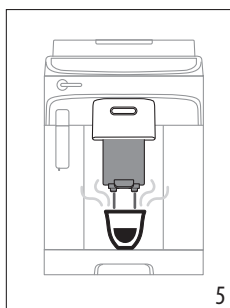

(\*)

-  Espresso
-  Coffee
-  Long



**Nota bene:**

- Ne jamais introduire le café pré-moulu avec la machine éteinte, pour éviter qu'il ne se répande à l'intérieur de la machine et qu'il ne la salisse. Dans ce cas, la machine pourrait s'abîmer.
- Ne jamais introduire plus d'une dose rase, l'intérieur de la machine pourrait se salir ou l'entonnoir pourrait se boucher.
- En préparant le café  **Long** : au milieu de la préparation, lorsque les voyants  +  s'allument, verser une autre dose rase de café pré-moulu et appuyer à nouveau sur la touche Long.
- Il n'est pas possible de préparer le café  **Doppio+** en utilisant le café pré-moulu.

## 9. PRÉPARATION DU OVER ICE

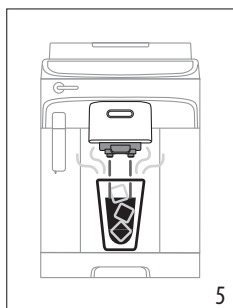
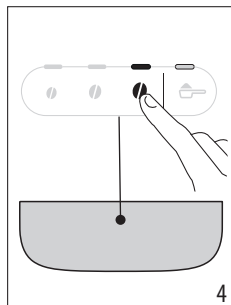
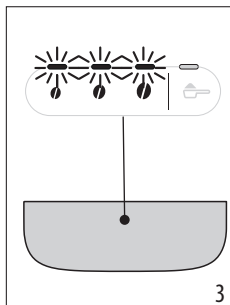
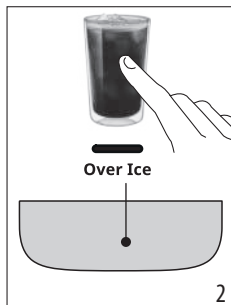
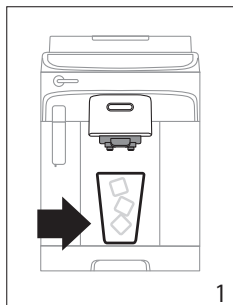

### *Nota bene:*

- Un arôme fort est recommandé
- Utilisez toujours des verres résistants aux chocs thermiques.

## 10. DISTRIBUTION D'EAU CHAUDE

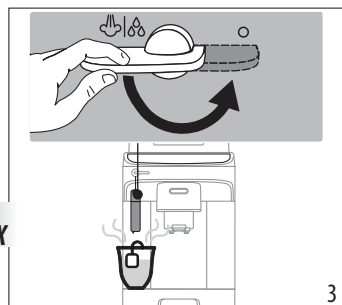
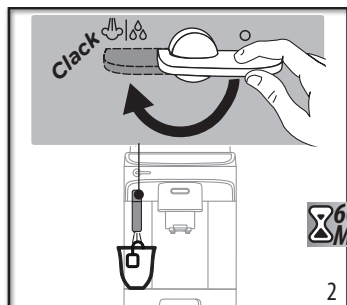
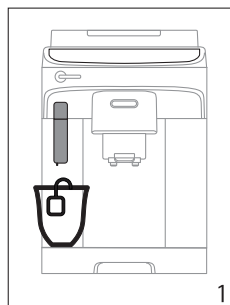

## 11. PRÉPARATION DU CAPPUCCINO

- Remplir un récipient avec environ 3.38 Fl oz / 100 ml de lait pour chaque cappuccino que l'on souhaite préparer. Dans le choix des dimensions du récipient, prendre en compte que le volume augmentera de 2 à 3 fois.
- Pour obtenir une mousse plus dense et riche, utiliser du lait écrémé ou demi-écrémé et à la température du réfrigérateur (environ 41°F/5°C). Pour éviter d'obtenir un lait peu mousseux, ou avec de grosses bulles, toujours nettoyer la buse à cappuccino après chaque utilisation.
- La qualité de la mousse peut varier en fonction de :
  - type de lait ou boisson végétale ;
  - marque utilisée ;
  - ingrédients et valeurs nutritionnelles.



## 12. MESURE DE LA DURETÉ DE L'EAU

L'alarme détartrage s'affiche après une période de fonctionnement prédéfinie qui dépend de la dureté de l'eau. La machine est préconfigurée en usine sur le « Niveau 4 » de dureté. Il est possible de programmer la machine en fonction de la dureté réelle de l'eau courante dans les différentes régions, rendant ainsi l'opération de détartrage moins fréquente.

1. Retirer la bande réactive de son emballage : si votre modèle en est pourvu, vous la trouverez jointe au Quick Guide.
2. Plonger entièrement la bande réactive dans un verre d'eau pendant environ une seconde.

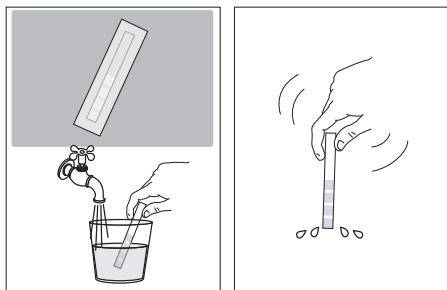

3. Extraire la bande de l'eau et la secouer légèrement. Après une minute, 1, 2, 3 ou 4 petits carrés rouges se forment, en fonction de la dureté de l'eau ; chaque petit carré correspond à 1 niveau.

Total Hardness Test	Niveau de dureté
	<b>1</b> Basse
	<b>2</b> Moyenne
	<b>3</b> Moyenne/Haute
	<b>4</b> Haute

Voir les instructions du chapitre "15. Settings menu" pour programmer la machine.

## 13. FILTRE ADOUCISSEUR

Pour maintenir les performances de la machine constantes dans le temps, il est conseillé d'utiliser le filtre adoucisseur De'Longhi.

Pour de plus amples informations consulter le site [www.de-longhi.com](http://www.de-longhi.com).

WaterFilter EAN : 8004399327252

Pour une utilisation correcte du filtre, suivre les instructions indiquées ci-après.

1. Retirer le filtre de son emballage et tourner le dateur jusqu'à afficher les 2 prochains mois ;

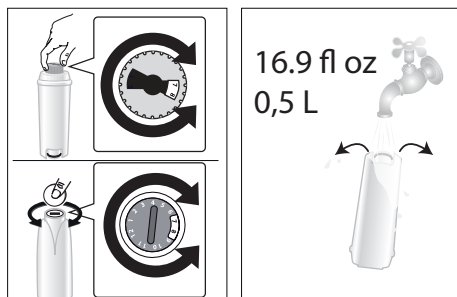

2. Pour activer le filtre, faire couler de l'eau du robinet dans l'orifice central du filtre jusqu'à ce que l'eau sorte par les ouvertures latérales pendant plus d'une minute ;
3. Extraire le réservoir d'eau de la machine et le remplir d'eau ; insérer le filtre dans le réservoir d'eau et le plonger complètement pendant une dizaine de secondes, en l'inclinant et en appuyant dessus légèrement pour permettre aux bulles d'air de sortir ;

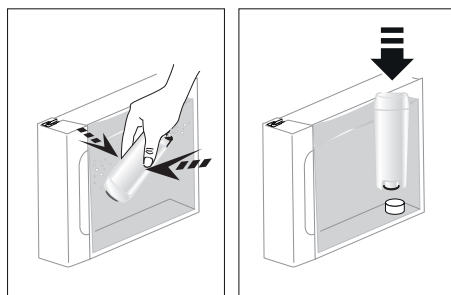

4. Insérer le filtre dans son logement prédéfini et le presser à fond ;
5. Rfermer le réservoir à l'aide du couvercle, puis réinsérer le réservoir dans la machine ;

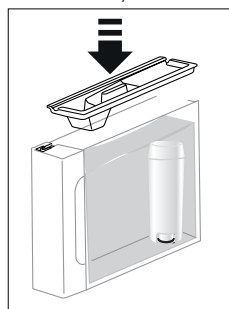

6. Placer un récipient vide ayant une capacité minimale de 16.9 fl oz / 0.5 litres sous la buse à vapeur/eau chaude.
7. Voir les instructions du chapitre "15. Settings menu" pour installer le filtre.
8. L'appareil fait couler de l'eau chaude et s'interrompt automatiquement ;
9. Le filtre est maintenant actif et il est possible de continuer à utiliser la machine.

### 13.1 Remplacement du filtre

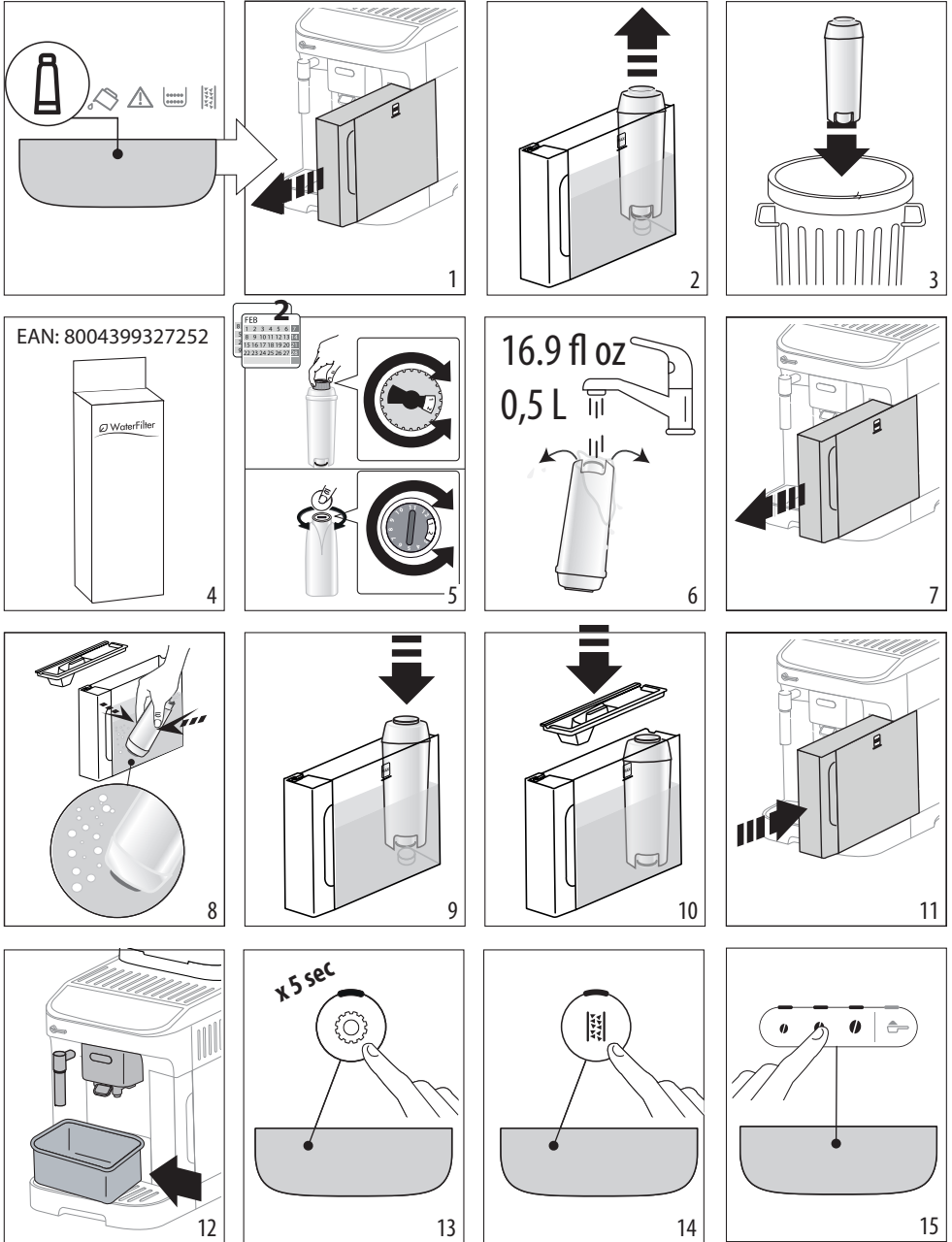



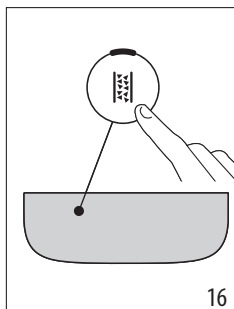

16

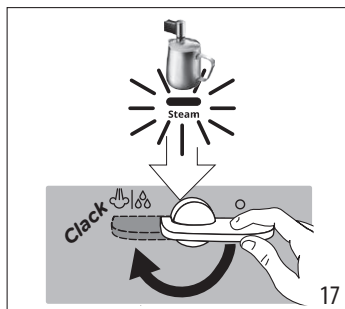

17

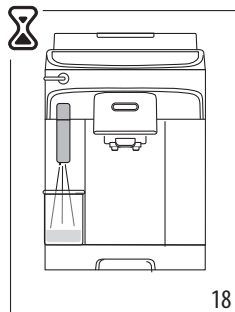

18

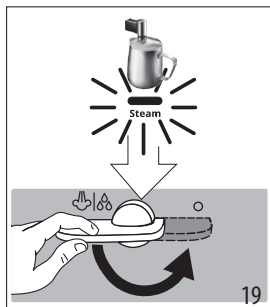

19

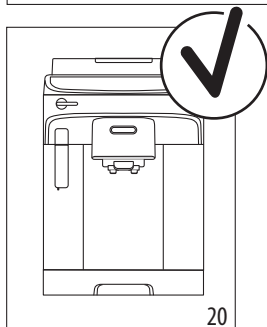

20

### **Nota Bene :**

Quand les deux mois de durée se sont écoulés (voir dateur), ou si l'appareil n'est pas utilisé pendant 3 semaines, procéder au remplacement du filtre même si la machine ne l'exige pas encore.

## **13.2 Retrait du filtre**

Pour continuer à utiliser l'appareil sans le filtre, il faut le retirer et signaler son retrait.

1. Extraire le réservoir d'eau et le filtre usagé ;
2. Voir les instructions du chapitre "15. Settings menu" pour programmer la machine.

## **14. CONSEILS POUR L'ÉCONOMIE D'ÉNERGIE**

- Programmer l'arrêt automatique à 15 minutes (voir "15. Settings menu");
- Activer l'Économie d'Énergie (voir "15. Settings menu");
- Quand la machine l'exige, effectuer le cycle de détartrage.
-





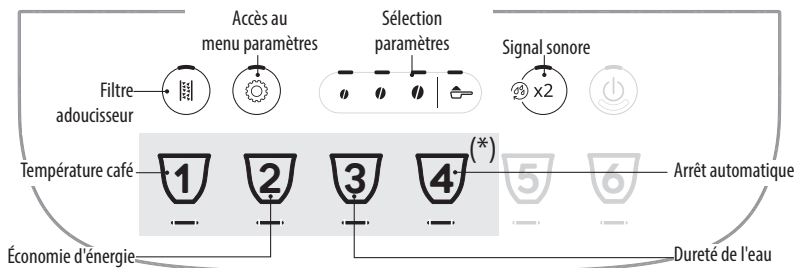





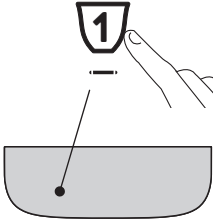



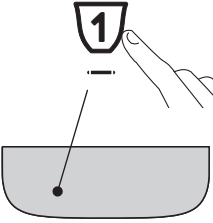
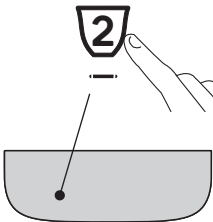

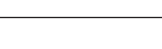
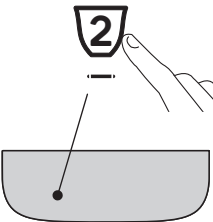
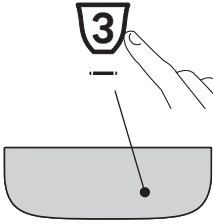
## 15. MENU PARAMÈTRES

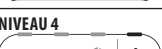
Une fois entrés dans le menu, les touches qui restent actives permettent de sélectionner les fonctions correspondantes :

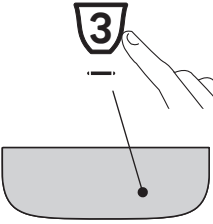
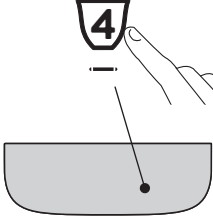

(\*) Les boissons diffèrent suivant le modèle

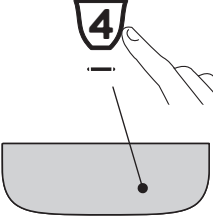
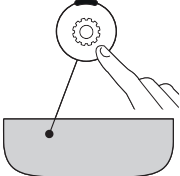

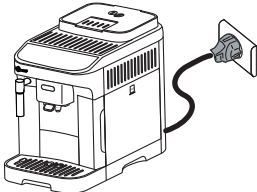
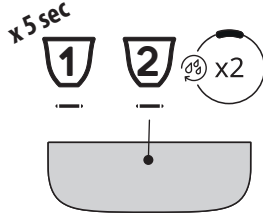
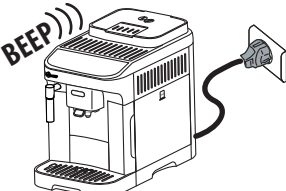

1. Entrer dans le menu :			
<p>x5 sec</p>		<p>Maintenir enfoncée la touche  pendant quelques secondes : les touches relatives aux paramètres s'allument. Appuyer sur la touche relative au paramètre à régler.</p>	
2. Régler les paramètres de la machine :			
<p><b>Filtre adoucisseur</b></p>	<p>Appuyer sur l'un des grains pour installer ou remplacer le filtre adoucisseur</p>	<p>INSÉRÉ</p>	<p><b>Confirmer la sélection</b></p>
	<p>Appuyer sur le symbole du café pré-moulu pour retirer le filtre adoucisseur</p>	<p>RETIRÉ</p>	
<p><b>Signal sonore</b></p>	<p>Appuyer sur l'un des grains pour activer le signal sonore</p>	<p>ON</p>	<p><b>Confirmer la sélection</b></p>
	<p>Appuyer sur le symbole du café pré-moulu pour désactiver le signal sonore</p>	<p>OFF</p>	
→			

<p><b>Température café</b></p> 	<p>Appuyer sur le grain correspondant à la température souhaitée</p>	<p><b>BASSE</b></p>  <p><b>MOYENNE</b></p>  <p><b>ÉLEVÉE</b></p> 	<p><b>Confirmer la sélection</b></p> 
<p><b>Économie d'énergie</b></p> 	<p>Appuyer sur l'un des grains pour activer l'économie d'énergie</p> <p>Appuyer sur le symbole du café pré-moulu pour désactiver l'économie d'énergie</p>	<p><b>ON</b></p>  <p><b>OFF</b></p> 	<p><b>Confirmer la sélection</b></p> 
<p><b>Dureté de l'eau</b></p> 	<p>Appuyer sur le symbole correspondant au niveau à programmer</p>	<p><b>NIVEAU 1</b></p>  <p><b>NIVEAU 2</b></p>  <p><b>NIVEAU 3</b></p>  <p><b>NIVEAU 4</b></p> 	<p><b>Confirmer la sélection</b></p> 
<p><b>Arrêt automatique</b></p> 	<p>Appuyer sur le symbole correspondant au temps à programmer</p>	<p><b>15 MINUTES</b></p>  <p><b>30 MINUTES</b></p>  <p><b>1 HEURE</b></p>  <p><b>3 HEURES</b></p> 	<p><b>Confirmer la sélection</b></p> 
<p><b>3. Quitter le menu :</b></p>			
	<p>Appuyer sur la touche  :</p> <p>La machine est à nouveau prête à l'emploi.</p> <p><b>Nota Bene !</b></p> <p>La machine quitte automatiquement le menu paramètres après 30 secondes d'inutilisation.</p>		

## 15.1 Réinitialisation des valeurs d'usine

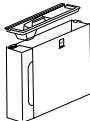
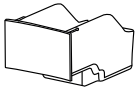
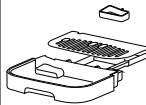



<p>Vérifier que la machine est en veille (éteinte, mais branchée sur secteur).</p>	
<p>Maintenir enfoncées pendant 5 secondes les touches relatives aux boissons 1, 2 et <math>\text{☉} \times 2</math> : tous les paramètres, ainsi que les quantités des boissons, reviennent aux valeurs d'usine.</p>	
<p>La machine émet un bip prolongé et tous les voyants clignotent pour confirmer la réinitialisation</p>	

## 16. NETTOYAGE DE L'APPAREIL

					
 50°C	×	×	×	✓	✓
	✓	✓	✓	✓	✓

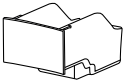
### Attention !

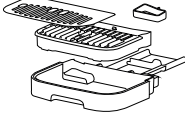
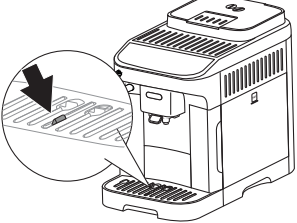
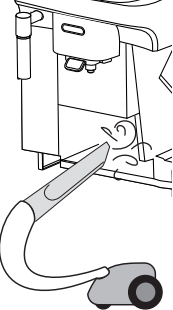
- Pour le nettoyage de la machine, ne pas utiliser de solvants, de nettoyeurs abrasifs ou de l'alcool. Avec les super-automatiques De'Longhi, il n'est pas nécessaire d'utiliser d'adjuvants chimiques pour le nettoyage de la machine.
- Ne pas utiliser d'objets métalliques pour retirer les incrustations ou les dépôts de café car ils pourraient rayer les surfaces en métal ou en plastique.

Composant	Fréquence	Procédure
<p>Tiroir à marc</p> 	<p>Quand le voyant s'allume  il faut vider le tiroir à marc : la machine ne peut pas faire le café.</p> <p>Tant que le tiroir à marc de café n'est pas nettoyé, la machine ne peut pas faire de café. Au cas où 72 heures se seraient écoulées depuis la première préparation effectuée, l'appareil signale la nécessité de vider le tiroir même s'il n'est pas plein, (pour que le décompte des 72 heures soit effectué correctement, la machine ne doit jamais être débranchée du secteur).</p>	<ul style="list-style-type: none"> <li>• Extraire l'égouttoir, le vider et le nettoyer.</li> <li>• Vider et nettoyer soigneusement le tiroir à marc en prenant soin d'enlever tous les résidus qui peuvent se déposer au fond.</li> <li>• Contrôler la coupelle de condensation (rouge) et, si elle est pleine, la vider.</li> </ul>
<p>Composants égouttoir</p> 	<p>L'égouttoir est pourvu d'un flotteur (rouge) qui indique le niveau d'eau présent.</p> <p>Avant que cet indicateur ne commence à dépasser du plateau d'appui pour tasses, il faut vider l'égouttoir et le nettoyer.</p> 	<ul style="list-style-type: none"> <li>• Extraire l'égouttoir et le tiroir à marc de café ;</li> <li>• Retirer le plateau d'appui pour tasses, la grille égouttoir, vider ensuite l'égouttoir et le tiroir à marc de café et laver tous les éléments ;</li> <li>• Contrôler la coupelle de condensation (rouge) et, si elle est pleine, la vider ;</li> <li>• Remettre en place l'égouttoir, la grille et le tiroir à marc de café.</li> </ul> <p>Pour extraire l'égouttoir, il est obligatoire de toujours vider le tiroir à marc de café même s'il est peu rempli.</p>
<p>Intérieur de la machine</p> 	<p>Contrôler régulièrement (environ une fois par mois) que l'intérieur de la machine (accessible une fois l'égouttoir enlevé) n'est pas sale.</p>	<p>Éteindre et débrancher la machine du secteur. Ne jamais plonger la machine dans l'eau.</p> <ul style="list-style-type: none"> <li>• Éliminer les dépôts de café à l'aide d'un pinceau et d'une éponge ;</li> <li>• Aspirer tous les résidus à l'aide d'un aspirateur</li> </ul>
<p>Becs verseurs de café</p> 	<p>Nettoyer périodiquement (une fois par mois) les becs verseurs de café</p>	<ul style="list-style-type: none"> <li>• Nettoyer périodiquement les becs verseurs de café à l'aide d'une éponge ou d'un chiffon ;</li> <li>• Contrôler que les trous des becs verseurs de café ne soient pas bouchés. Si nécessaire, retirer les dépôts de café à l'aide d'un cure-dent.</li> </ul>

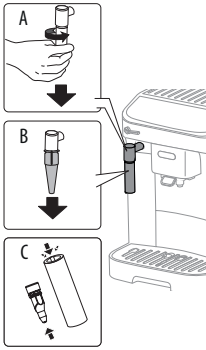

Composant	Fréquence	Procédure
<p>Buse à cappuccino</p> 	<p>Nettoyer la buse à cappuccino à chaque utilisation, pour éviter que des résidus de lait ne se déposent ou que la buse ne se bouche.</p>	<ul style="list-style-type: none"> <li>Positionner un récipient sous la buse à cappuccino et faire couler un peu d'eau pendant quelques secondes en tournant la manette vapeur sur la position I. Puis tourner le bouton vapeur sur 0 pour interrompre l'écoulement d'eau chaude.</li> <li>Attendre quelques minutes que la buse à cappuccino refroidisse ; tenir d'une main la languette du tube de la buse à cappuccino et de l'autre tourner cette dernière dans le sens inverse des aiguilles d'une montre puis tirer vers le bas pour l'extraire.</li> <li>Enlever aussi le gicleur vapeur en le tirant vers le bas.</li> <li>Contrôler que les trous indiqués par la flèche ne sont pas bouchés. Si nécessaire, les nettoyer à l'aide d'un cure-dent.</li> <li>Laver soigneusement les éléments de la buse à cappuccino avec une éponge et de l'eau tiède.</li> <li>Remettre la buse et la buse à cappuccino sur cette dernière en la poussant vers le haut et en la tournant jusqu'à l'accrochage.</li> </ul>

## 17. NETTOYAGE DE L'INFUSEUR

### Attention !

L'infuseur ne peut pas être extrait quand la machine est allumée.

- Appuyer sur la touche  pour éteindre la machine ;
- Extraire le réservoir d'eau ;
- Ouvrir le volet infuseur situé sur le côté droit ;

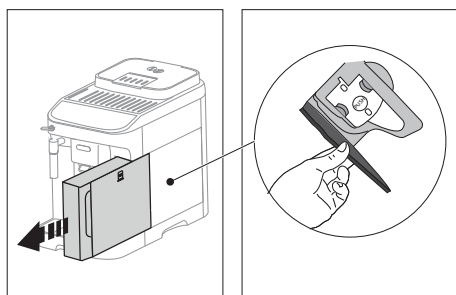

- Enfoncer vers l'intérieur les deux boutons de décrochage colorés et extraire en même temps l'infuseur vers l'extérieur ;

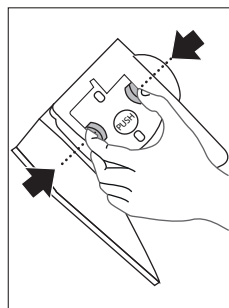

- Plonger l'infuseur dans l'eau pendant environ 5 minutes, puis le rincer sous le robinet ;

### Attention !

RINCER UNIQUEMENT À L'EAU  
PAS DE NETTOYANTS - PAS DE LAVE-VAISSELLE

- Nettoyer l'infuseur sans utiliser de nettoyants, il pourrait s'abîmer.
- En utilisant le pinceau, nettoyez éventuellement les résidus de café présents dans le logement de l'infuseur que vous remarquez en ouvrant le volet infuseur ;
- Après le nettoyage, remettre l'infuseur en place en l'enfiant dans le support ; puis appuyer sur l'inscription PUSH jusqu'au « clic » d'accrochage ;

### Nota Bene :

Si l'infuseur est difficile à insérer, il est nécessaire (avant l'insertion) de l'adapter à la bonne position en appuyant sur les deux leviers.

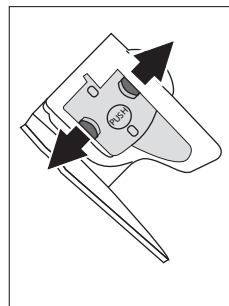
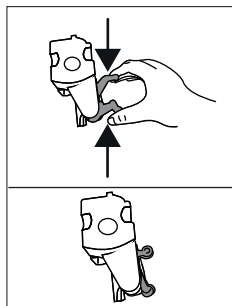

9. Once inserted, make sure the two colored buttons have snapped out;

10. Close the infuser door;  
11. Put the water tank back.

## 18. DÉTARTRAGE

Détartrer la machine quand le voyant  s'allume. Le détartrage rapide de l'appareil lorsque cela est nécessaire garantira les meilleures performances et augmentera la durée de vie de la machine.

Pour effectuer le détartrage	
Détartrant	Détartrant De'Longhi
Récipient	Capacité conseillée : 2 l
Temps	~45min

- Avant l'utilisation, lire les instructions et l'étiquette du détartrant reportées sur l'emballage du détartrant.
- Il est recommandé d'utiliser exclusivement du détartrant De'Longhi. L'utilisation de détartrants non appropriés, ainsi que le détartrage non régulièrement effectué, peut entraîner l'apparition de défauts non couverts par la garantie du producteur.
- Le détartrant peut endommager les surfaces délicates. Si le produit est renversé accidentellement, essuyer immédiatement.

### **Attention :**

Si le filtre adoucisseur est installé, il faut l'enlever avant de verser la solution détartrante.  
Par la suite, réinsérer le filtre à la fin du premier réservoir de rinçage.

### **Please note:**

- Une fois le cycle de détartrage lancé, il n'est pas possible de l'interrompre et il doit être complété par le cycle de rinçage complet.
- Si le cycle de détartrage ne s'est pas terminé correctement (par exemple en cas de panne de courant électrique), à la remise sous tension, la machine reprend le cycle à partir de l'étape interrompue : se référer aux voyants d'intensité ;
- Il est tout à fait normal, après avoir effectué le détartrage, de trouver de l'eau dans le bac récupérateur de marcs de café.
- L'appareil a besoin d'un troisième rinçage, si le réservoir d'eau n'a pas été rempli jusqu'au niveau MAX : ceci pour s'assurer que la solution détartrante a complètement été vidée des circuits internes de l'appareil. Avant de lancer le rinçage, se rappeler de vider l'égoût.

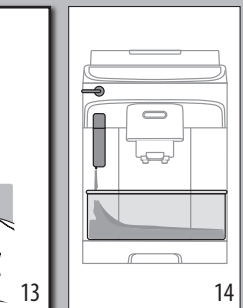
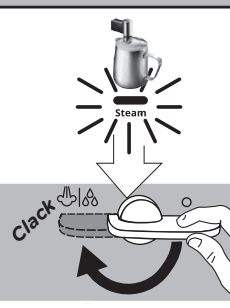
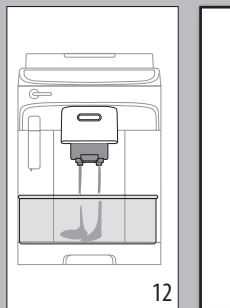
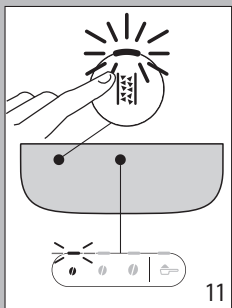
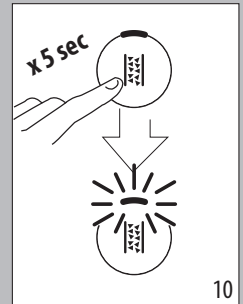
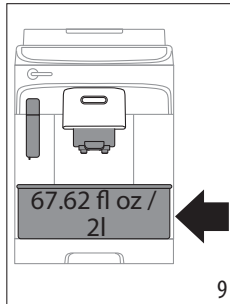
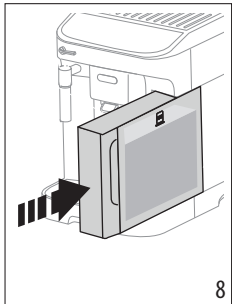
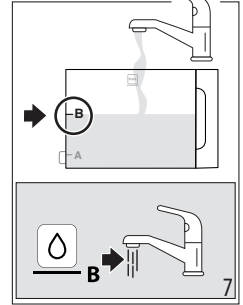
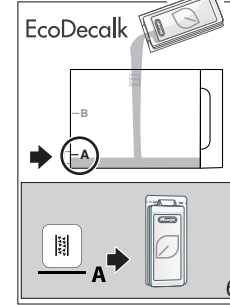
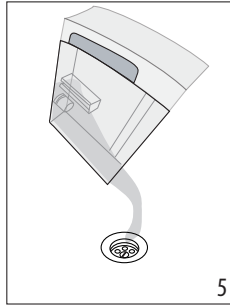
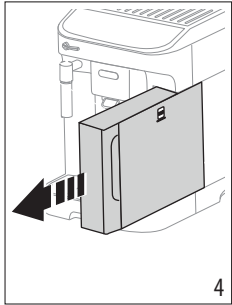
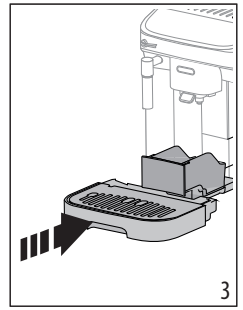
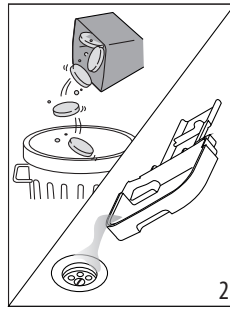
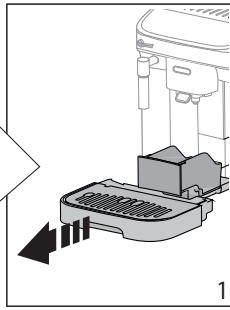
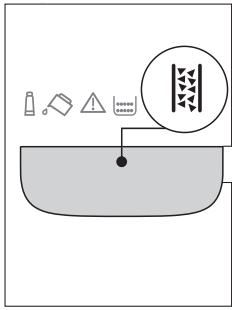



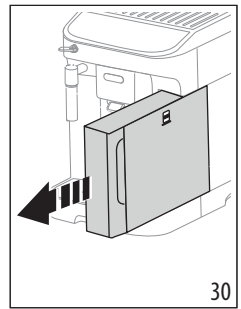
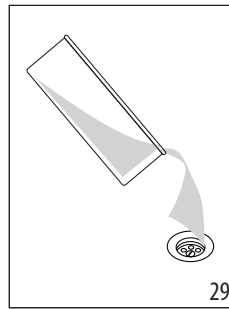
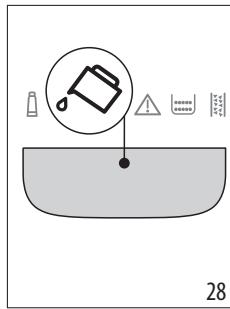
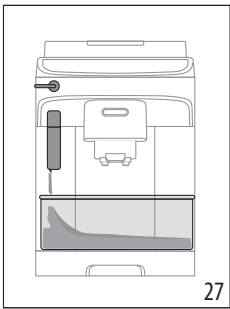
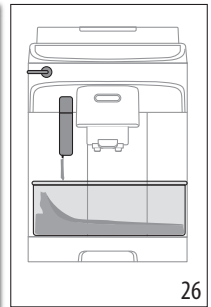
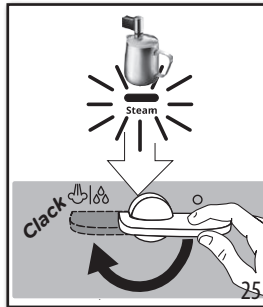
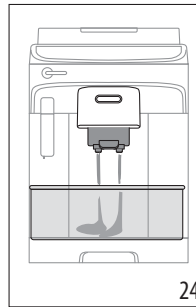
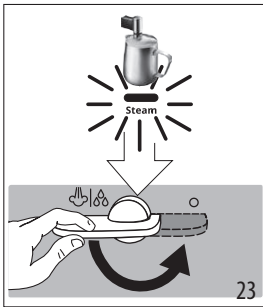
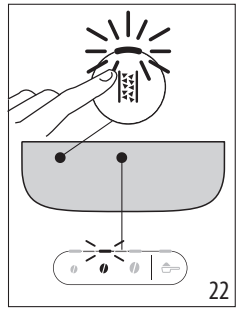
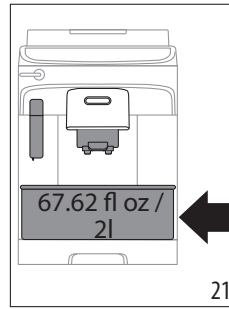
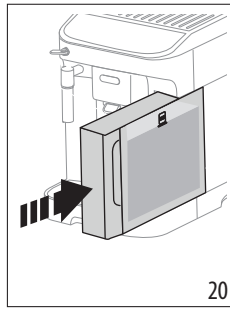
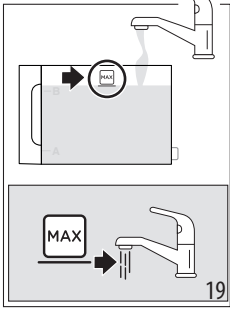
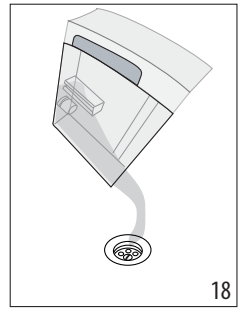
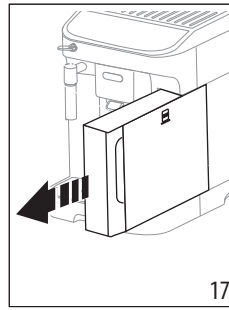
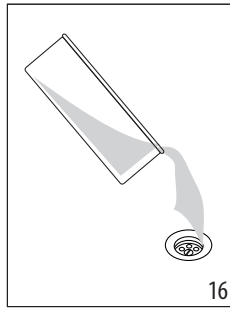
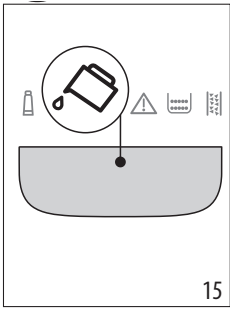

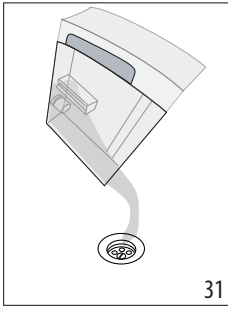

31

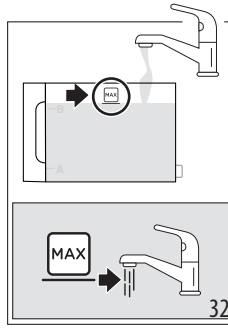

32

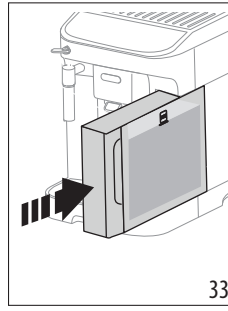

33

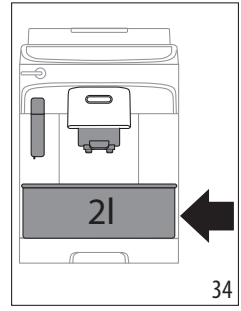

34

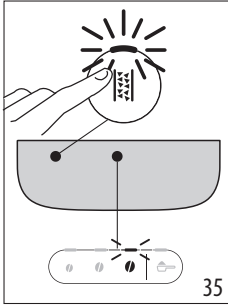

35

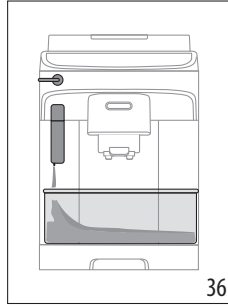

36

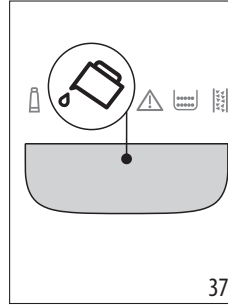

37

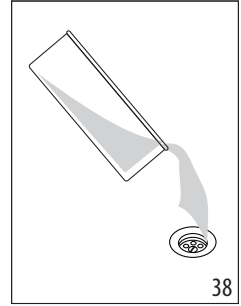

38

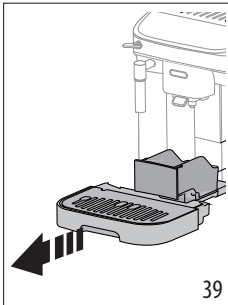

39

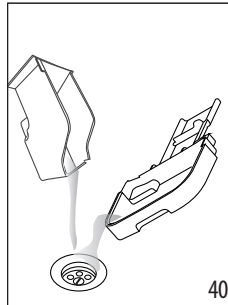

40

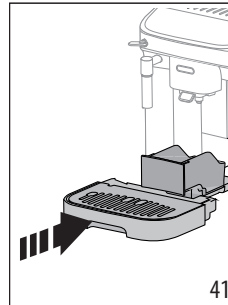

41

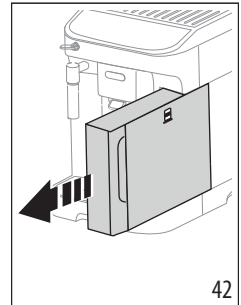

42

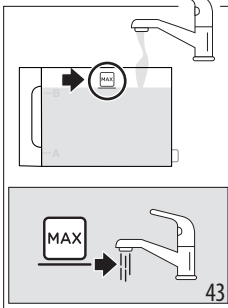

43

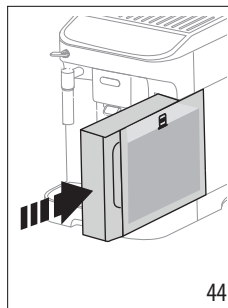

44

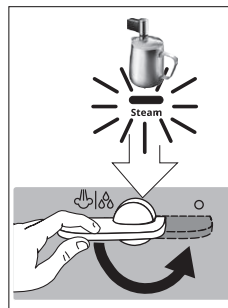

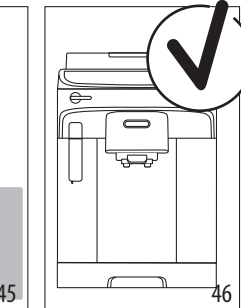

45



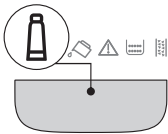
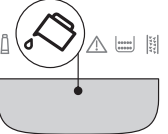
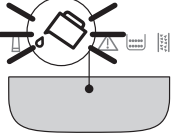
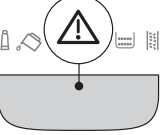
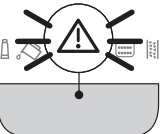

46

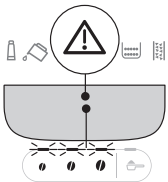
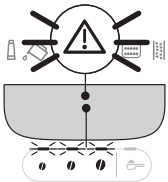
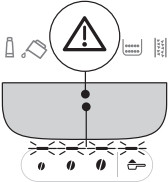
## 19. SIGNIFICATION DES VOYANTS

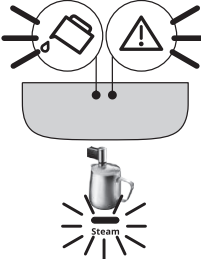
Voyant	Description
Les voyants relatifs aux boissons d'ignotent	La machine est en train de chauffer : attendre
Les voyants relatifs aux boissons et à leurs paramètres sont allumés fixes	La machine est prête à l'emploi : sélectionner la boisson à préparer et les options correspondantes
	Remplacer le filtre (voir chapitre « 7. Filtre adoucisseur »)
	L'eau dans le réservoir n'est pas suffisante : remplir le réservoir
	Le réservoir d'eau n'est pas inséré dans la machine ou n'est pas inséré correctement : insérer correctement le réservoir
	Alarme générique : l'intérieur de la machine est très sale. Nettoyer soigneusement la machine. Si après le nettoyage la machine affiche encore le message, contacter le service clients et/ou un Centre d'Assistance agréé
	L'infuseur n'a pas été inséré après le nettoyage : insérer l'infuseur comme indiqué dans le chapitre « 11. Nettoyage de l'infuseur »
	→

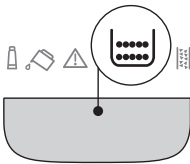
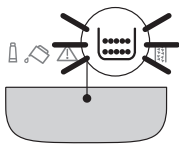
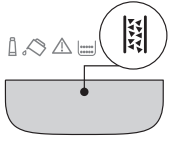
Voyant	Description
	Manque de grains de café : remplir le réservoir à grains, puis appuyer sur une touche quelconque pour acquiescer l'alarme.
	La mouture est trop fine et le café sort par conséquent trop lentement ou ne sort pas du tout. Régler le moulin à café (par. « 4.6 Réglage du moulin à café »)
	Trop de café a été utilisé. Sélectionner un goût plus léger ou réduire la quantité de café pré-moulu
	La fonction «café prémoulu» a été sélectionnée mais aucun café prémoulu n'a été versé dans l'entonnoir. Introduire le café prémoulu dans l'entonnoir et répéter la distribution
	Le circuit hydraulique est vide. Appuyer sur la touche « Steam »
	→

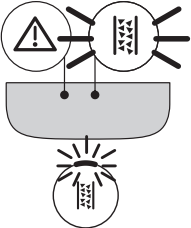
Voyant	Description
	Il faut vider le tiroir à marc
	Le tiroir à marc n'est pas inséré ou n'est pas inséré correctement : insérer l'égouttoir muni de tiroir à marc en pressant à fond
	Il faut procéder au détartrage (« 12. Détartrage ») et la section dédiée du Quick Guide)
→	



Voyant	Description
	Le détartrage a été interrompu. Pour que la machine soit à nouveau prête à l'emploi : 1. Appuyer sur la touche  ; 2. Si le bouton de distribution de la vapeur est sur la pos. 0, le tourner sur la pos.  : la machine commencera à distribuer et le détartrage reprendra à partir de la fig. 14 de la page 10 du Quick Guide.

## 20. TROUBLESHOOTING







Below is a list of some of the possible malfunctions.

If the problem cannot be resolved as described, contact customer services.

PROBLEM	POSSIBLE CAUSE	REMEDY
The appliance does not turn on.	It is not plugged into the mains socket.	Plug into the mains socket.
The coffee is not hot.	The cups were not preheated.	Warm the cups by rinsing them with hot water (Please note: you can use the hot water function).
	The internal circuits of the appliance have cooled down because 2-3 minutes have passed since the last coffee was made.	Before making coffee, press and hold the  button for 5 seconds to perform a rinse cycle and warm the internal circuits.
	Coffee temperature setting too low.	Set a hotter coffee temperature in the settings menu (see "15. Settings menu").
	The machine must be descaled	Carry out the descale procedure. Next, check the water hardness ("12. Measuring water hardness") and make certain the machine setting matches the local water supply hardness ("15. Settings menu").
→		

<b>PROBLEM</b>	<b>POSSIBLE CAUSE</b>	<b>REMEDY</b>
The infuser cannot be extracted.	The machine has not been turned off.	Turn the machine off by pressing the  button.
At the end of descaling, the appliance requests a third rinse	Water tank not filled to the MAX level during the course of the two rinse cycles	Empty the drip tray, fill the tank up to the MAX level and run the third rinse cycle.
The frothed milk has big bubbles	The milk is not cold enough.	Use milk at refrigerator temperature (about 41°F/ 5° C). See section “11. making cappuccino  ” for more details.
	Steam wand dirty.	Remove the components and clean them thoroughly.
	Plant based alternative milk has been used.	The effect varies widely depending on the nutritional properties of the milk.
The cup tray on top of the machine is hot	A number of beverages have been prepared in rapid succession	
The machine emits noises or small puffs of steam while not in use	The machine is ready for use, or has recently been turned off, and condensate is dripping into the hot vaporiser.	This is part of normal operation. To limit this from happening, empty the drip tray.
The appliance emits puffs of steam from the drip tray and/or there is water on the surface the appliance rests on.	The drip tray grille has not been replaced after cleaning.	Put the drip tray grille back in the drip tray.

## SUMARIO

<b>INSTRUCCIONES IMPORTANTES.....</b>	<b>55</b>
CONSERVE ESTAS INSTRUCCIONES .....	55
INSTRUCCIONES CABLE CORTO DE ALIMENTACIÓN .....	55
<b>1. ADVERTENCIAS .....</b>	<b>56</b>
<b>2. INFORMACIÓN GENERAL .....</b>	<b>56</b>
2.1 Instrucciones de uso .....	56
<b>3. OPERACIONES PRELIMINARES .....</b>	<b>56</b>
3.1 Control del aparato.....	56
3.2 Instalación del aparato.....	56
3.3 Conexión del aparato .....	56
3.4 Primera puesta en funcionamiento del aparato.....	57
3.5 Limpieza y mantenimiento de los materiales que están en contacto con alimentos. ..	57
3.6 Preparación de bebidas con leche .....	57
<b>4. INTRODUCCIÓN.....</b>	<b>57</b>
<b>5. DESCRIPCIÓN.....</b>	<b>57</b>
5.1 Descripción del aparato - A.....	57
5.2 Descripción del panel de control - B .....	57
5.3 Descripción de los accesorios - C* .....	58
<b>6. EN EL PRIMER USO .....</b>	<b>58</b>
<b>7. ENCENDIDO Y APAGADO .....</b>	<b>59</b>
<b>8. SUMINISTRO BEBIDA CAFÉ .....</b>	<b>59</b>
8.1 Preparación de 1 taza utilizando el café en granos .....	59
8.3 Preparación del café utilizando el café en granos.....	60
8.4 Variación del aroma del café .....	60
8.5 Enjuague .....	60
8.6 Consejos para el café más caliente.....	60
8.7 Regulación del molinillo.....	60
8.8 Personalizar la cantidad en taza.....	61
8.9 Preparación del café con café pre-molido	61
<b>9. NO SE PUEDE PREPARAR EL CAFÉ  DOPPIO+ CON EL CAFÉ PREMOLIDO.....</b>	<b>61</b>
<b>10. MAKING OVER ICE  .....</b>	<b>62</b>
<b>11. PREPARACIÓN DE L' AGUA CALIENTE  .....</b>	<b>62</b>
<b>12. PREPARACIÓN DEL CAPPUCCINO  .....</b>	<b>62</b>
<b>13. MEDICIÓN DE LA DUREZA DEL AGUA .....</b>	<b>63</b>
<b>15. FILTRO ABLANDADOR.....</b>	<b>64</b>
15.1 Cambio del filtro.....	65
15.2 Extracción del filtro .....	66
<b>16. CONSEJOS PARA EL AHORRO ENERGÉTICO</b>	<b>66</b>
<b>17. SETTINGS MENU .....</b>	<b>66</b>
17.1 Reajuste a los valores de fábrica: .....	69
<b>19. LIMPIEZA GRUPO INFUSOR.....</b>	<b>71</b>
<b>20. DESCALCIFICACIÓN  .....</b>	<b>72</b>
<b>21. SIGNIFICADO DE LOS INDICADORES.....</b>	<b>76</b>
<b>22. SOLUCIÓN DE LOS PROBLEMAS .....</b>	<b>77</b>

# INSTRUCCIONES IMPORTANTES

El uso de casi cualquier aparato eléctrico implica la observación de algunas reglas ¡importantes, entre las que se incluyen las siguientes.

- Lea atentamente las instrucciones.
- Asegúrese de que la tensión (voltaje) de su instalación eléctrica corresponda a la indicada al fondo del aparato.
- No toque las superficies calientes. Use las asas o las perillas.
- Para protegerse de incendios, descargas eléctricas y heridas personales, no sumerja el cable, la clavija o el aparato en agua ni en ningún otro líquido.
- No deje el aparato al manejo de los niños, ni lo deje funcionando sin vigilancia.
- Desconecte la clavija del tomacorriente cuando no lo use y antes de limpiarlo.
- No ponga en funcionamiento al aparato con el cable o la clavija dañados, después de un funcionamiento anómalo del aparato o cuando éste último presente cualquier tipo de daños. Lleve el aparato al centro de servicios autorizado más cercano para que lo examinen, reparen o ajusten.
- El uso de accesorios no indicados por el fabricante puede ser la causa de incendio, descargas eléctricas o heridas personales.
- No use el aparato a la intemperie.
- No deje que el cable de alimentación cuelgue de la mesa o superficie de trabajo para evitar enredarse o tropezarse accidentalmente con éste.
- No coloque el aparato o las partes eléctricas sobre o cerca de hornillas eléctricas, parrillas, estufas y hornos de gas.
- Inserte la clavija al tomacorriente. Para desconectarlo, apague el aparato y saque la clavija.
- No utilice el aparato para usos distintos a los que se indican. El aparato sólo debe ser utilizado para el uso doméstico. El fabricante declina cualquier responsabilidad por los daños derivados del uso inapropiado, incorrecto o irresponsable.

**ADVERTENCIA: Para evitar el peligro de incendio o descargas eléctricas, no quite la cubierta o la parte externa del aparato. No intente reparar o modificar la máquina pues esto anula la garantía. ¡Solamente personal de mantenimiento autorizado ha de efectuar las reparaciones!**

## CONSERVE ESTAS INSTRUCCIONES

ESTE APARATO ESTÁ DESTINADO ÚNICAMENTE PARA EL USO DOMÉSTICO

## INSTRUCCIONES CABLE CORTO DE ALIMENTACIÓN

- El aparato está dotado de un cable corto de alimentación para reducir riesgos derivados de la posibilidad de enredar el cable y evitar tropezar con un cable demasiado largo.
- Es posible utilizar cables removibles o cables de extensión más largos prestando sin embargo mucha atención durante su uso.
- Si se usan cables de extensión, deben ser compatibles para una potencia por lo menos equivalente a la indicada en el aparato. Si el aparato se suministra con un cable con toma de tierra y de 3 hilos, el cable de extensión ha de ser un CABLE DE 3 HILOS CON TOMA DE TIERRA. La parte del cable, que exceda de lo necesario, debe ser dispuesta de modo que no caiga de la mesa o de la superficie de trabajo donde pudiera ser tirado por los niños o bien con el que se pudiera uno tropezar.

- Este producto está equipado con una clavija de corriente alterna polarizada (una clavija con un polo con dimensiones mayores que las del otro). Esta clavija se inserta sólo en un sentido en el tomacorriente. Se trata de un dispositivo de seguridad. Si la clavija no entra completamente en el tomacorriente, deberá girarla. Si tampoco así lo consigue, solicite la intervención de un electricista para sustituir el tomacorriente obsoleto. No intente modificar la clavija polarizada para anular esta medida de seguridad.

## 1. ADVERTENCIAS

Dado que el aparato funciona con corriente eléctrica no se puede excluir que genere descargas eléctricas.

Así pues, atégase a las siguientes advertencias de seguridad:

- No toque el aparato con las manos o los pies mojados.
- No toque la clavija con las manos mojadas.
- Asegúrese de que sea posible acceder en todo momento y libremente a la toma de corriente utilizada, dado que solo así se podrá quitar la clavija cuando sea necesario.
- Si quiere sacar la clavija de la toma manipule directamente la clavija. No tire nunca del cable, porque podría dañarse.
- Para desconectar completamente el aparato quite la clavija de la toma de corriente.
- En caso de averías en el aparato, no intente repararlo. Apáguelo, desenchúfelo y contacte un centro de asistencia.
- Antes de llevar a cabo cualquier operación de limpieza de las partes externas del aparato apague la máquina, quite la clavija de la toma de corriente y deje enfriar la máquina.

### **¡Atención!**

Conserve el material de embalaje (bolsas de plástico, poliestireno expandido) fuera del alcance de los niños.

**RIESGO DE ASFIXIA:** el aparato puede contener partes pequeñas. Es posible que algunas de ellas se desmonten durante las operaciones de limpieza y mantenimiento. Maneje las partes pequeñas con cuidado y manténgalas alejadas de los niños.

### **¡Peligro de quemaduras!**

Este aparato produce agua caliente, de forma que cuando está en funcionamiento puede formarse vapor acuoso.

**Durante el funcionamiento (enjuague automático, salida de bebidas calientes, salida de vapor, operaciones de limpieza), preste atención para no entrar en contacto con salpicaduras de agua o vapor.**

Cuando el aparato está en funcionamiento, la bandeja apoyatazas puede calentarse.

## 2. INFORMACIÓN GENERAL

### 2.1 Instrucciones de uso

Lea detenidamente todas las instrucciones facilitadas antes de usar el aparato. Si no se respetan estas instrucciones se pueden producir lesiones o daños al aparato.

El fabricante queda eximido de toda responsabilidad por los daños derivados del incumplimiento de estas instrucciones de uso.

### **Nota Bene:**

**Estas advertencias de seguridad son válidas para todas las cafeteras De'Longhi.**

**Guarde cuidadosamente este manual con las instrucciones que acompañan al aparato.**

Si traspasa el aparato a otras personas deberá entregarles también estas instrucciones de uso.

## 3. OPERACIONES PRELIMINARES

### 3.1 Control del aparato

Después de haber desembalado la cafetera, asegúrese de que esté íntegra y de que no falten accesorios. No utilice el aparato si presenta desperfectos evidentes. Contacte con el servicio de asistencia técnica De'Longhi.

### 3.2 Instalación del aparato

Al instalar el aparato hay que observar las siguientes advertencias de seguridad:

- El aparato emite calor en el ambiente circundante. Tras haber colocado el aparato en la superficie de trabajo, compruebe que quede un espacio libre de, al menos, 3 cm entre las superficies del aparato, las partes laterales y la parte posterior, y un espacio libre mínimo de 15 cm por encima de la cafetera.
- La eventual entrada de agua en el aparato puede dañarlo. No coloque el aparato cerca de grifos de agua o de pilas.
- El aparato puede estropearse si el agua se congela en su interior. No instale el aparato en un ambiente donde la temperatura puede descender por debajo del punto de congelación.
- Disponga el cable de alimentación de manera que no se estropee con cantos cortantes o por contacto con superficies calientes (por ej. placas eléctricas).

### 3.3 Conexión del aparato

Asegúrese de que la tensión de la red eléctrica corresponda al valor indicado en la placa de datos situada en el fondo del aparato.



Conecte el aparato sólo a un enchufe instalado en conformidad con las normativas, con una capacidad mínima de 10 A y con una toma de tierra eficiente.

En caso de incompatibilidad entre la toma de corriente y la clavija del aparato, haga sustituir la toma por otro adecuado por personal cualificado.

### 3.4 Primera puesta en funcionamiento del aparato

En el primer uso el circuito de agua está vacío y, por ese motivo, la máquina puede hacer mucho ruido: el ruido se irá atenuando a medida que se vaya llenando el circuito.

### 3.5 Limpieza y mantenimiento de los materiales que están en contacto con alimentos.

- Con el primer uso, o bien después de 3 o 4 días de inutilización, limpiar el aparato y los accesorios desmontables, destinados al contacto con agua, café y leche, tal y como previsto en el manual de instrucciones. Verificar en el manual cuáles son los accesorios que se pueden lavar en el lavavajillas.
- Después de 3 o 4 días sin usarlo, se aconseja enjuagar el circuito antes de preparar la primera bebida, como se describe en las instrucciones.
- Se recomienda realizar meticolosamente todas las operaciones de limpieza y mantenimiento descritas en el manual de instrucciones y/o que propone el aparato mediante la pantalla o los indicadores luminosos.

### 3.6 Preparación de bebidas con leche





- La máquina se ha probado para funcionar con leche vacuna y los siguientes productos de origen vegetal: soja, arroz y almendra. No se puede utilizar ningún otro tipo de leche o de productos de origen vegetal.
- En caso de uso de leches diferentes a la vacuna, el sistema se limpia con los mismos procedimientos estándar previstos en el manual de instrucciones.
- Los sistemas de limpieza permitidos por el fabricante que figuran en el manual de instrucciones no garantizan la eliminación completa de los alérgenos.
- En caso de alergias reales o presuntas y de intolerancias, asegúrese de que máquina no ha sido utilizada con tipos de leche o de bebidas de origen vegetal que contienen alérgenos a los que usted es alérgico ni sustancias que no tolera.

## 4. INTRODUCCIÓN

Las principales operaciones de la máquina están ilustradas paso a paso en la Quick Guide.

Dedique un par de minutos a la lectura de estas instrucciones de uso. Así, evitará incurrir en peligros o dañar la máquina.

Los led y los indicadores en el panel de su máquina le ayudarán a interactuar correctamente con ella:

	Apagado	--
	Encendido	Función disponible
	Intermitente	Función en curso
	Intermitente rápido	El aparato requiere la intervención por parte del usuario

## 5. DESCRIPCIÓN

### 5.1 Descripción del aparato - A

- A1. Recipiente granos
- A2. Tapadera del embudo del café premolido
- A3. Tapadera del recipiente para el café en granos
- A4. Regulador del grado de molienda
- A5. Embudo para echar el café premolido
- A6. Mando de vapor/agua caliente
- A7. Boquilla de goma
- A8. Surtidor de vapor/agua caliente
- A9. Dispositivo surtidor café (regulable en altura)
- A10. Bandeja recogedora de líquido de condensación
- A11. Cajón para posos de café
- A12. Bandeja apoyatazas
- A13. Indicador flotante del nivel de agua de la bandeja apoyatazas
- A14. Rejilla de bandeja de goteo
- A15. Bandeja recogegotas
- A16. Tapa del depósito de agua
- A17. Depósito del agua
- A18. Soporte para filtro ablandador de agua
- A19. Cable de alimentación
- A20. Portezuela del grupo de infusión
- A21. Grupo de infusión

### 5.2 Descripción del panel de control - B

- B1. Botón ON/Standby con luz LED integrada
- B2. Botón X2 button con luz LED integrada (Para iniciar el enjuague, es suficiente mantener presionado el botón  x2 por unos 5 segundos)

- B3. Bebidas a selección directa con luz LED integrada (\*Bebidas diversas por tipo y número según el modelo)
- B4. Botón menú configuraciones con luz LED integrada
- B5. Botón de la limpieza del recipiente de la leche con luz LED integrada (mantener presionado el botón para la descalcificación)
- B6. Botón para la variación del aroma y selección de la preparación con café premolido
- B7. Indicador filtro agotado
- B8. Luz fija: falta de agua en el depósito (A17)  
Luz intermitente: falta de depósito

- B9. Indicador alarma general
- B10. Luz fija: bandeja de posos llena  
Luz intermitente: ausencia de bandeja de posos
- B11. Luz descalcificación

### 5.3 Descripción de los accesorios - C\*

- C1. Tira reactiva "Prueba dureza total"
- C1. Medidor dosificador del café premolido
- C2. Descalcificador
- C3. Filtro ablandador

## 6. EN EL PRIMER USO

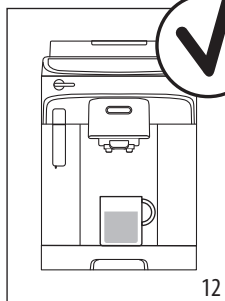
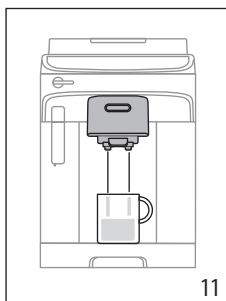
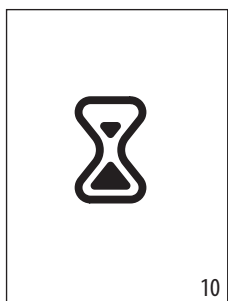
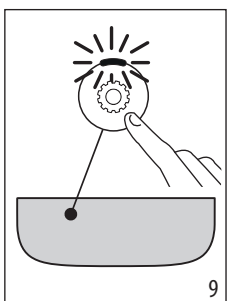
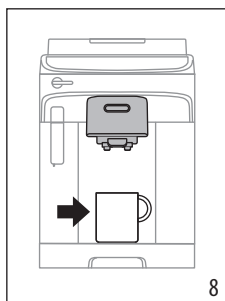
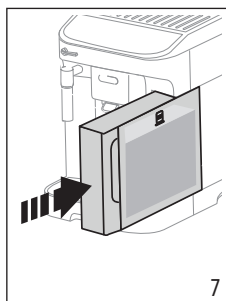
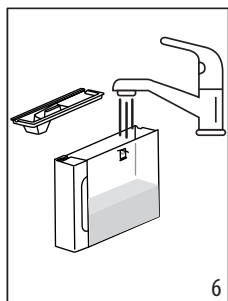
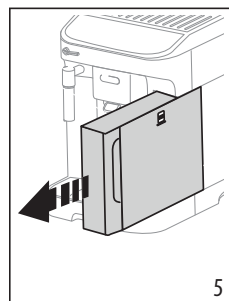
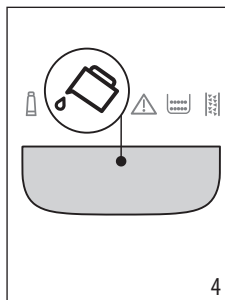
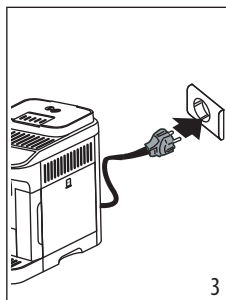
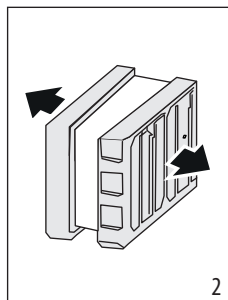
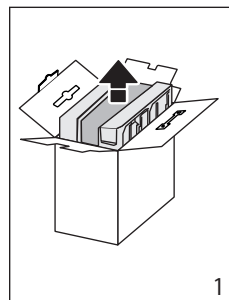

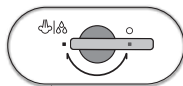

Asegúrese de que el mando vapor se encuentre en la pos. 0.

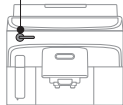

- Cuando utilice por primera vez la cafetera, será necesario preparar 4-5 cappuccini antes de obtener buenos resultados.
- En el primer uso el circuito de agua está vacío, por eso la cafetera puede hacer mucho ruido: el ruido se atenuará a medida que el depósito se vaya llenando.
- Los posibles restos de café en el molinillo se deben a las pruebas de configuración de la máquina previas a su comercialización y son la prueba del cuidado meticuloso que dedicamos al producto.

## 7. ENCENDIDO Y APAGADO

- Cada vez que se enciende el aparato, se realiza automáticamente un ciclo de precalentamiento y de enjuague que no se puede interrumpir. El aparato está listo únicamente después de este ciclo.
- Cada vez que se apaga el aparato efectúa un enjuague automático si se ha preparado un café.

### **¡Peligro quemaduras!**

Durante el enjuague, sale un poco de agua caliente por las boquillas del surtidor de café. Tenga cuidado de no entrar en contacto con salpicaduras de agua.

- Para encender o apagar la cafetera, presione el botón .



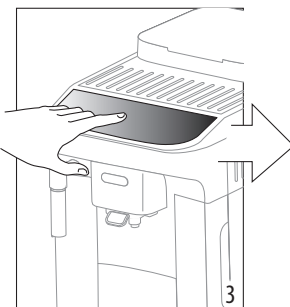
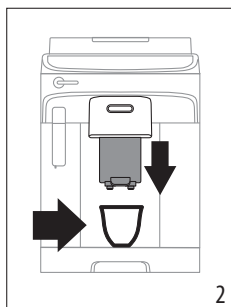
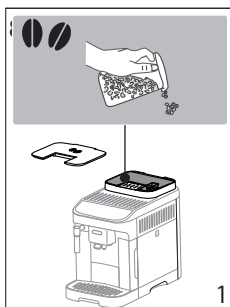

Si el aparato no se utiliza durante periodos prolongados, desconéctelo de la red eléctrica.

## 8. SUMINISTRO BEBIDA CAFÉ

### 8.1 Preparación de 1 taza utilizando el café en granos



(\*)

-  Espresso
-  Coffee
-  Long
-  Doppio+

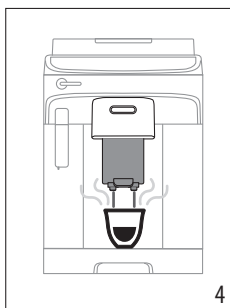

### **Nota bene:**

- No utilice café en granos con caramelo o confitado porque se puede pegar en el molinillo del café y estropearlo.
- Si el modo "Ahorro Energético" está activado, el primer café podría tardar unos segundos en salir.

### 8.3 Preparación del café utilizando el café en granos

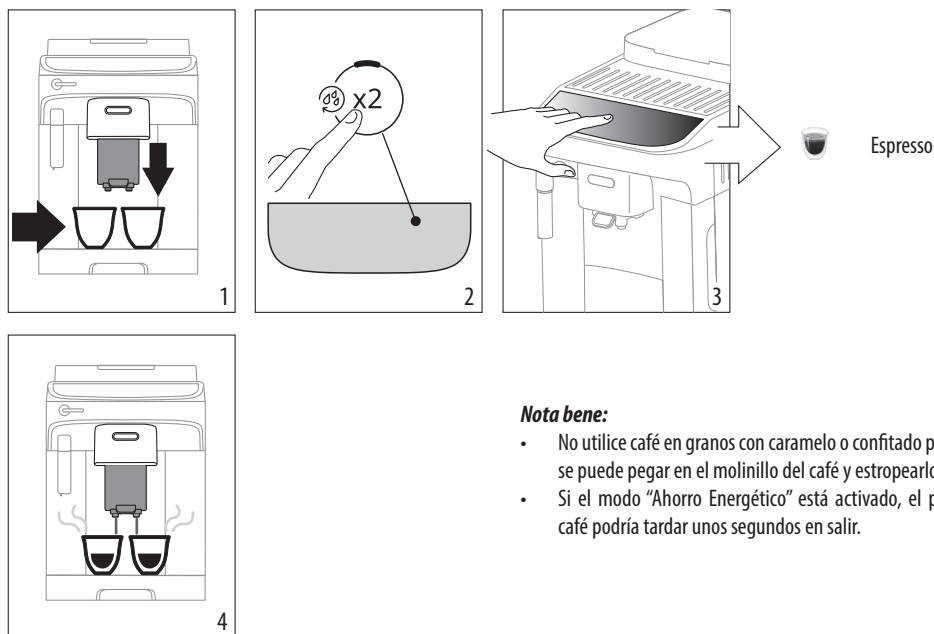



#### **Nota bene:**

- No utilice café en granos con caramelo o confitado porque se puede pegar en el molinillo del café y estropearlo.
- Si el modo "Ahorro Energético" está activado, el primer café podría tardar unos segundos en salir.

### 8.4 Variación del aroma del café

1. Presione el botón relativo al aroma deseado:

	Ligero
	Medio
	Fuerte

2. Proceda seleccionando la bebida de café deseada.

#### **Nota bene:**

- En la siguiente preparación, la máquina propone el último aroma seleccionado.
- En el caso de interrupción de la alimentación eléctrica, la cafetera regresa al nivel medio predeterminado.

### 8.5 Enjuague

Con esta función es posible hacer salir agua caliente por el surtidor de café, para limpiar y calentar el circuito interno de la máquina.

Para iniciar el enjuague, es suficiente mantener presionado el botón  por unos 5 segundos: el suministro se interrumpe automáticamente (si se desea interrumpir antes, presione de nuevo el mismo botón).

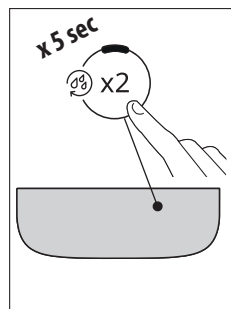

### 8.6 Consejos para el café más caliente



Para obtener un café más caliente, le aconsejamos:

- efectuar un enjuague (véase párrafo "Enjuague";
- caliente las tazas con agua caliente utilice la función agua caliente;
- aumentar la temperatura del café (consulte el capítulo "9. Menú configuraciones").

### 8.7 Regulación del molinillo

No se debe regular el molinillo de café, al menos inicialmente, ya que se ha configurado previamente en fábrica de manera que se obtenga una distribución correcta del café.

Para realizar una corrección, durante el funcionamiento del molinillo, regule el mando como se indica a continuación:





<p>Si el café sale demasiado lento o no sale. El efecto de esta corrección se nota solamente después de haber preparado por lo menos 2 cafés seguidos.</p>	<p>Gire un clic hacia el número 7</p> 
<p>Para un suministro del café con más cuerpo y mejorar el aspecto de la crema El efecto de esta corrección se nota solamente después de haber preparado por lo menos 2 cafés seguidos.</p>	<p>Gire un clic hacia el número 1</p> 

**Nota Bene:**

El botón regulador solo debe girarse mientras el molinillo está en funcionamiento en la fase inicial de preparación de las bebidas a base de café.

**8.8 Personalizar la cantidad en taza**

1. Mantenga presionado por algunos segundos el botón relativo a la bebida a programar: si está en el menú programación cuando el indicador parpadea rápidamente. El suministro comienza;
2. Al alcanzar la cantidad deseada en la taza, presione nuevamente el botón de la bebida: el suministro se interrumpe y la cantidad se memoriza.

Bebida*	Predeterminado (fl oz / ml)	Programmable (fl oz / ml)
 Espresso	1.35 / 40	de ≈ 0.68 / 20 a ≈ 6.08 / 180
 Coffee	6.08 / 180	de ≈ 3.38 / 100 a ≈ 8.11 / 240
 Long	5.41 / 160	de ≈ 3.89 / 115 a ≈ 8.45 / 250
 Doppio+	4.05 / 120	de ≈ 2.70 / 80 a ≈ 6.08 / 180
 Over ice	3.38 / 100	de ≈ 1.35 / 40 a ≈ 8.11 / 240

(\* ) Bebidas diversas por tipo y número según el modelo.

**¡Nota Bene!**

Para anular la programación en curso, presione un botón relativo a otra bebida

**8.9 Preparación del café con café pre-molido**  

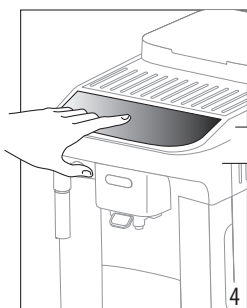
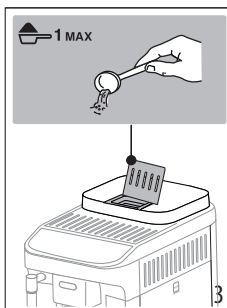
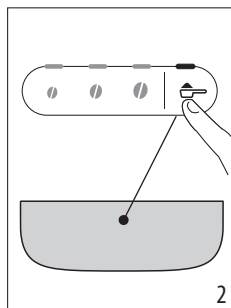
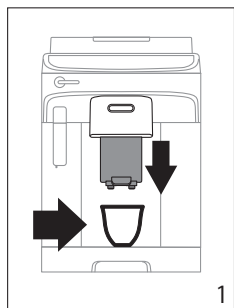



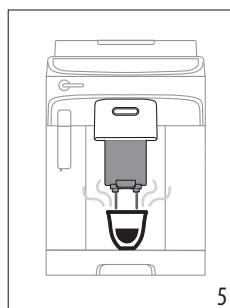

(\* )

-  Espresso
-  Coffee
-  Long



**Nota bene:**

- No eche nunca café premolido con la cafetera apagada para evitar que se disperse en el interior, y la ensucie. En este caso, la cafetera se puede estropear.
- No eche más de 1 medidor raso de café porque se puede ensuciar el interior de la cafetera o se puede obstruir el embudo.
- Preparando el café  Long: en la mitad de la preparación, cuando se encienden los indicadores  +  coloque otro medidor raso de café pre-molido y pulse de nuevo el botón Long.
- 9. No se puede preparar el café  Doppio+ con el café premolido.

## 10. MAKING OVER ICE

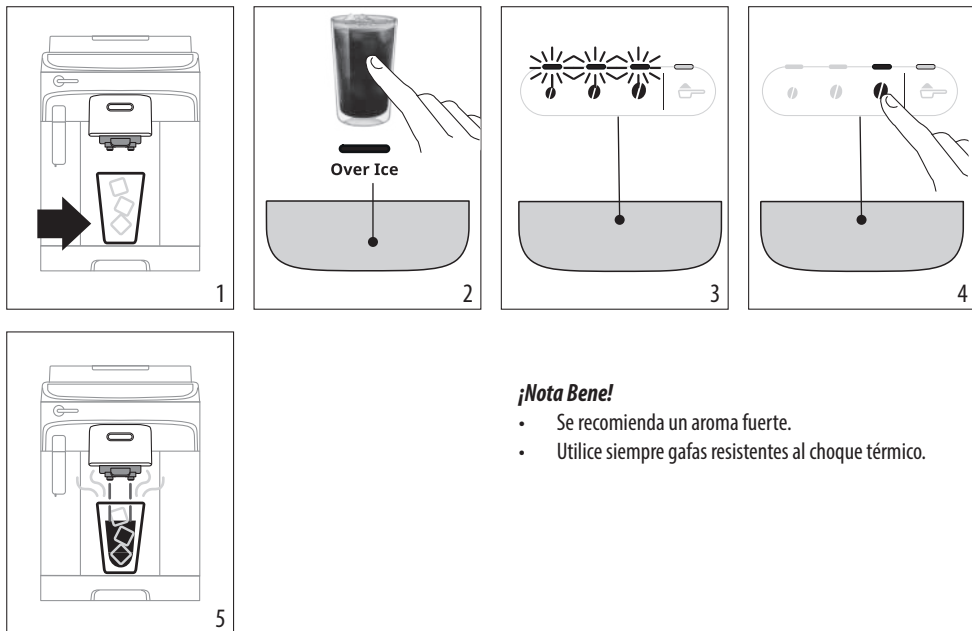

### ¡Nota Bene!

- Se recomienda un aroma fuerte.
- Utilice siempre gafas resistentes al choque térmico.

## 11. PREPARACIÓN DE L' AGUA CALIENTE

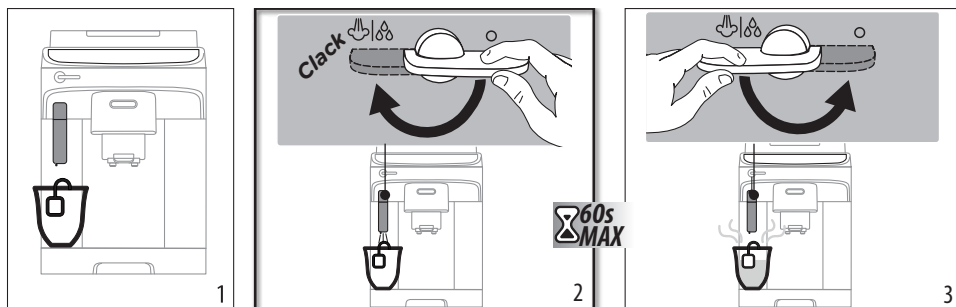

## 12. PREPARACIÓN DEL CAPPUCCINO



- Llene un recipiente con unos 100 gramos de leche por cada capuchino que se desee preparar. En la elección de las dimensiones del recipiente tenga en cuenta que el volumen aumentará en 2 o 3 veces.
- Para obtener una espuma más densa y rica, utilice leche desnatada o semidesnatada y a temperatura de frigorífico (alrededor de 5 °C). Para evitar obtener una leche con poca espuma, o burbujas gruesas, limpie siempre el capuchinador después de cada uso.

- La calidad de la espuma puede variar en base a:
  - tipo de leche o bebida vegetal;
  - marca usada;
  - ingredientes y valores nutricionales.



### 13. MEDICIÓN DE LA DUREZA DEL AGUA

La alarma descalcificación se visualiza durante un periodo de funcionamiento predeterminado que depende de la dureza del agua. La cafetera se ha programado en fábrica para el "Nivel 4" de dureza. Si se desea, se puede programar la cafetera en función de la dureza efectiva del agua usada en las diferentes regiones para reducir la frecuencia de la operación de descalcificación.

1. Quite de su paquete la tira reactiva (si se suministra con su modelo)
2. Sumerja por completo la tira en un vaso de agua durante un segundo más o menos.

14.

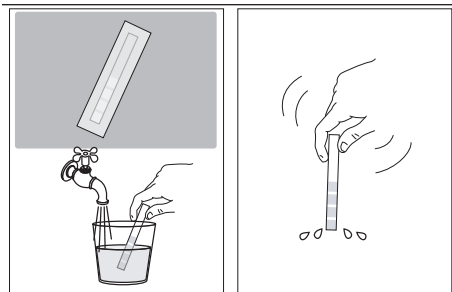

3. Saque la tira del agua y sacúdala ligeramente. Después de alrededor un minuto se forman 1, 2, 3 o 4 cuadraditos de color rojo, en función de la dureza del agua cada cuadradito corresponde a 1 nivel.

Total Hardness Test	Nivel dureza
	<b>1</b> Baja
	<b>2</b> Media
	<b>3</b> Media/Alta
	<b>4</b> Alta

Vea instrucciones en el capítulo "15. Settings menu" para programar la cafetera.

## 15. FILTRO ABLANDADOR

Para mantener constantes en el tiempo los rendimientos de la cafetera, se recomienda utilizar el filtro ablandador De'Longhi. Más información en el sitio [www.delonghi.com](http://www.delonghi.com).

WaterFilter EAN: 8004399327252

Para el uso correcto del filtro, siga las instrucciones que encontrará a continuación.

1. Quite el filtro de la confección y gire el programados hasta visualizar los próximos 2 meses ;

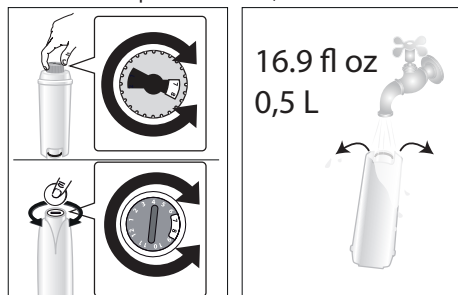

2. Para activar el filtro, deje salir agua corriente del grifo en el agujero central del filtro hasta que el agua salga por las aberturas laterales durante más de un minuto;
3. Saque el depósito del agua de la cafetera y llénelo de agua; introduzca el filtro en el depósito de agua sumergiéndolo completamente por unos diez segundos, inclinándolo y presionándolo ligeramente para permitir que salgan las burbujas de aire;

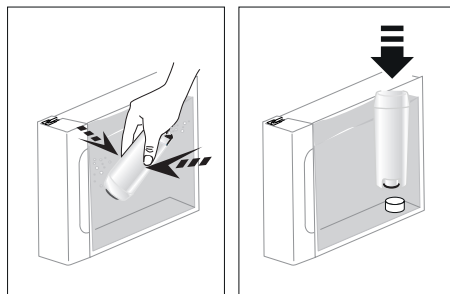

4. Introduzca el filtro en la sede respectiva y presiónelo a fondo;
5. Cierre de nuevo el depósito con la tapa , luego coloque de nuevo el depósito en la cafetera;

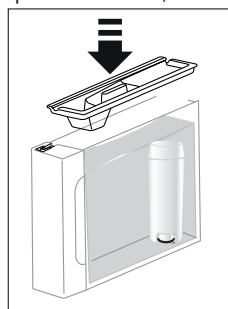

6. Coloque debajo del surtidor vapor/agua caliente un recipiente vacío con capacidad mínima igual a 0,5 litros.
7. Vea instrucciones en el capítulo "9. Menú configuraciones" para instalar el filtro.
8. El aparato suministra agua caliente y se interrumpe automáticamente;
9. El filtro ha quedado activado y la máquina está ahora lista para el uso.



## 15.1 Cambio del filtro

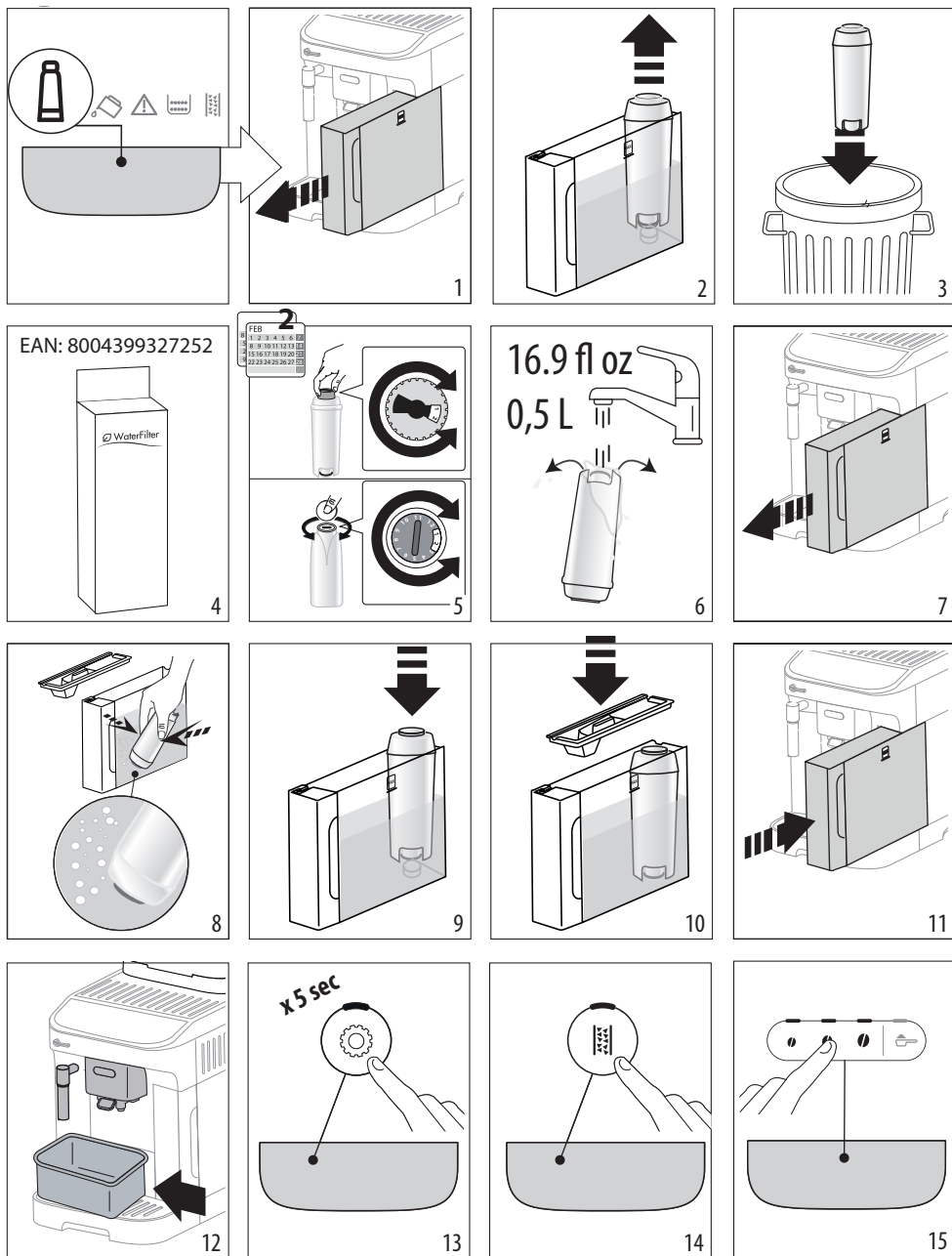

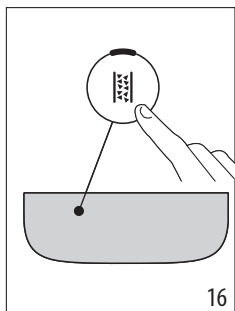

16

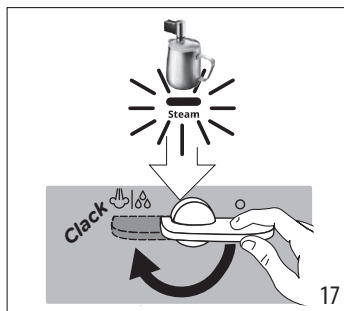

17

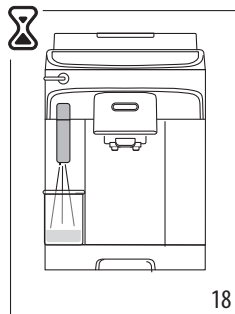

18

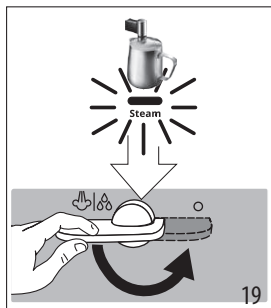

19

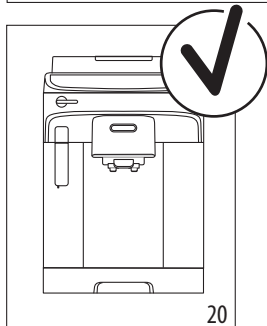

20

**Nota Bene:**

Quando han transcurrido los dos meses de duración (véase programador de fecha), o si no se utiliza el aparato durante 3 semanas, es necesario realizar el cambio del filtro incluso si la máquina aún no lo requiere.

**15.2 Extracción del filtro**

Si se desea seguir utilizando el aparato sin el filtro, es necesario extraerlo e indicar la extracción.

1. Extraiga el depósito de agua y el filtro agotado;
2. Vea instrucciones en el capítulo "15. Settings menu" para programar la cafetera.

**16. CONSEJOS PARA EL AHORRO ENERGÉTICO**

- Configure el autoapagado en 15 minutos (véase "15. Settings menu");
- Active el Ahorro Energético (véase "15. Settings menu");
- Cuando la máquina lo requiera, efectúe el ciclo de descalcificación.

**17. SETTINGS MENU**

When in the menu, use the active buttons to select the corresponding functions:

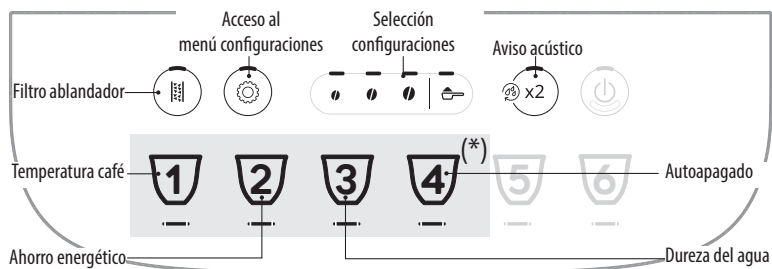

(\*) Bebidas diferentes según el modelo

## 1. Entre en el menú:

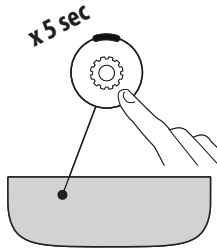

Mantenga presionado el botón  durante algunos segundos: se encienden botones relativos a las configuraciones. Proceda pulsando el botón relativo a la configuración a regular.

## 2. Regule las configuraciones de la máquina:

### Filtro ablandador

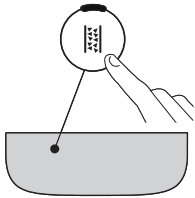

Presione uno de los granos para instalar o sustituir el ablandador

INTRODUCIDO



### Confirme la selección

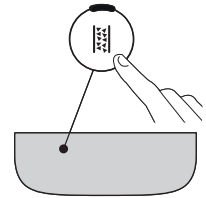

Presione el símbolo premolido para remover el filtro ablandador

REMOVIDO



### Aviso acústico

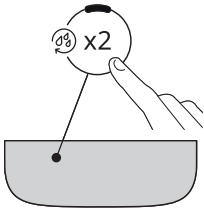

Presione uno de los granos para activar el aviso acústico

ON



### Confirme la selección

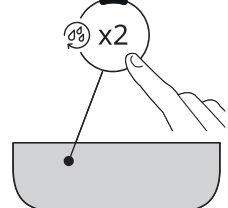

Presione el símbolo premolido para desactivar el aviso acústico

OFF



### Temperatura café

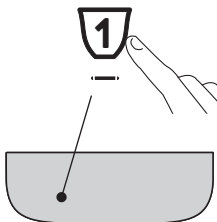

Presione el grano correspondiente a la temperatura deseada

BAJA



### Confirme la selección

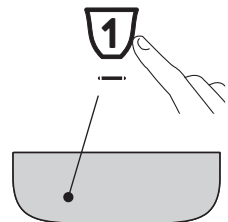















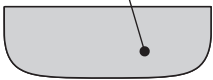





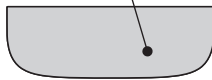

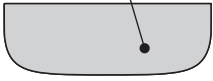
MEDIA



ALTA

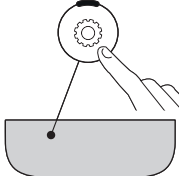



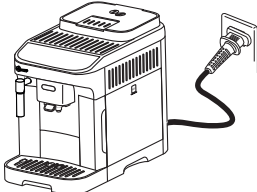
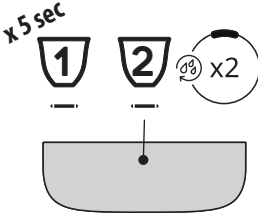
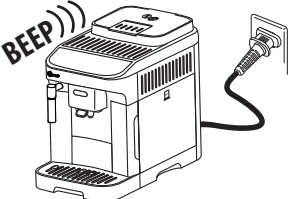

<p><b>Ahorro energético</b></p>  	<p>Presione uno de los granos para activar el ahorro energético</p>	<p>ON</p> 	<p><b>Confirme la selección</b></p>  
<p><b>Dureza del agua</b></p>  	<p>Presione el símbolo correspondiente al nivel a configurar</p>	<p>NIVEL 1</p>  <p>NIVEL 2</p>  <p>NIVEL 3</p>  <p>NIVEL 4</p> 	<p><b>Confirme la selección</b></p>  
<p><b>Autoapagado</b></p>  	<p>Presione el símbolo correspondiente al tiempo a configurar</p>	<p>15 MINUTOS</p>  <p>30 MINUTOS</p>  <p>1 HORA</p>  <p>3 HORAS</p> 	<p><b>Confirme la selección</b></p>  
<p><b>3. Salir del menú:</b></p>			
	<p>Presione el botón : La máquina vuelve a estar lista para su uso.</p> <p><b>¡Nota Bene!</b> La máquina sale automáticamente del menú configuraciones después de 30 segundos de inutilización.</p>		

## 17.1 Reajuste a los valores de fábrica:

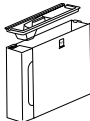
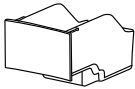
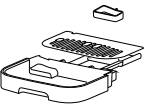



<p>Verifique que la máquina esté en modo de espera (apagada, pero conectada a la red eléctrica).</p>	
<p>Mantenga presionados por 5 segundos los botones relativos a las bebidas 1, 2 y <math>\text{☉}</math> x2 : regresan a los valores de fábrica todas las configuraciones y también las cantidades de las bebidas.</p>	
<p>La máquina emite un bip prolongado y todos los indicadores parpadean para confirmar el reajuste</p>	

## 18. LIMPIEZA DEL APARATO

					
 50°C	<p>×</p>	<p>×</p>	<p>×</p>	<p>✓</p>	<p>✓</p>
	<p>✓</p>	<p>✓</p>	<p>✓</p>	<p>✓</p>	<p>✓</p>

### Important!

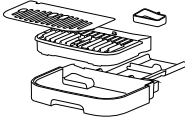
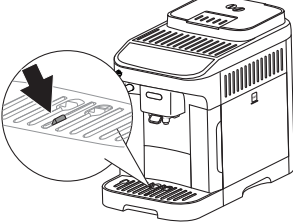
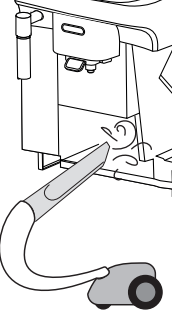
- Para limpiar la cafetera no use disolventes ni detergentes abrasivos, ni alcohol. Con las superautomáticas De'Longhi no hay que utilizar aditivos químicos para limpiar la cafetera.
- No utilice objetos metálicos para eliminar las incrustaciones o los depósitos de café porque podrían rayar las superficies metálicas o plásticas.

Componente	Frecuencia	Procedimiento
<p>Cajón de posos</p> 	<p>Cuando se enciende el indicador  es necesario vaciar el cajón de posos: la máquina no puede preparar el café.</p> <p>Hasta que no se realice la limpieza del cajón de los posos, la cafetera no podrá preparar el café. El aparato señala la necesidad de vaciar el recipiente aunque no esté lleno, si han transcurrido 72 horas desde la primera preparación (para que el recuento de 72 horas se realice correctamente, la cafetera no debe desconectarse nunca de la red eléctrica).</p>	<ul style="list-style-type: none"> <li>• Extraiga la bandeja recogegotas, vacíela y límpiela.</li> <li>• Vacíe y limpie cuidadosamente el cajón de posos eliminando todos los residuos que puedan haberse depositado en el fondo.</li> <li>• Controle la bandeja recogedora de líquido de condensación (de color rojo) y, si está llena, vacíela.</li> </ul>
<p>Componentes bandeja recogegotas</p> 	<p>La bandeja recogegotas tiene un indicador flotante (de color rojo) del nivel de agua contenida. Antes de que dicho indicador empiece a salirse de la bandeja apoyatazas, es necesario vaciar la bandeja y limpiarla</p> 	<ul style="list-style-type: none"> <li>• Saque la bandeja recogegotas y el cajón de los posos de café;</li> <li>• Saque la bandeja apoyatazas, y la rejilla, saque la bandeja recogegotas y el cajón de posos y lave todos los componentes;</li> <li>• Controle la bandeja recogedora de líquido de condensación de color rojo y, si está llena, vacíela.</li> <li>• Vuelva a colocar la bandeja recogegotas con la rejilla y el cajón de los posos de café.</li> </ul> <p>Al extraer la bandeja de goteo es obligatorio vaciar siempre el cajón de los posos de café aunque no esté muy lleno.</p>
<p>Interior de la máquina</p> 	<p>Controle periódicamente (una vez al mes) que en el interior de la máquina (al que puede accederse una vez extraída la bandeja recogegotas) no esté sucio.</p>	<p>Apague y desconecte de la red eléctrica la cafetera. No sumerja nunca la cafetera en el agua.</p> <ul style="list-style-type: none"> <li>• Remueva los depósitos de café con un pincel y una esponja;</li> <li>• aspire todos los residuos con una aspiradora</li> </ul>
<p>Boquillas del surtidor de café</p> 	<p>Limpie periódicamente (una vez al mes) las boquillas del surtidor de café</p>	<ul style="list-style-type: none"> <li>• Limpie periódicamente las boquillas del surtidor de café utilizando una esponja o un paño;</li> <li>• Compruebe que los agujeros del surtidor de café no están obstruidos. Si es necesario, elimine los restos de café con un palillo de dientes.</li> </ul>

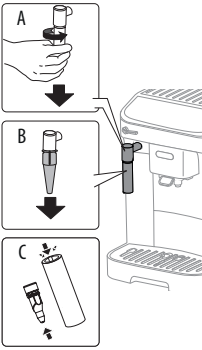

Componente	Frecuencia	Procedimiento
<p>Capuchinador</p> 	<p>Limpe el capuchinador tras cada uso para evitar la acumulación de residuos de leche o la obstrucción del mismo.</p>	<ul style="list-style-type: none"> <li>• Deje salir un poco de agua durante unos segundos girando el mando vapor a la posición I. A continuación vuelva a poner el mando vapor en posición 0 para interrumpir el suministro de agua caliente.</li> <li>A. Espere unos minutos a que el capuchinador se enfríe un poco; luego, con una mano, sujete el asa del tubo del capuchinador y con la otra gire en sentido antihorario.</li> <li>B. Empuje el capuchinador hacia abajo para sacarlo.</li> <li>C. Verifique que los agujeros indicados por la flecha no estén obstruidos. Si es necesario, límpielos con la ayuda de un alfiler.</li> <li>• Lave cuidadosamente los componentes del capuchinador con una esponja y agua tibia.</li> <li>• Vuelva a poner la boquilla y vuelva a meter el capuchinador en la boquilla girándolo y empujándolo hacia arriba hasta que quede enganchado.</li> </ul>

## 19. LIMPIEZA GRUPO INFUSOR

### ¡Atención!

El grupo infusor no se puede extraer cuando la cafetera está encendida.

1. Presione el botón  para apagar la máquina;
2. Saque el depósito del agua;
3. Abra la portezuela del grupo infusor ubicada en el lado derecho;

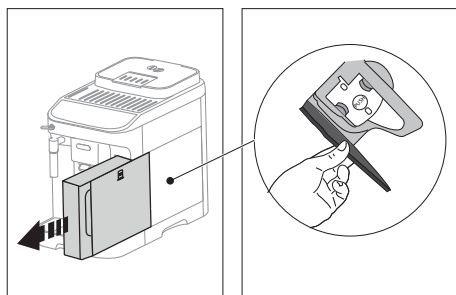

4. Pulse hacia adentro los dos botones de desenganche de colores y extraiga a la vez el grupo infusor hacia afuera;

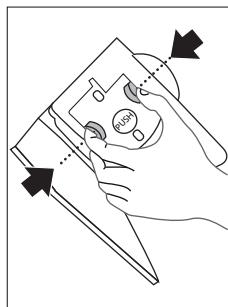

5. Sumerja durante 5 minutos aproximadamente el grupo de infusión en el agua y enjuáguelo bajo el grifo;

### ¡Atención!

ENJUAGUE SOLAMENTE CON AGUA

NO USE DETERGENTES - NO LAVE EN LAVAVAJILLAS

6. Limpe el grupo de infusión sin usar detergentes ya que podría estropearse.
7. Utilizando el pincel, limpie los residuos de café presentes en el soporte del grupo infusor, visibles desde la portezuela de la unidad.
8. Después de la limpieza, vuelva a colocar el grupo infusor en el soporte; a continuación pulse la palabra PUSH hasta oír el clic de enganche;

### Nota Bene:

Si le resulta difícil introducir el grupo infusor, es necesario (antes de colocarlo) llevarlo a la posición justa presionando las dos palancas.

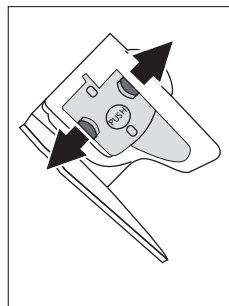
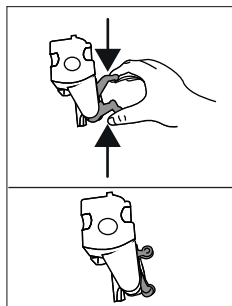

9. Después de haberlo colocado, asegúrese de que los dos botones de colores sobresalgan hacia afuera;

10. Cierre la portezuela del grupo infusor;  
11. Reintroduzca el depósito del agua.

## 20. DESCALCIFICACIÓN

Descalcify the appliance when the corresponding light  turns on. Promptly descaling the unit when required will ensure best performances and increase the lifespan of the machine.

Para efectuar la descalcificación	
Descalcificador	Descalcificador De'Longhi
Recipiente	Capacidad recomendada: 67.62 fl oz / 2 l
Tiempo	~45min

- Antes del uso, lea las instrucciones y las etiquetas del descalcificador, que figuran en su embalaje.
- Se recomienda usar solo descalcificador De'Longhi. El uso de descalcificadores no idóneos, como también la descalcificación no realizada regularmente, puede comportar la aparición de defectos no cubiertos por la garantía.
- El descalcificador puede dañar superficies delicadas. Si el producto se derrama accidentalmente, secar inmediatamente.

### **Atención:**

Si está instalado el filtro ablandador, es necesario quitarlo antes de colocar la solución descalcificante. Luego, reinserte el filtro al final del primer ciclo de enjuague.

### **Nota Bene:**

- Una vez iniciado el ciclo de descalcificación, no es posible interrumpirlo y debe completarse con todo el ciclo de enjuague.
- Es normal que, después de haber realizado el ciclo de descalcificación, haya agua en el cajón de los posos de café.
- El aparato requiere un tercer enjuague, en caso de que el depósito de agua no se haya llenado hasta el nivel MAX: esto para garantizar que no haya solución descalcificadora en los circuitos internos del aparato. Antes de iniciar el enjuague acuérdesese de vaciar la bandeja de goteo.





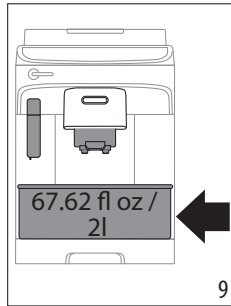
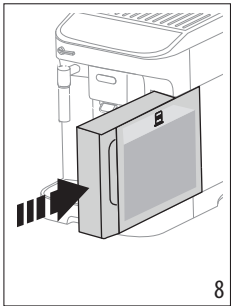
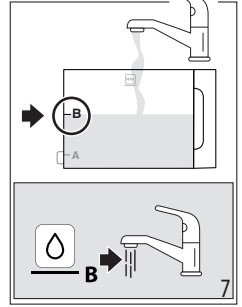
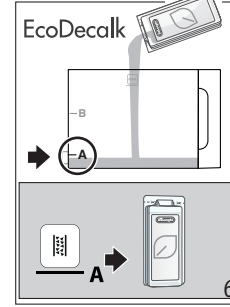
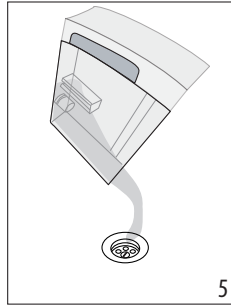
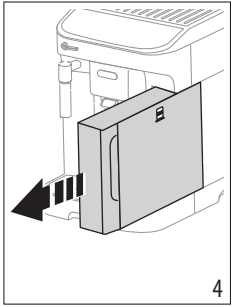
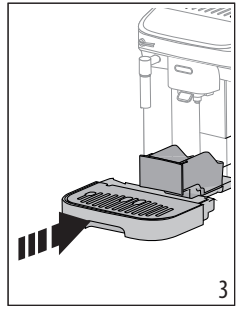
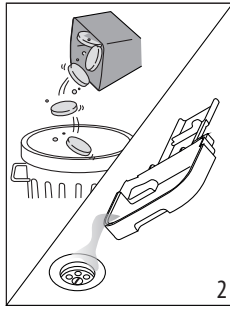
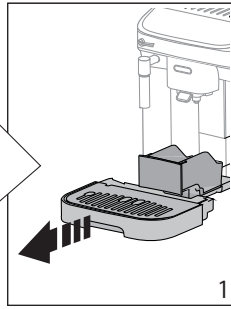
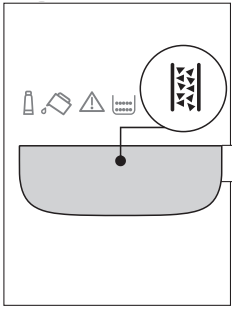

los siguientes pasos  
tomarán alrededor  
45 minutos

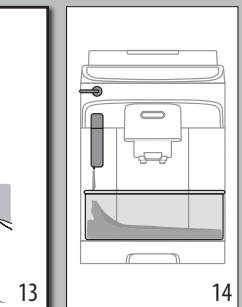
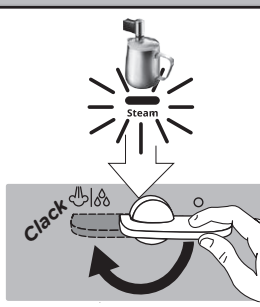
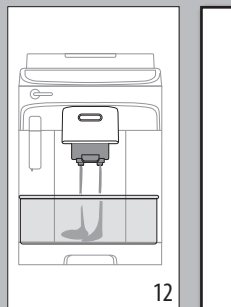
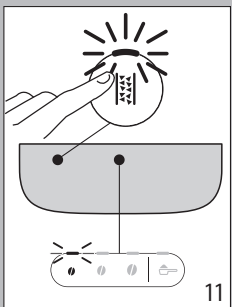
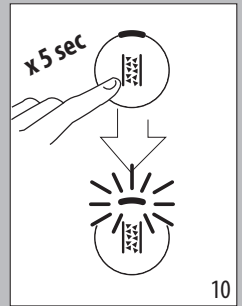

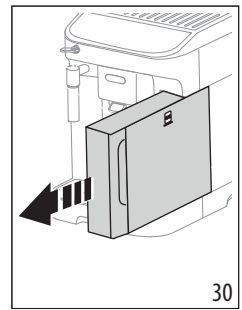
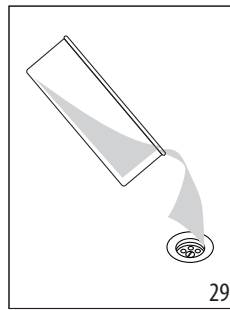
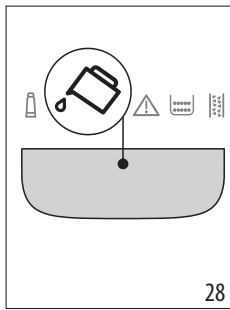
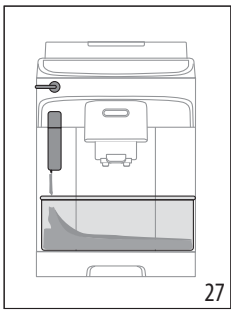
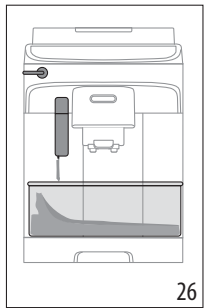
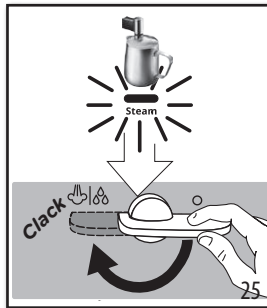
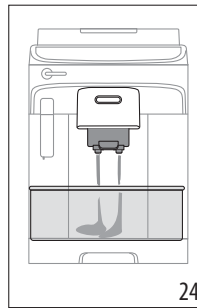
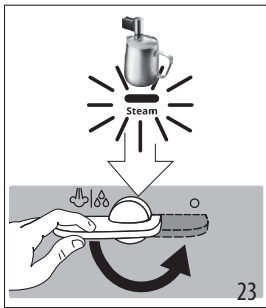
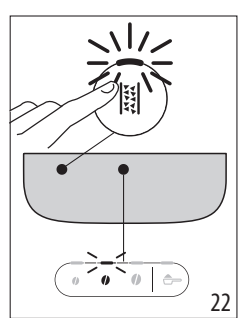
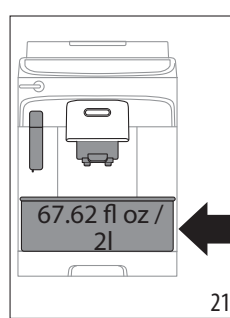
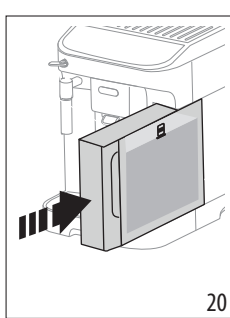
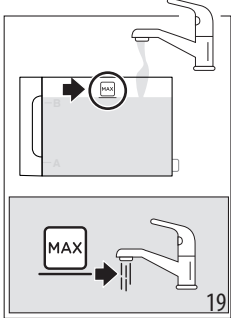
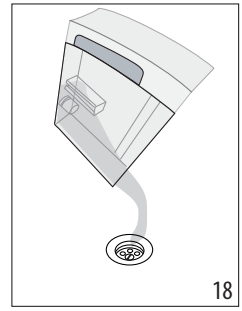
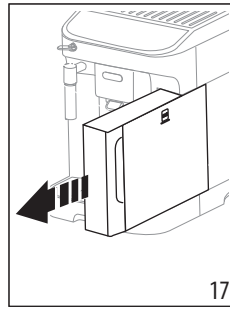
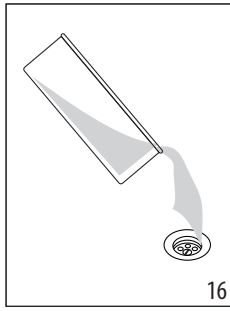
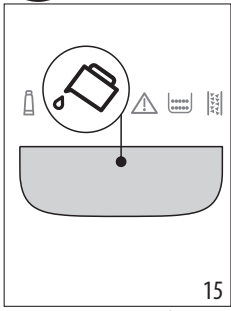

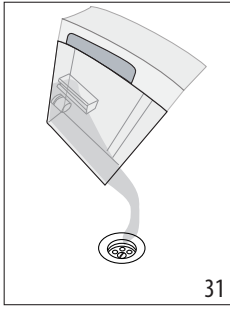

31

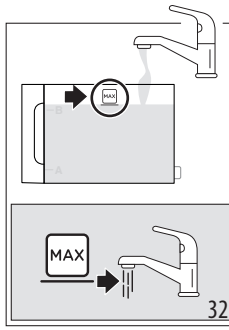

32

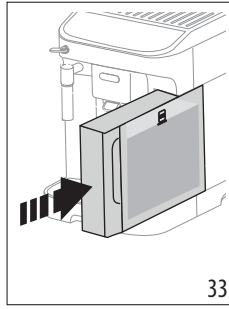

33

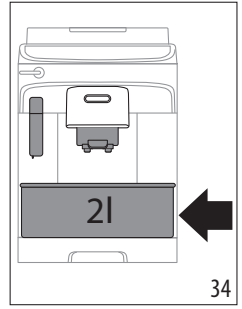

34

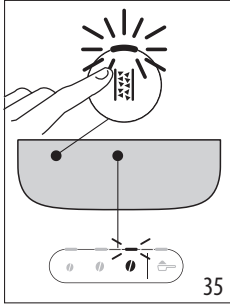

35

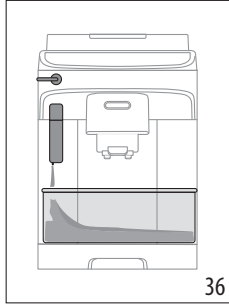

36

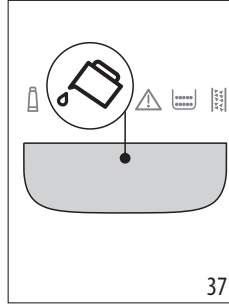

37

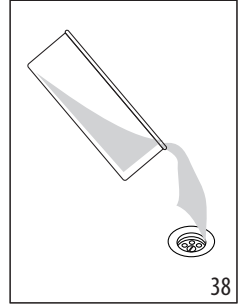

38

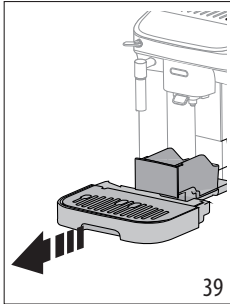

39

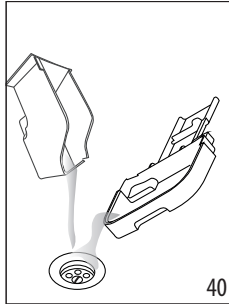

40

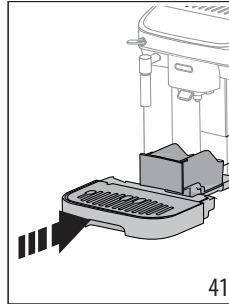

41

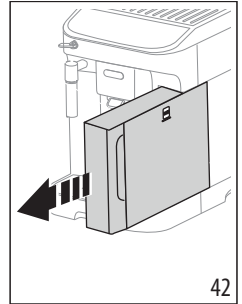

42

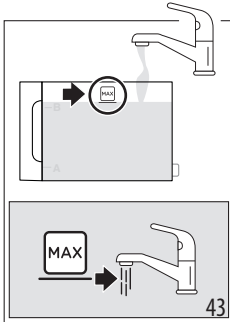

43

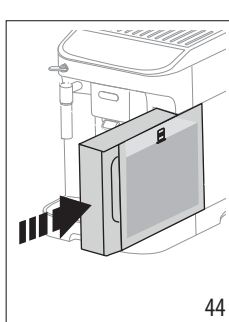

44

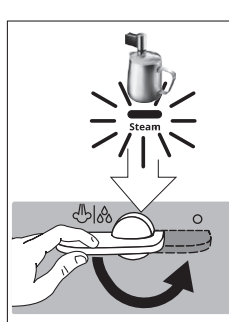



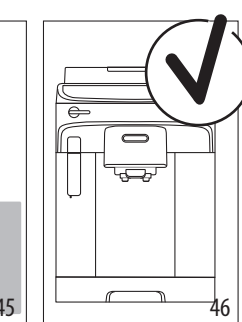

45



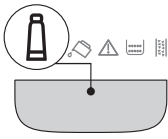
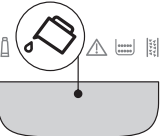
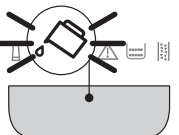

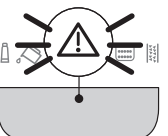
46

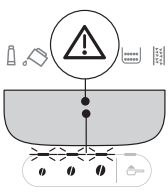
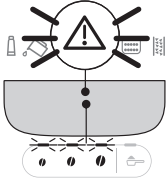
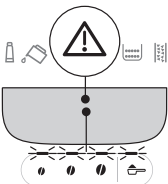
## 21. SIGNIFICADO DE LOS INDICADORES

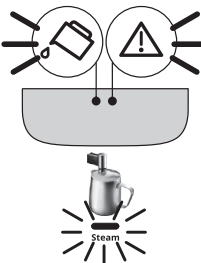
Indicador	Significado
Los indicadores relativos a las bebidas parpadean	La cafetera se está calentando: espere
Los indicadores relativos a las bebidas y a los ajustes relativos están encendidos fijos	La cafetera está lista para el uso: proceda seleccionando la bebida a suministrar y las relativas opciones
	Sustituya el filtro (véase capítulo "7. Filtro ablandador")
	El agua en el depósito no es suficiente: llene el depósito
	El depósito no está colocado en la máquina o no está colocado correctamente: introduzca correctamente el depósito
	Alarma genérica: el interior de la máquina está muy sucio. Limpie meticulosamente la máquina. Si después de realizar la limpieza, la máquina sigue mostrando el mensaje, contacte con el servicio de atención al cliente y/o un Centro de Asistencia autorizado
	Después de la limpieza no se ha colocado el infusor: coloque el infusor como está indicado en el capítulo "11. Limpieza grupo infusor"
	→

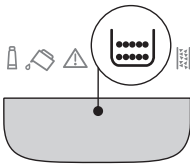
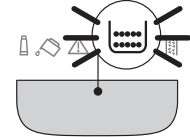
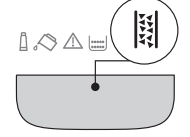
Indicador	Significado
	Faltan granos: llene el recipiente de granos, luego presione cualquier botón para salir de la alarma.
	La molienda es demasiado fina, por lo tanto, el café sale muy lentamente o no sale del todo. Regule la molienda (párr. "4.6 Regulación del molinillo")
	Se ha echado demasiado café. Seleccionar un gusto más suave o reducir cantidad pre-molido
	Se ha seleccionado la función "café premolido", pero no se ha echado el café premolido en el embudo. Eche el café premolido en el embudo y repita el suministro
	El circuito hidráulico está vacío. Presione el botón "Steam"
	→

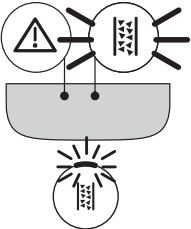
Indicador	Significado
	Es necesario vaciar el cajón de los posos
	El cajón de los posos no está colocado o no está colocado correctamente: coloque la bandeja recogegotas con el cajón de los posos presionando a fondo
	Es necesario proceder con la descalcificación ("12. Descalcificación" y la sección dedicada de la Quick Guide.)
→	

Indicador	Significado
	La descalcificación ha sido interrumpida. Para volver a estar lista para el uso: <ol style="list-style-type: none"> <li>1. Presione el botón ;</li> <li>2. Si el mando de suministro de vapor está en pos. 0, gírelo a pos. : la cafetera comenzará a suministrar y la descalcificación se reanudará desde fig. 14 de pág. 10 de la Quick Guide.</li> </ol>

## 22. SOLUCIÓN DE LOS PROBLEMAS

A continuación, se enumeran algunos posibles funcionamientos incorrectos.

Si no puede resolverse el problema en el modo descrito, póngase en contacto con la asistencia técnica.

PROBLEMA	POSIBLE CAUSA	SOLUCIÓN
El aparato no se enciende.	La clavija no está conectada a la toma.	Conecte la clavija a la toma.
El café no está caliente.	Las tazas no se han precalentado.	Caliente las tazas enjuagándolas con agua caliente (N.B: se puede utilizar la función agua caliente).
	Los circuitos internos del aparato se han enfriado porque han transcurrido 2/-3 minutos desde el último café.	Antes de preparar el café caliente los circuitos con un enjuague, manteniendo presionado el botón  durante algunos segundos.
	La temperatura programada del café es baja.	Configure una temperatura café más alta en el menú configuraciones (véase "9. Menú configuraciones").
	Indica que es necesario descalcificar la cafetera	Realice la descalcificación. Sucesivamente verificar el nivel de dureza del agua ("6. Medición de la dureza del agua") y comprobar si el aparato está configurado según la dureza efectiva ("9. Menú configuraciones").
→		

<b>PROBLEMA</b>	<b>POSIBLE CAUSA</b>	<b>SOLUCIÓN</b>
El café tiene poco cuerpo o poca crema.	El café se ha molido demasiado grueso.	Regule la molienda ("4.6 Regulación del molinillo"). El efecto es visible solo después de haber preparado por lo menos 2 cafés.
	El café no es adecuado.	Use café para cafeteras de café expreso.
	El café no es fresco.	El paquete de café está lleva abierto mucho tiempo y ha perdido el sabor.
El café sale muy lentamente o goteando.	El café se ha molido demasiado fino.	Regule la molienda ("4.6 Regulación del molinillo"). El efecto es visible solo después de haber preparado por lo menos 2 cafés.
La máquina no suministra el café	La máquina detecta impurezas en su interior	Espere a que la máquina regrese a estar lista para el uso y seleccione la bebida deseada. Si el problema persiste, contacte con el centro de asistencia autorizado.
El café no sale por una o por ninguna de las boquillas del dispositivo de suministro.	Las boquillas del surtidor de café están obstruidas.	Limpie las boquillas con un paño. Si es necesario, utilice un palillo de dientes para remover posibles incrustaciones.
El café preparado está aguado.	El embudo para el café premolido está obstruido.	Abra la puerta, limpie el embudo con la ayuda de un pincel.
El grupo infusor no se puede extraer.	No se ha realizado el apagado.	Realice el apagado presionando el botón  .
Al finalizar la descalcificación el aparato requiere un tercer enjuague	Durante los dos ciclos de enjuague, el depósito de agua no se ha llenado hasta el nivel MÁX	Vacíe bandeja recogegotas, llene el depósito hasta el nivel MÁX y realice el tercer enjuague.
La leche tiene burbujas grandes	La leche no está suficientemente fría o no es parcialmente descremada o descremada.	Utilice leche desnatada o totalmente semidesnatada, a la temperatura de la nevera (unos 5°C). Si no se obtiene un buen resultado, intente cambiar la marca de la leche.
	El capuchinador está sucio.	Desmunte los componentes y límpielos minuciosamente.
	Se utilizan bebidas vegetales.	El resultado varía mucho en base a las características nutricionales de las bebidas.
El nivel apoyatazas sobre la máquina está caliente	Se han preparado varias bebidas en rápida sucesión	
La máquina no está en funcionamiento y hace ruido o emite pequeños resoplidos de vapor	La máquina está preparada para el uso o se ha apagado hace poco y algunas gotas de condensación caen dentro del vaporizador aún caliente.	Este fenómeno forma parte del normal funcionamiento del aparato: para limitarlo vacíe la bandeja recogegotas.
→		

<b>PROBLEMA</b>	<b>POSIBLE CAUSA</b>	<b>SOLUCIÓN</b>
El aparato emite resoplidos de vapor por la bandeja recoge gotas y/o hay agua sobre la superficie en que está colocado el aparato.	Después de la limpieza, no se ha vuelto a poner la rejilla bandeja.	Vuelva a colocar la rejilla bandeja en la bandeja de goteo.

**Register Now**   
[www.delonghi.photo](http://www.delonghi.photo)

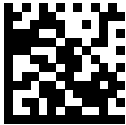

57132C7697\_00\_0322 - Printed in Italy