Tecnogas SUPERIORE

**USE AND CARE MANUAL
FOR 48" GAS RANGES**

461308471

Tecnogas SUPERIORE

MANUFACTURED BY:

**TECNO SPA
STRADA PROVINCIALE 63R 42044
GUALTIERI RE ITALY**

For product information, call 1-844-322-2111, or visit the
TECNOGAS SUPERIORE Web site at Tecnogassuperiore.us

Congratulations

Congratulations and welcome to the world of TECNOGAS SUPERIORE. We hope you will enjoy and appreciate the care and attention we have put into every detail of your new, state-of-the-art range.

Your TECNOGAS SUPERIORE PRODUCT is designed to offer years of reliable service. This Use and Care Manual will provide you with the information you need to become familiar with your range's care and operation.

Your complete satisfaction is our ultimate goal. If you have any questions or comments about this product, please contact the dealer from whom you purchased it, contact our CUSTOMER CARE SERVICE or visit our YOUTUBE CHANNEL AT [YOUTUBE.COM/TECNOGAS-SUPERIORE](https://www.youtube.com/TECNOGAS-SUPERIORE).

We appreciate your choice of a TECNOGAS SUPERIORE range and hope that you will again select our products.

For more information about the complete and growing selection of TECNOGAS SUPERIORE products, contact your dealer or visit us online at [TECNOGASSUPERIORE.US](https://www.tecnogassuperiore.us)

GRAZIE!

Antonio Di Tommaso
CEO



Table of Contents

Getting Started Warnings	6
Before Using Range.....	15
Range Features.....	16
Surface Operation.....	20
Burners.....	22
Electric griddle.....	23
Induction.....	25
Using your Induction Worktop.....	27
Choosing the right Cookware.....	31
Using Induction Worktop special features.....	33
Oven functions and settings.....	38
Oven features.....	39
Using the Oven.....	40
Baking.....	41
Convection Bake.....	45
Defrost.....	47
Broiling.....	48
Cleaning and Maintenance.....	52
Replacing Oven Lights.....	56
Door Glass Removal.....	57
Door Replacement and Adjustment.....	58
Troubleshooting.....	59
Service Information.....	60

Warnings

Getting Started Warning and Important Safety Instructions appearing in this manual are not meant to cover all possible conditions and situations that may occur. Common sense, caution, and care must be exercised when installing, maintaining or operating the appliance.

ALWAYS contact the manufacturer about problems or conditions you do not understand.

Recognize Safety Symbols, Words, Labels



DANGER

Hazards or unsafe practices which **WILL** result in severe personal injury or death



DANGER

Hazards or unsafe practices which **COULD** result in death or severe personal injury



DANGER

Hazards or unsafe practices which **COULD** result in minor personal injury.

All safety messages will identify the hazard, tell you how to reduce the chance of injury, and tell you what can happen if the instructions are not followed.

Read and follow all instructions before using this appliance to prevent the potential risk of fire, electric shock, personal injury or damage to the appliance as a result of improper usage of the appliance. Use appliance only for its intended purpose as described in this manual.

To ensure proper and safe operation: Appliance must be properly installed and grounded by a qualified technician. **DO NOT** attempt to adjust, repair, service, or replace any part of your appliance unless it is specifically recommended in this manual. All other servicing should be referred to a qualified servicer. Have the installer show you the location of the gas shutoff valve and how to shut it off in an emergency. A certified technician is required for any adjustments or conversions to Natural or LP gas.

KEEP THESE INSTRUCTIONS FOR FUTURE REFERENCE

Warnings



DANGER

If the information in this manual is not followed exactly, a fire or explosion may result causing property damage, personal injury or death.

WHAT TO DO IF YOU SMELL GAS:

- **DO NOT** try to light any appliance.
- **DO NOT** touch any electrical switch.
- **DO NOT** use any phone in your building.
- Immediately call your gas supplier from a neighbor's phone. Follow the gas supplier's instructions.
- If you cannot reach your gas supplier, call the fire department.

Installation and service must be performed by a qualified installer, service agency or the gas supplier.



DANGER



TIPPING HAZARD

To reduce the risk of the appliance tipping, it must be secured by a properly installed anti-tip bracket(s). To make sure the bracket has been installed properly, look behind the range with a flashlight to verify proper installation engaged in the rear top left corner of the range.



- **THIS RANGE CAN TIP**
- **INJURIES TO PERSONS CAN RESULT**
- **INSTALL ANTI-TIP DEVICE PACKED WITH RANGE**
- **SEE INSTALLATION INSTRUCTIONS**



DANGER

DO NOT use commercial oven cleaners inside the oven. Use of these cleaners can produce hazardous fumes or can damage the porcelain finishes.



DANGER



To avoid risk of property damage, personal injury or death; follow information in this manual exactly to prevent a fire or explosion. **DO NOT** store or use gasoline or other flammable vapors and liquids in the vicinity of this or any appliance.

Warnings

To Prevent Fire or Smoke Damage

- Be sure all packing materials are removed from the appliance before operating it.
- Keep area around appliance clear and free from combustible materials, gasoline, and other flammable vapors and materials.
- If the appliance is installed near a window, proper precautions should be taken to prevent curtains from blowing over burners.
NEVER leave any items on the top. The hot air from the vent may ignite flammable items and may increase pressure in closed containers which may cause them to burst.
- Many aerosol-type spray cans are **EXPLOSIVE** when exposed to heat and may be highly flammable. Avoid their use or storage near an appliance.
- Many plastics are vulnerable to heat. Keep plastics away from parts of the appliance that may become warm or hot. **DO NOT** leave plastic items on the range top as they may melt or soften if left too close to the vent or alighted surface burner.
- Combustible items (paper, plastic, etc.) may ignite and metallic items may become hot and cause burns. **DO NOT** pour spirits over hot foods.
DO NOT leave oven unsupervised when drying herbs, breads, mushrooms, etc; fire hazard.

In Case of Fire

Turn off appliance and ventilating hood to avoid spreading the flame. Extinguish flame then turn on hood to remove smoke and odor.

- **Worktop:** Smother fire or flame in a pan with a lid or cookie sheet.
- **NEVER** pick up or move a flaming pan.
- **Oven:** Smother fire or flame by closing the oven door. **DO NOT** use water on grease fires. Use baking soda, a dry chemical or foam-type extinguisher to smother fire or flame.
- Grease is flammable and should be handled carefully. **DO NOT** use water on grease fires. Flaming grease can be extinguished with baking soda or, if available, a multi-purpose dry chemical or foam type extinguisher. Let fat cool before attempting to handle it. **DO NOT** allow grease to collect around the oven or in vents. Wipe up spillovers immediately.

Child Safety

- **NEVER** leave children alone or unsupervised near the appliance when it is in use or is still hot.
- **NEVER** allow children to sit or stand on any part of the appliance as they could be injured or burned.
- **DO NOT** store items of interest to children over the unit. Children climbing to reach items could be seriously injured.

Warnings

- Children must be taught that the appliance and utensils in it can be hot. Let hot utensils cool in a safe place, out of reach of small children. Children should be taught that an appliance is not a toy. Children should not be allowed to play with controls or other parts of the appliance.

Cooking Safety

- To eliminate the hazard of reaching over hot surface burners, cabinet storage should not be provided directly above a unit. If storage is provided, it should be limited to items which are used frequently and which are safely stored in an area subjected to heat from an appliance. Temperatures may be unsafe for some items, such as volatile liquids, cleaners or aerosol sprays.
- **ALWAYS** place a pan on a surface burner before turning it on. Be sure you know which knob controls which surface burner. Make sure the correct burner is turned on and that the burner has ignited. When cooking is completed, turn burner off before removing pan to prevent exposure to burner flame.
- **ALWAYS** adjust surface burner flame so that it does not extend beyond the bottom edge of the pan. An excessive flame is hazardous, wastes energy and may damage the appliance, pan or cabinets above the appliance. This is based on safety considerations.
- **NEVER** leave a surface cooking operation unattended especially when using high heat setting or when deep fat frying. Boilovers cause smoking and greasy spillovers may ignite. Clean up greasy spills as soon as possible.
DO NOT use high heat for extended cooking operations.
- **DO NOT** heat unopened food containers, build up of pressure may cause the container to explode and result in injury.
- Use dry, sturdy pot-holders. Damp pot-holders may cause burns from steam. Dishtowels or other substitutes should **NEVER** be used as potholders because they can trail across hot surface burners and ignite or get caught on appliance parts.
- **ALWAYS** let quantities of hot fat used for deep fat frying cool before attempting to move or handle.
- **DO NOT** let cooking grease or other flammable materials accumulate in or near the appliance, hood or vent fan. Clean hood frequently to prevent grease from accumulating on hood or filter.
When flaming foods under the hood, turn the fan off.
- **NEVER** wear garments made of flammable material or loose fitting or long-sleeved apparel while cooking. Clothing may ignite or catch utensil handles. **DO NOT** drape towels or materials on oven door handles. These items could ignite and cause burns.

Warnings

- **ALWAYS** Place oven racks in the desired positions while oven is cool. Slide oven rack out to add or remove food, using dry, sturdy pot-holders. **ALWAYS** avoid reaching into the oven to add or remove food. If a rack must be moved while hot, use a dry pot-holder.
- **ALWAYS** turn the oven off at the end of cooking.
- Use care when opening the oven door. Let hot air or steam escape before moving or replacing food.
- **NEVER** use aluminum foil to cover oven racks or oven bottom. This could result in risk of electric shock, fire, or damage to the appliance. Use foil only as directed in this guide.
- **PREPARED FOOD WARNING:** Follow food manufacturer's instructions. If a plastic frozen food container and/or its cover distorts, warps, or is otherwise damaged during cooking, immediately discard the food and its container. The food could be contaminated.
- If you are “flaming” liquor or other spirits under an exhaust, **TURN THE FAN OFF.** The draft could cause the flames to spread out of control.
- Once the unit has been installed as outlined in the Installation Instructions, it is important that the fresh air supply is not obstructed. The use of a gas cooking appliance results in the production of heat and moisture in the room in which it is installed. Ensure that the kitchen is well-ventilated. Keep natural venting holes open or install a mechanical ventilation device. Prolonged or intensive use of the appliance may call for additional (such as opening a window) or more effective ventilation (such as increasing the level of a mechanical ventilation if present).

Utensil Safety

- Use pans with flat bottoms and handles that are easily grasped and stay cool. Avoid using unstable, warped, easily tipped or loose-handled pans. Also avoid using pans, especially small pans, with heavy handles as they could be unstable and easily tip. Pans that are heavy to move when filled with food may also be hazardous.
- Be sure utensil is large enough to properly contain food and avoid boilovers. Pan size is particularly important in deep fat frying. Be sure pan will accommodate the volume of food that is to be added as well as the bubble action of fat.
- To minimize burns, ignition of flammable materials and spillage due to unintentional contact with the utensil, **DO NOT** extend handles over adjacent surface burners. **ALWAYS** turn pan handles toward the side or back of the appliance, not out into the room where they are easily hit or reached by small children.
- **NEVER** let a pan boil dry as this could damage the utensil and the appliance.
- Follow the manufacturer's directions when using oven cooking bags.

Warnings

- Only certain types of glass, glass/ceramic, ceramic or glazed utensils are suitable for rangetop surface or oven usage without breaking due to the sudden change in temperature. Follow manufacturer's instructions when using glass.
- This appliance has been tested for safe performance using conventional cookware. **DO NOT** use any devices or accessories that are not specifically recommended in this guide. **DO NOT** use eyelid covers for the surface units, stovetop grills, or add-on oven convection systems. The use of devices or accessories that are not expressly recommended in this manual can create serious safety hazards, result in performance problems, and reduce the life of the components of the appliance.
- The flame of the burner should be adjusted to just cover the bottom of the pan or pot. Excessive burner setting may cause scorching of adjacent counter-top surfaces, as well as the outside of the utensil. This is based on safety considerations.

Heating Elements

- **NEVER** touch oven bake and broil burner areas or interior surfaces of oven.
- Bake and broil burners may be hot even though they are dark in color. Areas near burners and interior surfaces of an oven may become hot enough to cause burns.
- During and after use, **DO NOT** touch or let clothing or other flammable materials contact heating elements, areas near elements, or interior surfaces of oven until they have had sufficient time to cool. Other surfaces of the oven may become hot enough to cause burns, such as the oven vent opening, the surface near the vent opening, and the oven door window.

Cleaning Safety

- Turn off all controls and wait for appliance parts to cool before touching or cleaning them. **DO NOT** touch the burner grates or surrounding areas until they have had sufficient time to cool.
- Clean appliance with caution. Use care to avoid steam burns if a wet sponge or cloth is used to wipe spills on a hot surface. Some cleaners can produce noxious fumes if applied to a hot surface.
- No commercial oven cleaner or oven liner protective coating such as aluminum foil should be used in or around any part of the oven. Improper oven liners may result in a risk of electric shock or fire. Keep oven free from grease buildup.

Warnings



WARNING

NEVER use appliance as a space heater to heat or warm a room to prevent potential hazard to the user and damage to the appliance. Also, **DO NOT** use the range top or oven as a storage area for food or cooking utensils.

About Your Appliance

- For proper oven performance and operation, **DO NOT** block or obstruct the oven vent duct located in the backguard/island trim.
- Avoid touching oven vent area while oven is on and for several minutes after oven is turned off. When the oven is in use, the vent and surrounding area become hot enough to cause burns. After oven is turned off, **DO NOT** touch the oven vent or surrounding areas until they have had sufficient time to cool.
- Other potentially hot surfaces include rangetop, areas facing the rangetop, oven vent, surfaces near the vent opening, oven door, areas around the oven door and oven window.
- The misuse of oven doors (e.g. stepping, sitting, or leaning on them) can result in potential hazards and/or injuries.

Power Failure

If power failure occurs, the electric igniters will not work. No attempt should be made to operate the appliance during a power failure. Make sure the oven control is in the "OFF" position.

Momentary power failure can occur unnoticed. The range is affected only when the power is interrupted. When it comes back on, the range will function properly without any adjustments. A "brown-out" may or may not affect range operation, depending on how severe the power loss is.



WARNING

ELECTRICAL SHOCK HAZARD



DO NOT touch a hot oven light bulb with a damp cloth as the bulb could break. Should the bulb break, disconnect power to the appliance before removing bulb to avoid electrical shock.

Warnings



WARNING

NEVER cover any slots, holes or passages in the oven bottom or cover an entire rack with materials such as aluminum foil. Doing so blocks air flow through the oven and may cause carbon monoxide poisoning. Aluminum foil linings may also trap heat, causing a fire hazard.



WARNING

ELECTRICAL SHOCK HAZARD



Disconnect the electric power at the main fuse or circuit breaker before replacing bulb.



WARNING

BURN OR ELECTRICAL SHOCK HAZARD



Make sure all controls are OFF and oven is COOL before cleaning. Failure to do so can result in burns or electrical shock.



CAUTION

To avoid sickness and food waste, **DO NOT** allow defrosted food to remain in the oven for more than two hours.



NOTICE

DO NOT turn the Temperature Control on during defrosting. Turning the convection fan on will accelerate the natural defrosting of the food without the heat.

Warnings



CAUTION



BURN HAZARD

The oven door, especially the glass, can get hot.

Danger of burning: DO NOT touch the glass!



CAUTION

You must carefully check the food during the dehydration process to ensure that it does not catch fire.



CAUTION

DO NOT store items of interest to children over the unit. Children climbing to reach items could be seriously injured.

Before Using Range

All products are wiped clean with solvents at the factory to remove any visible signs of dirt, oil, and grease which may have remained from the manufacturing process. Before starting to cook, clean the range thoroughly with hot, soapy water. There may be some burn off and odors on first use of the appliance this is normal.

Oven

Important! Before first use, wipe interior with soapy water and dry thoroughly. Then set the oven selector to bake, the thermostat to 450°F or 500 °F, and operate for an hour.

All models include:

- Five performance modes including convection baking providing air circulation for shorter cooking times with even results;
- Six rack positions and three wire shelves providing ample space for your baking needs. One wire shelf is provided for the auxiliary oven;
- One telescopic glide shelf;
- Two lights illuminating the main oven cavity and two illuminating the auxiliary cavity;
- Main cavity equipped with 2 convection fans and broiler;
- Worktop features seven cooking zones;
- Continuous grating grids;
- Wok ring adaptor;
- Espresso trivet.

This appliance is certified by Star-K to meet strict regulations in conjunction with specific instructions found on www.star-k.org

Range Features: RN482...; RD482...



A. Worktop Profile

A.1 If supplied with backguard

A.2 If supplied with island trim

B. Worktop

1. Left front power burner 18000 Btu/h
2. Left rear large burner 11000 Btu/h
3. Center front small burner 3600 Btu/h
4. Center rear medium burner 6500 Btu/h
5. Electric griddle 1150W
6. Right front power burner 18000 Btu/h
7. Right rear medium burner 6500 Btu/h

C. Control Panel

8. Left front power burner control knob
9. Left rear large burner control knob
10. Center small burner zone control knob
11. Center rear medium burner control knob

12. Rotary switch (light, convection, convection + light)

13. Thermometer

14. Main oven temperature control knob

15. Griddle control knob

16. Auxiliary oven temperature control knob

17. Right front power burner control

18. Right rear medium burner control

D. Main Oven (with six racks position)

19. Wire shelves (x2)

20. Telescopic glide shelf

21. Enamelled baking tray

22. Trivet

E. Auxiliary Oven (with six racks position)

23. Wire shelf



19



20



21

22



23

Range Features: RN483...



A. Worktop Profile

- A.1 If supplied with backguard
- A.2 If supplied with island trim

B. Worktop

- 1. Left front induction zone max 2100W
- 2. Left rear induction zone max 2100W
- 3. Center front induction zone max 2100W
- 4. Center rear induction zone max 2100W
- 5. Electric griddle 1150W
- 6. Right front power burner 18000 Btu/h
- 7. Right rear medium burner 6500 Btu/h

C. Control Panel

- 8. Left front induction zone control knob
- 9. Left rear induction zone control knob
- 10. Center front induction zone control knob
- 11. Center rear induction zone control knob

- 12. Rotary switch (light, convection, convention + light)
- 13. Thermometer
- 14. Main oven temperature control knob
- 15. Griddle control knob
- 16. Auxiliary oven temperature control knob
- 17. Right front power burner control
- 18. Right rear medium power burner control

D. Main Oven (with six racks position)

- 19. Oven wire shelves (x2)
- 20. Telescopic glide shelf
- 21. Enamelled baking tray
- 22. Trivet

E. Auxiliary Oven (with six racks position)

- 23. Oven wire shelf

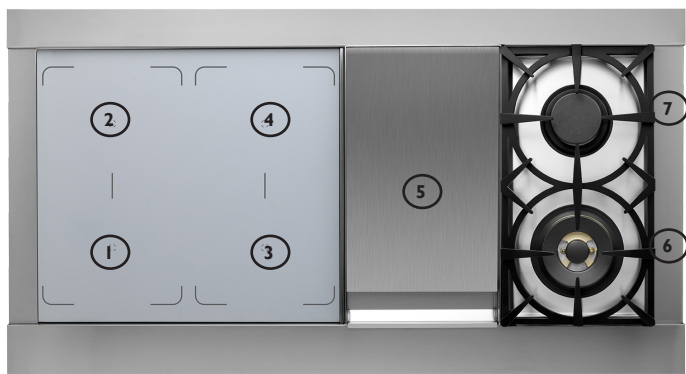

19



20



21

22



23

Surface Operation

Surface Cooking Tips

Your range is equipped with a variety of different sized surface burners. Below is a guide for which burners work best for certain cooking applications:

Burner	Use
front left and front right 18.000 BTU	Quick water boiling Deep-fat frying in large utensil
front right simmer 750 BTU	Melting small quantities Steaming rice Simmering sauces
central front 3.600 BTU	Melting large quantities Low-temperature frying (eggs, etc.) Simmering large quantities Heating milk, cream sauces, gravies, and puddings
central rear and right rear 6.500 BTU	Sauteing and browning, braising, and pan frying Maintaining slow boil on large quantities
front rear 11.000 BTU	High-temperature frying Pan broiling Maintaining fast boil on large quantities

Note: models with induction zones are provided only with the burners on the right

Use low or medium flame heights when cooking in vessels that are poor conductors of heat, such as glass, ceramic, and cast-iron. Reduce the flame height until it covers approximately 1/3 of the cooking vessel diameter. This will ensure more even heating within the cooking vessel and reduce the likelihood of burning or scorching the food.

- Reduce the flame if it is extending beyond the bottom of the cooking vessel. A flame that extends along the sides of the vessel is potentially dangerous, heats the utensil handle and kitchen instead of the food, and wastes energy.
- Reduce the flame height to the minimum level necessary to perform the desired cooking process. Remember that food cooks just as quickly at a gentle boil as it does at a rolling boil. Maintaining a higher boil than is necessary wastes energy, cooks away moisture, and causes a loss in food flavor and nutrient level.
- The minimum pot or pan (vessel) diameter recommended is 6" (15 cm) on the larger burners. Pots or pans as small as 4" (10 cm) should be used on the smaller burners.

Surface Operation

Cooking Vessels

Each cook has his or her own preference for the particular cooking vessels that are most appropriate for the type of cooking being done. Any and all cooking vessels are suitable for use in the range and it is not necessary to replace your present domestic vessels with commercial cookware. This is a matter of personal choice. As with any cookware, yours should be in good condition and free from excessive dents on the bottom to provide maximum performance and convenience. Please refer to our advice on pages 31-32 for special tips and advice on the suitable cookware to be used for induction cooking.



Note: When using big pots and/or high flames, it is recommended to use the front burners. There is more room in the front and potential cleanup at rear of appliance due to staining or discoloration will be minimized.

Burners operation

Lighting Burners



All burners are ignited by electric ignition. There are no open-flame, “standing” pilots.

Work-top Burners

To light the surface burners, push and turn the appropriate control knob anticlockwise to maximum flow position  . This control is both a gas valve and an electric switch.

When gas is permitted to flow to the burners, the electric igniters start sparking.



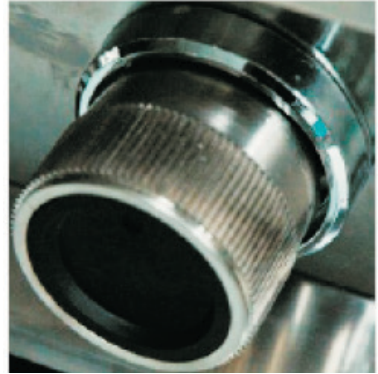

On all surface igniters you should hear a “clicking” sound. If you do not, turn off the control and check that the unit is plugged in and that the fuse or circuit breaker is not blown or tripped.







Within a few moments, enough gas will have traveled to the burner to light. When the burner lights, turn the burner control to any position from maximum   to minimum  flow position to adjust the flame size. Setting the proper flame height for the desired cooking process and selecting the correct cooking vessel will result in superior cooking performance, while also saving time and energy.











Power burner with simmer

The range is provided with a power burner with simmer; a special burner featuring a very high flexible range of cooking settings: from 750 Btu/h for simmering, melting or steaming rice, to 18000 Btu/h for the most powerful performance.

To light the surface burners, push and turn the appropriate control knob anticlockwise to maximum power of inner ring.    

The inner ring lights at its maximum power. Then you can continue to use only the inner ring and adjust the flame power by turning the control knob from   to  position. If you need to light on also the external ring, continue to turn anticlockwise the knob and make a little pressure on it in order to cross the lock located after the minimum power position of internal ring. The external burner lights on; flame is adjustable turning the knob from   to  position.

Worktop burner knob + simmer

OFF	= Closed position
   	= “Full on” position internal ring
   	= “Full on” position external ring

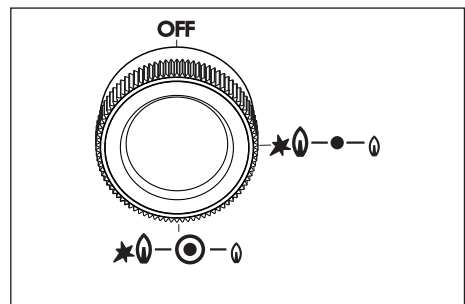

Electric griddle

Griddle/Simmer Plate (on applicable models)

The optional 1150W griddle is constructed of machined steel with a blanchard finish and is uniquely designed to offer excellent cooking performance as well as easy clean up. The griddle is equipped with an electronic thermostat to maintain an even temperature across the griddle once the desired temperature has been set.

The griddle has a power “ON” indicator light which glows when the griddle thermostat has been turned on. This will cycle on and off as needed to indicate the thermostat is maintaining the selected temperature. Before the griddle is used it is important to season the griddle. This seasoning process will change the appearance of the griddle plate. However, it will also prevent food from sticking and protect the surface from moisture.

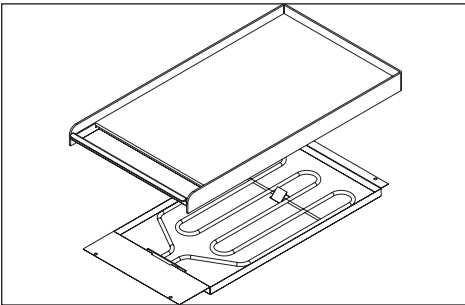

Seasoning the Griddle Before the First Use

- Scrub the griddle plate with a mixture of one quart warm water and 1/4 cup white vinegar, using a blue Scotch-Brite™ pad. Dry thoroughly.
- Wash griddle with warm, soapy water. Rinse off and dry thoroughly.
- Season griddle by thinly coating the surface with approximately 1/2 to 1 teaspoon unsalted vegetable oil. Apply to entire griddle using a paper towel or clean cloth. Let oil sit on griddle for approximately 1 hour and then wipe with a clean cloth or paper towel to absorb any residual oil. The griddle is now ready to be used.

The griddle is equipped with a removable drip tray. After using the griddle, extract the drip tray, and dispose its content, paying attention to avoid spillages.

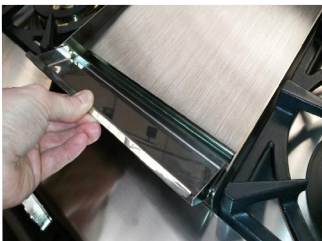

Electric griddle

Electric griddle knob range 48''

OFF	= Closed position
from 1 to 7 positions	= Griddle temperatures

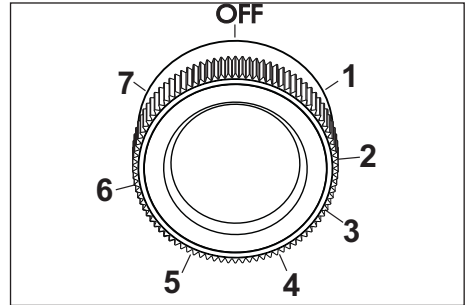

Griddle/Simmer Plate Operation

- Turn the griddle control knob clockwise to the desired temperature setting. The power "ON" indicator light will glow indicating the griddle thermostat is on.
- Use liquid cooking oil or butter for eggs, pancakes, French toast, fish and sandwiches to prevent sticking.
- Routinely scrape loose food particles with a metal spatula during cooking to make the cleanup easier and to avoid the particles mixing with the food.
- To turn the griddle off, turn the thermostat knob clockwise to the "OFF" position.
- ALWAYS turn to the "OFF" position when not in use and lower the heat between cooking loads.

Setting the desired temperature

The Griddle can be setted at the desired temperature from 180-200°F to 550-580°F by rotating the control knob from 1 to 7 position.

The correspondence of temperatures is listed below.

Knob pos.	1	2	3	4	5	6	7
Temp.	180-200	280-300	330-350	380-400	430-450	480-500	550-580

Induction

Induction worktop introduction

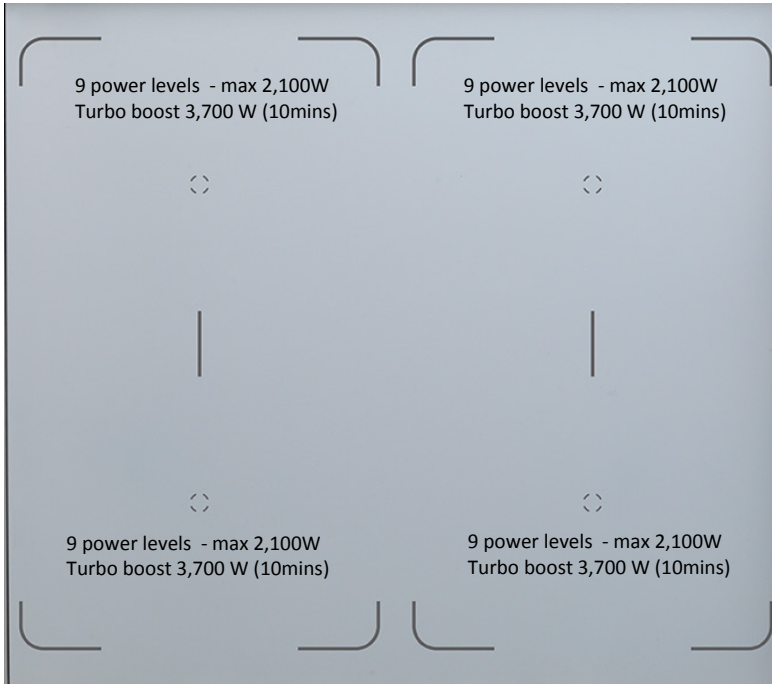

2 couples of octagonal inductors 220x184mm (left front and rear + right front and rear) Max available power of 3,700 W (16 Amp) one each side :TOTAL 7400W on 2 phases (16+16 amp) – The electronic board manages the available power on each side automatically, giving priority to the last input.

Important! Disconnect the appliance from the mains if the ceramic glass is cracked and contact Customer Care. Metallic objects such as knives, forks, spoons and lids should not be placed on the worktop surface since they can get hot.

Induction



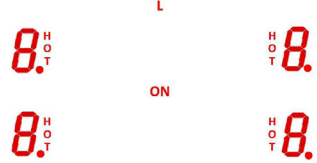

Cooking zones display

The ceramic worktop is fitted with induction cooking zones.

These zones are controlled by separate dials positioned on the control panel below.



At the front, is the display for the cooking zones (one for each zone). Each zone display is activated by its corresponding control dial and displays

OFF	= Cooking zone Off (not activated)
ON	= Cooking zone On (activated but not operating). If all the zones are in zero setting, the display switches off automatically (cooking zones Off) after about 10 second
1-9	= Power levels
	= Accelerated heat-up
	= PowerBoost feature
H O T	= Hot Surface indicator
	= Pan detection indicator
	= Childlock
	= Bridge activated

Note: each lit figure refers to the relevant cooking zone

Using your induction worktop

Control dials

Each cooking zone is activated by a separate control dial positioned on the control panel. The functions are arranged on the actual dial itself. If a cooking zone is not turned off ('0' position) the electronic system automatically switches it off after a pre-set time ranging from 90 minutes to 6 hours, depending on the power setting.

OFF	Cooking zone Off (not activated)
ACC	= Accelerated heat-up
POW	= Turbo Boost/Bridge
from 1-9	= Induction power levels
MELT WARM SIMM	= Induction special functions: Melting, Warming, Simmering



Power level

Turn the dial clockwise to set the desired power level between 1 (minimum) and 9 (maximum). The power level can be modified at any time by turning the dial clockwise or anti-clockwise to a different setting. The cooking zone display shows the selected level.

Using your induction worktop

Cooking guidelines

Heat settings

The settings below are guidelines only. The exact setting will depend on several factors, including your cookware and the amount you are cooking. Experiment with the worktop to find the settings that best suit you. In general, the lower heat settings offer a more gradual control, whereas the higher heat settings have a more pronounced step change in power.

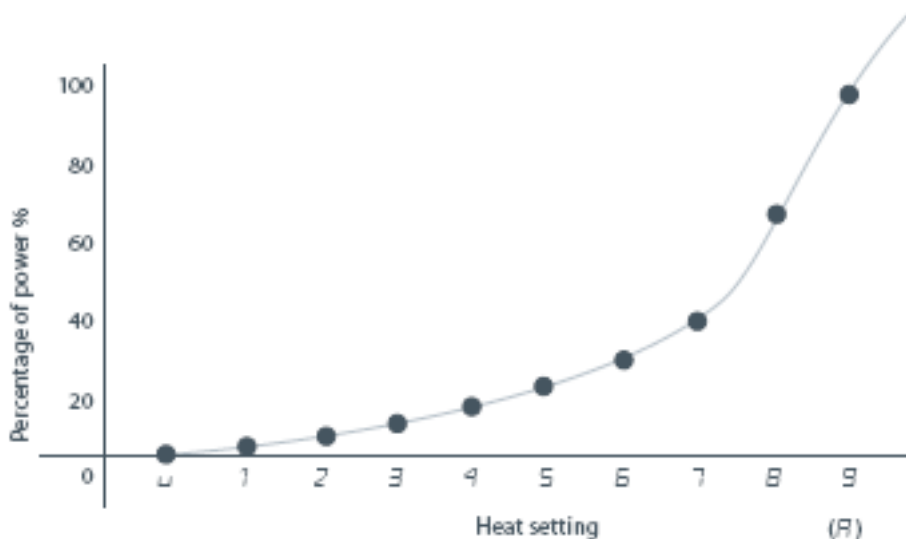

Heat setting	Suitability
1	delicate warming for small amounts of food melting chocolate, butter, and foods that burn quickly
3	gentle simmering cooking rice
5	rapid simmering pancakes
7	sautéing cooking pasta
9	stir-frying searing
P	boiling water

Using your induction worktop

Child Lock

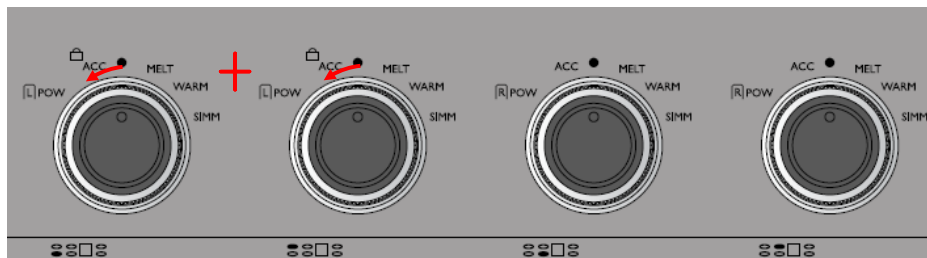

The child lock function can be enabled by turning the first two knobs from the left simultaneously into the left overwind position “ACC”. They need to be held in that position for a least 2s. The activation will be displayed on all 7 segment displays. If the knobs are not hold in the OWL position for long enough the CL will not be enabled / displayed. If the CL function is active the cooking zones can not be switched on even if the knobs are turned in a cooking level position other than zero. The CL function has no working time limitation. A mains power failure which exceeds the specified hold-up time will deactivate the CL function. If at the event of a mains power failure any knob is in a position different from zero no poweroutput will take place. In order to deactivate the CL function repeat the same procedure as for activating. After unlocking all knobs have to be turned back in the zero position (if any knob was in a position different from zero). The control is then off and can be operated as expected.

Using your induction worktop

Residual Heat indicator



The cooking level of a cooking zone can be selected by turning the knob to the according position even if no pot is present. The output of power starts automatically as soon as a appropriate pot is put on the cooking zone. If the knob position will be changed the display shows the according power level.

If no pot is being detected the display changes to the shown “pot missing” symbol after a short time. This symbol will be shown until a appropriate pot is put on the cooking zone or the maximum time of 10 minutes expired.

The same applies if the pot is removed during normal cooking.

After 10 minutes without detected pot the cooking zone switches off automatically and can only be activated again after returning the knob into the zero position.

Pot diameter detection



The cooking level of a cooking zone can be selected by turning the knob to the according position even if no pot is present. The output of power starts automatically as soon as a appropriate pot is put on the cooking zone. If the knob position will be changed the display shows the according power level.

If no pot is being detected the display changes to the shown “pot missing” symbol after a short time. This symbol will be shown until a appropriate pot is put on the cooking zone or the maximum time of 10 minutes expired.

The same applies if the pot is removed during normal cooking.

After 10 minutes without detected pot the cooking zone switches off automatically and can only be activated again after returning the knob into the zero position.

Limits of cookware detection (cast iron plate is detected; pots/pans can differ):

- used in single mode - 90mm
- used in bridge mode (pot/pan on just one zone) - 110mm the other zone is not heating up the pot/pan and shows the missing pot symbol
- used in bridge mode (pot/pan on both zones) - 220mm depends on the distance between the two inductors
- Recommendation for the manual - plus 25mm

Choosing the right cookware

Important!

- Only use cookware with a base suitable for induction cooking. Look for the induction symbol on the packaging or the bottom of the pan.
- You can check whether your cookware is suitable by carrying out a magnet test. Move a magnet towards the base of the pan. If it is attracted, the pan is suitable for induction.
- If you do not have a magnet:
 1. Put some water in the pan you want to check.
 2. Place a suitable pan on the cooking zone you wish to use. Make sure the bottom of the pan and the surface of the cooking zone are clean and dry. Turn on the cooking zone.
 3. If does not flash in the display and the water is heating, the pan is suitable.Note: If the pan detection symbol does appear on the display, your pan is not suitable and the worktop will not operate. After 10 minutes without detecting any pan, the cooking zone switches off automatically and can only be switched on after the control dial has been returned to "0" (Off).
- Cookware made from the following materials is not suitable: pure stainless steel, aluminium or copper without a magnetic base, glass, wood, porcelain, ceramic, earthenware. **Do not use cookware with jagged edges or a curved base.**

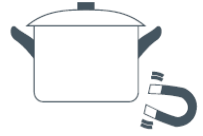

Make sure that the base of your pan is smooth, sits flat against the glass, and is approximately the same size as the cooking zone. Always centre your pan on the cooking zone.

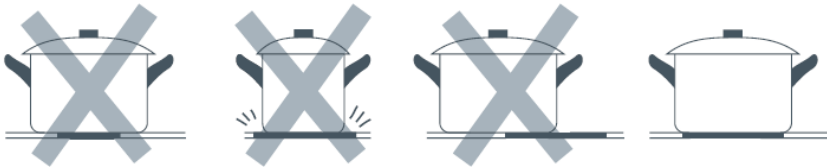

Always lift pans off the worktop— do not slide, or they may scratch the glass.

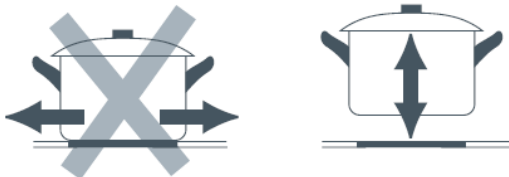

Choosing the right cookware

Important!

the cooking zones will not operate if the pan diameter is too small (will appear on the cooking zone display). To correctly use the cooking zones follow the indications given in the following table.

Induction cooking zone	Minimum pan diameter recommended	Maximum pan diameter recommended
Single zone mode	110 mm	300 mm
Bridge mode	220 mm	220x370 mm

Important: When bridge mode is activated, if one zone is not covered by cookware, the pot missing symbol starts to flash and in a few seconds the bridge function stops working.

Note: some types of pans can cause noise when used on an induction cooking zone. This noise does not mean any failure on the appliance and does not influence the cooking

Using induction worktop special features

Accelerated Heat-up feature



This feature is available on all the cooking zones.

Turn the control dial anti-clockwise to the 'A' setting and then release the dial (after the 'beep'); the symbol lights up on the corresponding cooking zone display. Within 5 seconds turn the dial to the desired power level (between 1 and 9); once a setting has been selected, and the chosen power level will flash in alternation on the control panel display.

This feature allows the cooking zone to operate at the maximum power (100%) for a time proportional to the selected power level; after this time the cooking zone will operate at the selected level. While this feature is operating it is possible, at any time, to increase the selected power level but it is not possible to decrease the power.

Note: If removing the pan from the cooking zone before the programme has been completed, the Auto Heat-reduce feature will be completed with the remaining time if the pan is put back on the cooking zone within 10 minutes.



To activate accelerated heat-up turn the knob anticlockwise in the left overwind position "ACC" and hold the knob in that position for 2 seconds. Then, within the next 10 sec, select a cooking level.

The 7 segment display alternates between "A" and the selected cooking level until it will be reached.

The Auto Heat-reduce feature can be disabled by turning the dial anti-clockwise to a lower power level, turning the dial to the '0' (Off) position or by selecting the Power-Boost feature.

Using induction worktop special features

PowerBoost feature



This feature is available on the front left/rear right zones only.

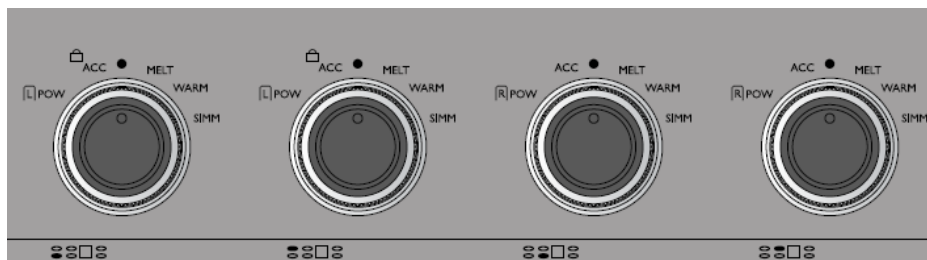

To activate the boost function turn the knob in the right overwind position “POW”. The symbol P will be displayed on the according 7 segment display. After 10 minutes the boost function will be automatically switched off and the “P” is not shown on the display anymore.

Important!

The PowerBoost feature is not suitable for use with non water based cooking. Do not use this function for heating oil (e.g. deep fat frying). The power density may be too high and it could damage the cookware.

Using induction worktop special features

Bridge

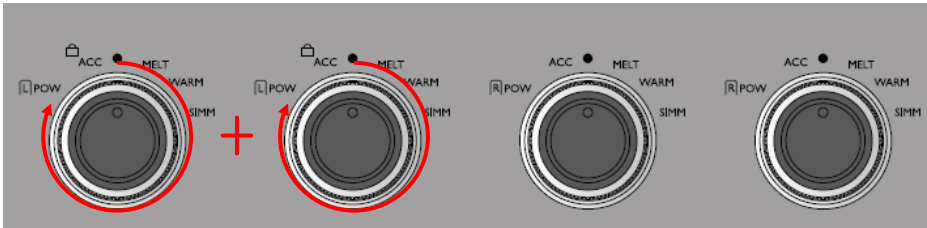
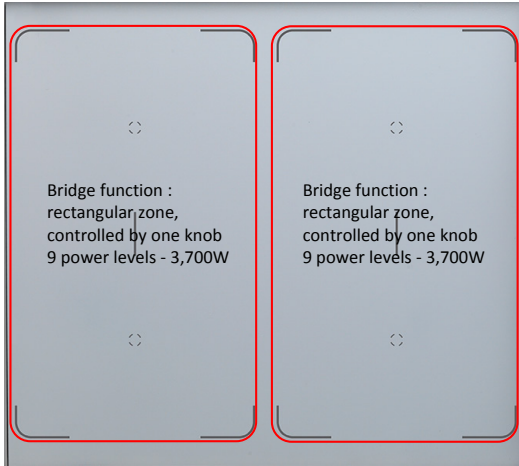

Two cooking zones bridged behave like one cooking zone and can also be controlled like only one. One of the two cooking zones (the rear) is the “slave cooking zone” the other (front) is the “master cooking zone”. The knobs controlling the two cooking zone which should be bridged must be simultaneously turned in the right overwind position (POW). They need to be hold in that position for a least 2s. Then the knob for the “slave cooking zone” has to be left on level 9 position. The display belonging to the slave cooking zone shows the following bridge symbol.

The “master cooking zone” knob will then control the rectangular cooking area :

9 power levels - max 3,700 W

Using induction worktop special features

Melting

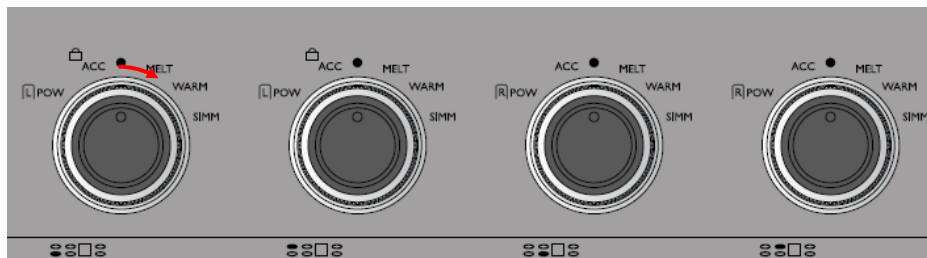

Melting function keeps the temperature at the bottom of the pot to approx 42°C – 110°F.

Tolerance +/- 5°C – 40°F

Warming

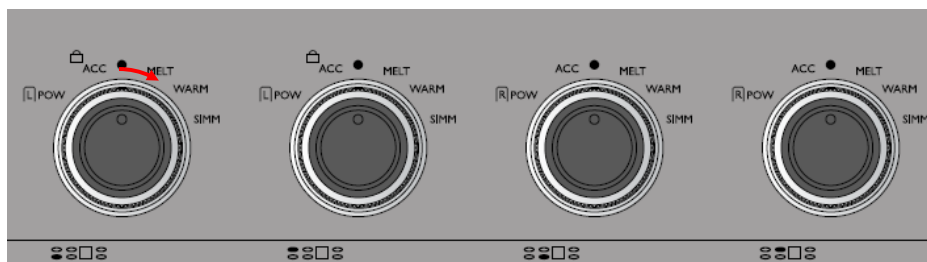

Melting function keeps the temperature at the bottom of the pot to approx 70°C – 155°F.

Tolerance +/- 5°C – 40°F

Using induction worktop special features

Simmering



Melting function keeps the temperature at the bottom of the pot to approx 95°C – 200°F.

Tolerance +/- 5°C – 40°F

Oven Functions and Setting

Main Oven

BAKE (Natural Airflow Bake)

Use this setting for baking, roasting, and casseroles.

CONVECTION BAKE

Use this setting to bake and roast foods at the same time with minimal taste transfer.

BROILING

Use this setting for broiling dark meats at 1" thickness or less where rare or medium doneness is desired.

DEFROST

Use this function to defrost foods.

Auxiliary Oven

BAKE (Natural Airflow Bake)

Use this setting for baking, roasting, and casseroles.

Ovens Features

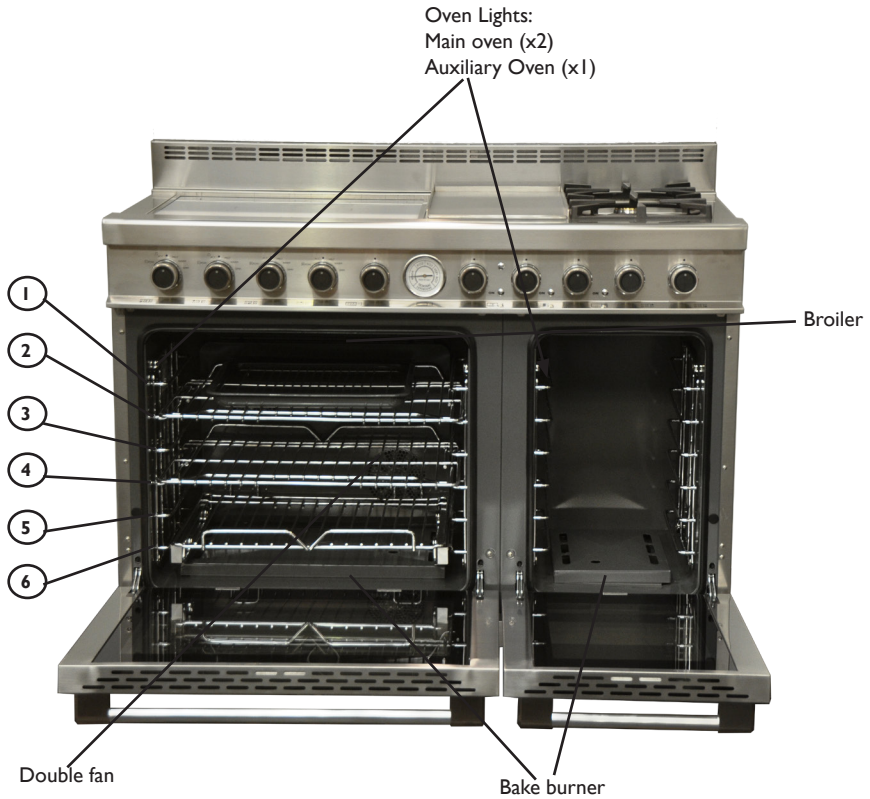

Rack Positions 48" ranges

Main oven is equipped with three oven racks, auxiliary oven with one. All ovens have six rack positions.

Position 6 is the farthest from the oven bottom. Position 1 is the closest to the oven bottom. The racks can be easily removed and arranged at various levels.

For better results with conventional baking, **DO NOT** use more than one rack at a time. It is also recommended, when using two racks, to bake with the racks in positions 2 and 4 or positions 3 and 5.

Using the Ovens

Oven Preheat

The oven temperature can reach a temperature of aprox 400°F in 10 minutes in static function. Please consider this during the pre-heat process of the oven.

Conventional vs Convection Cooking

Because of variations in food density, surface texture and consistency, some foods may be prepared more successfully using the conventional bake setting. For this reason, conventional baking is recommended when preparing baked goods such as custard. The user may find other foods that are also prepared more consistently in conventional bake. It is recommended to use this function for single-rack baking.

Analog Thermometer

This is not an electrical device, so it works even if the range is not connected to the mains.

This thermometer shows roughly the inner temperature of the main oven when is working and it can have a deviation according to the type of cooking and the type of oven function. It isn't a control of inner temperature.

The control of the temperature is always done by thermostat activated by knob.

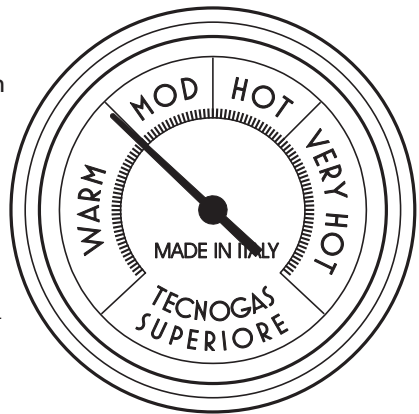

Baking

BAKE

(Natural Airflow Bake)

Full power heat is radiated from the bake burner in the bottom of the oven cavity and is circulated with natural airflow. This function is recommended for single rack baking. Many cook books contain recipes to be cooked in the conventional manner. Conventional baking is suitable for dishes that require a high temperature. Use this setting for baking and casseroles.

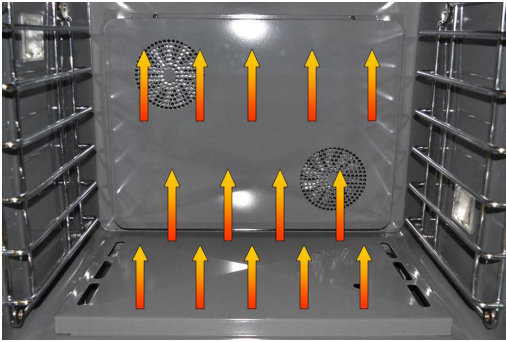

BAKE (Main oven)



BAKE (Auxiliary oven)

To Use BAKE Function

1. Arrange the oven rack in the desired position before turning the oven on and close the door.
2. Push and hold the oven control knob for at least one second. Release and turn it anticlockwise, setting the desired temperature. This sequence must be performed within seven seconds. If you hear a clicking sound while lighting up the oven, this is appropriate.

Note:

If the oven does not light up after five attempts, open the oven door and let the gas out; for your safety, open the window of the kitchen.

Baking

Baking Tips

- Make sure the oven racks are in the desired position before you turn on the oven.
- **DO NOT** open the door frequently during baking. Look through the door window to check doneness whenever possible. If you must open the door, the best time is during the last quarter of the baking time.
- Bake to the shortest time suggested and check for doneness before adding more time. For baked food, a stainless steel knife placed in the center of the product should come out clean when done.
- Use the pan size and type recommended by the recipe to ensure best results. Cakes, quick breads, muffins, and cookies should be baked in shiny, reflective pans for light, golden crusts. Avoid the use of old, darkened pans. Warped, dented, stainless steel and tin-coated pans heat unevenly and will not give uniform baking results.

Food	Pan size	Single rack position	Temperature	Time (min)
ENTREES				
Eggs rolls	Cookie sheet	3 or 4	400F°(204°C)	25-30
Fish sticks	Cookie sheet	3 or 4	425°F(218°C)	10-15
Lasagna, frz	Cookie sheet	3 or 4	375F°(191°C)	55-60
Pot pie	Cookie sheet	3 or 4	400F°(204°C)	35-40
Gr. peppers stuffed	13"x 9"	3 or 4	375F°(191°C)	60-70
Quiche	9" round	3 or 4	400F°(204°C)	25-30
Pizza, 12"	Cookie sheet	3 or 4	400F°(204°C)	15-20
Mac. & cheese, frz	Cookie sheet	3 or 4	375F°(191°C)	35-40
VEGETABLES				
Baked potatoes	On rack	3 or 4	375F°(191°C)	60-65
Spinach souffle	1 qt. casserole	3 or 4	350F°(177°C)	45-50
Squash	Cookie sheet	3 or 4	375F°(191°C)	50-55
French fries	Cookie sheet	3 or 4	425°F(218°C)	20-25

***Note:** The above information is given as a guide only

Baking

Food	Pan size	Single rack position	Temperature	Time (min)
BREADS				
Biscuits	Cookie sheet	3 or 4	400F°(204°C)	10 -12
Yeast loaf	Loaf pan	3 or 4	375F°(191°C)	30-35
Yeast rolls	Cookie sheet	3 or 4	400F°(204°C)	12-15
Nut bread	Loaf pan	3 or 4	375F°(191°C)	30-35
Combread	8"x 8"	3 or 4	400F°(204°C)	25-30
Gingerbread	8"x 8"	3 or 4	350F°(177°C)	35-40
Muffins	Muffin tin	3 or 4	375F°(191°C)	15-20
Corn muffins	Muffin tin	3 or 4	375F°(191°C)	15-20
CAKE				
Angel food	Tube pan	3 or 4	375F°(191°C)	35-45
Bundt	Tube pan	3 or 4	350F°(177°C)	45-55
Cupcakes	Muffin pan	3 or 4	350F°(177°C)	16-20
Layers, sheet	13"x 9"	3 or 4	350F°(177°C)	40-50
Layers, two	9" round	3 or 4	350F°(177°C)	30-35
Pound	Loaf pan	3 or 4	350F°(177°C)	60-65
COOKIES				
Brownies	13"x 9"	3 or 4	350F°(177°C)	25-30
Choc.chip	Cookie sheet	3 or 4	375F°(191°C)	12-15
Sugar	Cookie sheet	3 or 4	375F°(191°C)	10-12
PASTRY				
Cream puffs	Cookie sheet	3 or 4	400F°(204°C)	30-35
PIES				
Crust, unfilled	9" round	3 or 4	400F°(204°C)	10-12
Crust, filled	9" round	3 or 4	350F°(177°C)	55-60
Lemon meringue	9" round	3 or 4	350F°(177°C)	12-15
Pumpkin	9" round	3 or 4	350F°(177°C)	35-40
Custard	6-4 oz cups	3 or 4	350F°(177°C)	35-40

Baking

Solving Baking Problems

Baking problems can occur for many reasons. Check the chart below for the causes and remedies for the most common problems. It is important to remember that the temperature setting and cooking times you are accustomed to using with your previous oven may vary slightly from those required with this oven. If you find this to be true, it is necessary for you to adjust your recipes and cooking times accordingly.

Common Baking Problems/Remedies

Problems	Cause	Remedy
Cakes burned on the sides or not done in center	1. Oven was too hot 2. Wrong pan size 3. Too many pans	1. Reduce temperature 2. Use recom. pan size 3. Reduce no. of pans
Cakes crack on top	1. Batter too thick 2. Oven too hot 3. Wrong pan size	1. Follow recipe Add liquid 2. Reduce temperature 3. Use recom. pan size
Cakes are not level	1. Batter uneven 2. Oven or rack not level 3. Pan was warped	1. Distribute batter even 2. Level oven or rack 3. Use proper pan
Food too brown on botton	1. Oven door opened too often 2. Dark pans being used 3. Incorrect rack position 4. Wrong bake setting 5. Pan too large	1. Use door window to bot- tom check food 2. Use shiny pans 3. Use recom. rack position 4. Adjust to conventional or convection setting as needed 5. Use proper pan
Food too brown on top	1. Rack position too high 2. Oven not preheated 3. Sides of pan too high	1. Use recom. rack position 2. Allow oven to preheat 3. Use proper pans
Cookies too flat	1. Hot cookie sheet	1. Allow sheet to cool betwe- en batches
Pies burned around edges	1. Oven too hot 2. Too many pans used 3. Oven not preheated	1. Reduce temperature 2. Reduce no. of pans 3. Allow oven to preheat
Pies too light on top	1. Oven not hot enough 2. Too many pans used 3. Oven not preheated	1. Increase temperature 2. Reduce no. of pans 3. Allow oven to preheat

Convection Bake

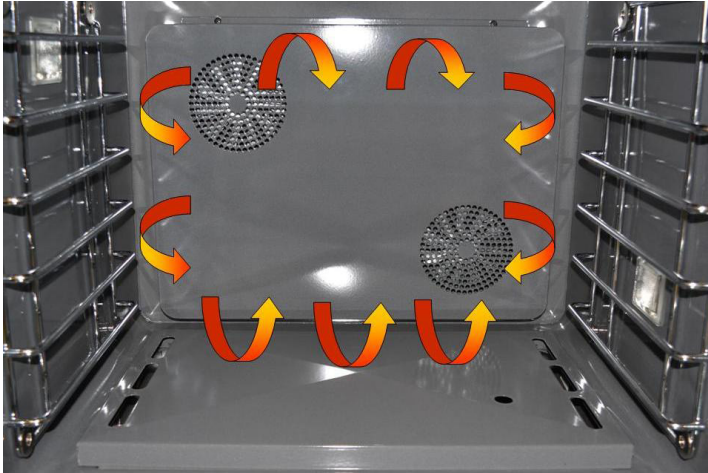

CONVECTION BAKE

Heat is radiated from the bake burner in the bottom of the oven cavity. The heated air is circulated by the fans in the rear of the oven providing a more even heat distribution. Multiple rack use is possible for the largest baking job. When roasting, cool air is quickly replaced searing meats on the outside and retaining more juices and natural flavor on the inside with less shrinkage. This even circulation of air equalizes the temperature throughout the oven cavity and eliminates the hot and cold spots found in conventional ovens.



CONVECTION BAKE

To Use CONVECTION BAKE Function (only on main oven)

1. Arrange the oven rack in the desired position before turning the oven on and close the door.
2. Push and hold the oven control knob for at least one second. Release and turn it anticlockwise, setting the desired temperature. This sequence must be performed within seven seconds. If you hear a clicking sound while lighting up the oven, this is appropriate.
3. Set the rotary switch knob to "Convection" 
4. In order to switch on the oven light during convection bake, set the rotary switch knob to "Oven light on+fan". 

Note:

If the oven does not light up after five attempts, open the oven door and let the gas out; for your safety, open the window of the kitchen.

Convection Bake

Convection Cooking Tips (only on main oven)

Convection cooking is a cooking technique which utilizes fan-forced air to circulate throughout the entire oven cavity creating the optimum cooking environment. Cooking with convection is intended when performing multi-rack baking and for heavier foods. Below are some tips which will allow you to get the best results out of your oven when cooking with convection.

- As a general rule, to convert conventional recipes to convection recipes, reduce the temperature by 25°F (10°C) when using a convection cooking function.
- Cooking times for standard baking and convection baking will be the same. However, if using convection to cook a single item or smaller load, then it is possible to have 10-15% reduction in cooking time. (Remember convection cooking is designed for multi-rack baking or cooking large loads.)
- If cooking items which require longer than 45 minutes, then it is possible to see a 10-15% reduction in cooking time.
- A major benefit of convection cooking is the ability to prepare foods in quantity. The uniform air circulation makes this possible. Foods that can be prepared on two or three racks at the same time include: pizza, cakes, cookies, biscuits, muffins, rolls, and frozen convenience foods.
- For three-rack baking, use any combination of rack positions 2, 3, 4, and 5. For two-rack baking, use rack positions 2 and 4 or positions 3 and 5. Remember that the racks are numbered from bottom to top.

Pan Placement Tips

- When using large (15" x 13") flat pans or trays that cover most of the rack, rack positions 2 or 3 produce the best results.
- When baking on more than one rack, it is recommended to use the 3rd and 5th position for more consistent even baking.
- Stagger pans in opposite directions when two racks and several pans are used in conventional bake. If possible, no pan should be directly above another.
- Allow 1 to 2 inches of air space around all sides of each pan for even air circulation.

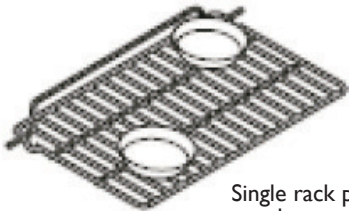

Single rack pan placement

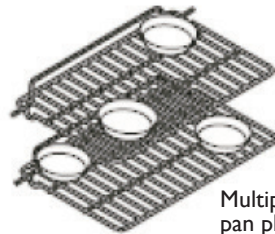

Multiple rack pan placement

Defrost

Air is circulated by motorized fan in the rear of the oven. The fan accelerates natural defrosting of the food without heat. To avoid sickness and food waste, **DO NOT** allow defrosted food to remain in the oven for more than two hours.

1. Place the frozen food on a baking sheet.
2. Turn the selector to  and set the temperature to “OFF”.



WARNING

To avoid sickness and food waste, **DO NOT** allow defrosted food to remain in the oven for more than two hours.

Broiling

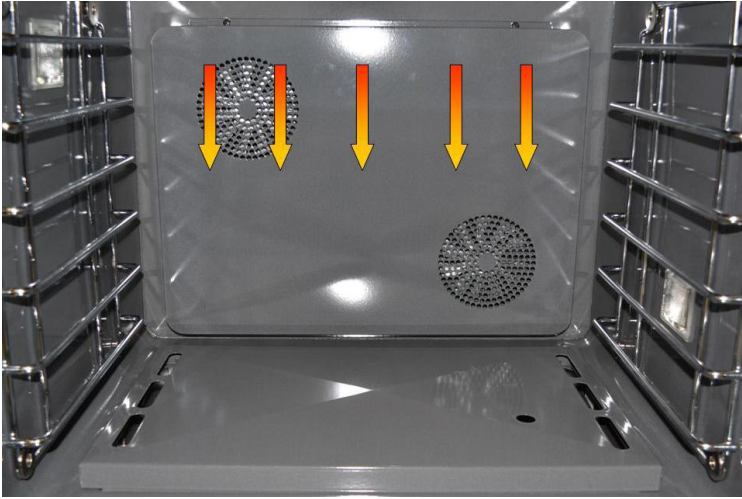

BROIL

Heat radiates from the broiler located at the top of the oven cavity. The distance between the foods and the broil elements determines broiling speed. For “fast” broiling, food may be as close as 2 inches (5 cm) to the broil element. “Fast” broiling is best for meats where rare to medium doneness is desired. Use this setting for broiling small and average cuts of meat.

Broiling Instructions

Broiling is a dry-heat cooking method using direct or radiant heat. It is used for small, individualized cuts such as steaks, chops, and patties. Broiling speed is determined by the distance between the food and the broil element.

Choose the rack position based on desired results.

To Use Broil

1. Arrange the oven rack in the desired position before turning the oven on and close the door.
2. Push and hold the oven control knob for at least one second. Release and turn it clockwise to the broil position. This sequence must be performed within seven seconds. If you hear a clicking sound while lighting up the broil, this is appropriate.
3. In order to switch on the oven light during broiling function, set the rotary switch knob to “oven light on”. ⚙️

NOTE: IF YOU SELECT THE CONVECTION FUNCTION ACTIVATING THE ROTARY SWITCH KNOB, THE FANS WILL NOT WORK! THIS MUST BE CONSIDERED APPROPRIATE.

Broiling

Broiling Tips

- **ALWAYS** use the enamelled tray and trivet for broiling. They are designed to provide drainage of excess liquid and fat away from the cooking surface to help prevent splatter, smoke, and fire.
- To keep meat from curling, slit fatty edge.
- Brush chicken and fish with butter several times as they broil to prevent drying out. To prevent sticking, lightly grease broiler tray.
- Broil on first side for slightly more than half the recommended time, season, and turn. Season second side just before removing.
- **ALWAYS** pull rack out to stop position before turning or removing food.
- Use tongs or a spatula to turn meats. **NEVER** pierce meat with a fork, as this allows the juices to escape.
- Remove the enamelled tray from the oven when you remove the food. Drippings will bake onto the pan if it is left in the heated oven after broiling.

Rack Positions for Broiling

Note: Position 1 is the closest to the broiler and position 6 is the closest to the oven bottom.



Broiling

Broiling Chart

Type and Cut of Meat	Weight	Setting	Rack	Time (min)
BEEF				
Siloin 1"				
Rare	12 oz	Broil	3	4
Medium	12 oz	Broil	3	5
Well done	12 oz	Broil	3	6
T-Bone 3/4"				
Rare	10 oz	Broil	3	4
Medium	10 oz	Broil	3	6
Well done	10 oz	Broil	3	8
Hamburger 1/2"				
Medium	1/4 lb.	Broil	3	6
Well done	1/4 lb.	Broil	3	8
CHICKEN				
Bnls breast 1"	1/2 lb.	Broil	3	15
Bone-in breast	2-3 lbs. total	Broil	1	22
Chicken pieces	2-3 lbs. total	Broil	3	22
HAM				
Ham slice 1"	1 lb.	Broil	3	10
PORK				
Bacon		Broil	2	3
FISH				
Salmon steak	1 lb.	Broil	2	8
Filletts	1 lb.	Broil	2	8

Note: The above information is given as a guide only.

Care and cleaning

Important!

Before you start cleaning your range, please:

- Read these cleaning instructions and the 'Safety and warnings' section at the start of this user guide.
- Turn the range off.
- Make sure the range is a safe temperature to touch.
- Do not use a steam cleaner.
- Do not keep flammable substances in the oven.

General advice

- Wipe down the worktop and wipe out the oven after every use.
- Wipe up spills. Avoid leaving alkaline or acidic substances (such as lemon juice or vinegar) on the surfaces.
- Do not use cleaning products with a chlorine or acidic base (ie citrus-based cleaners).

Cleaning the outside of the range

Important!

- Do not use abrasive cleaners, cloths or pads on the outside surfaces.
- Immediately wipe off any caustic cleaners if they are spilled onto the oven door handle.

Wipe the outside surfaces often, using warm water and a mild household detergent. The stainless steel may also be cleaned with a suitable cleaner and polish.

Note: if you choose to use a commercial stainless steel cleaner, please read the label to make sure it does not contain chlorine compounds as these are corrosive and may damage the appearance of your range.

Cleaning and Maintenance

Caring for your worktop

Important!

- Some heavy-duty and nylon scourers can scratch the ceramic glass of your worktop. Always read the label to check if your scourer is suitable for cleaning ceramic glass worktops.
- Use ceramic glass cleaner on the worktop while it is warm to touch. Rinse and wipe dry with a clean cloth or paper towel. The worktop may become stained if cleaning residue remains.
- Remove any food, spillovers or grease from the worktop while it is still warm using a razor blade scraper suitable for ceramic glass surfaces.
- Do not use knives or any other sharp object for cleaning. Take extra care to avoid damaging the seal at the edges of the ceramic glass surface. Do not use cleaning products with a chlorine or acidic base.

Metallic stains

Copper-based or aluminium cookware may cause metallic staining. These stains show as a metallic sheen on the worktop. If the worktop is not cleaned after every use and the stains are allowed to burn onto the surface, they may react with the glass and will no longer be removable. To help prevent such damage, clean the worktop after every use and apply a glass worktop conditioner.

Cleaning melts and spillovers

Anything that melts onto the ceramic glass surface or food spills with a high sugar content may cause pitting of the ceramic glass surface if they are left there to cool.

Examples include:

- plastic wrap
 - melted aluminum foil
 - sugar, sugary syrups, jams and jellies
 - vegetables and vegetable water with a high sugar content eg peas, sweet corn, beetroot. Remove these spills immediately with a special razor blade worktop scraper, taking care not to scratch the glass. Follow the steps below:
1. Turn the element off and carefully scrape the spill to a cool area of the worktop surface.
 2. Clean the spill up with a cloth or paper towel.
 3. As soon as the worktop is cool enough to safely touch, clean with worktop cleaner.

Cleaning the stainless steel surround strip

To remove fingerprints and other marks, wipe with a clean damp cloth and dry with a lint-free cloth.

Cleaning and Maintenance

Any piece of equipment works better and lasts longer when maintained properly and kept clean. Cooking equipment is no exception. Your range must be kept clean and maintained properly. Before cleaning, make sure all controls are in the "OFF" position. Disconnect power if you are going to clean thoroughly with water.

Surface Burner

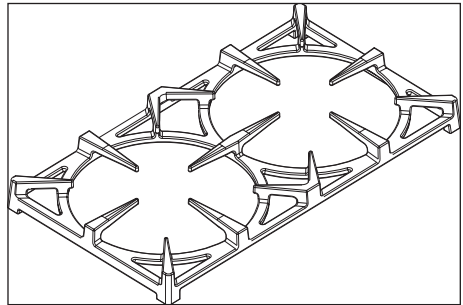
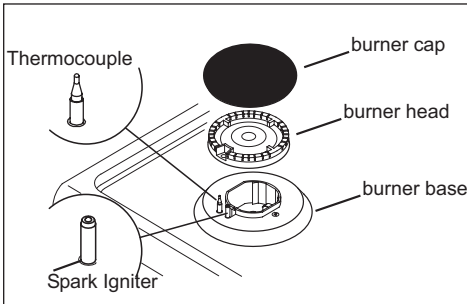

Cleaning and Maintenance

Wipe up spill-overs as soon as possible after they occur and before they get a chance to burn in and cook solid. In the event of a spill-over, follow these steps:

- Allow the burner and grate to cool to a safe temperature level.
- Lift off the burner grate. Wash in warm soapy water.
- Remove the burner cap and burner head and clean.

Burner Caps

The surface burner caps should be routinely removed and cleaned.

ALWAYS clean the burner caps after a spill-over. Keeping the burner caps clean will prevent improper ignition and uneven flames. To clean, pull burner cap straight up from the burner base. Wipe off surface burner caps with warm, soapy water and a soft cloth after each use. Use a non-abrasive cleanser and a soft brush or soft Scotch Brite™ pad for cooked-on foods. Dry thoroughly after cleaning. For best cleaning and to avoid possible rusting, **DO NOT** clean in dishwasher.

Burner Head

If ports on burner head are clogged, clean with a straight pin. **DO NOT** enlarge or distort the ports. **DO NOT** use a toothpick to clean the ports.

Burner Base

The base should be wiped regularly with hot soapy water at the end of each cooling period. **DO NOT** use steel wool, abrasive cloths, cleanser, or powders. To remove encrusted materials, soak the area with a hot towel to loosen the material, then use a wooden nylon spatula. **DO NOT** use a metal knife, spatula, or any other metal tool to scrape the aluminum base.

- Wipe up any spills which remain on the sealed top surface.
- Replace burner cap, burner head, and grates after drying thoroughly.

Control Panel

DO NOT use any cleaners containing ammonia or abrasives. They could remove the graphics from the control panel. Use hot, soapy water and a soft clean cloth.

Oven Surfaces

Several different finishes have been used in your oven. **NEVER USE AMMONIA, STEEL WOOL PADS OR ABRASIVE CLOTHS, CLEANSERS, OVEN CLEANERS, OR ABRASIVE POWDERS. THEY CAN PERMANENTLY DAMAGE YOUR OVEN.**

Cleaning and Maintenance

Control Knobs

MAKE SURE ALL THE CONTROL KNOBS POINT TO THE OFF POSITION BEFORE REMOVING. Pull the knobs straight off. Wash in detergent and warm water. Dry completely and replace by pushing firmly onto stem. **DO NOT** use any cleaners containing ammonia or abrasives. They could remove the graphics from the knob.

Stainless Steel Parts

All stainless steel body parts should be wiped regularly with hot soapy water at the end of each cooling period and with a liquid cleaner designed for that material when soapy water will not do the job. **DO NOT** use steel wool, abrasive cloths, cleansers, or powders. If necessary, scrape stainless steel to remove encrusted materials, soak the area with hot towels to loosen the material, then use a wooden or nylon spatula or scraper. **DO NOT** use a metal knife, spatula, or any other metal tool to scrape stainless steel. **DO NOT** permit citrus or tomato juice to remain on stainless steel surface, as citric acid will permanently discolor stainless steel. Wipe up any spills immediately.

Glass Surfaces

Clean with detergent and warm water. Glass cleaner can be used to remove fingerprints. If using glass cleaner ammonia, make sure that it does not run down on exterior door surface.

Oven Racks

Clean with detergent and hot water. Stubborn spots can be scoured with a soap-filled steel wool pad.



WARNING

BURN OR ELECTRICAL SHOCK HAZARD

Make sure all controls are OFF and oven is COOL before cleaning. Failure to do so can result in burns or electrical shock.



Replacing Oven Light

WARNING

ELECTRICAL SHOCK HAZARD



Disconnect the electric power at the main fuse or circuit breaker before replacing bulb.

WARNING

DO NOT touch bulb with bare hands. Clean off any signs of oil from the bulb and handle with a soft cloth.

DO NOT touch bulb with bare hands. Clean off any signs of oil from the bulb and handle with a soft cloth.

1. Unsnap glass light cover using a screwdriver in the access groove.
2. Firmly grasp light bulb and pull out.
3. Replace with halogen bulb using volt and wattage requirements listed on glass cover.
4. Replace the light cover by snapping glass cover onto metal box.
5. Reconnect power at the main fuse or circuit breaker.

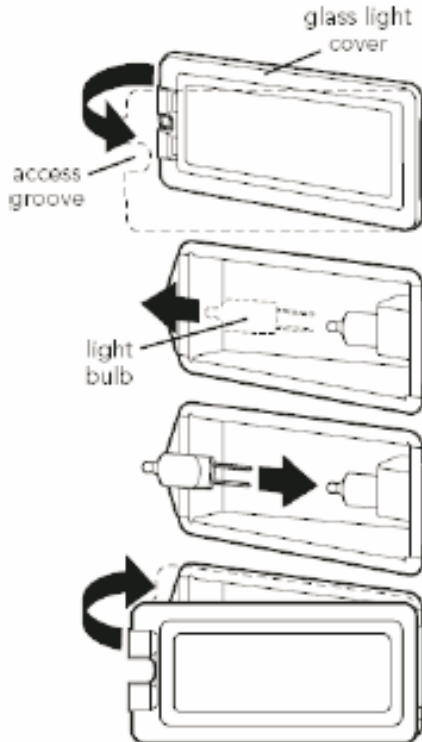

Door Glass Removal



WARNING

TO PREVENT PERSONAL INJURY

Before removing the doors, make sure the pins are properly installed in the hinges. Failure to do so can result in personal injury to hands and/or fingers.

The door can be completely disassembled to guarantee the general cleaning, of the glasses and the other parts. To disassemble the door you must observe the following procedure.



Open the door and fix the pins (one pin per hinge) as indicated in the picture 1(a,b)

2

3

4

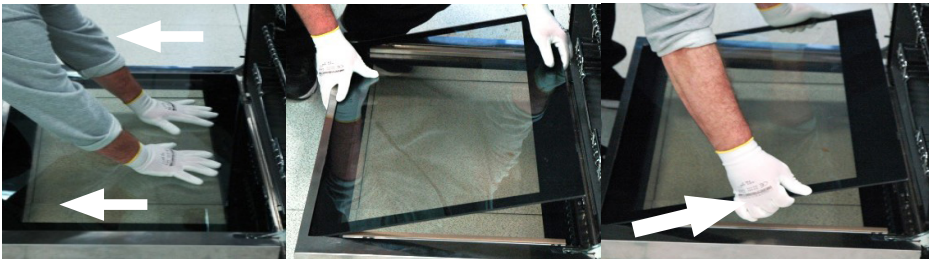

Put the hands on the internal glass surface, in the center; generate a small pressure and after slide back the glass, as indicated in picture 2. Grasp the glass, rotate and remove as indicated in the photos 3,4.

Door Replacement and Adjustment

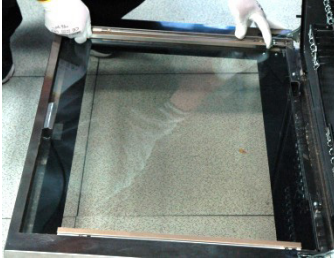

5

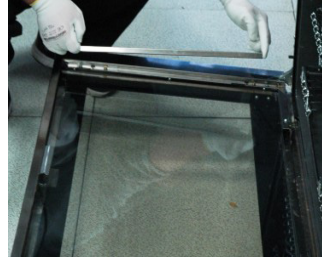

6

Grasp the bars and remove as indicated in the photos 5-6

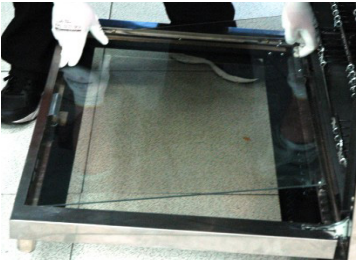

7

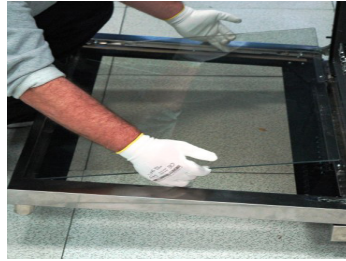

8

Grasp the intermediate glass, rotate and remove as indicated in the photos 7-8.

Assemble again the door repeat all the operations but exactly one after the other in the reverse sequence.

Before closing the door don't forget to remove the pins.

Troubleshooting

Problem	Possible Cause and /or Remedy
Range will not work.	Range is not connected to electrical power: Have electrician check power circuit breaker, wiring, and fuses.
Oven light will not work.	Light bulb is burned out. Range is not connected to power.
Igniters will not work.	Circuit is tripped. Fuse is blown. Range is not connected to power.
Igniters sparking but no flame ignition.	Gas supply is interrupted.
Igniters sparking continuously after flame ignition.	Power supply is not grounded. Power supply polarity is reversed. Igniters are wet or dirty.
Burner ignites but flame is large, distorted, or yellow.	Burner ports are clogged. Unit is being operated on wrong type of gas. Air shutters not properly adjusted.
Strong odor and/or smoke is noticed first few times oven is used.	This is normal burn off of insulation and protective oils in oven. This will go away after using oven a few times.

Service Information

If service is required, call your dealer or authorized service agency.

The name of the authorized service agency can be obtained from the dealer or distributor in your area, on calling 1-844-322-2111.

Have the following information readily available.

- Model number
- Serial number
- Date purchased
- Name of dealer from whom purchased.
- Clearly describe the problem that you are having.

Record the information indicated below.

You will need it if service is ever required.

The model and serial number can be found by looking in the last page of this booklet.

A duplicate label is located on the back side of the range.

Model no. _____ Serial no. _____

Date of purchase _____ Date installed _____

Dealer's name _____

Address _____

If service requires installation of parts, use only authorized parts to insure protection under warranty.

Keep this manual for future reference.

Labels

INSTALLATION LABEL

CONVERSION LABEL

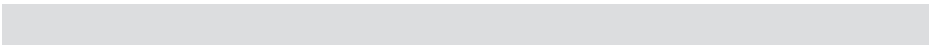

Tecnogas SUPERIORE

tecnogassuperiore.us