

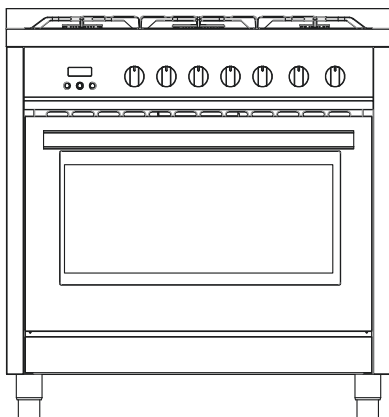

# GAS RANGE

**COS-965AGC**

**COS-965AGFC**

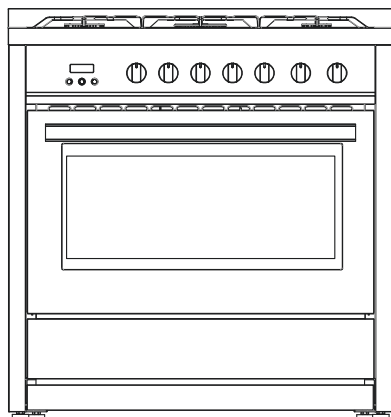

## 36-IN FREESTANDING RANGE

### USER MANUAL

**IMPORTANT:** READ AND SAVE THESE INSTRUCTIONS.  
FOR RESIDENTIAL USE ONLY.

**INSTALLER:** PLEASE LEAVE THIS GUIDE WITH THE HOMEOWNER.

**HOMEOWNER:** PLEASE KEEP THIS GUIDE FOR FUTURE REFERENCE.



# THANK YOU FOR YOUR PURCHASE

**Thank you for your purchase. We know that you have many brands and products to choose from and we are honored to know that you have decided to take one of our products into your home and hope that you enjoy it.**

COSMO Appliances are designed according to the strictest safety and performance standard for the North American market. We follow the most advanced manufacturing philosophy. Each appliance leaves the factory after thorough quality inspection and testing. Our distributors and our service partners are ready to answer any questions you may have regarding how to install, use and care for your products. We hope that this manual will help you learn to use the product in the safest and most effective manner.

**Before using this product, please read through this manual carefully.** Keep this user manual in a safe place for future reference. Please ensure that other persons using this product are familiar with these instructions as well.

If you have any questions or concerns, please contact the dealer from whom you purchased the product, or contact our Customer Support at:

**1-888-784-3108**

Reach us online at:

**[www.cosmoappliances.com](http://www.cosmoappliances.com)**

# TABLE OF CONTENTS

<b>RANGE SAFETY</b> .....	<b>3</b>
Anti-tip Device .....	4
Important Safety Instructions .....	6
<b>OVERVIEW</b> .....	<b>10</b>
Control Panel .....	12
Clock & Timer .....	12
Timed Cooking.....	14
<b>COOKTOP USE</b> .....	<b>16</b>
Power Failure .....	16
Cookware .....	17
<b>OVEN USE</b> .....	<b>18</b>
Oven Controls .....	18
Tips and Techniques .....	20
<b>RANGE CARE</b> .....	<b>22</b>
Cleaning.....	22
<b>TROUBLESHOOTING</b> .....	<b>25</b>
Baking Problems.....	25
Cooktop Problems.....	26
Oven Problems .....	28
<b>LIMITED WARRANTY</b> .....	<b>30</b>

## RANGE SAFETY

### WARNING



#### Fire Hazard

If the information in this manual is not followed exactly, a fire or explosion may result causing property damage, personal injury or death.

- Do not store or use gasoline or other flammable vapors and liquids in the vicinity of this or any other appliance.
- WHAT TO DO IF YOU SMELL GAS
  - Do not try to light any appliance.
  - Do not touch any electrical switch.
  - Do not use any phone in your building.
  - Clear the room, building, or area of all occupants.
  - Immediately call your gas supplier from a neighbor's phone. Follow the gas supplier's instructions.
  - If you cannot reach your gas supplier, call the fire department.
- Installation and service must be performed by a qualified installer, service agency or the gas supplier.

### WARNING

Never Operate the Top Surface Cooking Section of this Appliance Unattended.

- Failure to follow this warning statement could result in fire, explosion, or burn hazard that could cause property damage, personal injury, or death.
- If a fire should occur, keep away from the appliance and immediately call your fire department.

**DO NOT ATTEMPT TO EXTINGUISH AN OIL/GREASE FIRE WITH WATER**

## **WARNING**

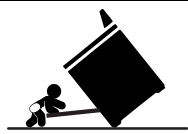

### **Tip Over Hazard**

- A child or adult can tip the range and be killed.
- Install anti-tip bracket to floor or wall per installation instructions.
- Slide range back so rear range foot is engaged in the slow of the anti-tip bracket.
- Re-engage the anti-tip bracket if range is moved.
- Do not operate the range without anti-tip bracket installed and engaged.
- Failure to follow these instructions can result in death or serious burns to children and adults.

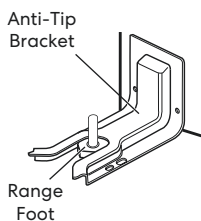

Making sure the anti-tip bracket is installed:

- Slide range forward.
- Look for the anti-tip bracket securely attached to floor and wall.
- Slide range back so rear range foot is under anti-tip bracket.

**WARNING:** Gas leaks cannot always be detected by smell.

Gas suppliers recommend that you use a gas detector approved by UL or CSA.

For more information, contact your gas supplier.

**WARNING:** Do not install a ventilation system that blows air downward toward this cooking appliance. This type of ventilation system may cause ignition and combustion problems with this cooking appliance resulting in personal injury or unintended operation.

**Your safety and the safety of others are very important.**

We have provided many important safety messages in this manual and on your appliance. Always read and obey all safety messages.



This is the safety alert symbol.

This symbol alerts you to potential hazards that can kill or hurt you and others.

All safety messages will follow the safety alert symbol and either the word "DANGER," "WARNING" or "CAUTION." These words mean:

 **DANGER**

You can be killed or seriously injured if you don't immediately follow instructions.

 **WARNING**

You can be killed or seriously injured if you don't follow instructions.

 **CAUTION**

A potentially hazardous situation which, if not avoided, could result in minor or moderate injury.

All safety messages will tell you what the potential hazard is, tell you how to reduce the chance of injury, and tell you what can happen if the instructions are not followed.

In the State of Massachusetts, the following installation instructions apply:

- Installations and repairs must be performed by a qualified or licensed contractor, plumber, or gasfitter qualified or licensed by the State of Massachusetts.
- If using a ball valve, it shall be a T-handle type.
- A flexible gas connector, when used, must not exceed 3 feet.

California Proposition 65 Warning

 **WARNING:**

Cancer and Reproductive Harm - [www.P65Warnings.ca.gov](http://www.P65Warnings.ca.gov).

# IMPORTANT SAFETY INSTRUCTIONS

**WARNING:** To reduce the risk of fire, electrical shock, injury to persons, or damage when using the range, follow basic precautions, including the following:

- |  |   |
|--|---|
| <ul style="list-style-type: none"><li>• <b>WARNING:</b> TO REDUCE THE RISK OF TIPPING OF THE RANGE, THE RANGE MUST BE SECURED BY PROPERLY INSTALLED ANTI-TIP DEVICES. TO CHECK IF THE DEVICES ARE INSTALLED PROPERLY, SLIDE RANGE COMPLETELY FORWARD, LOOK FOR ANTI-TIP BRACKET SECURELY ATTACHED TO THE FLOOR OR WALL, AND SLIDE RANGE BACK SO THE REAR RANGE FOOT IS UNDER ANTI-TIP BRACKET.</li><li>• <b>WARNING:</b> NEVER use this appliance as a space heater to heat or warm the room. Doing so may result in carbon monoxide poisoning and overheating of the oven.</li><li>• <b>WARNING:</b> NEVER cover any slots, holes or passages in the oven bottom or cover an entire rack with materials such as aluminum foil. Doing so blocks airflow through the oven and may cause carbon monoxide poisoning. Aluminum foil linings may also trap heat, causing a fire hazard.</li></ul> | <ul style="list-style-type: none"><li>• <b>CAUTION:</b> Do not store items of interest to children in cabinets above a range or on the back guard of a range – children climbing on the range to reach items could be seriously injured.</li><li>• Do Not Leave Children Alone – Children should not be left alone or unattended in area where range is in use. They should never be allowed to sit or stand on any part of the range.</li><li>• Wear Proper Apparel – Loose-fitting or hanging garments should never be worn while using the range.</li><li>• User Servicing – Do not repair or replace any part of the range unless specifically recommended in the manual. All other servicing should be referred to a qualified technician.</li><li>• Storage in or on Range – Flammable materials should not be stored in an oven or near surface units.</li><li>• This appliance is not intended for storage.</li></ul> |
|--|---|

**READ AND SAVE THESE INSTRUCTIONS**



# IMPORTANT SAFETY INSTRUCTIONS

- Do Not Use Water on Grease Fires – Smother fire or flame or use dry chemical or foam-type extinguisher.
- Use Only Dry Potholders – Moist or damp potholders on hot surfaces may result in burns from steam. Do not let potholder touch hot heating elements. Do not use a towel or other bulky cloth.
- Never Leave Surface Units Unattended at High Heat Settings – Boilover causes smoking and greasy spillovers that may ignite.
- Glazed Cooking Utensils – Only certain types of glass, glass/ceramic, ceramic, earthenware, or other glazed utensils are suitable for range-top service without breaking due to the sudden change in temperature.
- Utensil Handles Should Be Turned Inward and Not Extend Over Adjacent Surface Units – To reduce the risk of burns, ignition of flammable materials, and spillage due to unintentional contact with the utensil, the handle of a utensil should be positioned so that it is turned inward, and does not extend over adjacent surface units.
- Disconnect power before servicing.
- Proper Installation – The appliance, when installed, must be electrically grounded in accordance with local codes, or in the absence of local codes, with the National Electrical Code, ANSI/NFPA 70 or the Canadian Electrical Code, CSA C22.1-02. In Canada, the appliance must be electrically grounded in accordance with Canadian Electrical Code. Be sure your appliance is properly installed and grounded by a qualified technician.
- Injuries may result from misuse of appliance doors or drawers such as stepping, leaning, or sitting on the doors or drawers.
- Maintenance – Keep range area clear and free from combustible materials, gasoline, and other flammable vapors and liquids.
- Do not let cooking grease or other flammable materials accumulate in or near the range. Grease in the oven or on the cooktop may ignite.
- Top burner flame size should be adjusted so it does not extend beyond the edge of the cooking utensil. This instruction is based on safety considerations.

**READ AND SAVE THESE INSTRUCTIONS**

# IMPORTANT SAFETY INSTRUCTIONS

- Do not use replacement parts that have not been recommended by the manufacturer (e.g. parts made at home using a 3D printer).
- Clean Cooktop With Caution – If a wet sponge or cloth is used to wipe spills on a hot cooking area, be careful to avoid steam burn. Some cleaners can produce noxious fumes if applied to a hot surface.
- Use Care When Opening Door – Let hot air or steam escape before removing or replacing food.
- Do Not Heat Unopened Food Containers – Build-up of pressure may cause container to burst and result in injury.
- Keep Oven Vent Ducts Unobstructed.
- Never broil with door open. Open-door broiling is not permitted due to overheating of control knobs.
- Placement of Oven Racks – Always place oven racks in desired location while oven is cool. If rack must be moved while oven is hot, do not let potholder contact hot heating element in oven.
- Care must be taken to prevent aluminum foil and meat probes from contacting heating elements.
- **DO NOT TOUCH HEATING ELEMENTS OR INTERIOR SURFACES OF OVEN** – Heating elements may be hot even though they are dark in color. Interior surfaces of an oven become hot enough to cause burns. During and after use, do not touch, or let clothing or other flammable materials contact heating elements or interior surfaces of oven until they have had sufficient time to cool. Other surfaces of the appliance may become hot enough to cause burns – among these surfaces are cooktop, burners, grates, oven vent openings and surfaces near these openings, oven doors, windows of oven doors, and crevices around the oven doors.
- Top burner flame size should be adjusted so it does not extend beyond the edge of the cooking utensil.
- Have the installer show you the location of the range gas shut-off valve and how to turn it off if necessary.

**READ AND SAVE THESE INSTRUCTIONS**

# IMPORTANT SAFETY INSTRUCTIONS

- Proper Disposal of Your Appliance – Dispose of or recycle your appliance in accordance with Federal and Local Regulations. Contact your local authorities for the environmentally safe disposal or recycling of your appliance.

## **For units with ventilating hood –**

- Clean Ventilating Hoods Frequently – Grease should not be allowed to accumulate on hood or filter.
- When flambé cooking under the vent hood, turn the fan on.

## **For self-cleaning ranges –**

- Do Not Clean Door Gasket – The door gasket is essential for a good seal. Care should be taken not to rub, damage, or move the gasket.
- Do Not Use Oven Cleaners – No commercial oven cleaner or oven liner protective coating of any kind should be used in or around any part of the oven.
- Clean Only Parts Listed in Manual.
- Before Self-Cleaning the Oven – Remove broiler pan and other utensils. Wipe off all excessive spillage before initiating the cleaning cycle.

**READ AND SAVE THESE INSTRUCTIONS**

# OVERVIEW

## RANGE LAYOUT

This illustration covers several different models. The range you have purchased may have some or all of the items listed. The locations and appearances of the features shown here may not match those of your model.

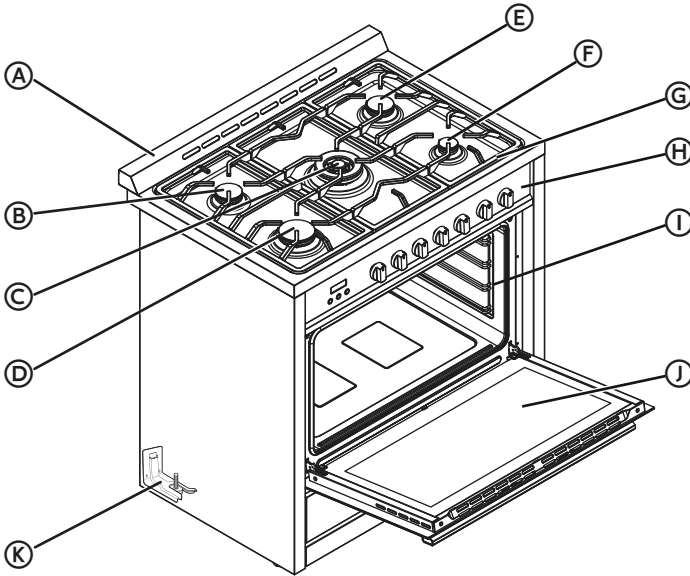

- |                        |                          |
|------------------------|--------------------------|
| (A) Backsplash         | (G) Surface burner grate |
| (B) Semi-rapid burner  | (H) Control panel        |
| (C) Triple ring burner | (I) Oven rack positions  |
| (D) Rapid burner       | (J) Oven door window     |
| (E) Semi-rapid burner  | (K) Anti-tip bracket     |
| (F) Auxiliary burner   |                          |

## WHAT'S INCLUDED

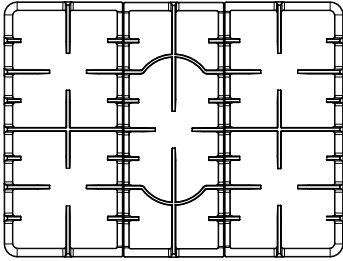

Surface burner grates (3)

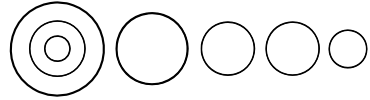

Surface burners and caps (5)

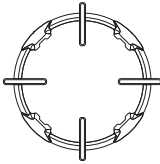

Wok grate

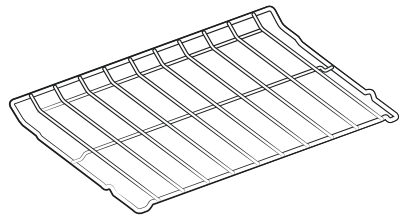

Oven racks (2)

## BURNER LAYOUT

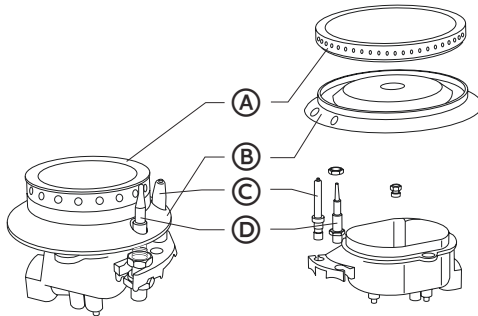

- (A) Burner cap
- (B) Burner head

- (C) Electrode
- (D) Flame failure safety device  
(on older models)

# CONTROL PANEL

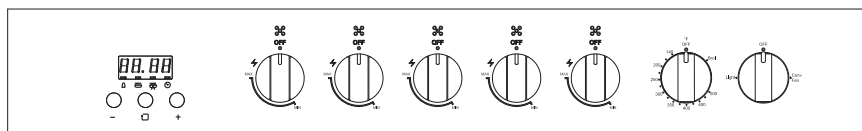

Clock/Timer  
Controls

Surface Burner  
Controls

Oven  
Controls

# CLOCK & TIMER

## SETTING THE CLOCK AND TIMER

**IMPORTANT:** Clock must be set in order for the timed oven functions to work.

Your model has a digital display clock with 3 control buttons.

**NOTE:** In the event of a power failure, all settings including the clock time set will be lost. When the power is returned, clock must be set again.

## TO SET THE TIME OF DAY

When the power is connected or after a power outage, the screen will display 12.00 and the indicator bar above ☺ "Set Clock" will blink.

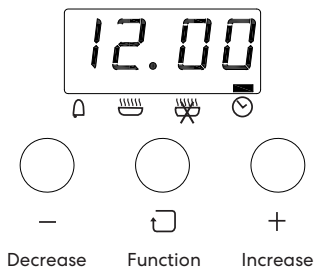

1. If the clock was previously set, press the function button repeatedly until the indicator bar blinks above ☹ "Set Clock".
2. Press or hold the + or - button to adjust the clock. The clock will be confirmed automatically if you leave the correct time there for 5 seconds without pressing any buttons, and the indicator bar will become solid. You may also press the function button to confirm the clock manually while the indicator bar is blinking.

## TO SET THE TIMER

The digital countdown timer can be set up to 11 hours and 59 minutes maximum.

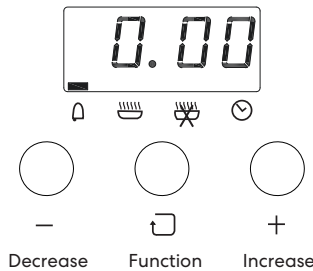

1. Press the function button repeatedly until the indicator bar blinks above ⚠ "Timer Set".
2. Press or hold the + or - button to set the length of time, then press the function button or wait for 5 seconds to confirm.

Once confirmed, the current time will be shown and the countdown will begin. When the countdown is finished, press any button to stop the beeping.

To view and modify the countdown time remaining, press the function button once to select ⚠ "Timer Set" again and use the + or - button to adjust the current timer as needed; To cancel the timer, follow the steps above to set the length of time to 0.00.

**NOTE:** When adjusting the time, idling for 5 seconds without pressing any buttons will automatically confirm the current time on the display.

## TIMED COOKINGS

### ⚠ WARNING

#### Food Poisoning Hazard

Do not let food sit in oven more than one hour before or after cooking. Doing so can result in food poisoning or sickness.

Foods that can easily spoil such as milk, eggs, fish, meat or poultry, should be chilled in the refrigerator first. Even when chilled, they should not stand in the oven for more than 1 hour before cooking begins, and should be removed promptly when finished cooking.

- **Set Cook Time only:**

Cook for the set length of time from now, then shut off the oven automatically.

- **Set End Time only:**

Shut off the oven automatically at the set time of day.

**NOTE:** Only one of Cook Time and End Time can be used at a time.

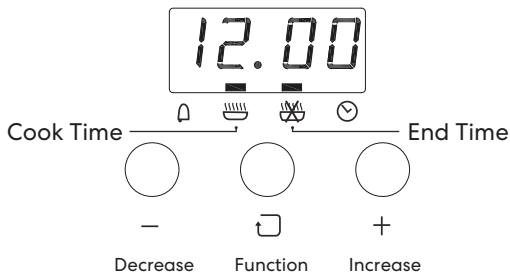

**IMPORTANT:** Clock must be set in order for the timed oven functions to work.

### TO SET THE COOK TIME

Press the function button until the bar flashes above "Cook Time". Then use the + or - button to set the length of cooking time (maximum of 10 hours), and press the function button or wait for 5 seconds to confirm.



## TO SET THE END TIME

Press the function button until the bar flashes above  "End Time". Then use the + or – button to set the shut off time of day, and press the function button or wait for 5 seconds to confirm.

## SETTING THE COOKING METHODS

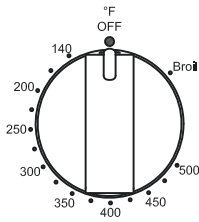

Thermostat (°F)

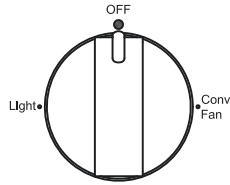

Cooking Mode

Turn the oven Thermostat knob and Cooking-Mode knobs to set the temperature and oven mode. The oven will turn on, and will automatically shut off according to the time set. When the shut off time is reached, press any button to stop the beeping and return the oven knobs to the OFF position.

### Example:

Start/Continue baking at 350°F for 50 minutes and finish cooking at 6:00.

1. Press the function button repeatedly until the indicator bar blink above  "Cook Time", then set the length of cooking time to 0.50 and confirm.

**OR**

Press the function button repeatedly until the indicator bar blink above  "End Time", then set the shut off time of day to 6.00 and confirm.

2. Turn/Keep the thermostat knob at 350°. Once the clock time is returned on the display, the indicator bar above "Cook Time" or "End Time" will be blinking, indicating a schedule is set.
3. At 6:00 when the cooking is finished, the oven will shut down automatically. Press any button to stop the beeping, and turn the oven knobs to the OFF position.

## COOKTOP USE

Read the instructions before installing or using this appliance.

- This appliance shall be installed in accordance with the regulations in force and only used in a well-ventilated space.
- The use of a gas-cooking appliance results in the production of heat and moisture in the room in which it is installed. Ensure that the kitchen is well ventilated: keep natural ventilation holes open or install a mechanical ventilation device (mechanical extractor hood).
- Prolonged intensive use of the appliance may call for additional ventilation, for example opening of a window, or more effective ventilation, for example increasing the level of mechanical ventilation where present.

### IGNITION AND OPERATION OF THE BURNERS

To ignite a burner, push down on the burner knob and rotate it counterclockwise until the knob indicator is aligned with the ⚡ ignite icon. Release the knob and adjust the flame intensity by further rotating the knob counterclockwise from MAX (maximum) to MIN (minimum).

**NOTE:** For models with a flame failure safety device - Once the flame is lit, hold the knob depressed for about 3-4 seconds until the device keeps the burner automatically lit. If the burner fails to ignite, wait one minute for the gas to dissipate before attempting to reignite.

To turn off the burner, rotate the knob clockwise until the indicator on the knob is aligned with OFF.

### POWER FAILURE

In case of prolonged power failure, the surface burners can be lit manually. Hold a lit match near a burner and turn knob counterclockwise until the indicator is aligned with MAX. After the burner is lit, turn knob to desired setting.

In the case of unintentional flame extinguishing, the safety valve intervenes by shutting off the gas to the burners.

The electric igniter must not be actuated for longer than 15 seconds. Should the burner not light, or should the burner be unintentionally turned off, immediately close the burner, and wait at least 1 minute before repeating. Once ignited, adjust the flame as desired.

For lower gas consumption and a better result, use saucepans with a diameter matching the diameter of the burner, to avoid the flame coming up around the sides of the saucepan. See the Container Table. Use only flat-bottomed pans.

As soon as liquid starts to boil, turn the flame down to a level sufficient to maintain boiling.

## COOKWARE

### MATCH PAN DIAMETER TO FLAME SIZE

The flame should be the same size as the bottom of the pan or smaller. Do not use small pans with high flame settings as the flames can lick up the sides of the pan. Oversized pans that span two burners are placed front to rear, not side to side.

### USE BALANCED PANS

Pans must sit level on the cooktop grate without rocking. Center the pan over the burner.

### USE A LID THAT FITS PROPERLY

A well-fitting lid helps shorten the cooking time. Flat, heavy bottom pans provide even heat and stability.

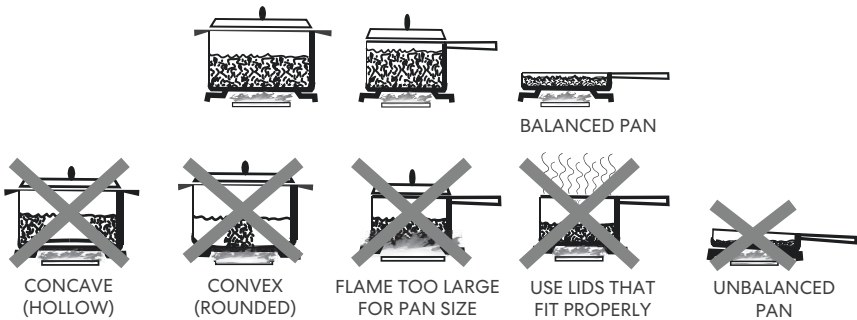

## CONTAINER TABLE

Burner	Min Saucepan	Max Saucepan
Auxiliary	3.5" (9.0 cm)	6.3" (16 cm)
Semi-rapid	5.1" (13 cm)	7.1" (18 cm)
Rapid	5.9" (15 cm)	10.2" (26 cm)
Triple ring	8.3" (21 cm)	10.2" (26 cm)

## OVEN USE

### **⚠ WARNING**

NEVER cover any slots, holes or passages in the oven bottom or cover an entire rack with materials such as aluminum foil. Doing so blocks airflow through the oven and may cause carbon monoxide poisoning. Aluminum foil linings may also trap heat, causing a fire hazard.

Reset all controls to the OFF position after using a programmable timing operation. No attempt should be made to operate the appliance during power failure.

An air curtain or other overhead range hood, which operates by blowing a downward airflow onto a range shall not be used in conjunction with a gas range.

### OVEN CONTROLS

The Thermostat knob and Cooking-mode knobs are used together to select Oven Modes.

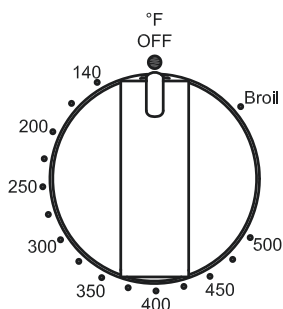

Thermostat (°F)

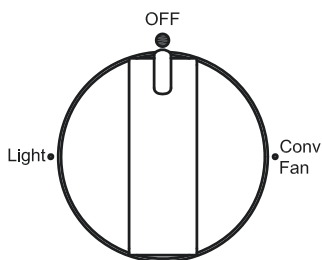

Cooking Mode

### THERMOSTAT KNOB

Push in on the Thermostat knob, and then turn the knob to any baking temperature or broil to automatically ignite the bake burner or the broil burner.

## **Bake**

THERMOSTAT RANGE: 140°F (60°C) TO MAX 500°F (260°C)

The Bake mode uses heat from the lower element to cook food. When using this mode to prepare baked goods such as cakes, cookies and pastries, always preheat the oven first and place food centrally near the middle racks.

## **Broil**

THERMOSTAT RANGE: Broil

The Broil mode uses intense heat from the upper element to sear foods. Ideal for toasting, melting cheese, browning and searing surface. Food should be placed near the upper racks, and should not be cooked for too long on each side of the food. It is not necessary to preheat when using this mode.

**NOTE:** Except for timed cooking, the oven will remain on until the Thermostat knob is returned to the OFF position.

## **COOKING-MODE KNOB**

### **Light**

The Light mode turns on oven light inside the oven.

### **Conv Fan (Convection Fan)**

The Convection Fan mode uses air movement from the fan to enhance cooking evenness across multiple racks. Cooking times may be slightly longer for multiple racks than what would be expected for a single rack.

**For video instructions on how to use your range, scan QR Code:**



## TIPS AND TECHNIQUES

### Bake

Baking is cooking with heated air. Both upper and lower elements in the oven are used to heat the air but no fan is used to circulate the heat.

Follow the recipe or convenience food directions for baking temperature, time and rack position. Baking time will vary with the temperature of ingredients and the size, shape and finish of the baking utensil.

### General Guidelines

- For best results, bake food on a single rack with at least 1" - 1½" (2.5 - 3 cm) space between utensils and oven walls.
- Use one rack when selecting the bake mode.
- Check for doneness at the minimum time.
- Use metal bake ware (with or without a non-stick finish), heatproof glass, glass-ceramic, pottery or other utensils suitable for the oven.
- When using heatproof glass, reduce temperature by 25°F (15°C) from recommended temperature.
- Use baking sheets with or without sides or jelly roll pans.
- Dark metal pans or nonstick coatings will cook faster with more browning. Insulated bake ware will slightly lengthen the cooking time for most foods.
- Do not use aluminum foil or disposable aluminum trays to line any part of the oven. Foil is an excellent heat insulator and heat will be trapped beneath it. This will alter the cooking performance and can damage the finish of the oven.
- Avoid using the opened door as a shelf to place pans.
- See Troubleshooting for tips to Solving Baking and Roasting Problems.

## BAKE CHART

FOOD ITEM	RACK POSITION	TEMP. °F (°C) (PREHEATED OVEN)	TIME (MIN)
<b>Cake</b>			
Cupcakes	2	350 (175)	19-22
Bundt Cake	1	350 (175)	40-45
Angel Food	1	350 (175)	35-39
<b>Pie</b>			
2 crust, fresh, 9"	2	375-400 (190-205)	45-50
2 crust, frozen fruit, 9"	2	375 (190)	68-78
<b>Cookies</b>			
Sugar	2	350-375 (175-190)	8-10
Chocolate Chip	2	350-375 (175-190)	8-13
Brownies	2	350 (175)	29-36
<b>Breads</b>			
Yeast bread loaf, 9x5	2	375 (190)	18-22
Yeast rolls	2	375-400 (190-205)	12-15
Biscuits	2	375-400 (190-205)	7-9
Muffins	2	425 (220)	15-19
<b>Pizza</b>			
Frozen	2	400-450 (205-235)	23-26
Fresh	2	475 (246)	15-18

# RANGE CARE

## CLEANING

**IMPORTANT:** Before cleaning, make sure all controls are off and the oven and cooktop are cool. Always follow label instructions on cleaning products. Soap, water and a soft cloth or sponge are suggested first unless otherwise noted. Do not use abrasive cleaning products.

### EXTERIOR PORCELAIN ENAMEL SURFACES

- Food spills containing acids, such as vinegar and tomato, should be cleaned as soon as the entire appliance is cool. These spills may affect the finish.

#### Cleaning Method:

- Glass cleaner, mild liquid cleaner or nonabrasive scrubbing pad: Gently clean around the model and serial number plate because scrubbing may remove numbers.

### EXTERIOR STAINLESS STEEL

**NOTE:** Do not use soap-filled scouring pads, abrasive cleaners, Cooktop Polishing Cream, steel-wool pads, gritty washcloths or some paper towels. Damage may occur, even with one-time or limited use.

- Rub in direction of grain to avoid damaging.

#### Cleaning Methods:

- Liquid detergent or all-purpose cleaner: Rinse well with clean water and dry with soft, lint-free cloth.
- Stainless Steel Cleaner and Polish. Vinegar for hard water spots.

### OVEN DOOR EXTERIOR

#### Cleaning Method:

- Glass cleaner and paper towels or nonabrasive plastic scrubbing pad: Apply glass cleaner to soft cloth or sponge, not directly on panel.



## **PORCELAIN-COATED GRATES AND CAPS**

- Clean as soon as cooktop, grates and caps are cool.
- Food spills containing acids, such as vinegar and tomato, should be cleaned as soon as the cooktop grates and caps are cool. These spills may affect the finish.
- To avoid chipping, do not bang grates and caps against each other or hard surfaces such as cast iron cookware.
- Do not reassemble caps on burners while wet.

### **Cleaning Method:**

- Nonabrasive plastic scrubbing pad and mildly abrasive cleanser.

## **BURNER SPREADER**

### **Cleaning Method:**

- Wash the burner spreader frequently with boiling water and detergent to remove any deposits which could block the flame outlet.
- Before reinstalling, dry the burner spreader thoroughly so the burner will ignite properly.

## **COOKTOP CONTROL KNOBS**

- Pull knobs straight away from control panel to remove.
- When replacing knobs, make sure knobs are in the Off position.

### **Cleaning Method:**

- Soap and water or dishwasher.

**NOTE:** Do not use steel wool, abrasive cleansers or oven cleaner. Do not soak knobs.

## **CONTROL PANEL**

### **Cleaning Method:**

- Glass cleaner and soft cloth or sponge: Apply glass cleaner to soft cloth or sponge, not directly on panel.

**NOTE:** Do not use abrasive cleaners, steel-wool pads, gritty washcloths or some paper towels. Damage may occur.

## **OVEN CAVITY**

- Food spills should be cleaned when oven cools. At high temperatures, foods react with porcelain, so staining, etching, pitting or faint white spots can result.

### **Cleaning Method:**

- Mild detergent and warm water.

**NOTE:** Do not use oven cleaners.

## **OVEN RACKS AND ROASTING RACKS**

### **Cleaning Method:**

- Steel-wool pad

## **2-PIECE BROILER PAN**

### **Cleaning Method:**

- Mildly abrasive cleanser: Scrub with wet scouring pad.
- Solution of ½ cup (125 mL) ammonia to 1 gal. (3.75 L) water: Soak for 20 minutes, and then scrub with scouring or steel-wool pad.
- Oven cleaner: Follow product label instructions.

### **Porcelain enamel only, not chrome**

- Dishwasher

# TROUBLESHOOTING

First try the solutions suggested here to possibly avoid the cost of a service call.

## BAKING PROBLEMS

With any oven setting poor results can occur for many reasons other than a malfunction of the oven. Check the chart below for causes of the most common problems. Since the size, shape and material of baking utensils directly affect the baking results, the best solution may be to replace old baking utensils that have darkened and warped with age and use.

PROBLEM	CAUSE
<b>Food browns unevenly</b>	<ul style="list-style-type: none"><li>• Oven not preheated</li><li>• Aluminum foil on oven rack or oven bottom</li><li>• Baking utensil too large for recipe</li><li>• Pans touching each other or oven walls</li></ul>
<b>Food too brown on bottom</b>	<ul style="list-style-type: none"><li>• Oven not preheated</li><li>• Using glass, dull or darkened metal pans</li><li>• Incorrect rack position</li><li>• Pans touching each other or oven walls</li></ul>
<b>Food is dry or has shrunk excessively</b>	<ul style="list-style-type: none"><li>• Oven temperature too high</li><li>• Baking time too long</li><li>• Oven door opened frequently</li><li>• Pan size too large</li></ul>
<b>Food is baking or roasting too slowly</b>	<ul style="list-style-type: none"><li>• Oven temperature too low</li><li>• Oven not preheated</li><li>• Oven door opened frequently</li><li>• Tightly sealed with aluminum foil</li><li>• Pan size too small</li></ul>

PROBLEM	CAUSE
<b>Pie crusts do not brown on bottom or crust is soggy</b>	<ul style="list-style-type: none"> <li>• Baking time not long enough</li> <li>• Using shiny steel pans</li> <li>• Incorrect rack position</li> <li>• Oven temperature is too low</li> </ul>
<b>Cakes pale, flat and may not be done inside</b>	<ul style="list-style-type: none"> <li>• Oven temperature too low</li> <li>• Incorrect baking time</li> <li>• Cake tested too soon</li> <li>• Oven door opened too often</li> <li>• Pan size may be too large</li> </ul>
<b>Cakes high in middle with crack on top</b>	<ul style="list-style-type: none"> <li>• Oven temperature too high</li> <li>• Baking time too long</li> <li>• Pans touching each other or oven walls</li> <li>• Incorrect rack position</li> <li>• Pan size too small</li> </ul>
<b>Pie crust edges too brown</b>	<ul style="list-style-type: none"> <li>• Oven temperature too high</li> <li>• Edges of crust too thin</li> </ul>

## COOKTOP PROBLEMS

PROBLEM	POSSIBLE CAUSE	SOLUTION
<b>Burner will not ignite</b>	There is no power to the range.	Make sure electrical plug is plugged into a live, properly grounded outlet. Replace the fuse or reset the circuit breaker.
<b>Burner will not operate</b>	First time use. Air still in the gas line.	Turn on any one of the surface burner knobs to release air from the gas lines.
	Control knob is not set correctly.	Push in knob before turning to a setting.
	The burner port is clogged.	Clean burner port opening using a stiff, nylon toothbrush or a straightened paper clip.

<b>PROBLEM</b>	<b>POSSIBLE CAUSE</b>	<b>SOLUTION</b>
<b>Burner Flames are uneven, yellow and/or noisy</b>	Burner port(s) are clogged.	Clean burner port opening using a stiff, nylon toothbrush or a straightened paper clip.
	Burner caps are not positioned properly.	Place burner caps so that the alignment pins are properly aligned with the slots.
	Propane gas is being used.	The range should be converted to LP gas by a qualified technician.
<b>Burner flame is too high or too low</b>	Cooktop gas supply is not correct.	Ensure the range is set for the correct gas type. It is factory set for natural gas. If connecting to LP gas, the burners should be converted to LP gas with the orifice kit supplied and the pressure regulator converted to the LP gas setting by a qualified technician.
	The gas pressure is not correct.	Make sure the pressure regulator is installed correctly and the gas line pressure is correct. See Installation Instructions.
<b>Burner makes popping noises</b>	The burner is wet.	Allow the burner to dry before using.
	The burner cap or gas spreader is not positioned correctly.	Place burner caps so that the alignment pins are properly aligned with the slots.
<b>Excessive heat around cookware on cooktop</b>	The cookware is not the proper size for the burner.	Use cookware with a bottom surface approximately the same size as the cooking area and burner. Cookware should not extend more than 1" (2.5 cm) outside the cooking area. Adjust the flame so that it does not come up around the cookware.
<b>Cooking results are not what expected</b>	Using incorrect cookware.	See the "Cookware" section.
	The control knob is not set to the proper heat level.	See the "Controls" section.

## OVEN PROBLEMS

PROBLEM	POSSIBLE CAUSE	SOLUTION
<b>Oven is not heating</b>	No power to the range.	Check the circuit breaker or fuse box to your house. Make sure there is proper electrical power to the oven.
	Oven control not turned on.	Make sure the oven temperature has been selected.
<b>Oven is not cooking evenly</b>	Not using the correct bake ware or oven rack position.	Refer to cook charts for recommended rack position. Always reduce recipe temperature by 25 °F (15 °C) when baking with Convention Bake mode.
<b>Oven display stays Off</b>	Power interruption.	Turn off power at the main power supply (fuse or breaker box). Turn breaker back on. If condition persists, call for service.
<b>Cooling fan continues to run after oven is turned off</b>	The electronic components have not yet cooled sufficiently.	The fan will turn off automatically when the electronic components have cooled sufficiently.
<b>Oven light is not working properly</b>	Light bulb loose or burned-out.	Reinsert or replace the light bulb. Touching the bulb with fingers may cause the bulb to burn out.
<b>Oven light stays on</b>	Door is not closing completely	Check for obstruction in oven door. Check to see if hinge is bent or door switch broken.
<b>Cannot remove lens cover</b>	Soil build-up around the lens cover.	Wipe lens cover area with a clean, dry towel prior to attempting to remove the lens cover.
<b>Clock and timer are not working properly</b>	No power to the range.	Check the circuit breaker or fuse box to your house. Make sure there is proper electrical power to the oven.

PROBLEM	POSSIBLE CAUSE	SOLUTION
<b>Excessive Moisture</b>		When using bake mode, preheat the oven first. Convection Bake and Convection Roast will eliminate any moisture in the oven.
<b>Porcelain Chips</b>	Porcelain interior is chipped by oven racks	When removing and replacing oven racks, always tilt racks upward and do not force them to avoid chipping the porcelain.

# LIMITED WARRANTY

## WARRANTY AND SERVICE

TO RECEIVE WARRANTY SERVICE, YOUR PRODUCT MUST BE REGISTERED.

TO REGISTER AND REVIEW FULL WARRANTY DETAILS, VISIT:

**[WWW.COSMOAPPLIANCES.COM/WARRANTY](http://WWW.COSMOAPPLIANCES.COM/WARRANTY)**

SCAN TO REGISTER

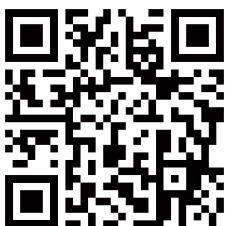

## CUSTOMER SUPPORT

TO CHAT WITH US LIVE FOR ASSISTANCE, VISIT:

**[WWW.COSMOAPPLIANCES.COM/CHAT](http://WWW.COSMOAPPLIANCES.COM/CHAT)**

SCAN TO CHAT





## **IMPORTANT**

### **Do Not Return This Product To The Store**

If you have a problem with this product, please contact COSMO Customer Support at

**+1 (888) 784-3108**

DATED PROOF OF PURCHASE, MODEL #, AND SERIAL # REQUIRED FOR WARRANTY SERVICE.

## **IMPORTANT**

### **Ne pas Réexpédier ce Produit au Magasin**

Pour tout problème concernant ce produit, veuillez contacter le service des consommateurs Cosmo Customer Support au

**+1 (888) 784-3108**

UNE PREUVE D'ACHAT DATEE EST REQUISE POUR BENEFICIER DE LA GARANTIE.

## **IMPORTANTE**

### **No regrese este producto a la tienda**

Si tiene algún problema con este producto, por favor contacte el ayuda al cliente COSMO al

**+1 (888) 784-3108**

(Válido solo en E.U.A.)

NECESITA UNA PRUEBA DE DE COMPRA FECHADA, NÚMERO DE MODELO Y DE SERIE PARA EL SERVICIO DE LA GARANTÍA.



#### **Correct Disposal of this product:**

This marking indicates that this appliance should not be disposed with other household wastes. To prevent possible harm to the environment or human health from uncontrolled waste disposal, recycle it responsibly to promote the sustainable reuse of material resources.

# MEMO

A series of horizontal dashed lines for writing.





APPLIANCES

Cosmo is constantly making efforts to improve the quality and performance of our products, so we may make changes to our appliances without updating this manual.

Electronic version of this manual is available at:  
[www.cosmoappliances.com](http://www.cosmoappliances.com)